

APPENDICE 1

Outputs grafici e numerici delle simulazioni effettuate in regime di moto vario con il software Hec-Ras.

Botro Quercetano

Stato attuale



1) A TR200 2) A TR30

← quercetano quercetano →

N.B. in grigio sono indicati gli sfioratori laterali in destra idrografica

Legend

- WS Max WS - A TR200
- WS Max WS - A TR30
- Ground

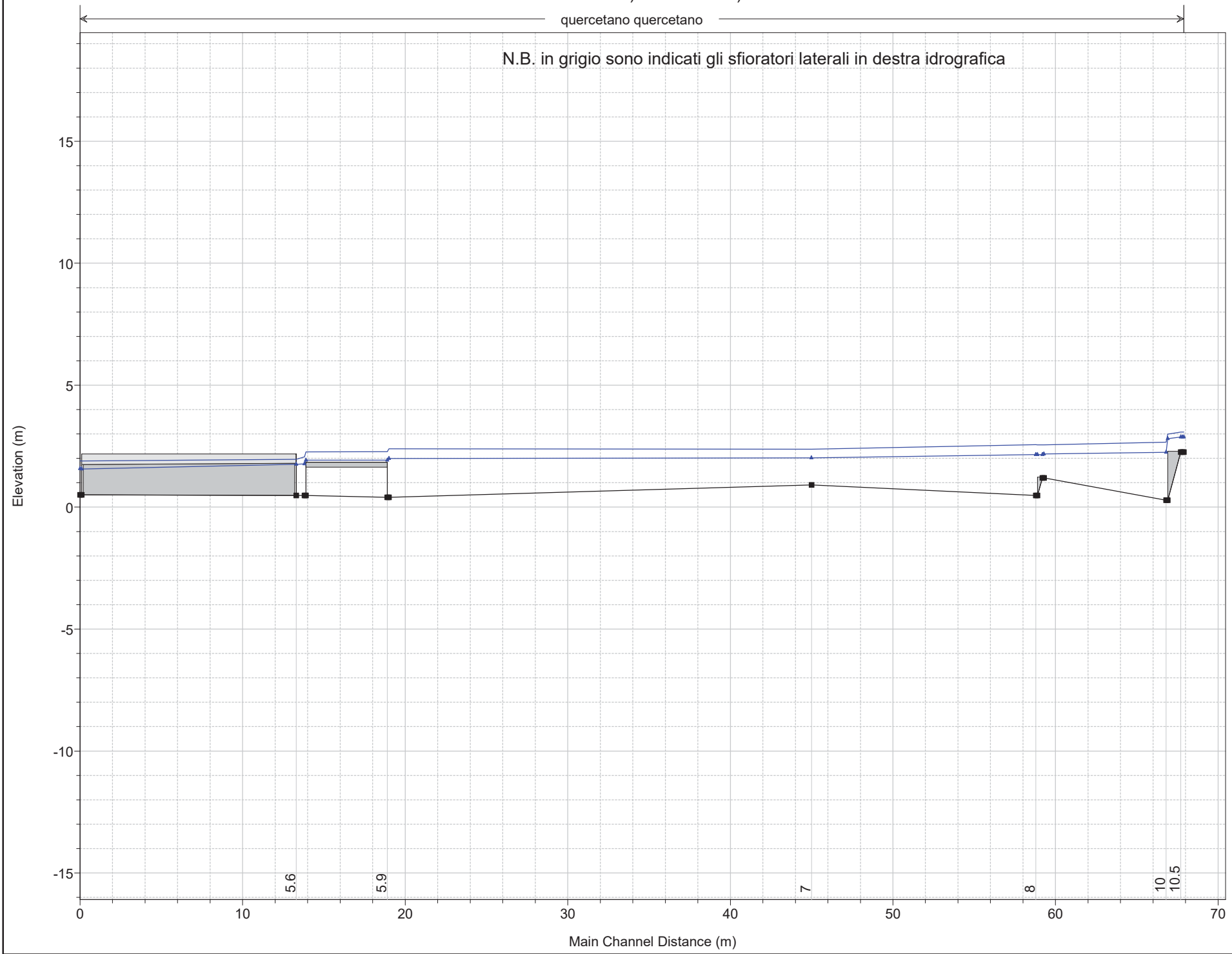

1 cm Horiz. = 3 m 1 cm Vert. = 2 m

1) A TR200 2) A TR30

← quercetano quercetano →

N.B. in grigio sono indicati gli sfioratori laterali in sinistra idrografica

Legend

- WS Max WS - A TR200
- WS Max WS - A TR30
- Ground

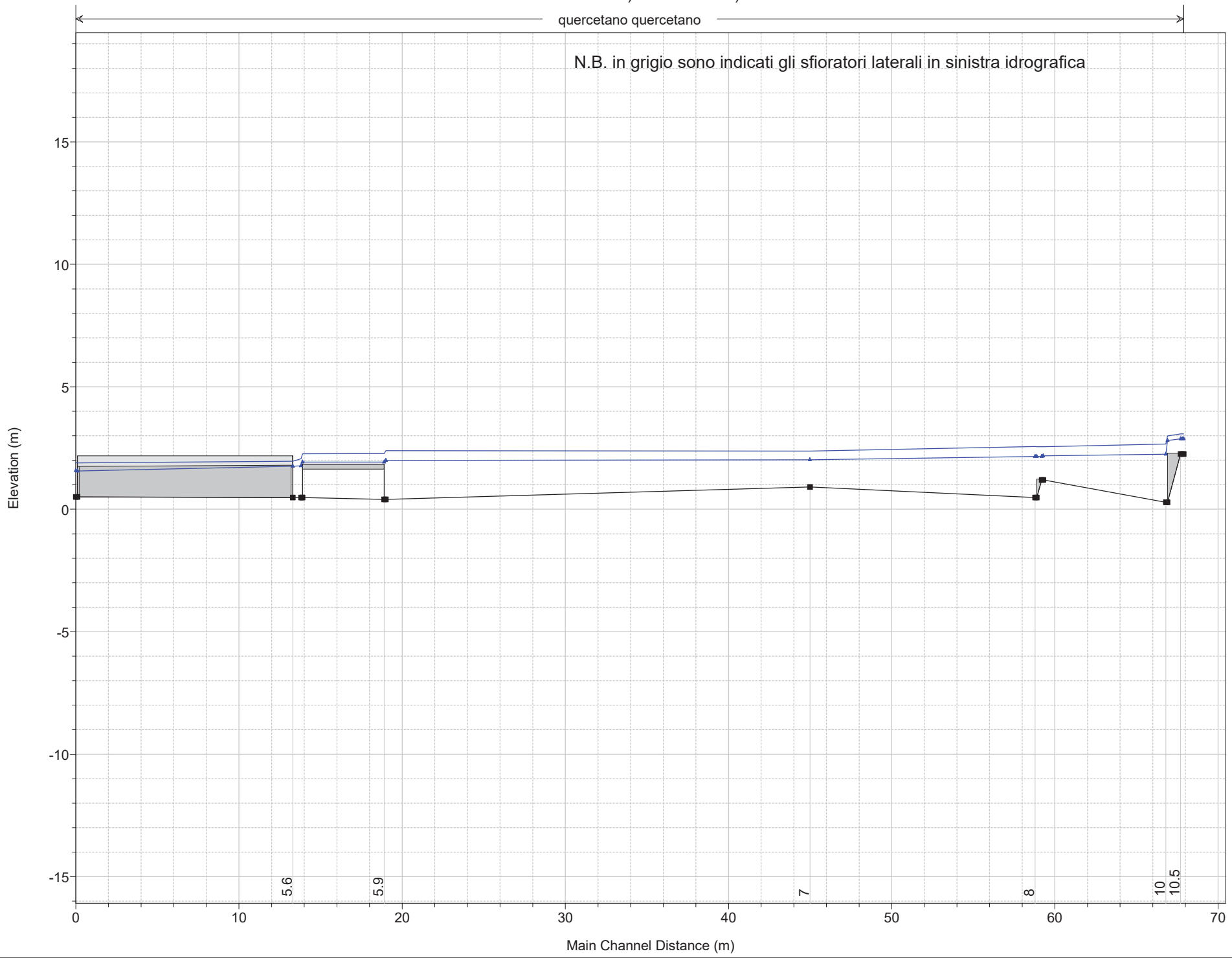

1 cm Horiz. = 3 m 1 cm Vert. = 2 m

1) A TR200 2) A TR30
River = quercetano Reach = quercetano RS = 11 sez 5 m rilievo

← .035 → * ← .03 →

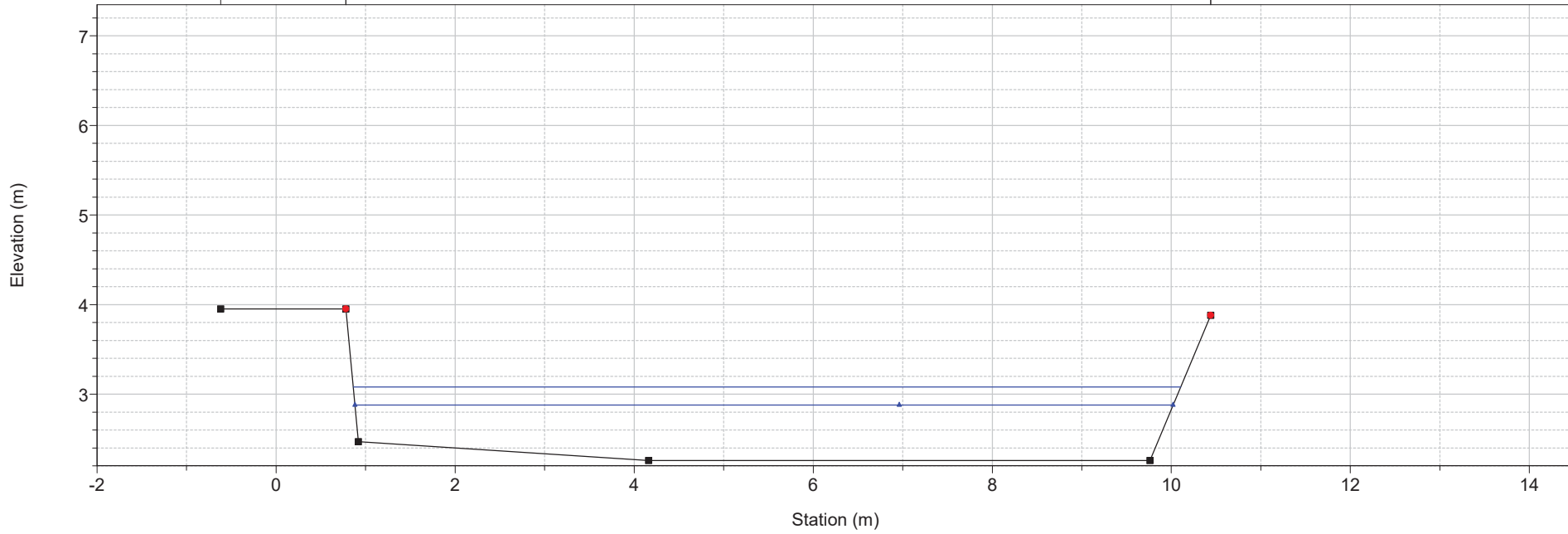

1) A TR200 2) A TR30
River = quercetano Reach = quercetano RS = 10.8 sez 5 m rilievo

← .035 → * ← .03 →

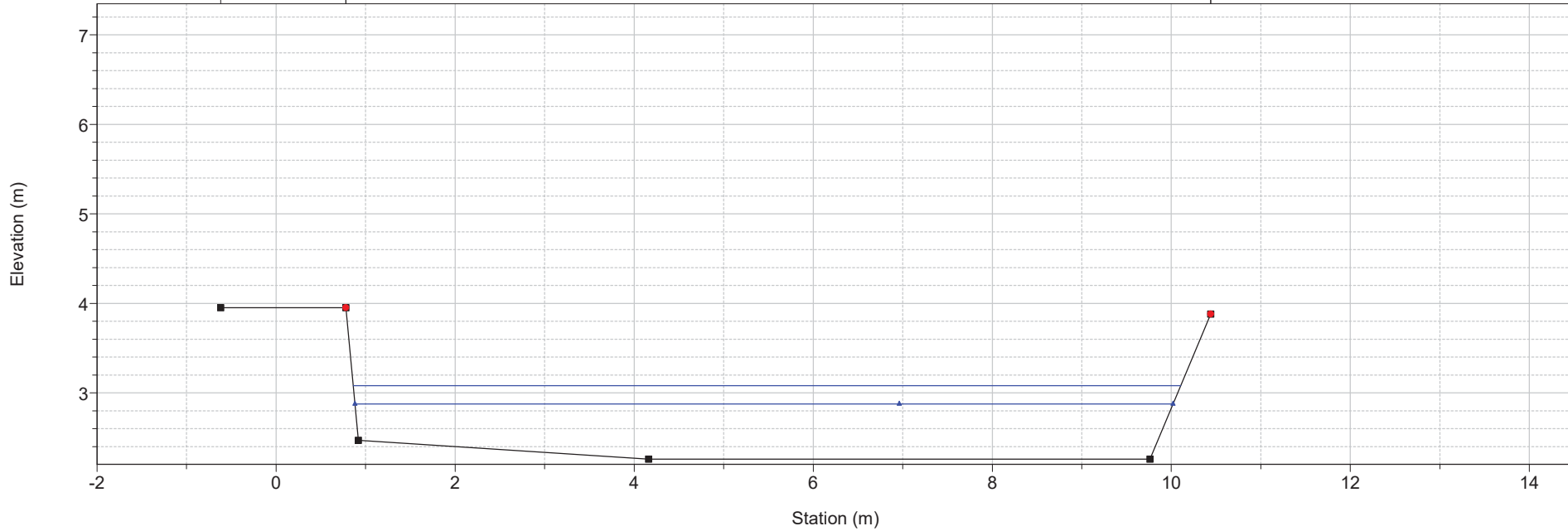

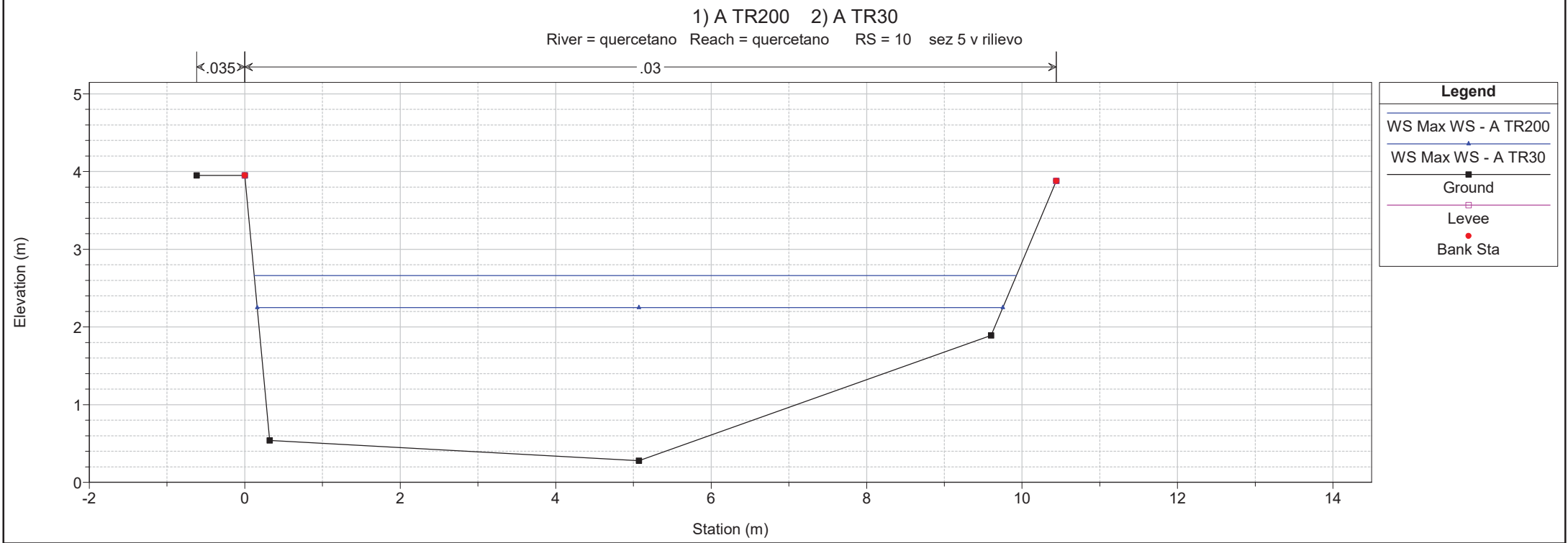
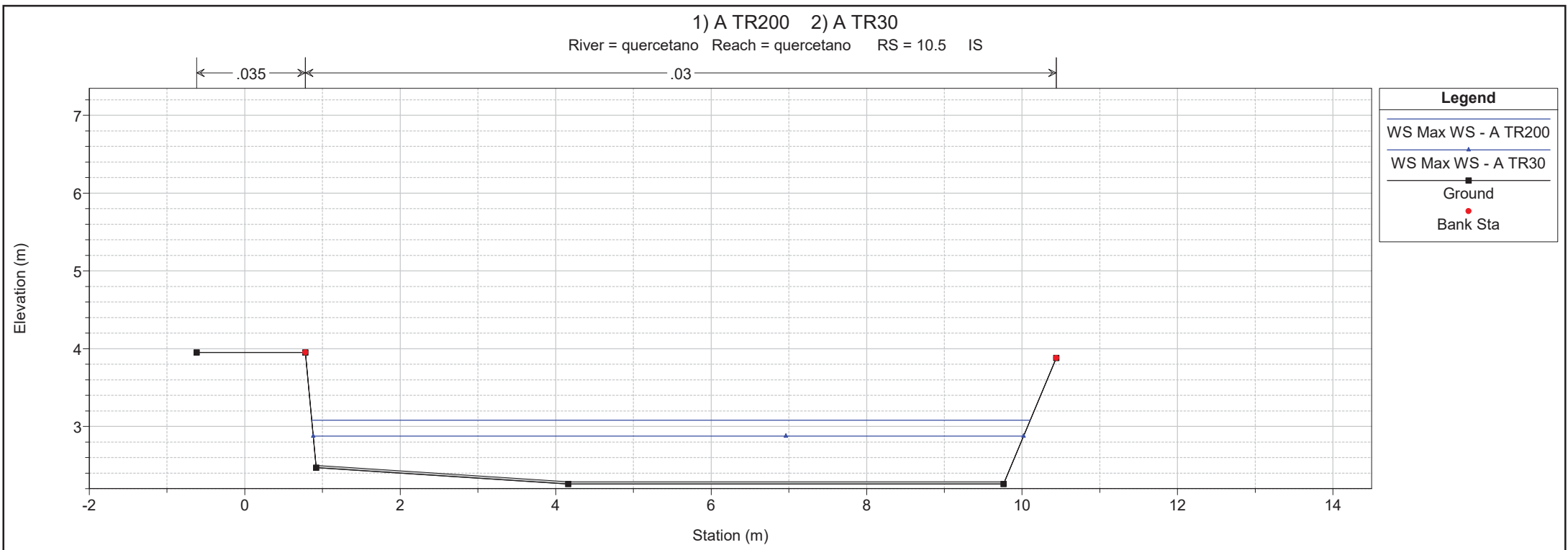

1 cm Horiz. = 0.7 m 1 cm Vert. = 0.7 m

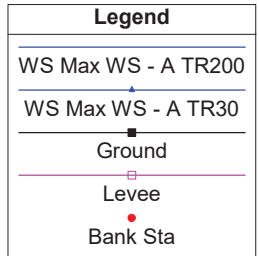
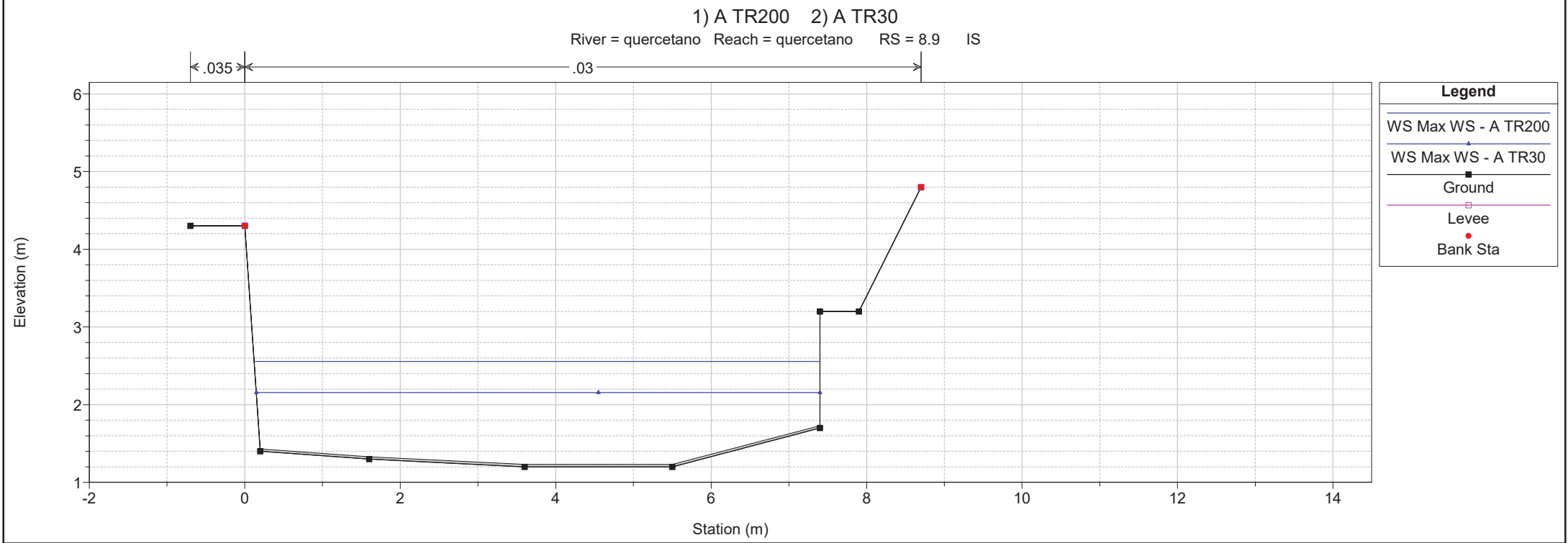
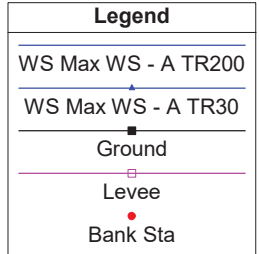
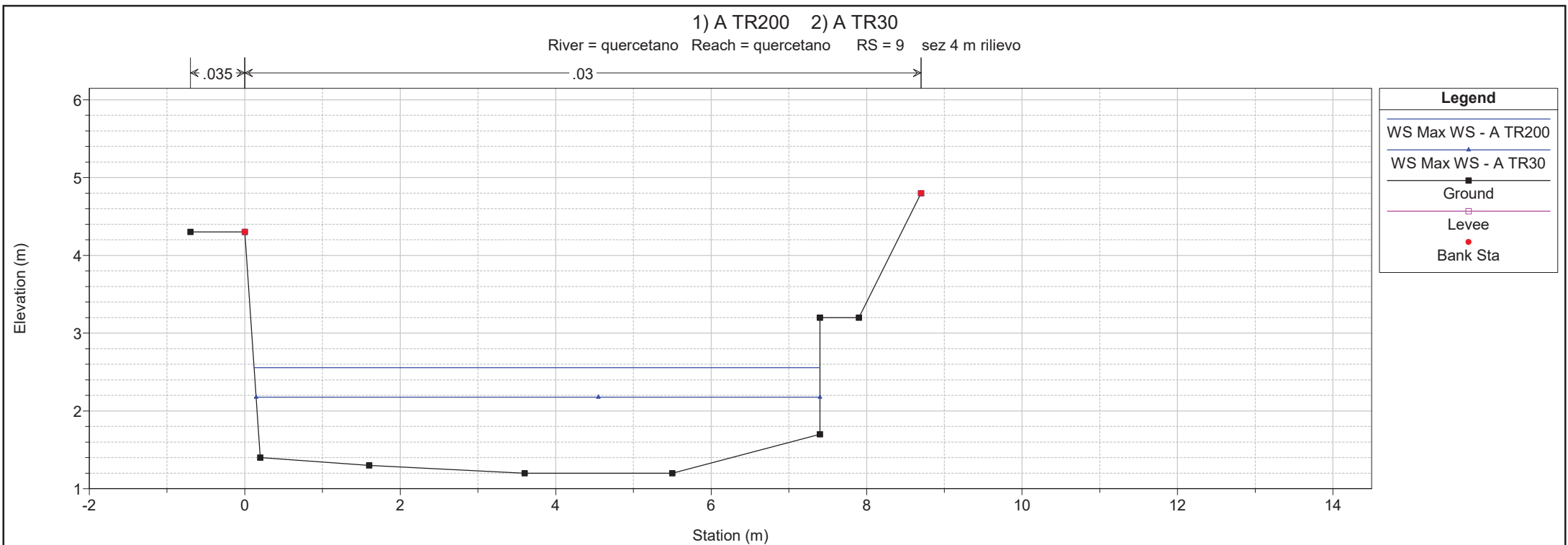

1 cm Horiz. = 0.7 m 1 cm Vert. = 0.7 m

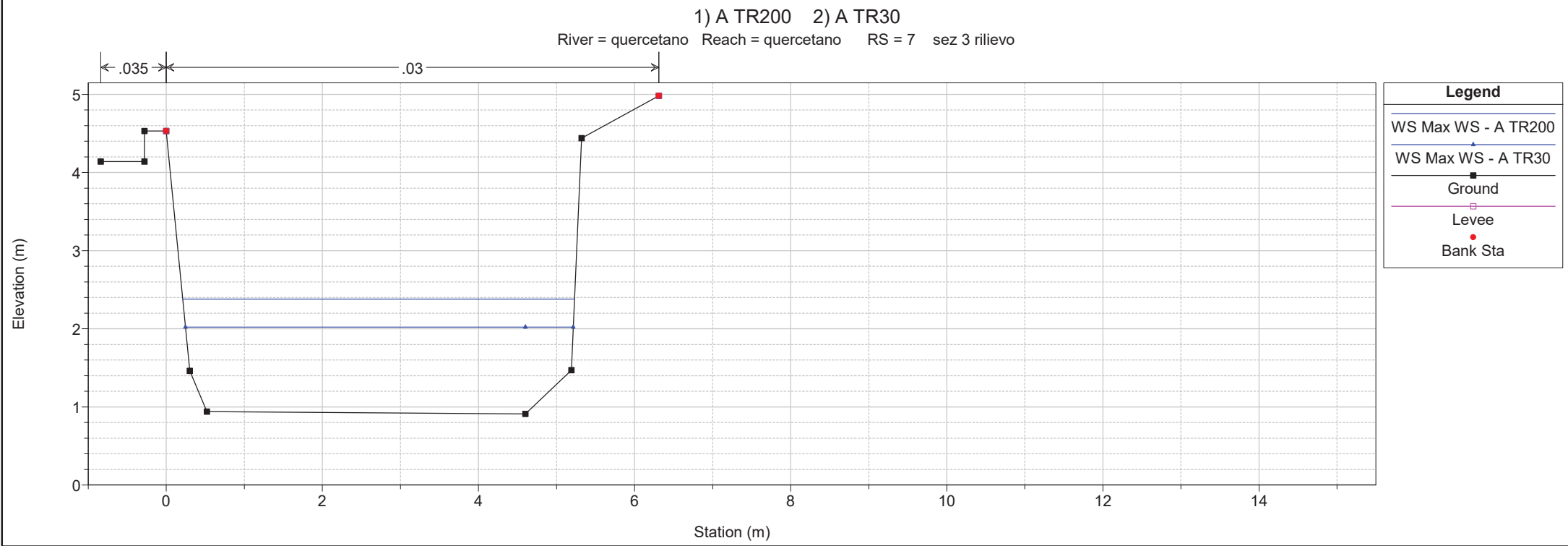
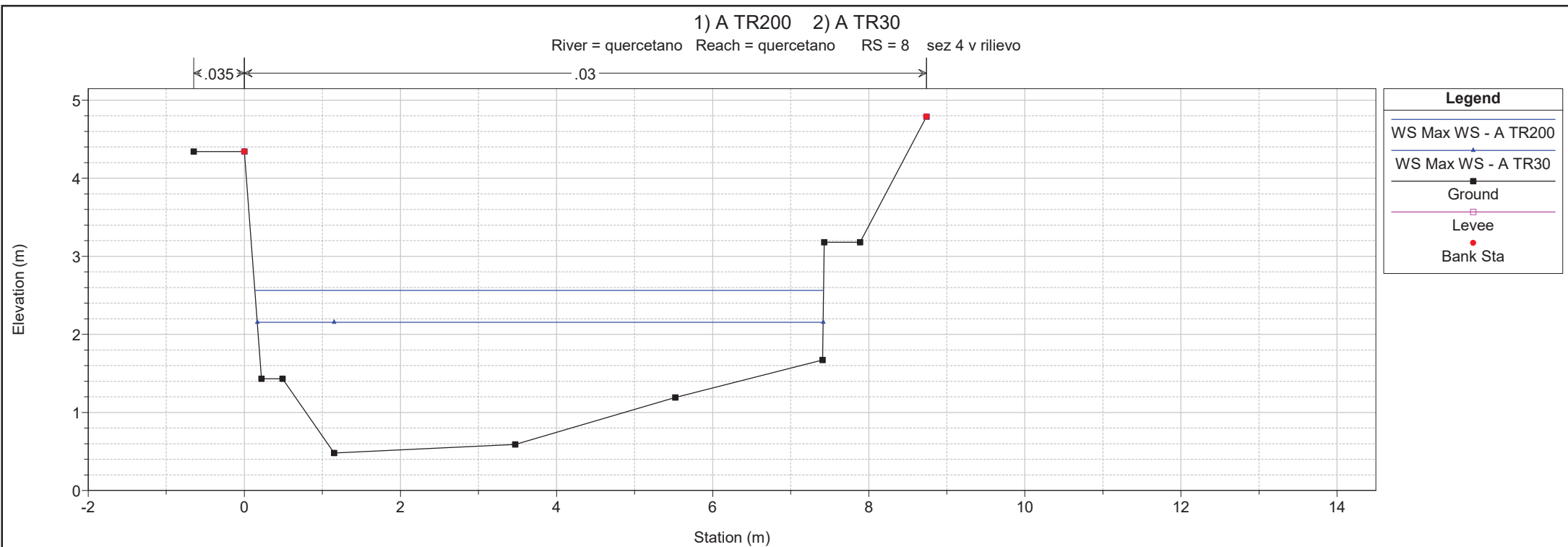

1 cm Horiz. = 0.7 m 1 cm Vert. = 0.7 m

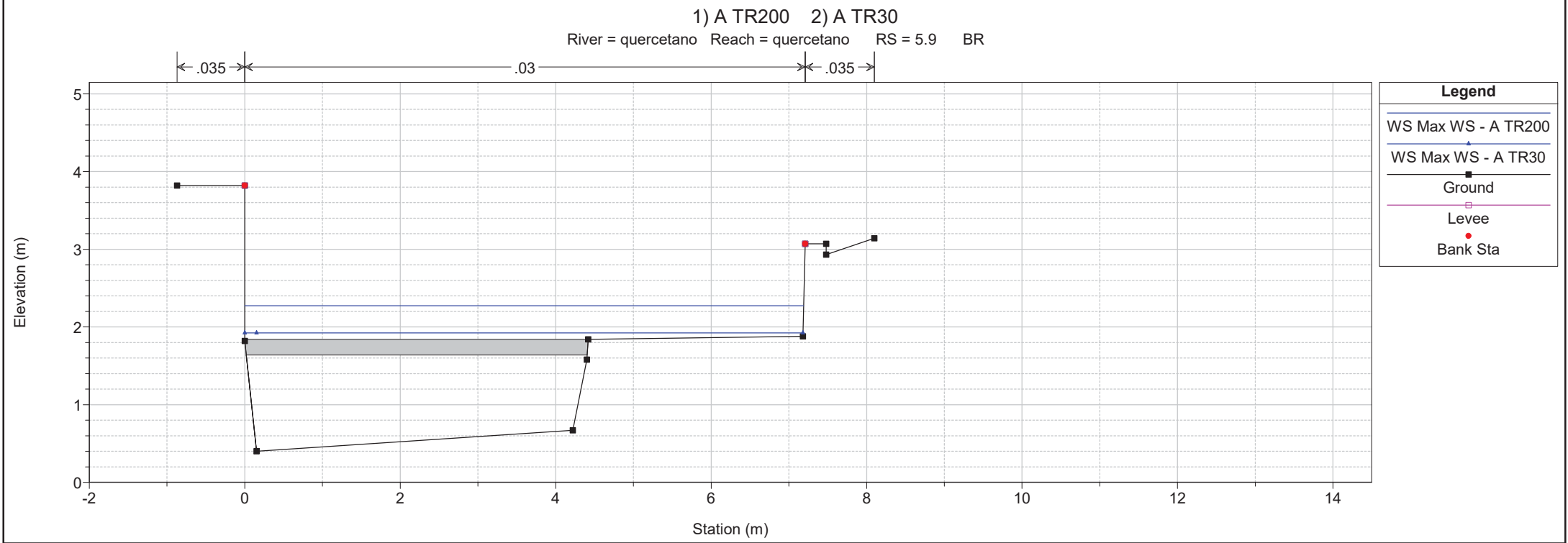
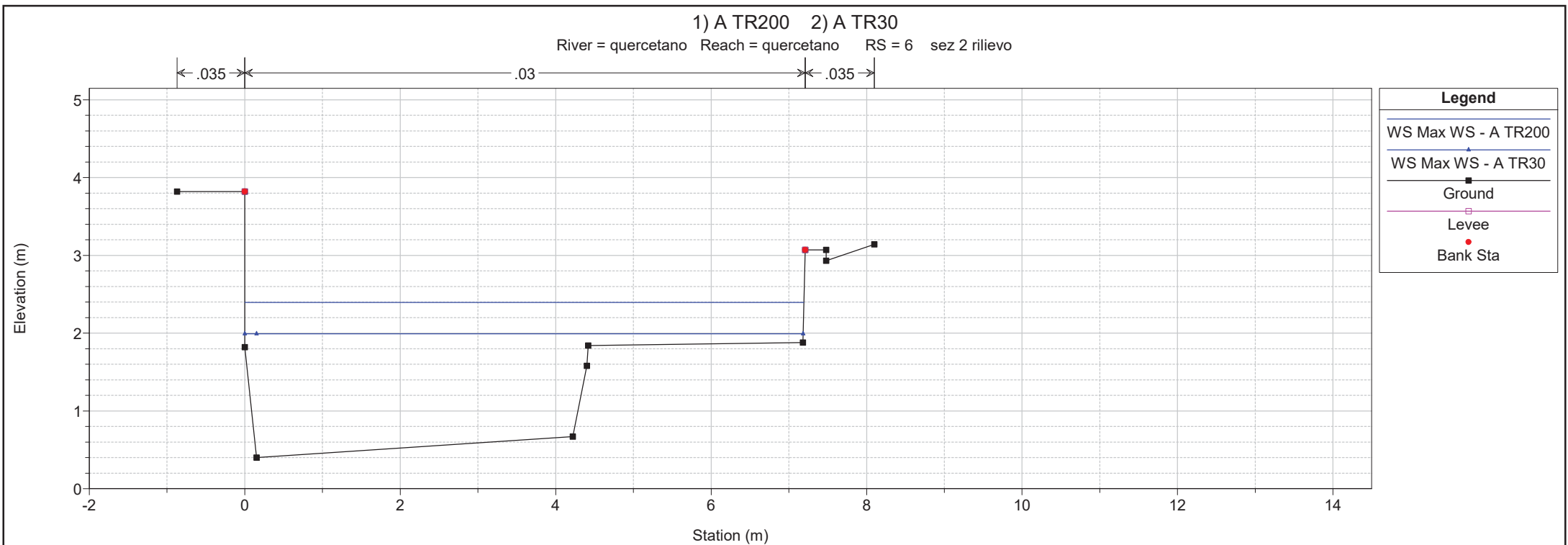

1 cm Horiz. = 0.7 m 1 cm Vert. = 0.7 m

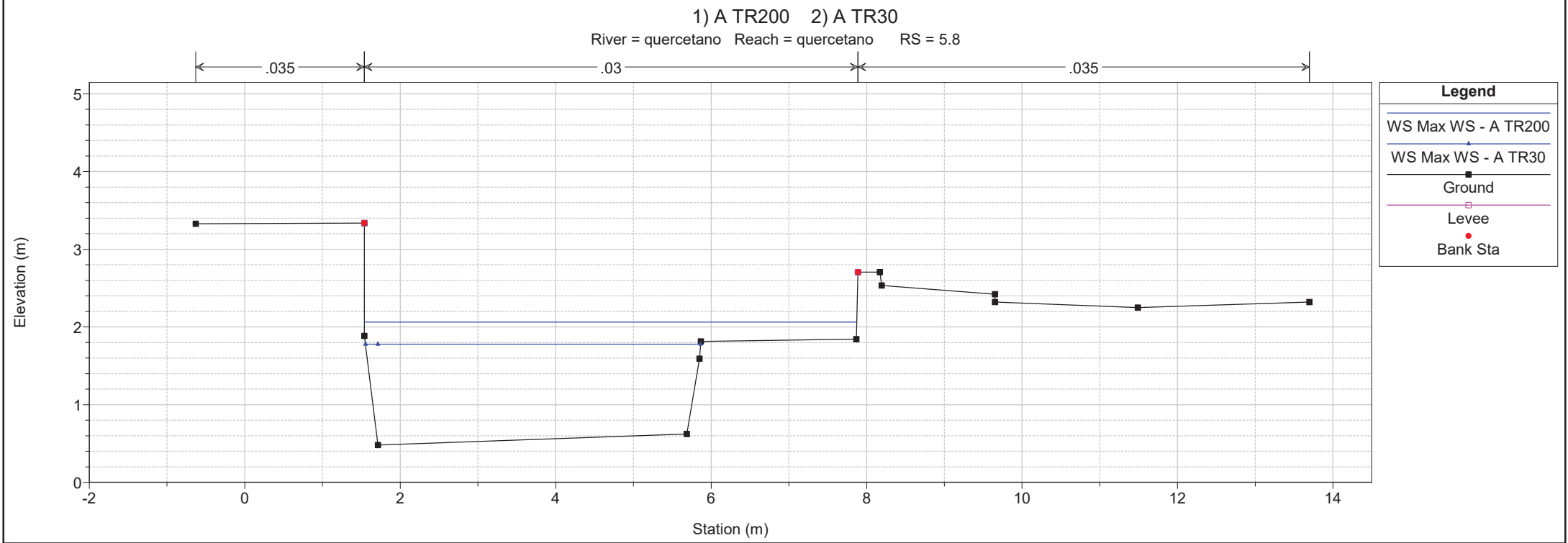
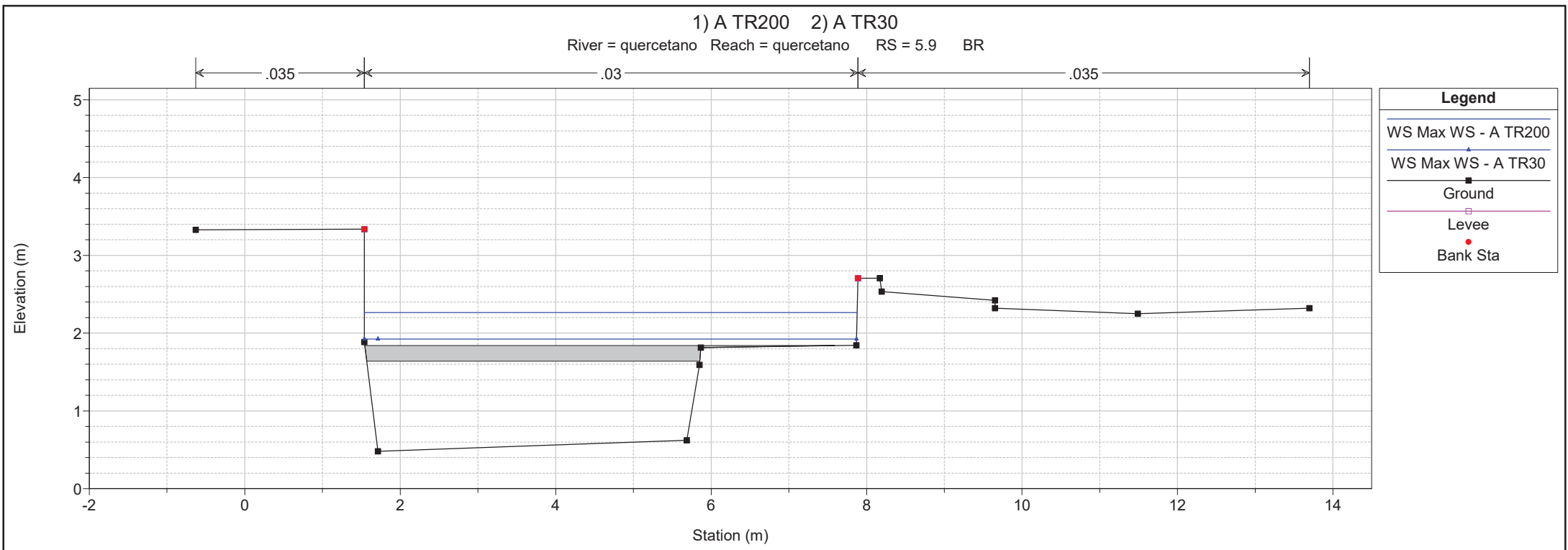

1 cm Horiz. = 0.7 m 1 cm Vert. = 0.7 m

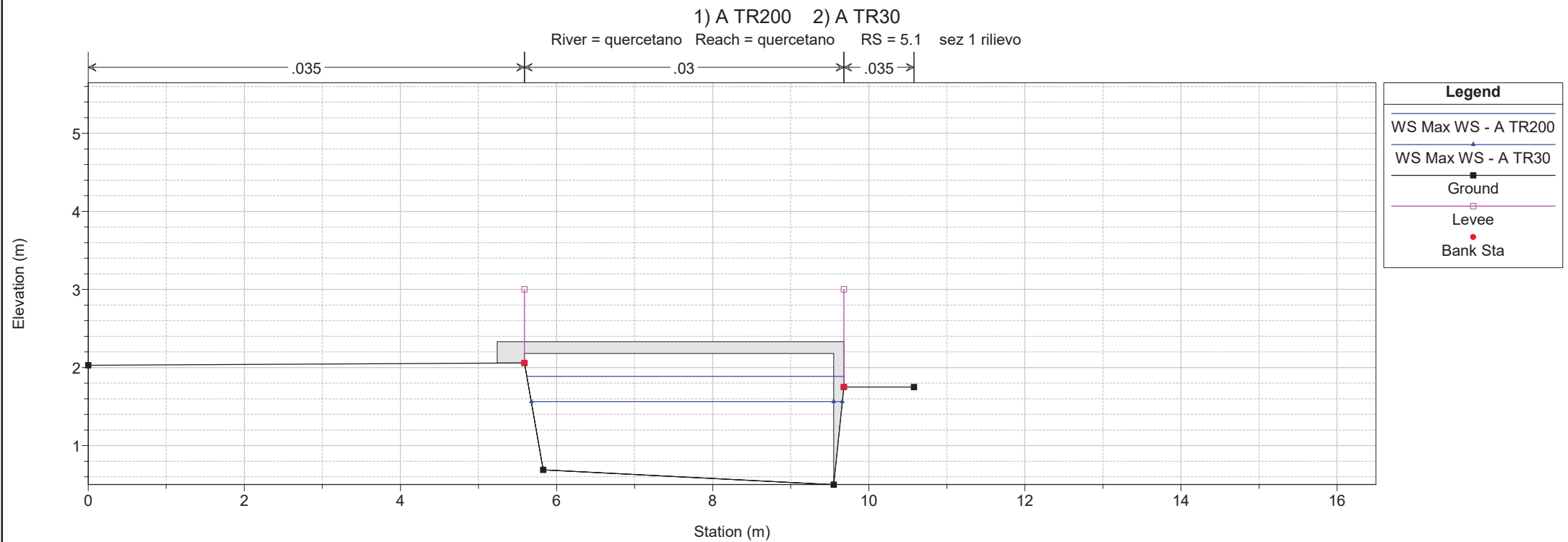
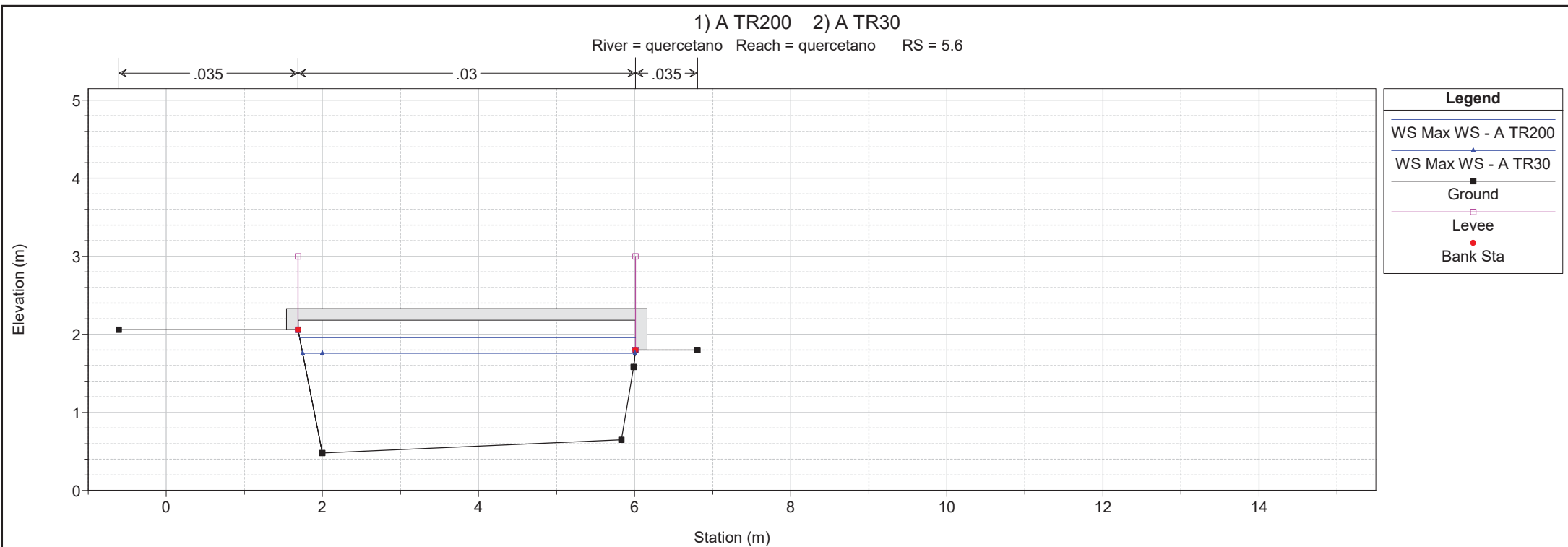

1 cm Horiz. = 0.7 m 1 cm Vert. = 0.7 m

1) A TR200 2) A TR30

River = quercetano Reach = quercetano RS = 5 sez 1 rilievo

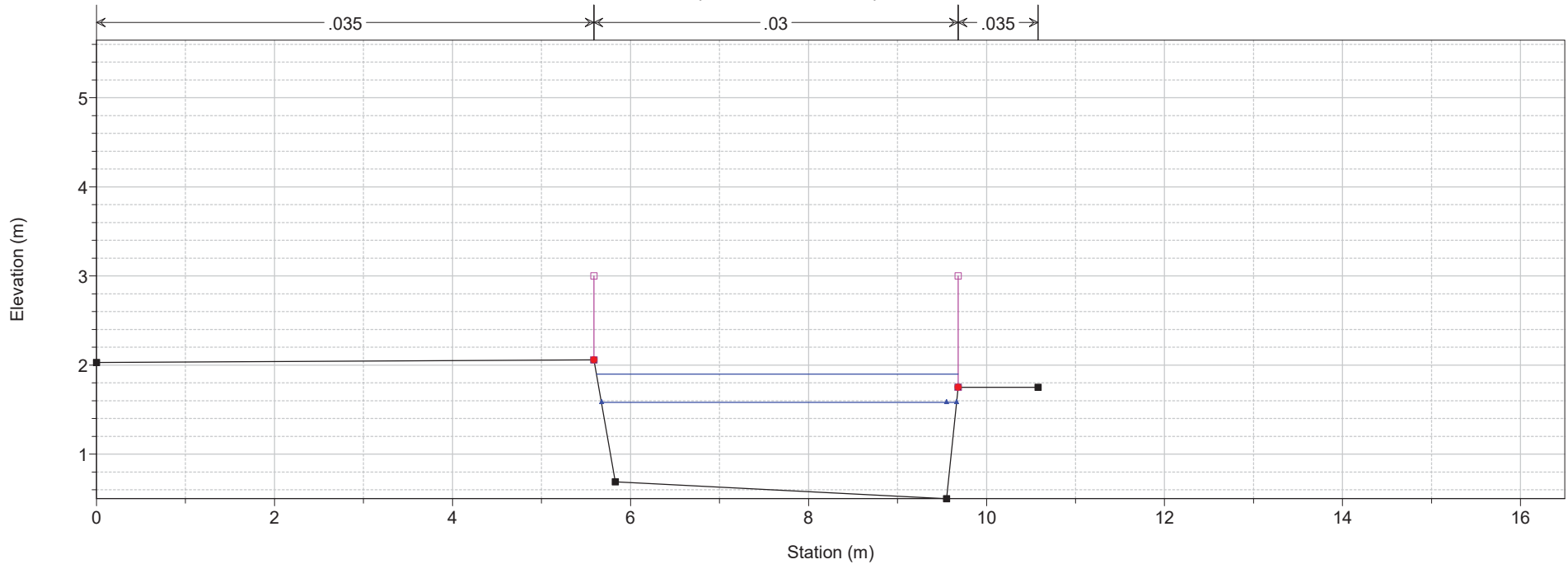

Legend

- WS Max WS - A TR200
- WS Max WS - A TR30
- Ground
- Levee
- Bank Sta

Reach	River Sta	Plan	Q Total (m3/s)	Min Ch El (m)	W.S. Elev (m)	Crit W.S. (m)	E.G. Elev (m)	E.G. Slope (m/m)	Vel Chnl (m/s)	Flow Area (m2)	Top Width (m)	Froude # Chl
quercetano	11	A TR200	15.15	2.26	3.08	2.96	3.31	0.006848	2.14	7.08	9.24	0.78
quercetano	11	A TR30	9.14	2.26	2.88	2.77	3.04	0.006523	1.75	5.22	9.14	0.74
quercetano	10.8	A TR200	15.15	2.26	3.08	2.96	3.31	0.006890	2.15	7.06	9.24	0.78
quercetano	10.8	A TR30	9.14	2.26	2.88	2.77	3.03	0.006578	1.76	5.20	9.14	0.74
quercetano	10.5		Inl Struct									
quercetano	10	A TR200	15.16	0.28	2.66	1.29	2.70	0.000383	0.84	18.15	9.80	0.20
quercetano	10	A TR30	9.14	0.28	2.25	1.05	2.27	0.000288	0.64	14.19	9.59	0.17
quercetano	9	A TR200	15.15	1.20	2.56	2.08	2.70	0.002633	1.68	9.03	7.28	0.48
quercetano	9	A TR30	9.02	1.20	2.18	1.85	2.28	0.002798	1.44	6.27	7.25	0.49
quercetano	8.9		Inl Struct									
quercetano	8	A TR200	15.15	0.48	2.56	1.71	2.65	0.001201	1.29	11.70	7.29	0.33
quercetano	8	A TR30	9.23	0.48	2.15	1.46	2.21	0.001057	1.06	8.73	7.25	0.31
quercetano	7	A TR200	15.15	0.91	2.38	1.96	2.62	0.004555	2.18	6.95	5.02	0.59
quercetano	7	A TR30	9.19	0.91	2.02	1.68	2.18	0.003925	1.78	5.17	4.97	0.56
quercetano	6	A TR200	15.15	0.40	2.39	1.64	2.52	0.002656	1.60	9.47	7.19	0.44
quercetano	6	A TR30	9.16	0.40	1.99	1.33	2.09	0.002940	1.39	6.58	7.18	0.46
quercetano	5.9		Bridge									
quercetano	5.8	A TR200	15.15	0.48	2.06	1.68	2.32	0.006522	2.23	6.79	6.33	0.69
quercetano	5.8	A TR30	9.16	0.48	1.78	1.36	1.94	0.004005	1.80	5.09	4.31	0.53
quercetano	5.6	A TR200	15.15	0.48	1.96	1.71	2.32	0.007583	2.66	5.70	4.30	0.74
quercetano	5.6	A TR30	9.16	0.48	1.76	1.39	1.94	0.004550	1.89	4.84	4.26	0.57
quercetano	5.59		Lat Struct									
quercetano	5.58		Lat Struct									
quercetano	5.1	A TR200	13.84	0.50	1.89	1.71	2.28	0.007019	2.79	5.06	4.83	0.75
quercetano	5.1	A TR30	9.15	0.50	1.56	1.44	1.88	0.007582	2.49	3.67	3.87	0.77
quercetano	5	A TR200	13.84	0.50	1.90	1.70	2.28	0.009001	2.72	5.08	4.06	0.78
quercetano	5	A TR30	9.15	0.50	1.58	1.44	1.88	0.009013	2.41	3.80	3.99	0.79

Reach	River Sta	Plan	Q US (m3/s)	Q Leaving Total (m3/s)	Q DS (m3/s)	Q Weir (m3/s)	Q Gates (m3/s)	Wr Top Width (m)	Weir Max Depth (m)	Weir Avg Depth (m)	Min El Weir Flow (m)	E.G. US. (m)	W.S. US. (m)	E.G. DS (m)	W.S. DS (m)
quercetano	5.59	A TR200	15.15	1.28	13.84	1.28		13.00	0.16	0.15	1.75	2.32	1.96	2.28	1.89
quercetano	5.59	A TR30	9.16	0.00	9.15	0.00					1.75	1.94	1.76	1.88	1.57
quercetano	5.58	A TR200	15.15	0.00	13.84	0.00					2.05	2.32	1.96	2.28	1.89
quercetano	5.58	A TR30	9.16	0.00	9.15	0.00					2.05	1.94	1.76	1.88	1.57

Botro delle Acacie

Stato attuale

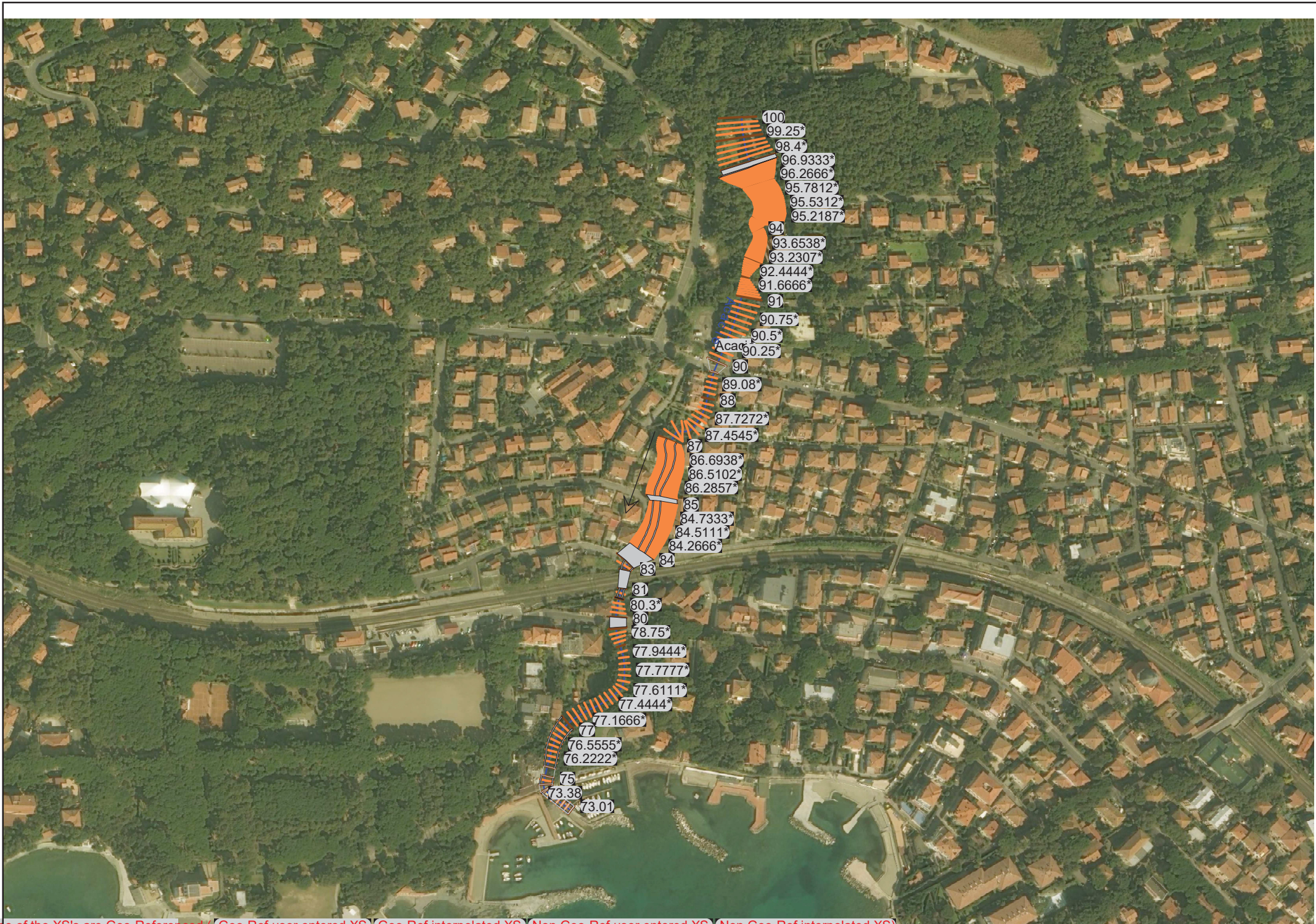

Note of the XS's are Geo-Referenced (Geo-Ref user entered XS, Geo-Ref interpolated XS, Non Geo-Ref user entered XS, Non Geo-Ref interpolated XS)

1 cm Horiz. = 39 m 1 cm Vert. = 32 m

1) A TR 200 2) A TR 30

Acacie Acacie

N.B. in grigio sono indicati gli sfioratori laterali in destra idrografica

Legend

- WS Max WS - A TR 200
- WS Max WS - A TR 30
- Ground

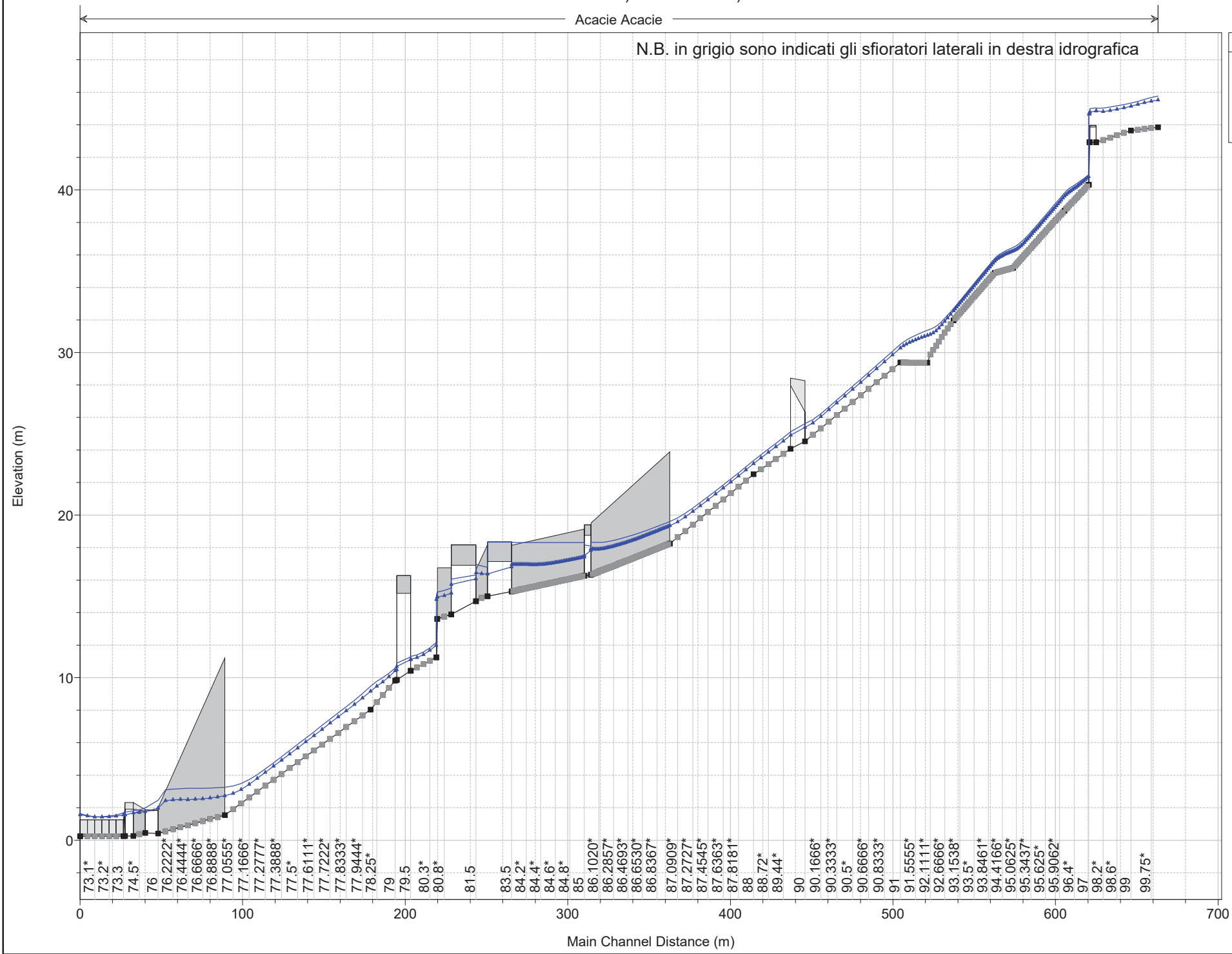

1 cm Horiz. = 30 m 1 cm Vert. = 3 m

1) A TR 200 2) A TR 30

Acacie Acacie

N.B. in grigio sono indicati gli sfioratori laterali in sinistra idrografica

Legend

- WS Max WS - A TR 200
- WS Max WS - A TR 30
- Ground

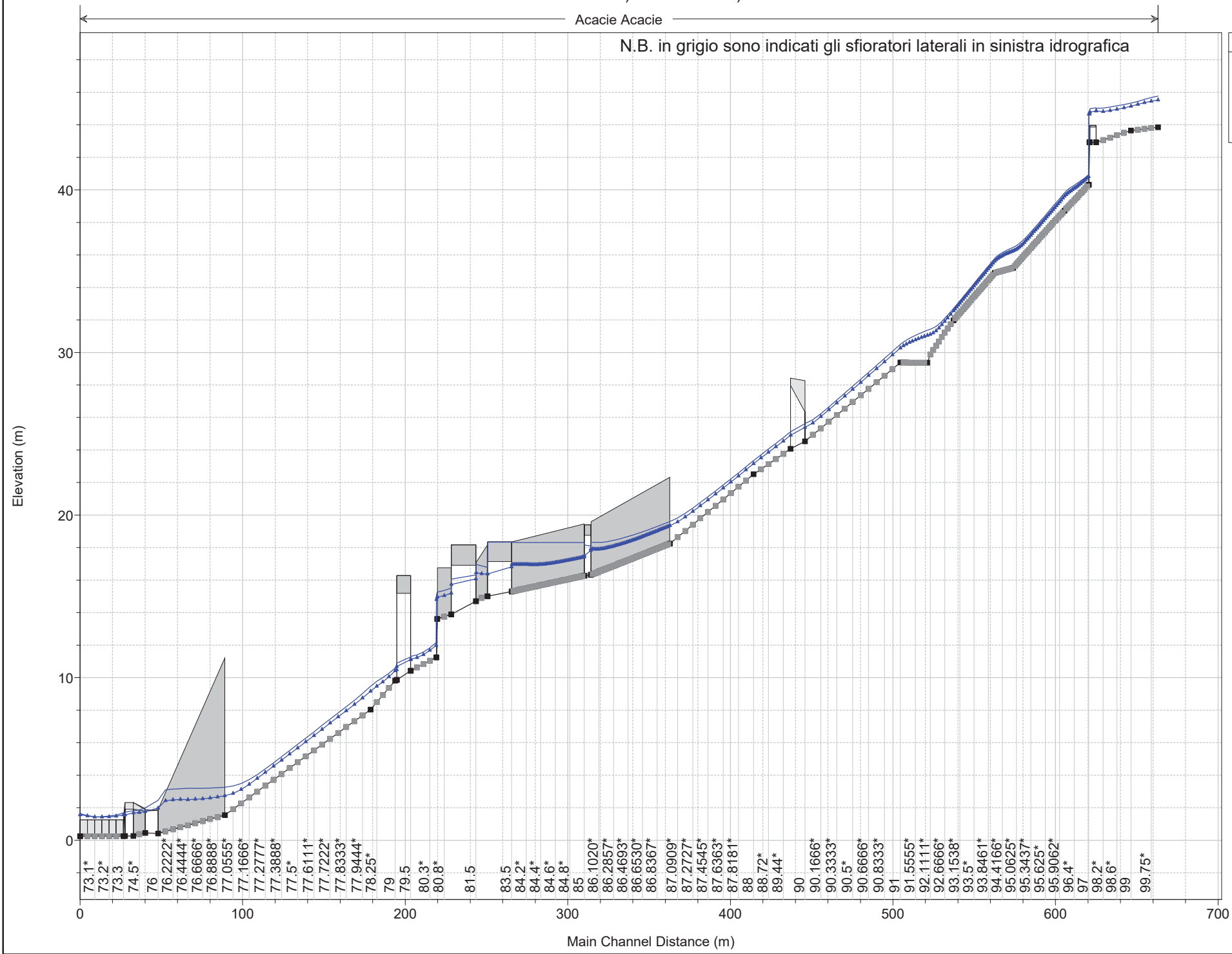

1 cm Horiz. = 30 m 1 cm Vert. = 3 m

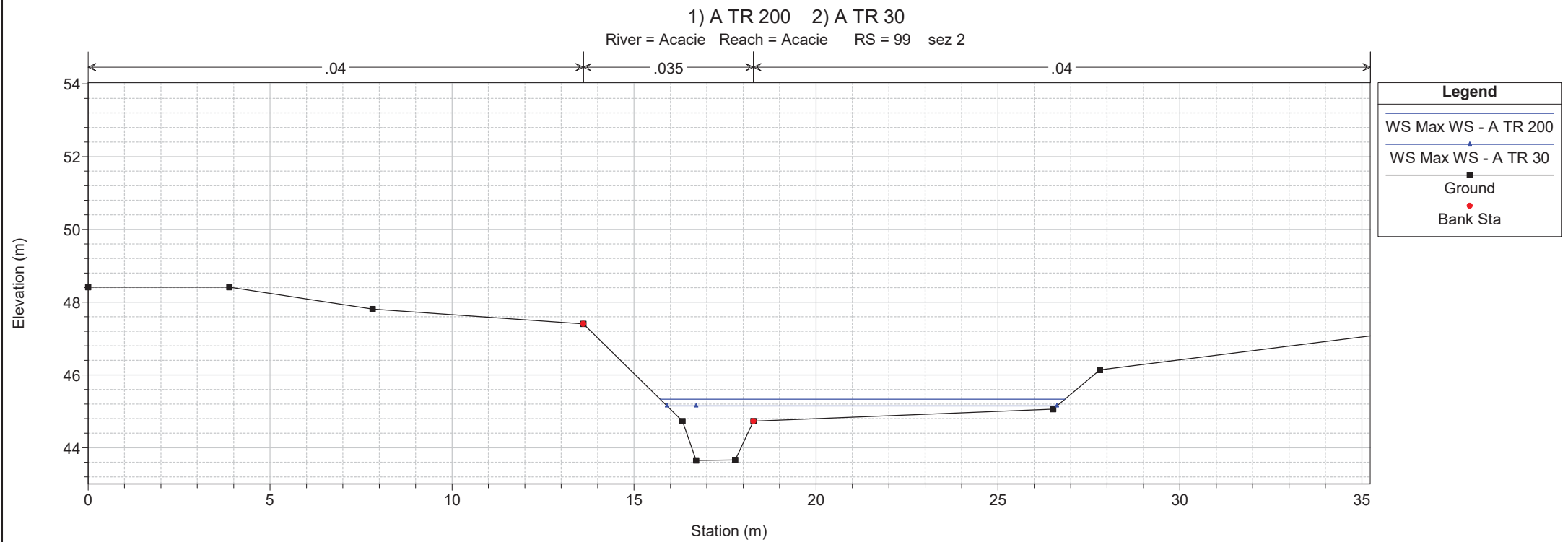
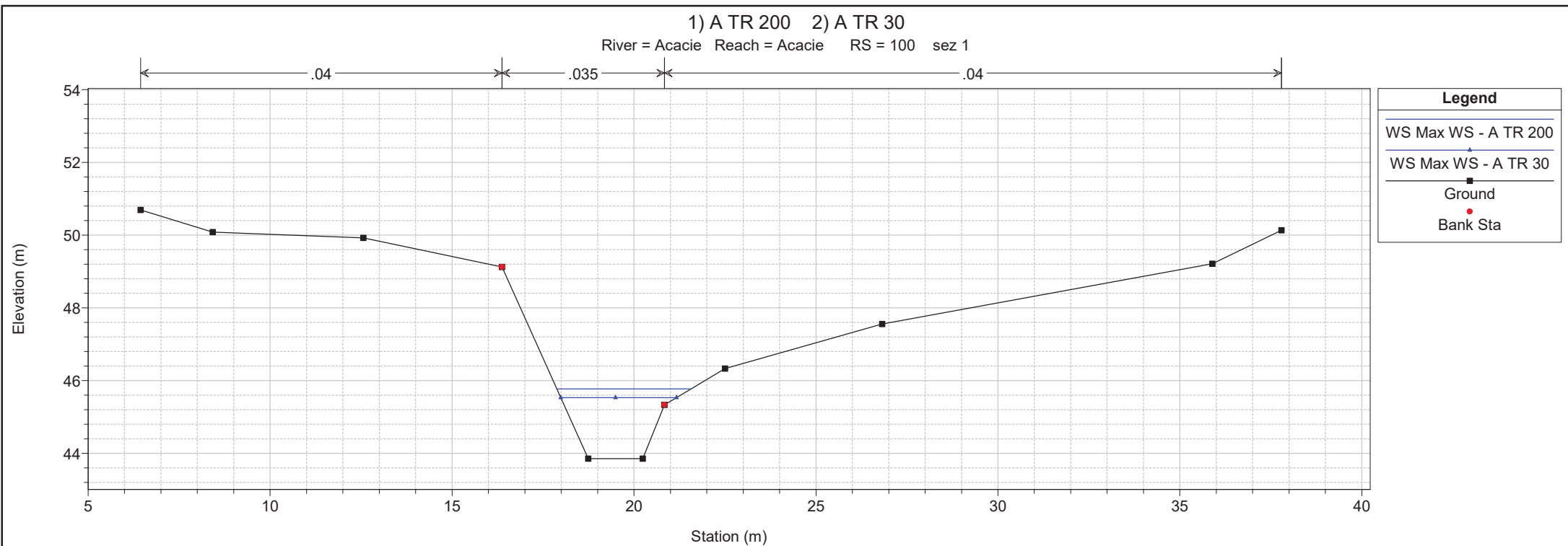

1 cm Horiz. = 1.5 m 1 cm Vert. = 1.5 m

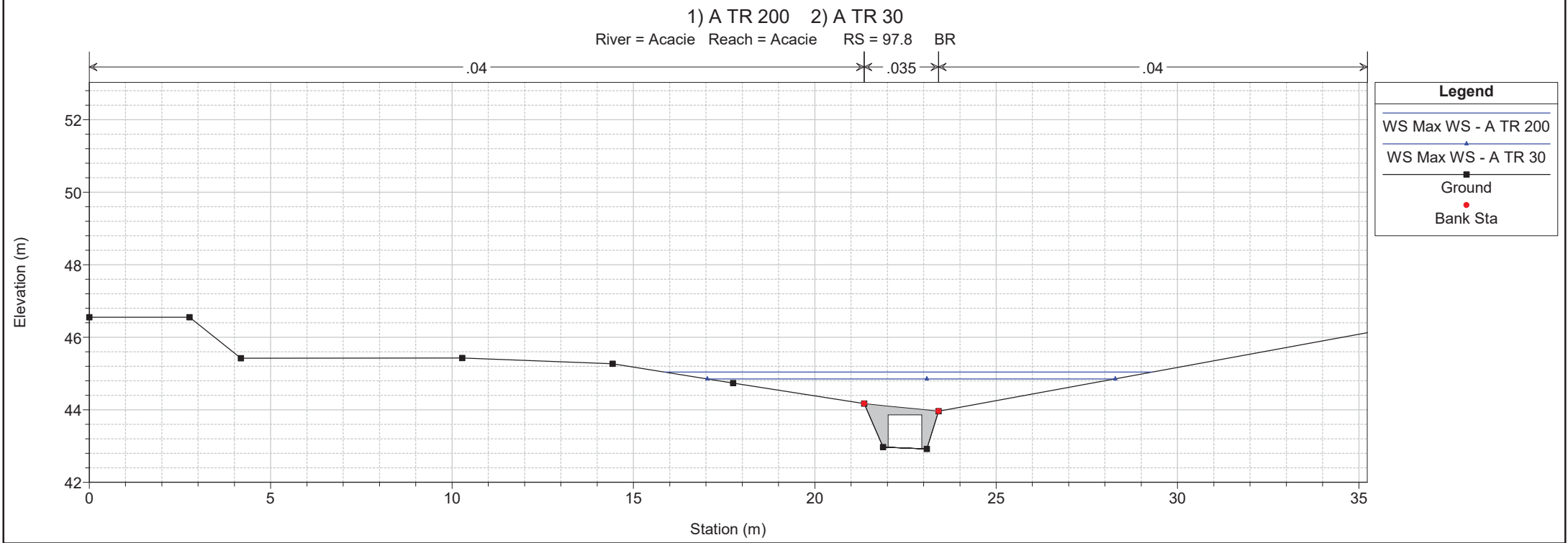
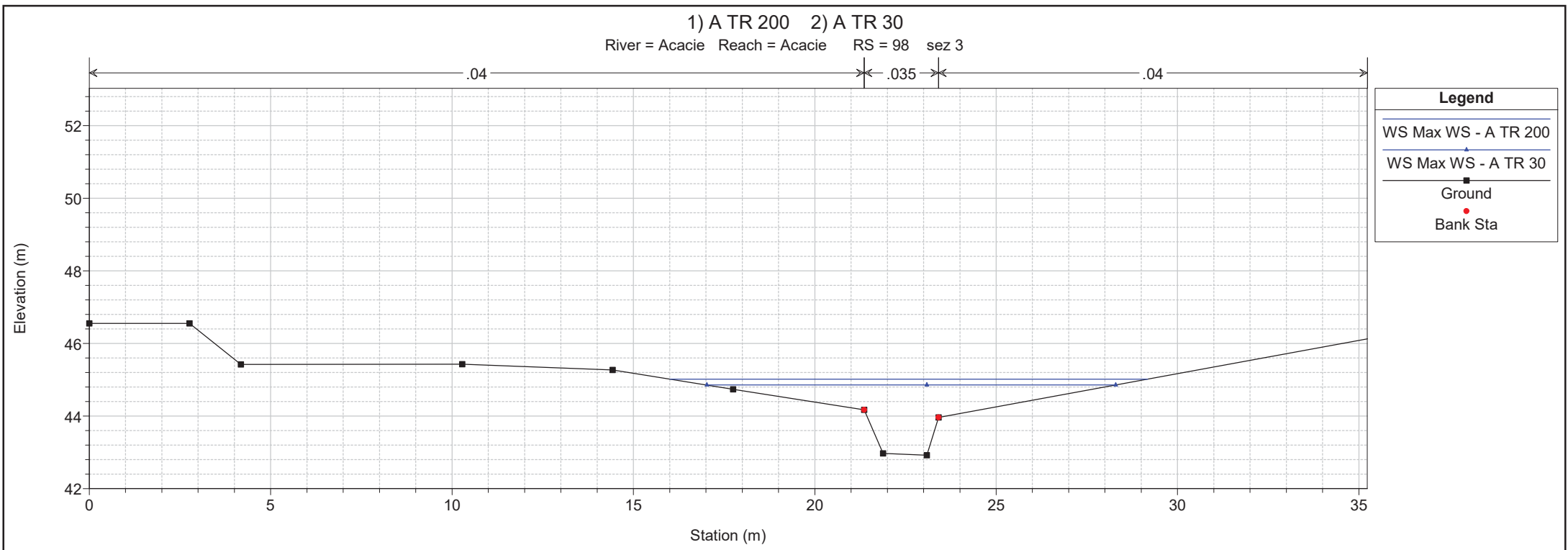

1 cm Horiz. = 1.5 m 1 cm Vert. = 1.5 m

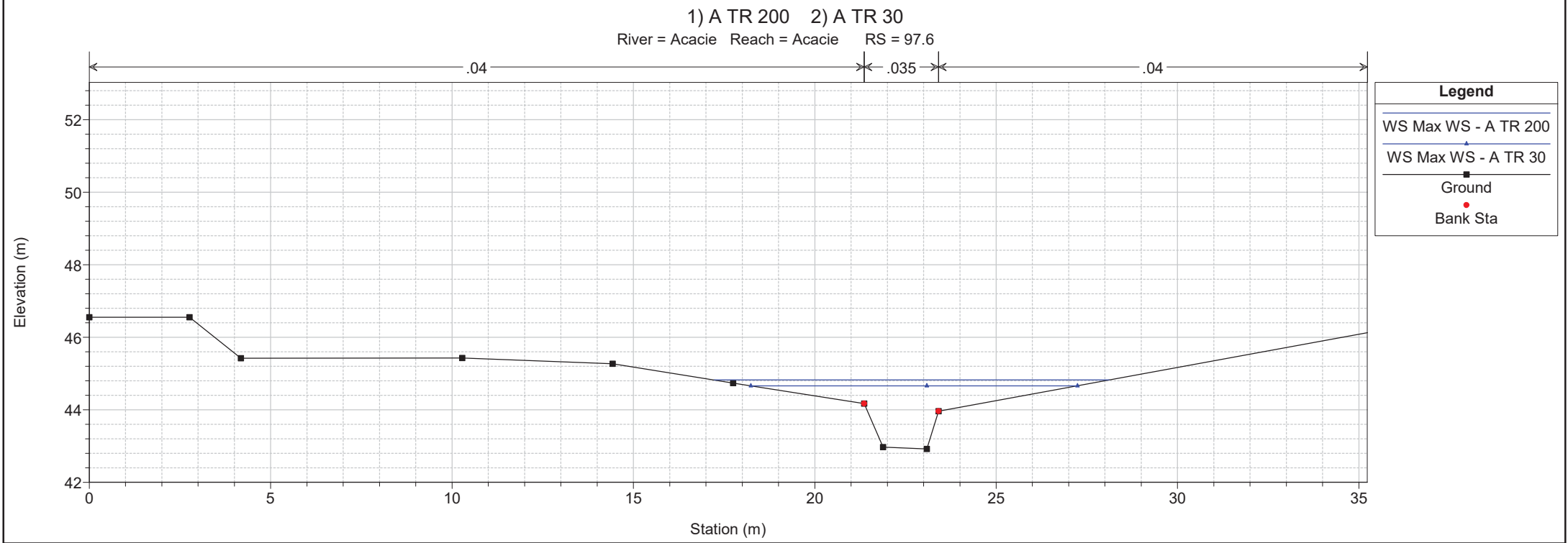
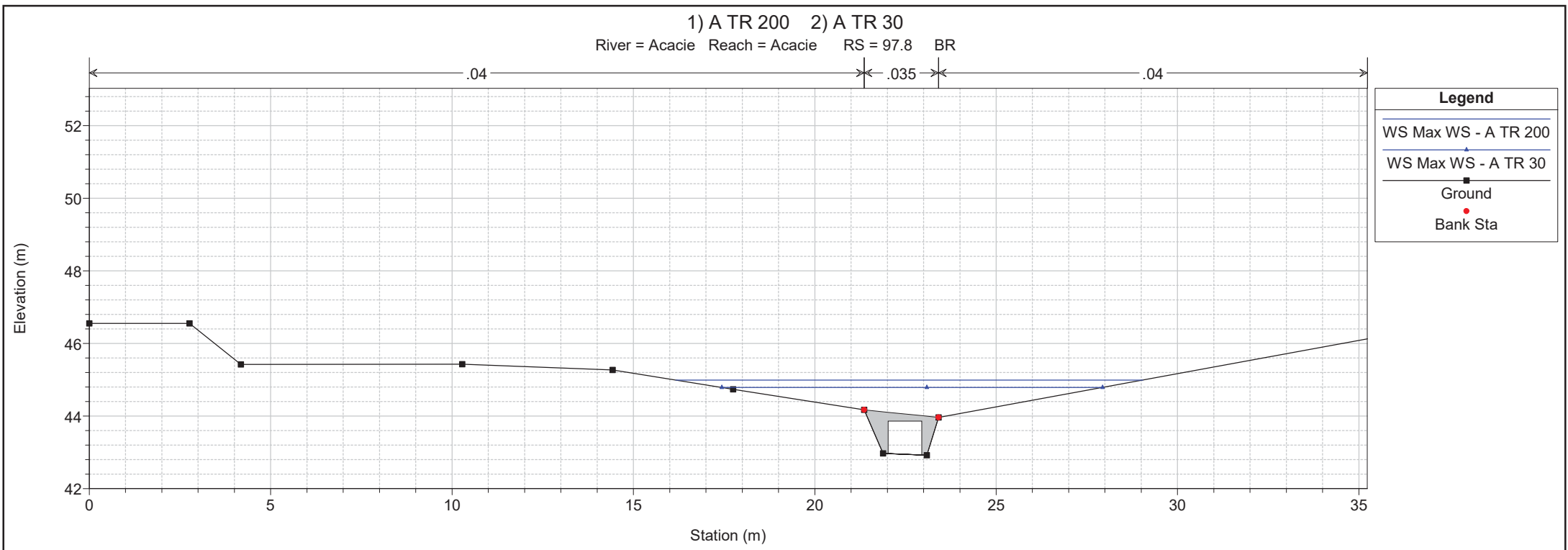

1 cm Horiz. = 1.5 m 1 cm Vert. = 1.5 m

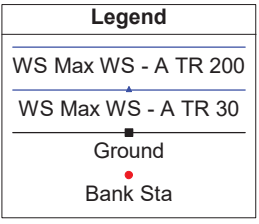
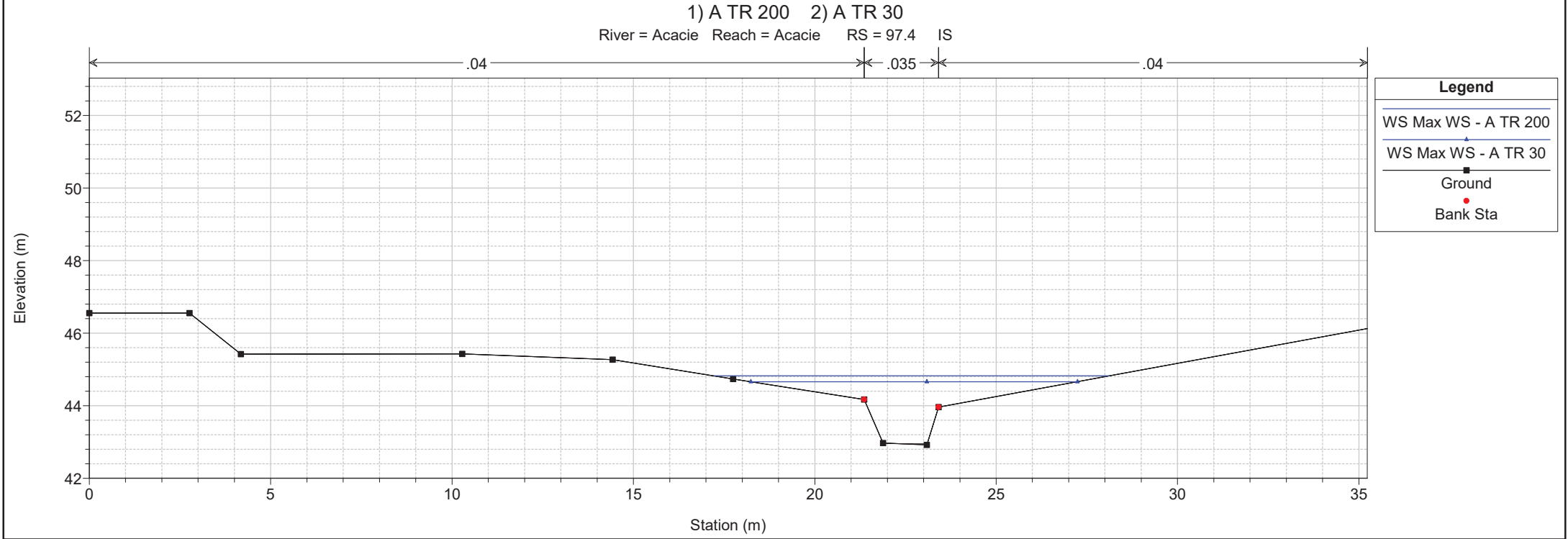
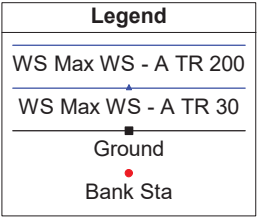
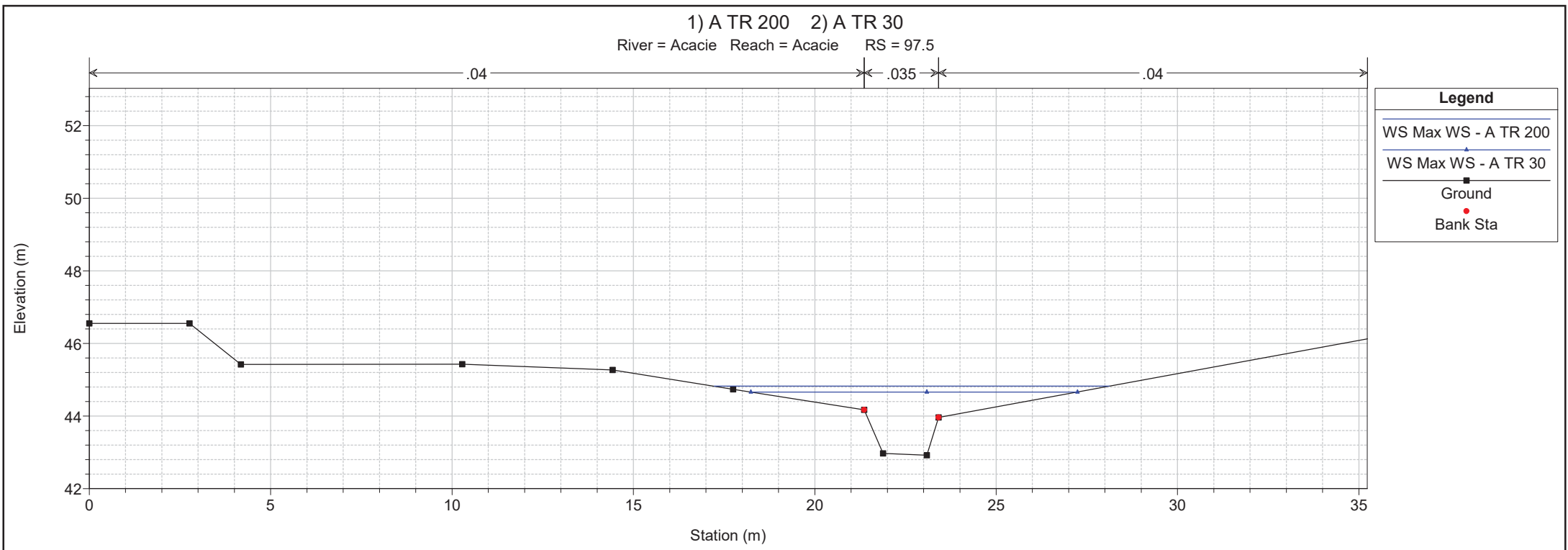

1 cm Horiz. = 1.5 m 1 cm Vert. = 1.5 m

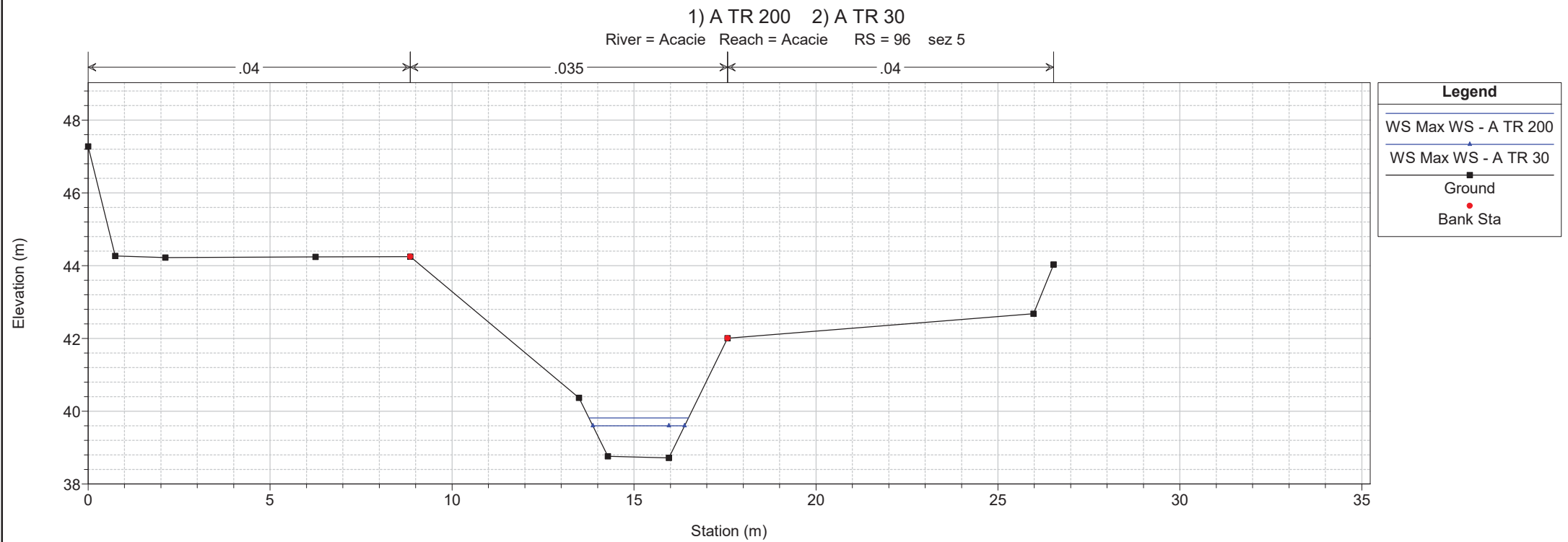
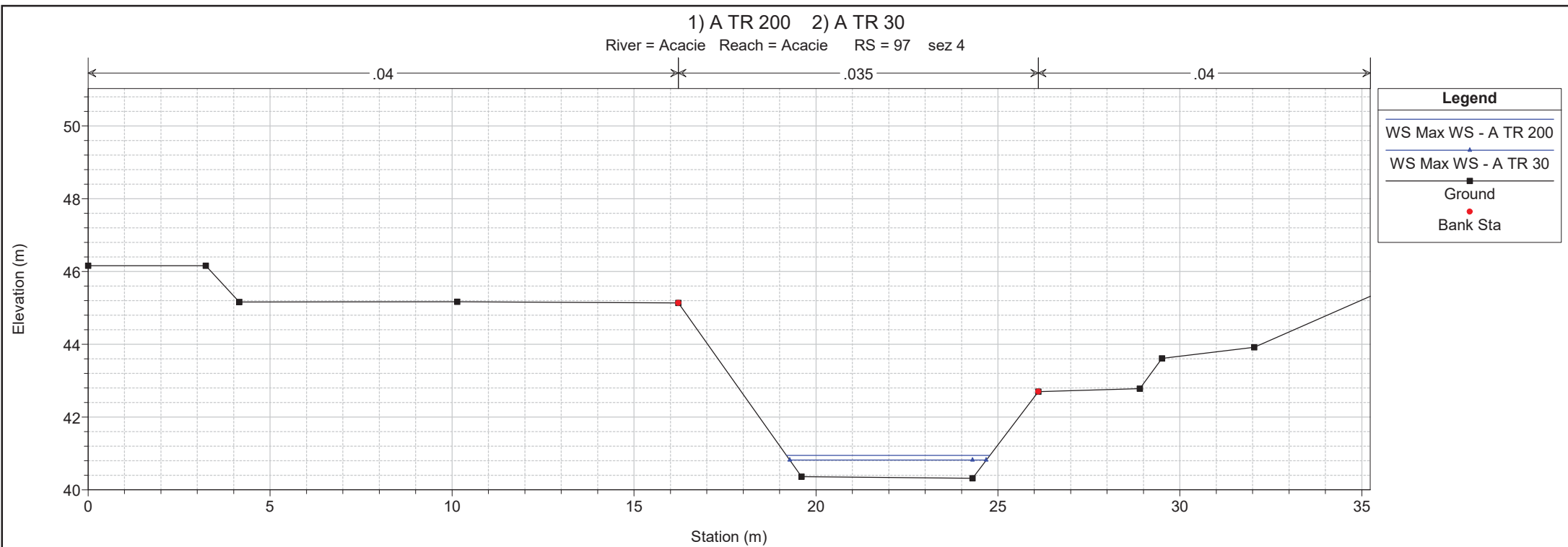

1) A TR 200 2) A TR 30
 River = Acacie Reach = Acacie RS = 95 sez 6

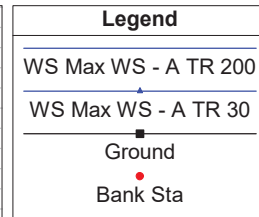
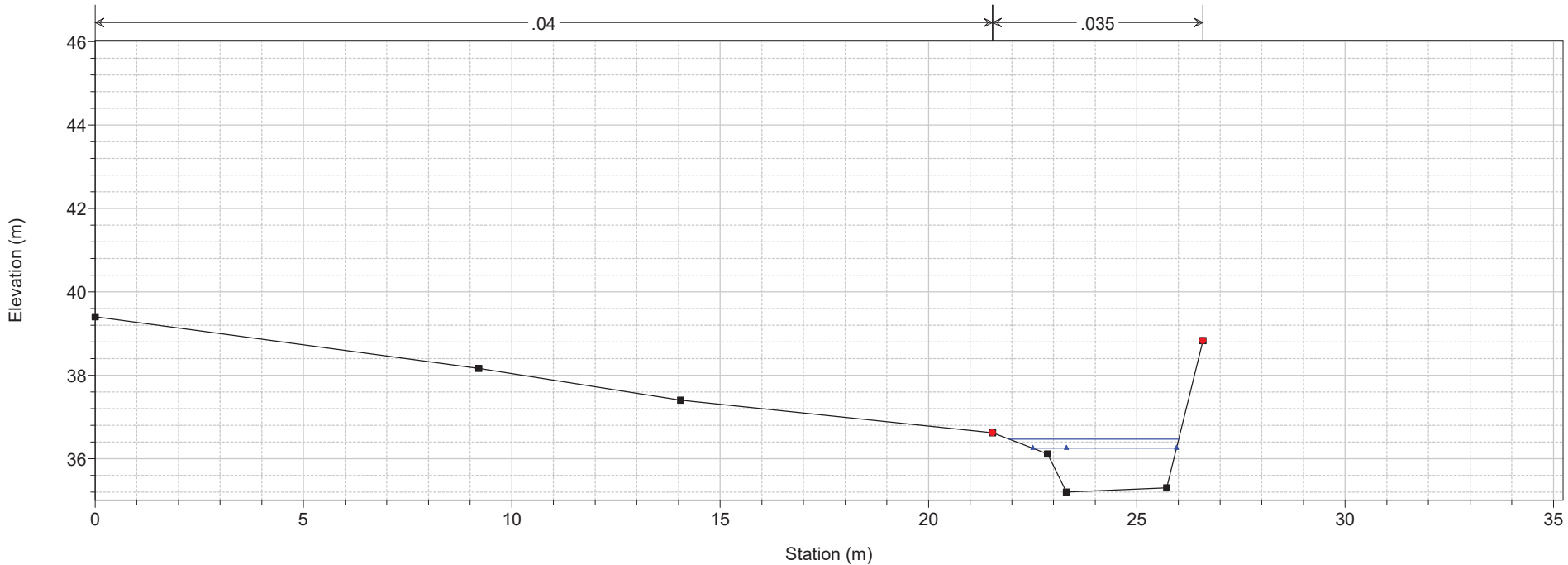

1) A TR 200 2) A TR 30
 River = Acacie Reach = Acacie RS = 94 sez 7

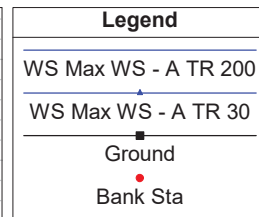
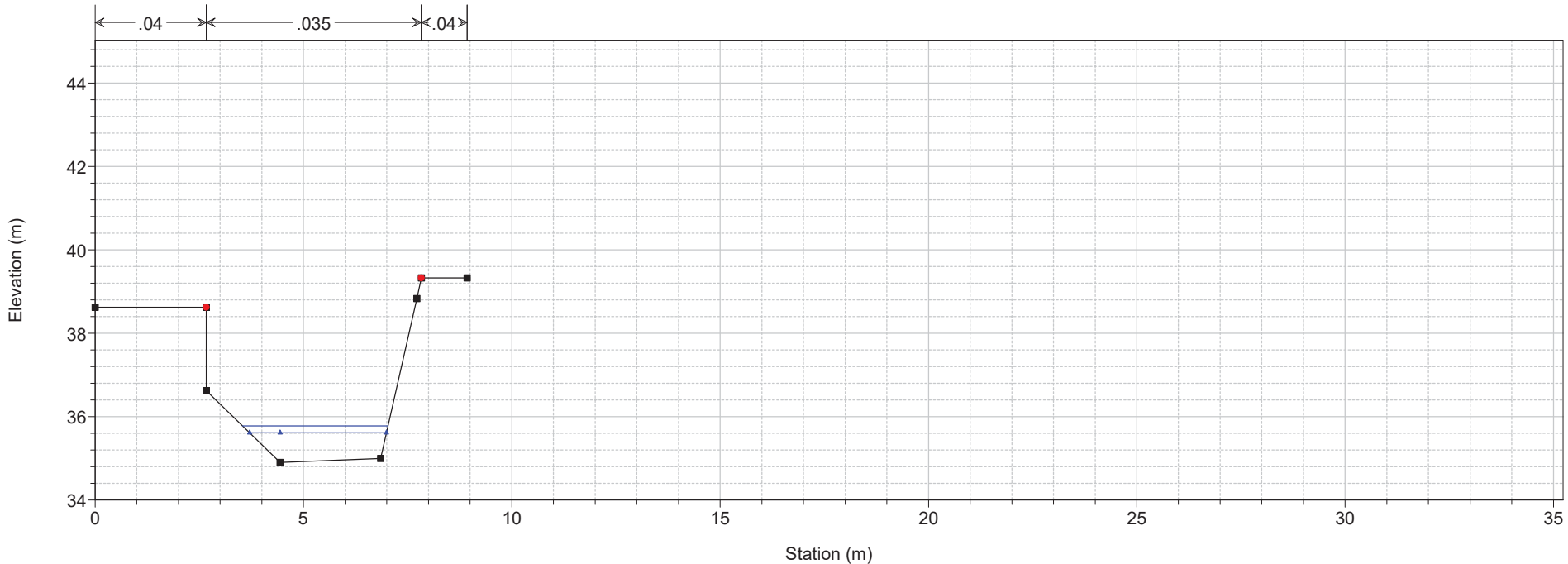

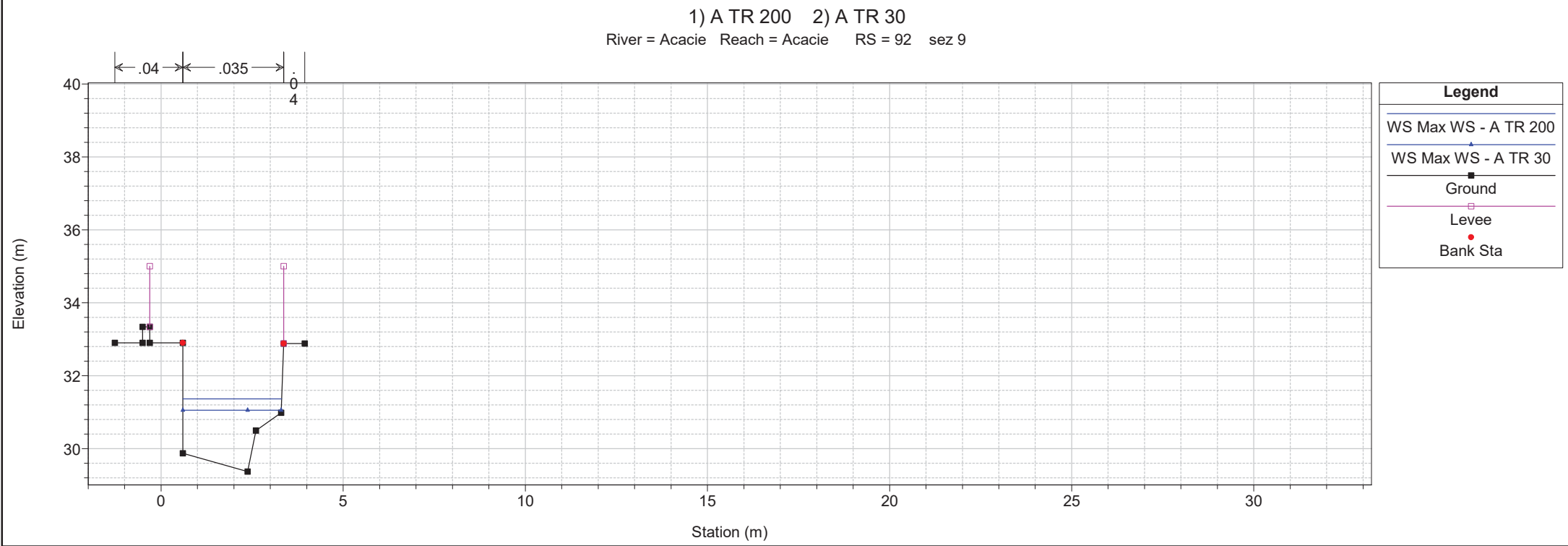
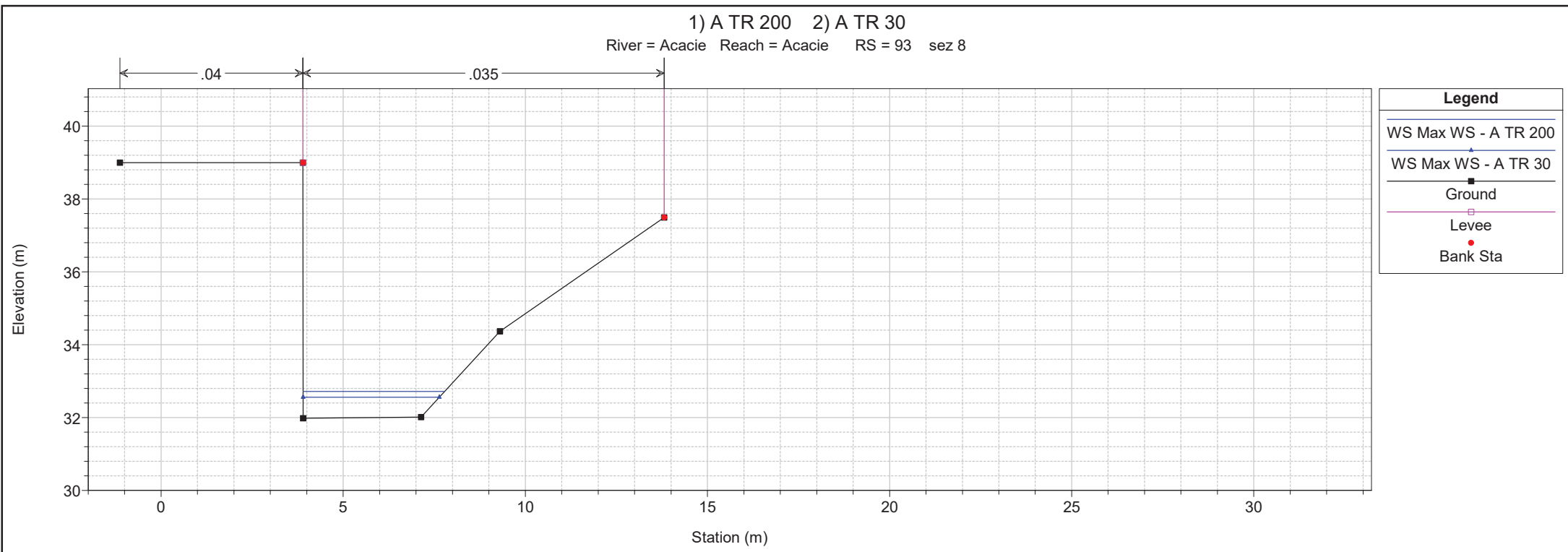

1 cm Horiz. = 1.5 m 1 cm Vert. = 1.5 m

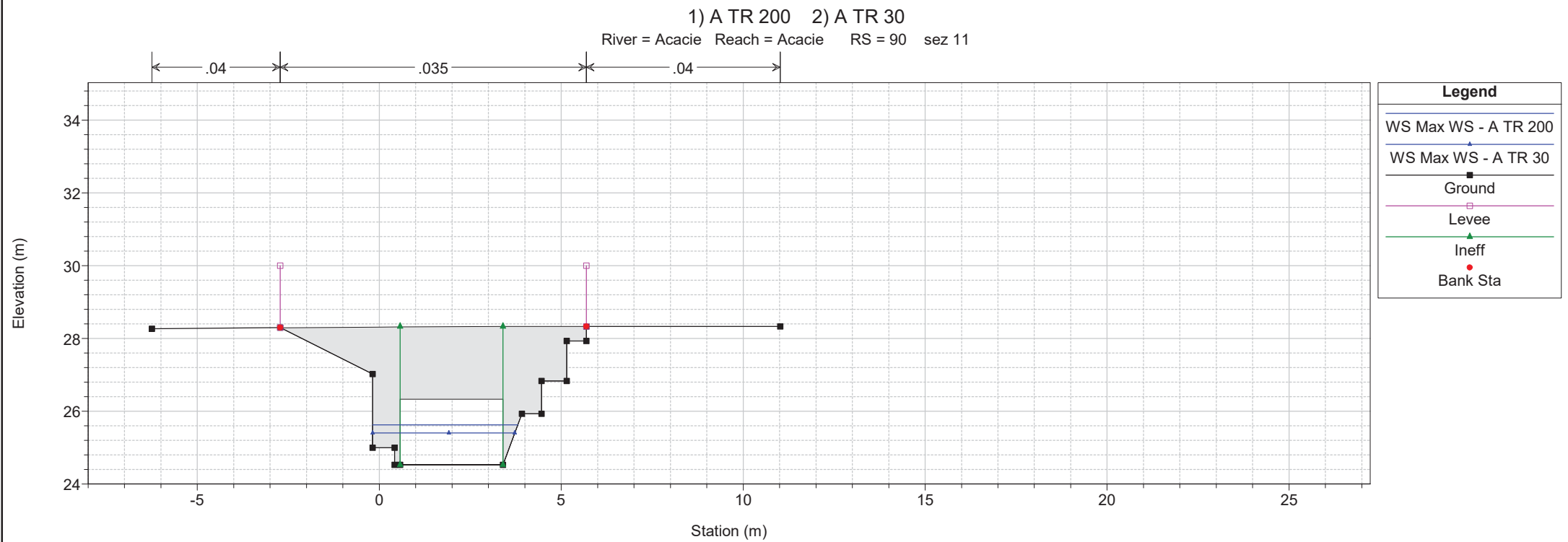
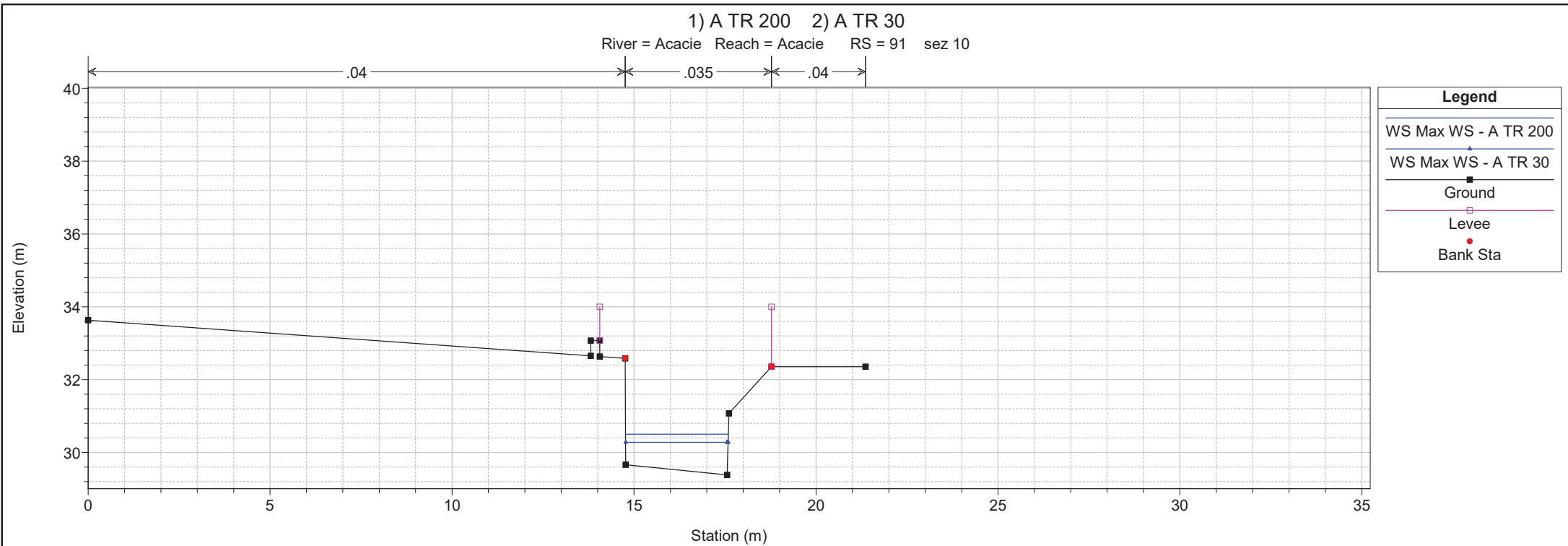

1 cm Horiz. = 1.5 m 1 cm Vert. = 1.5 m

1) A TR 200 2) A TR 30
 River = Acacie Reach = Acacie RS = 89.8 sez 12

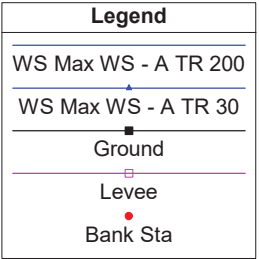
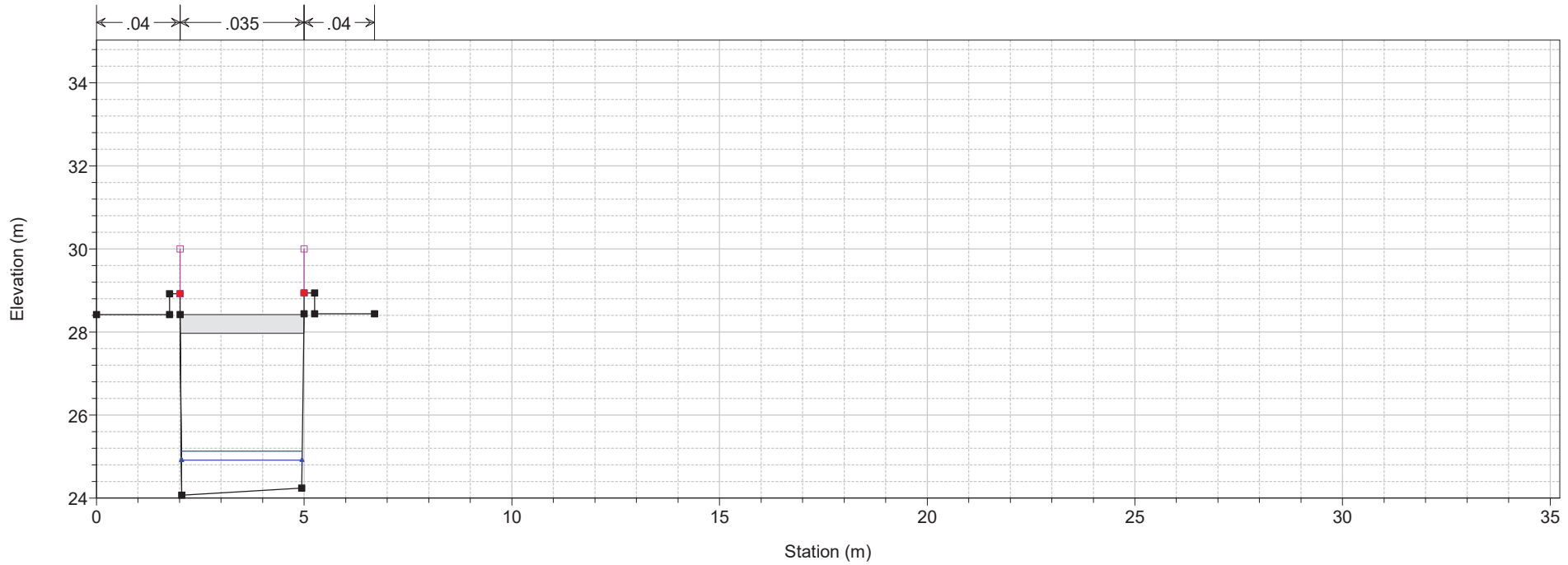

1) A TR 200 2) A TR 30
 River = Acacie Reach = Acacie RS = 88 sez 13

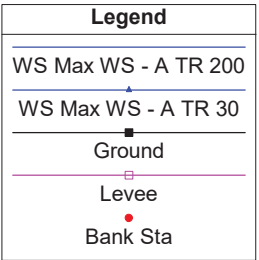
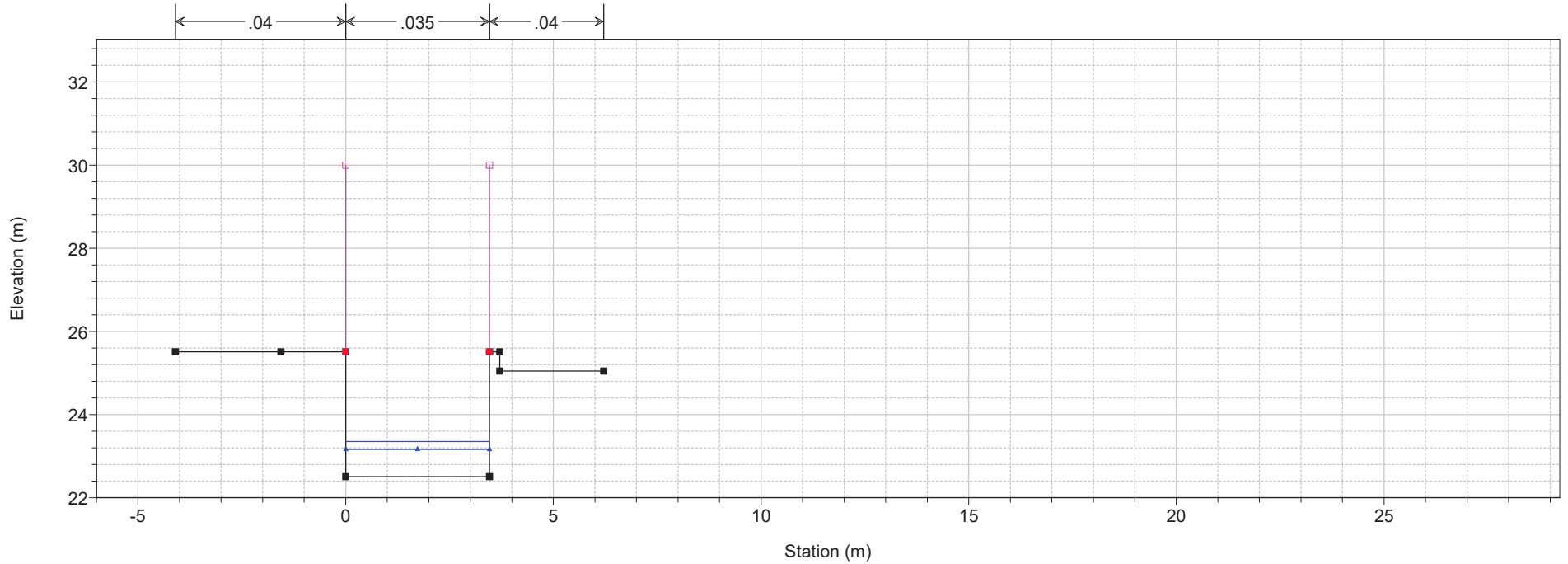

1 cm Horiz. = 1.5 m 1 cm Vert. = 1.5 m

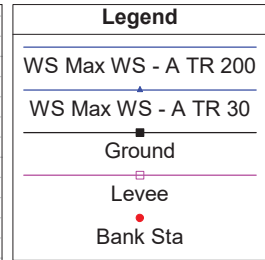
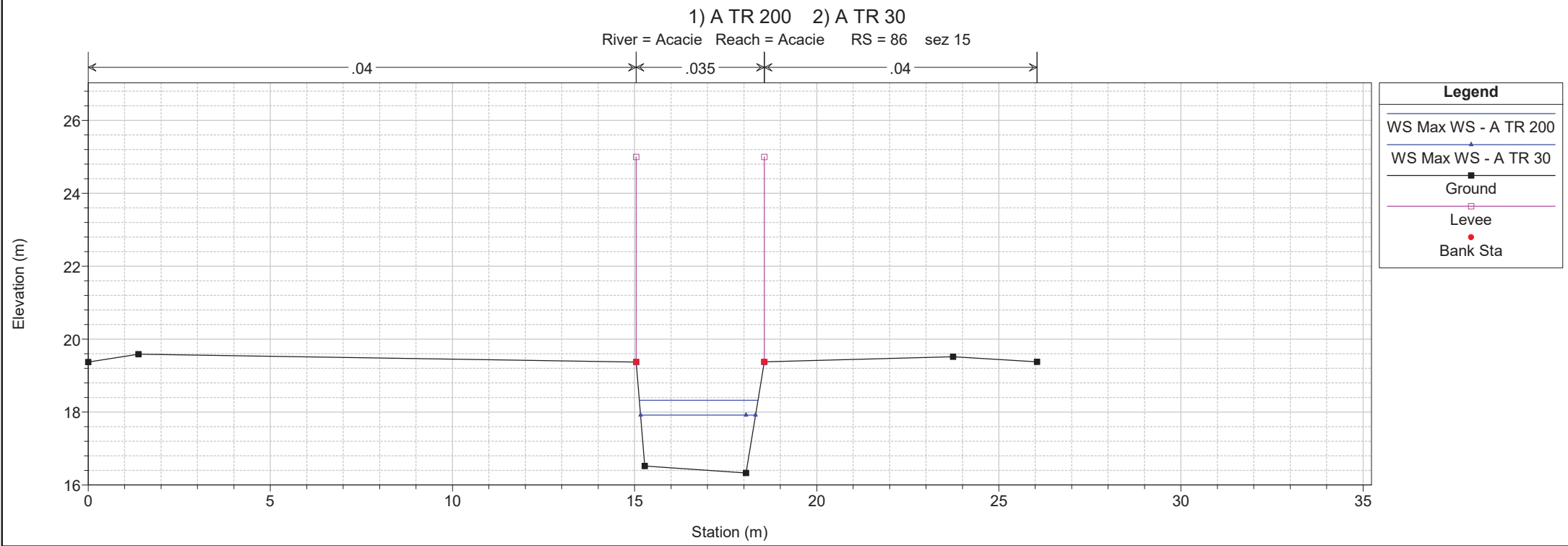
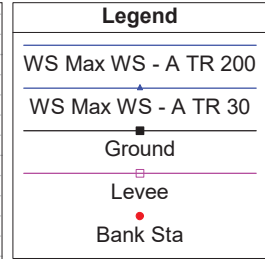
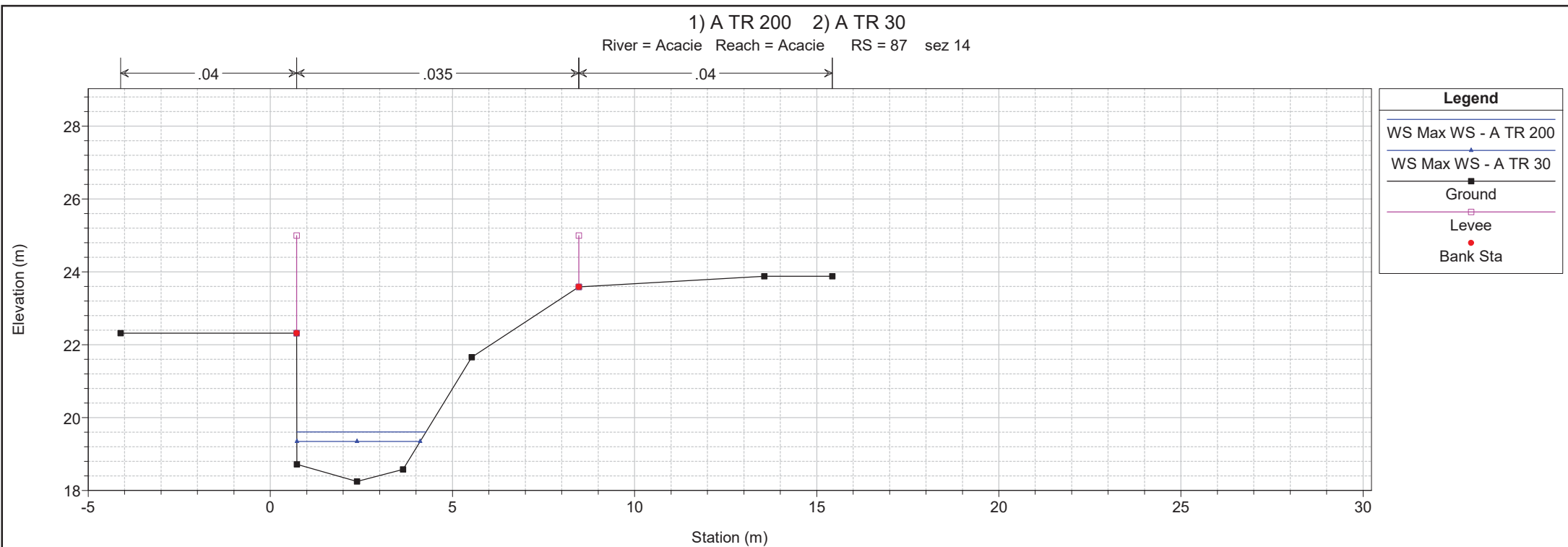

1 cm Horiz. = 1.5 m 1 cm Vert. = 1.5 m

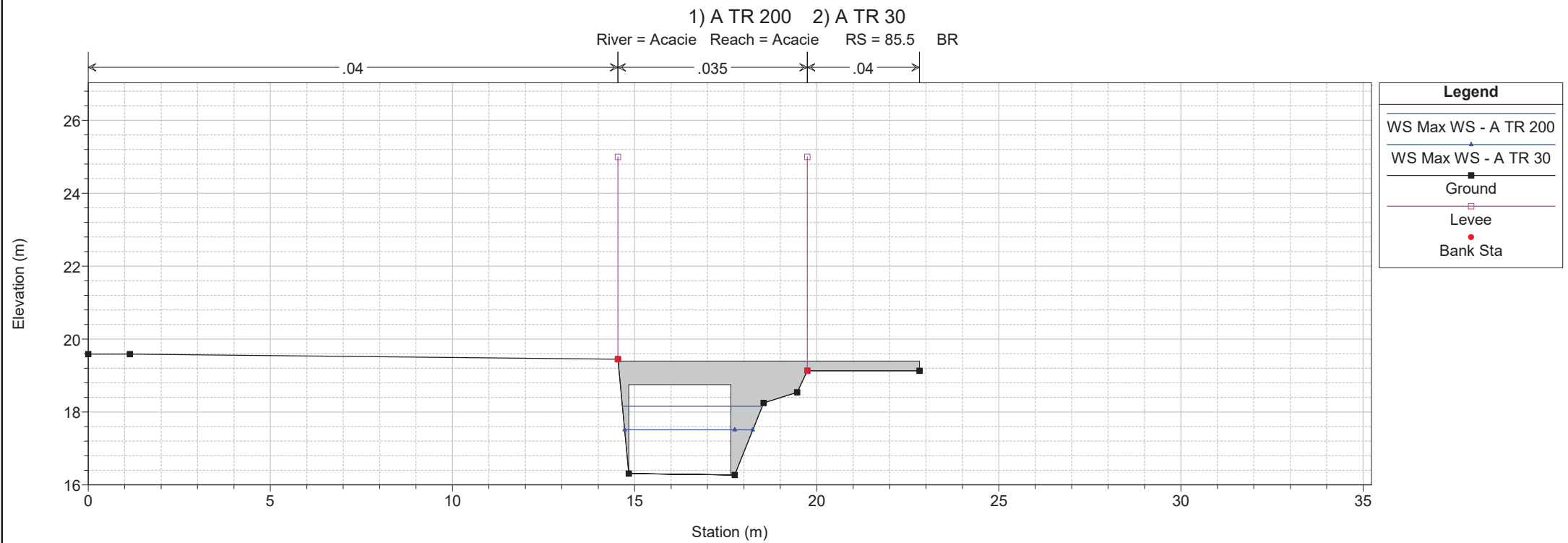
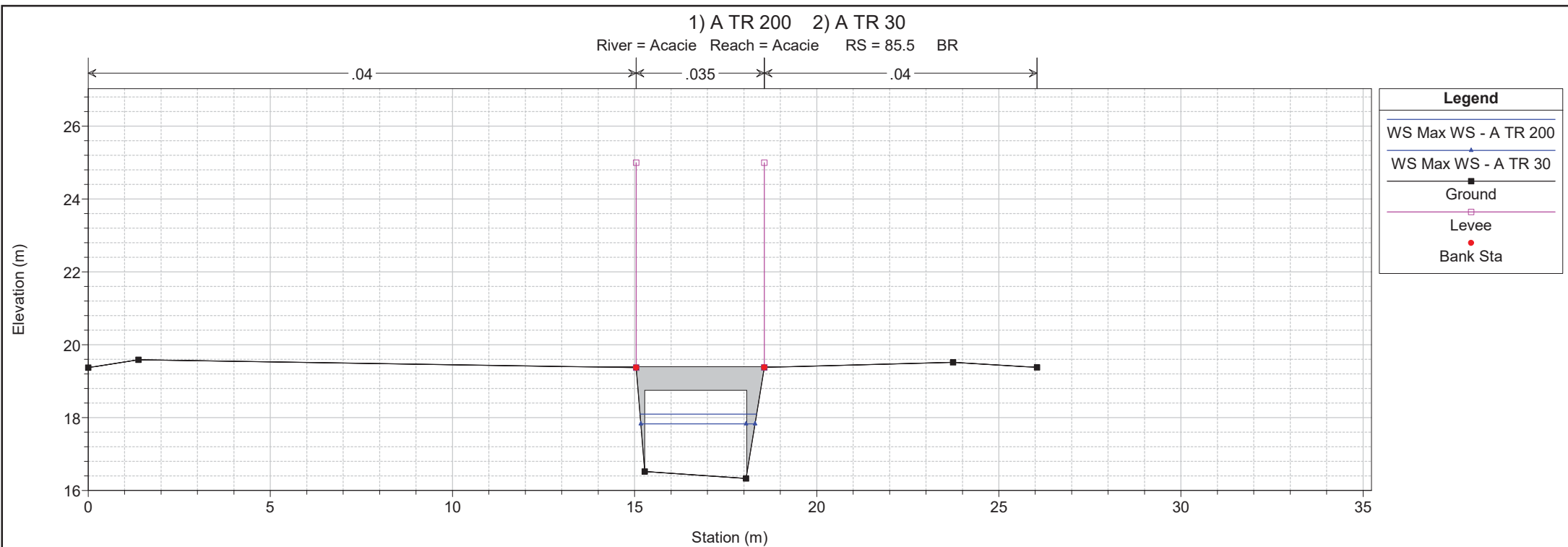

1 cm Horiz. = 1.5 m 1 cm Vert. = 1.5 m

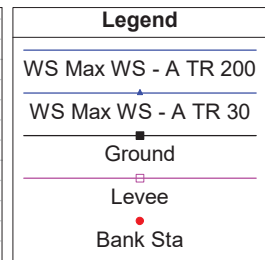
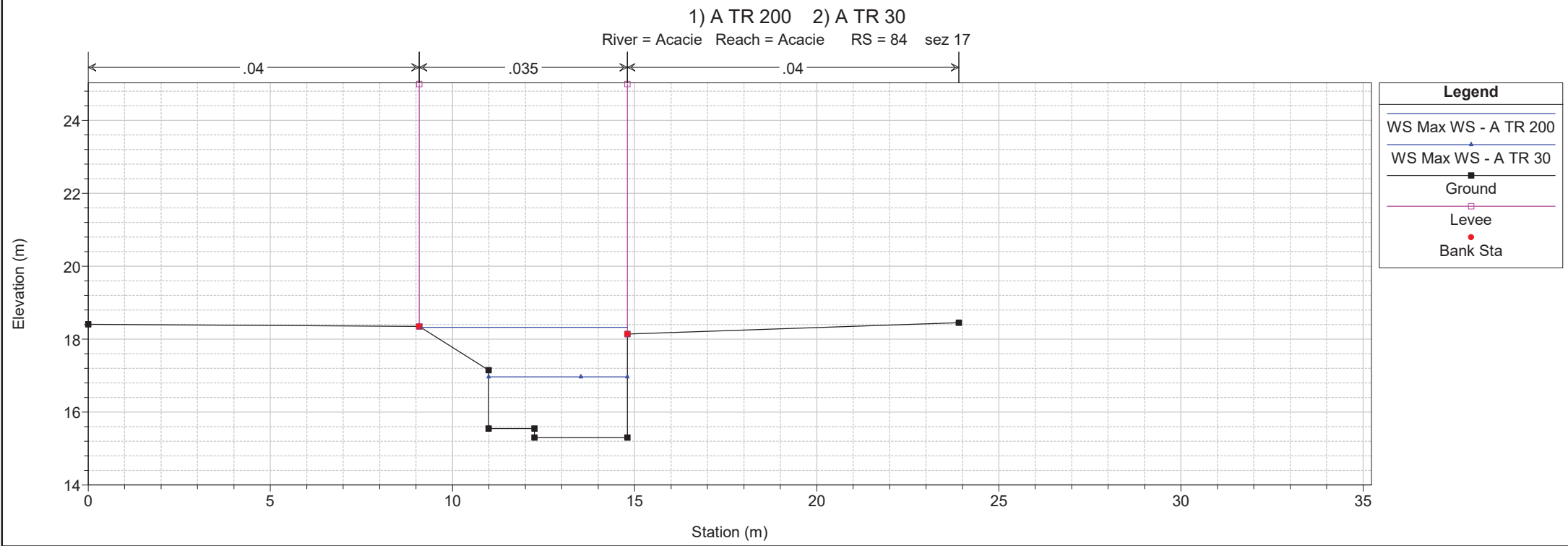
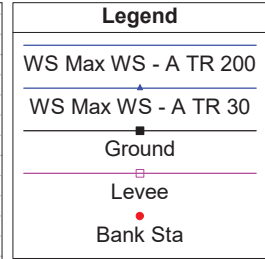
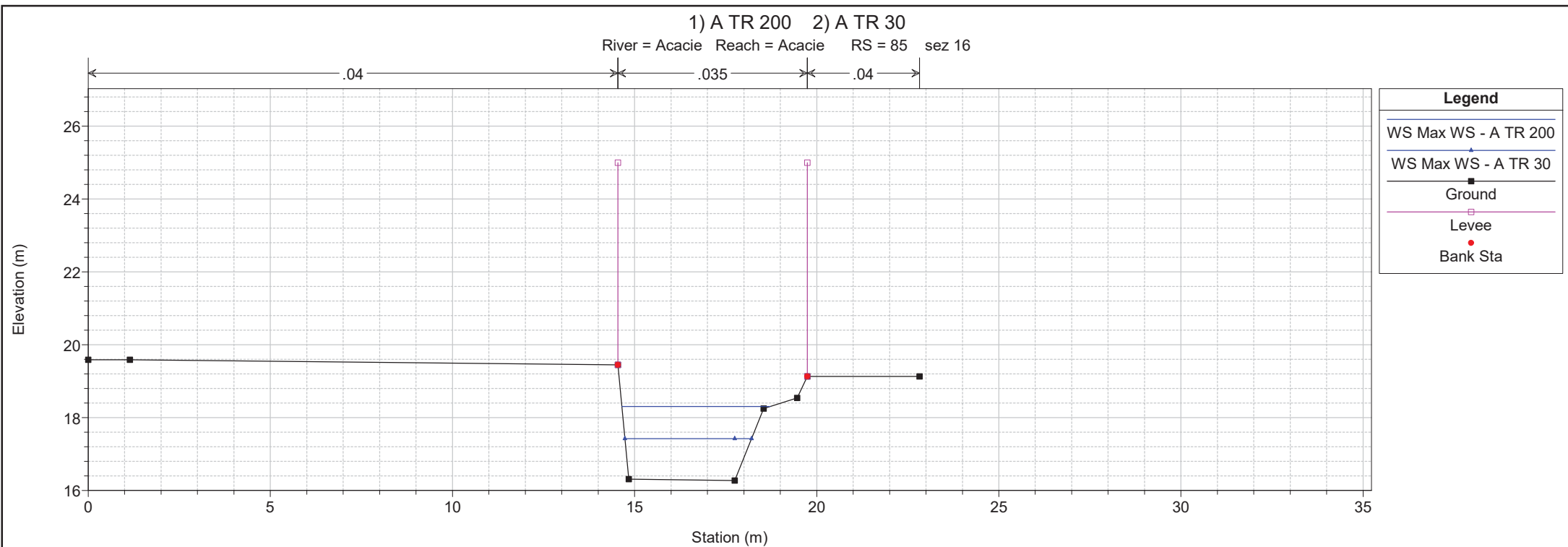

1 cm Horiz. = 1.5 m 1 cm Vert. = 1.5 m

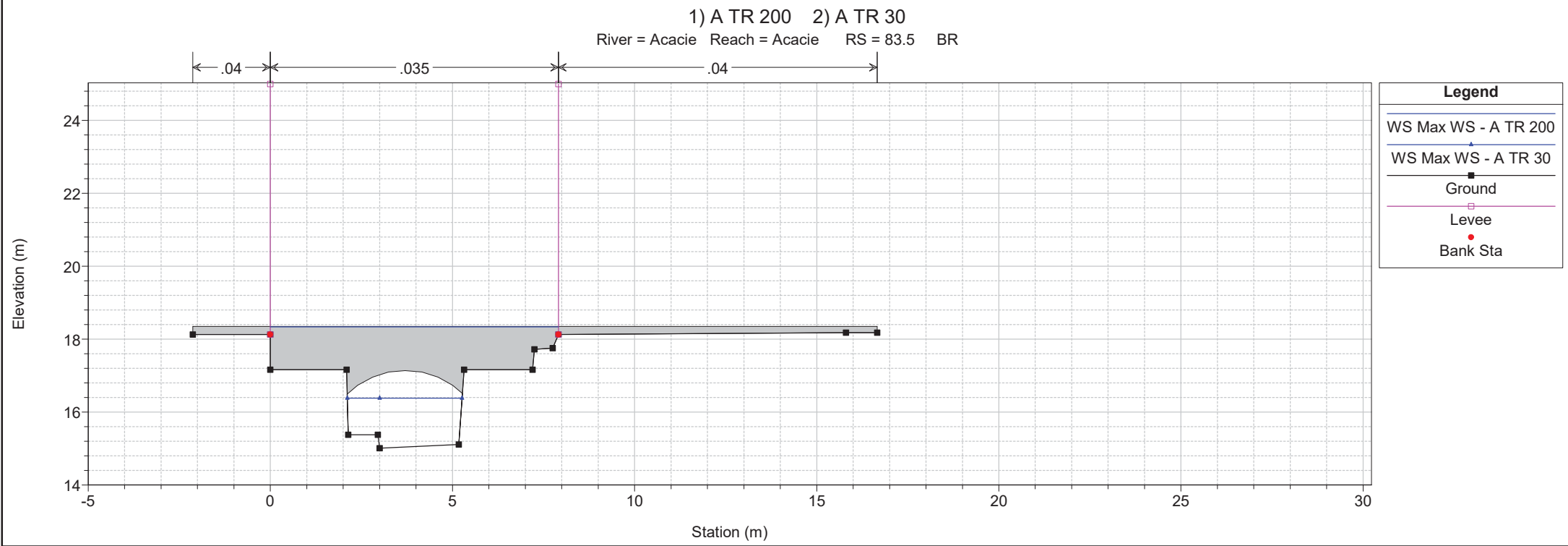
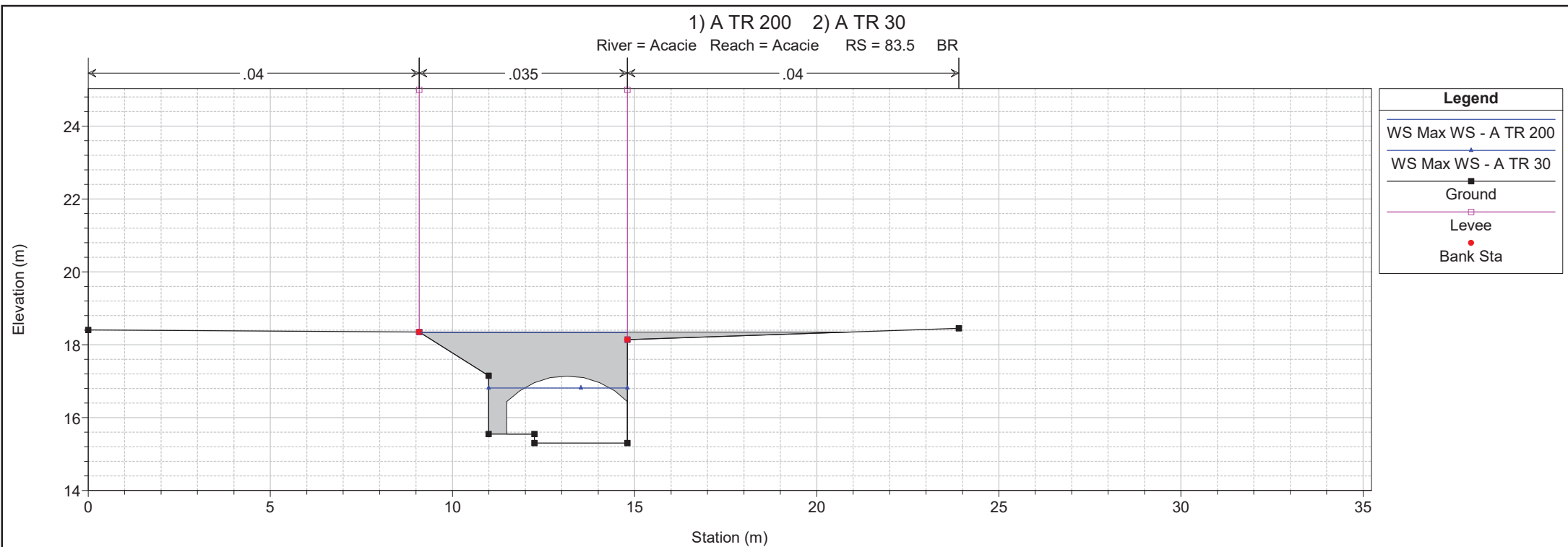

1 cm Horiz. = 1.5 m 1 cm Vert. = 1.5 m

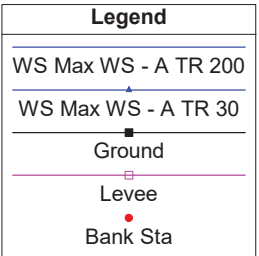
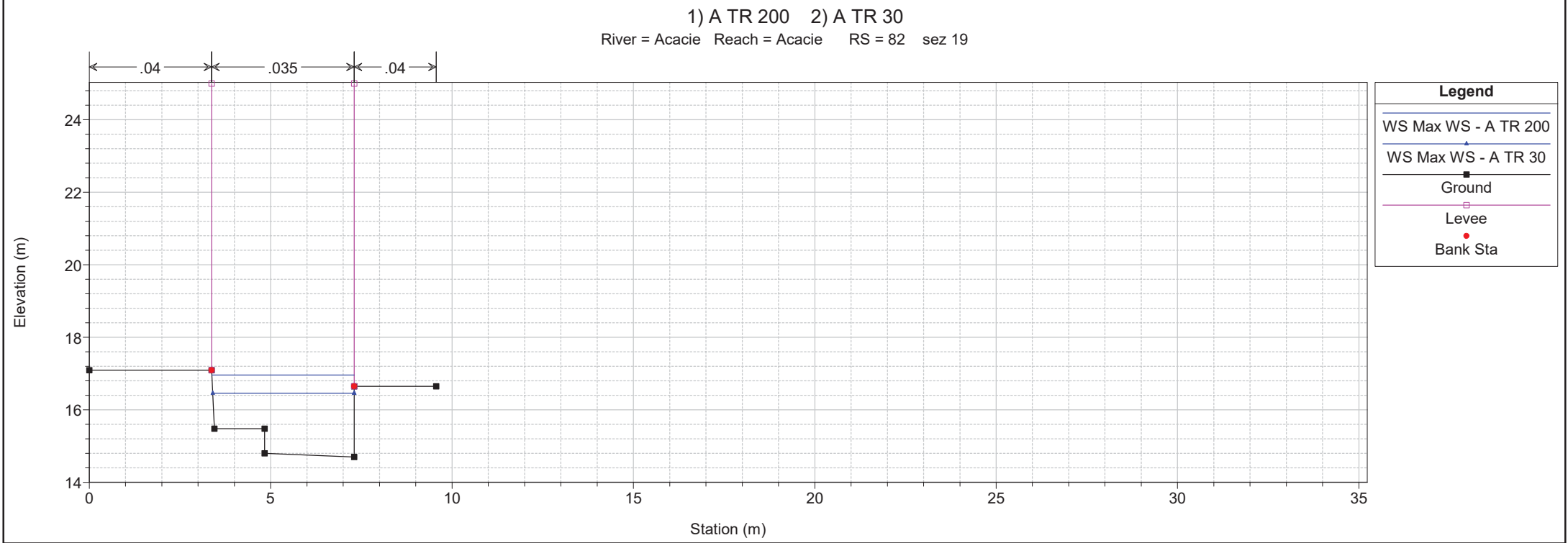
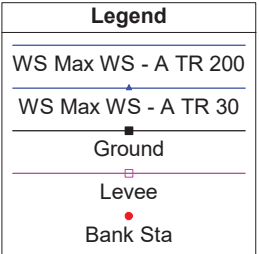
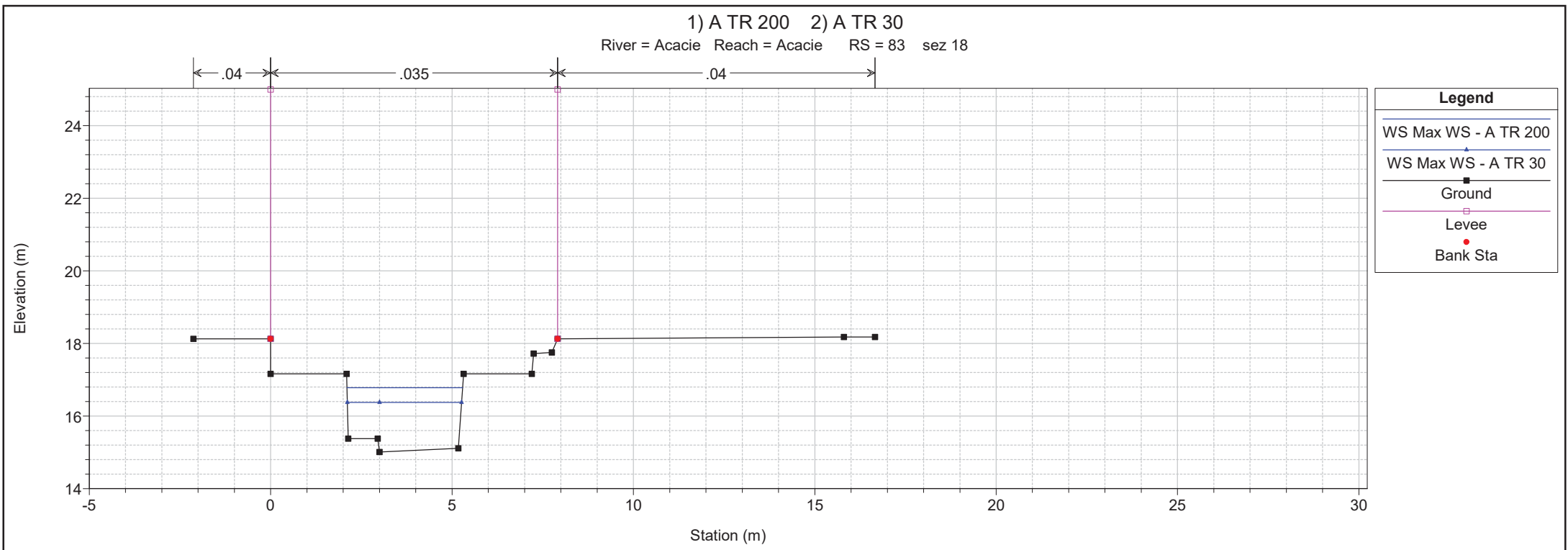

1 cm Horiz. = 1.5 m 1 cm Vert. = 1.5 m

1) A TR 200 2) A TR 30
 River = Acacie Reach = Acacie RS = 81.5 BR

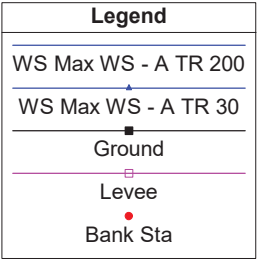
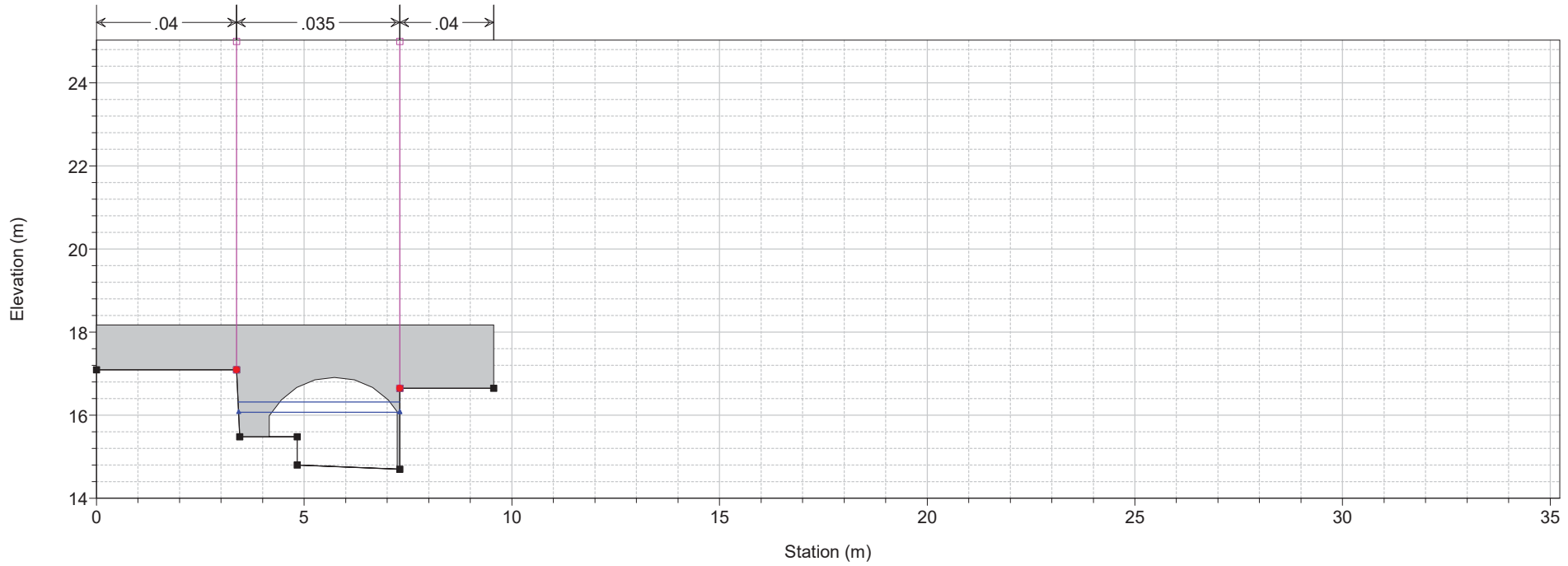

1) A TR 200 2) A TR 30
 River = Acacie Reach = Acacie RS = 81.5 BR

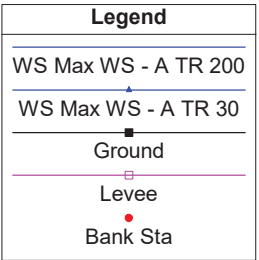
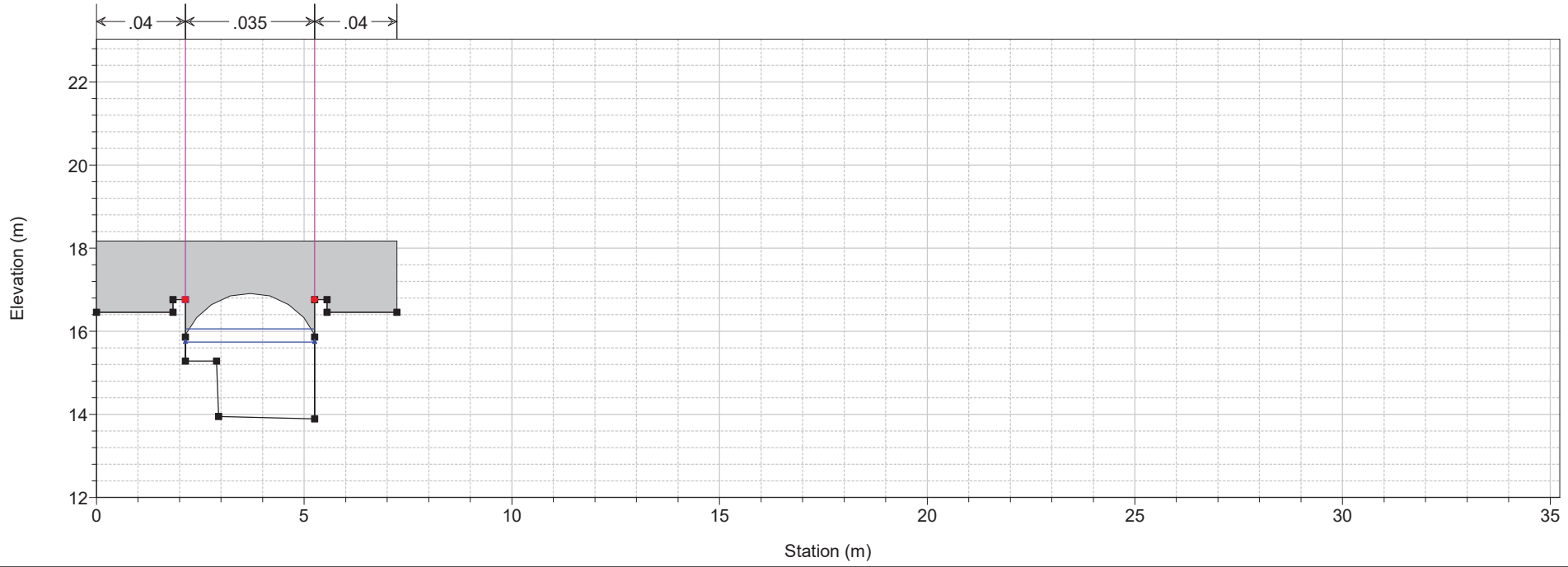

1 cm Horiz. = 1.5 m 1 cm Vert. = 1.5 m

1) A TR 200 2) A TR 30
 River = Acacie Reach = Acacie RS = 81 sez 20

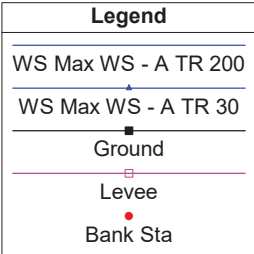
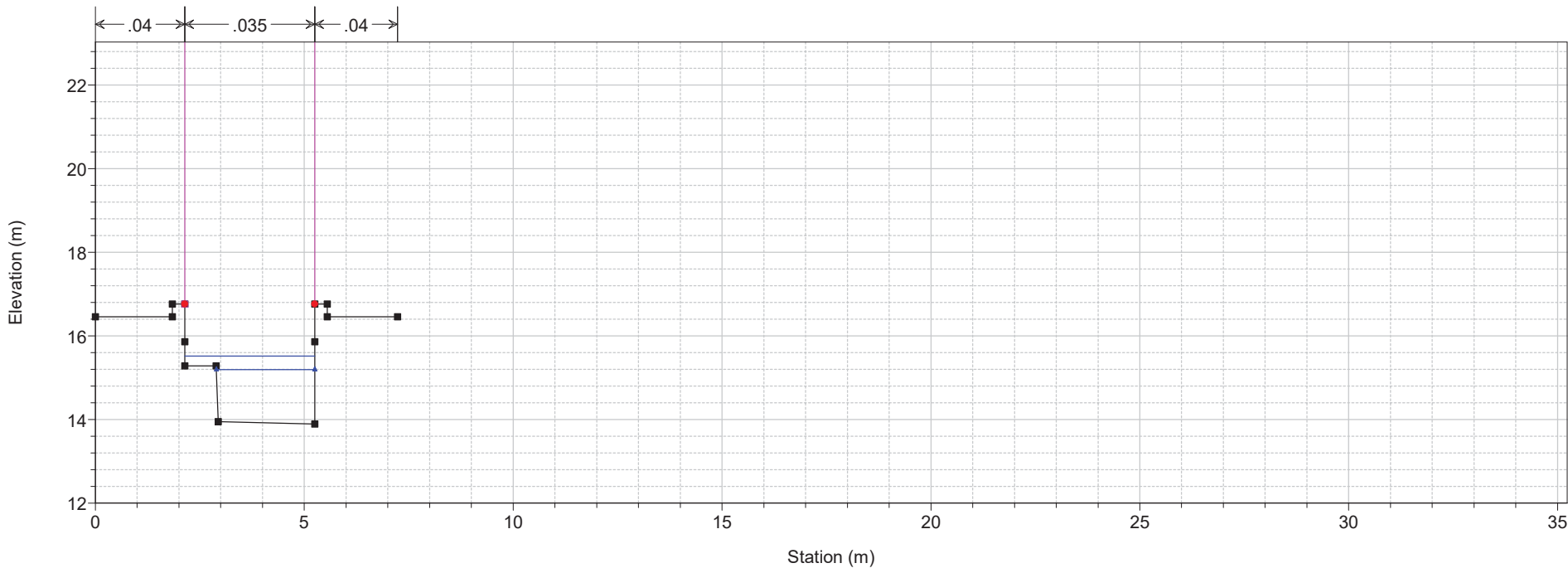

1) A TR 200 2) A TR 30
 River = Acacie Reach = Acacie RS = 80.6

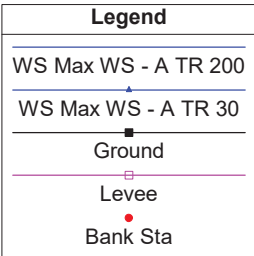
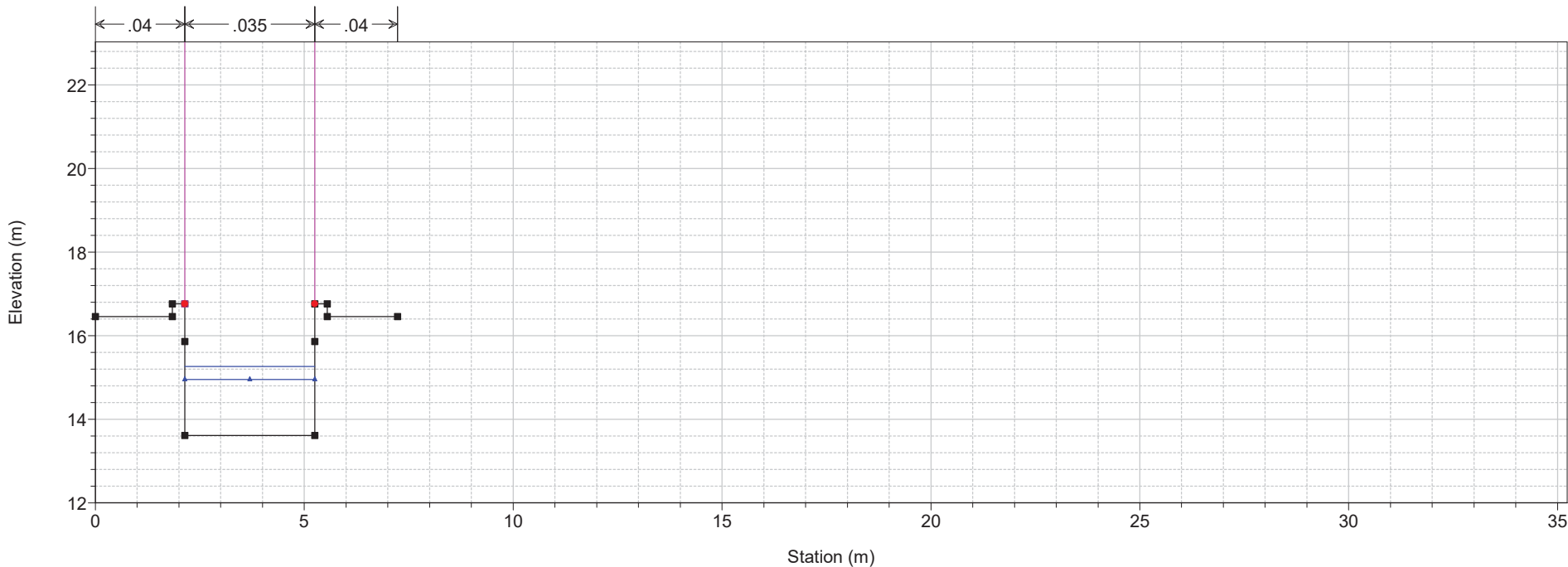

1 cm Horiz. = 1.5 m 1 cm Vert. = 1.5 m

1) A TR 200 2) A TR 30
River = Acacie Reach = Acacie RS = 80.5 IS

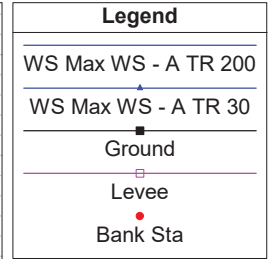
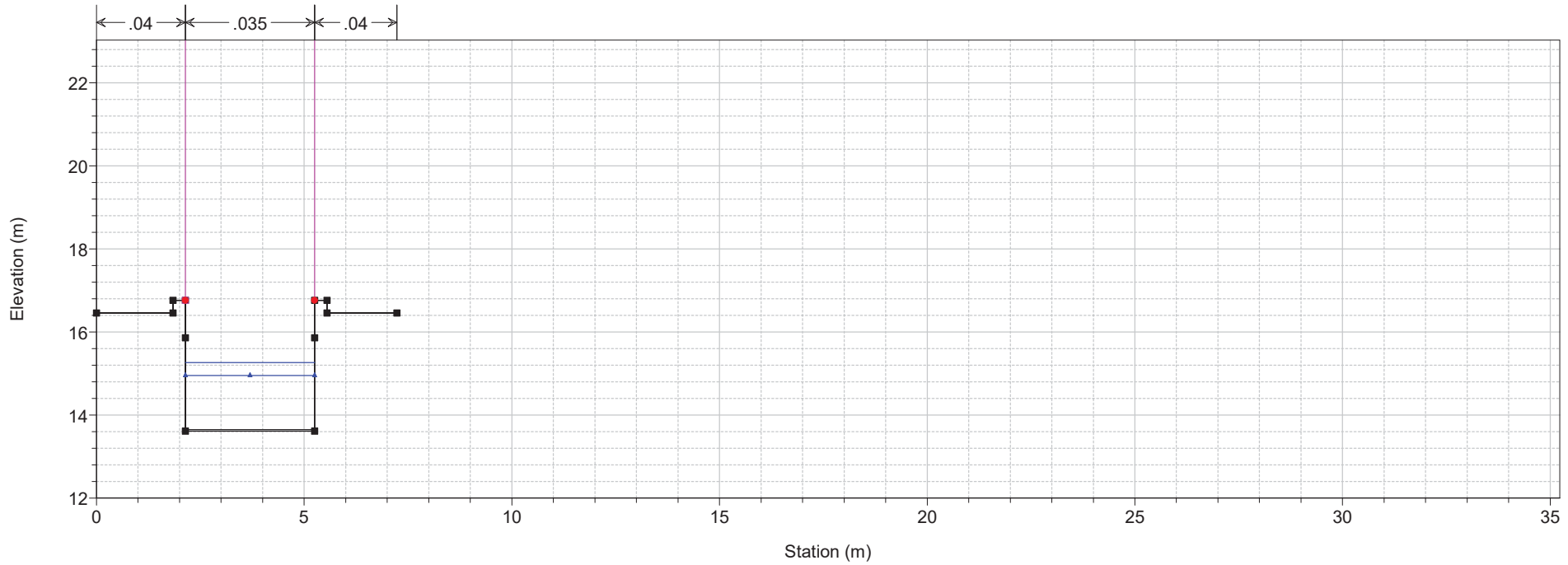

1) A TR 200 2) A TR 30
River = Acacie Reach = Acacie RS = 80.4

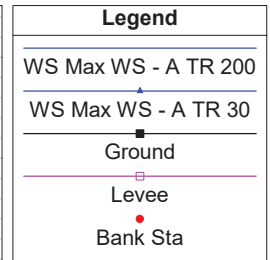
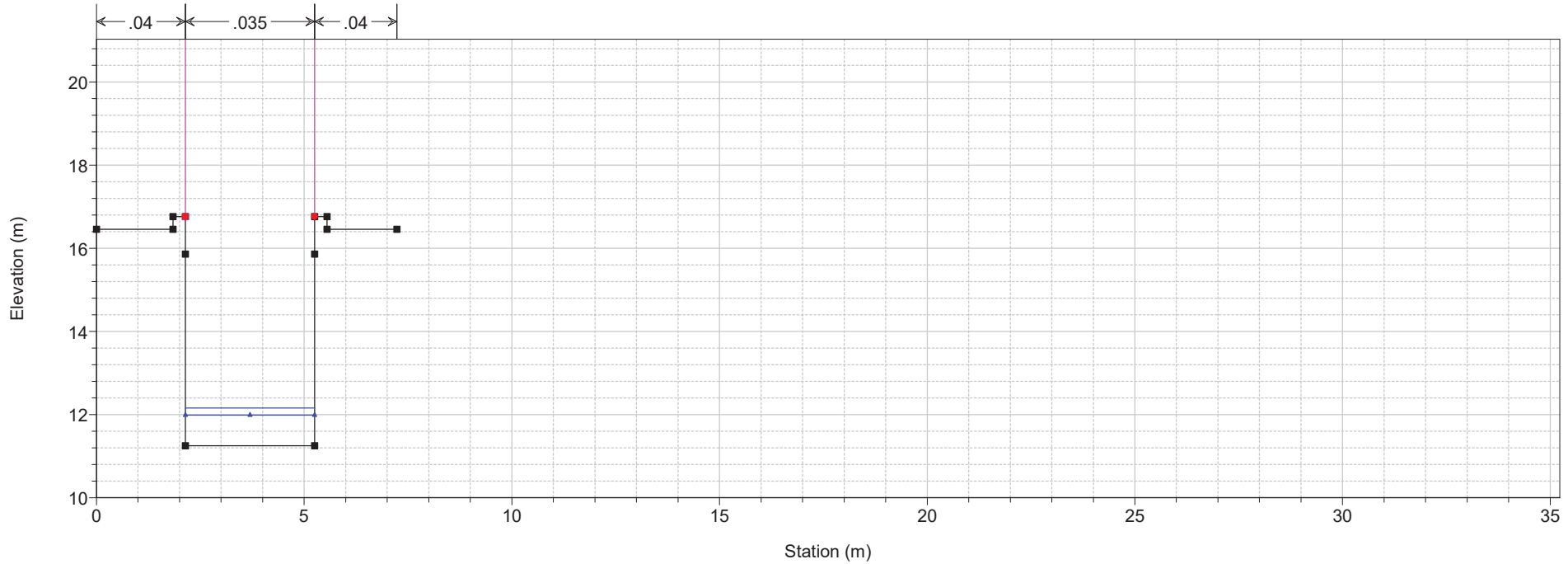

1 cm Horiz. = 1.5 m 1 cm Vert. = 1.5 m

1) A TR 200 2) A TR 30

River = Acacie Reach = Acacie RS = 80 sez 21

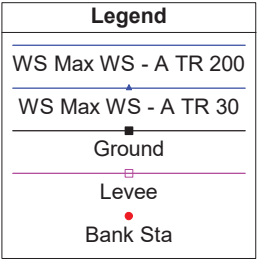
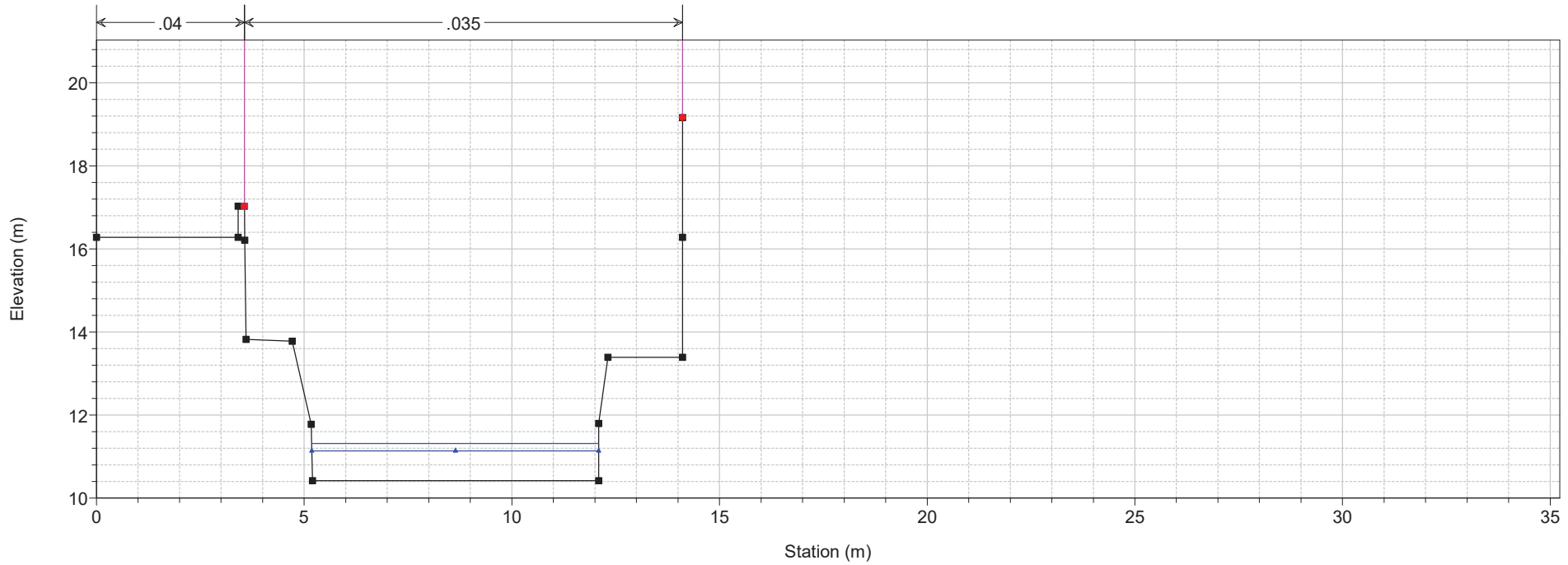

1) A TR 200 2) A TR 30

River = Acacie Reach = Acacie RS = 79.5 BR

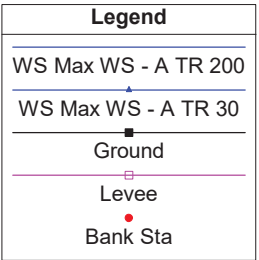
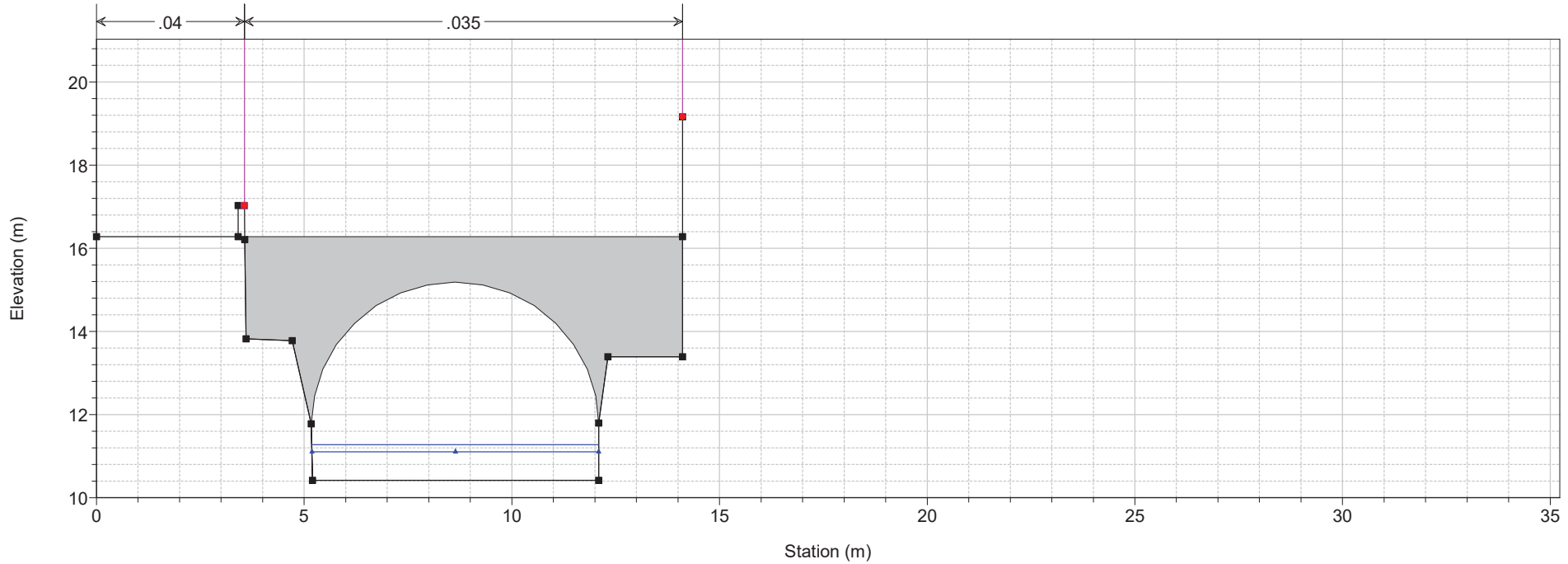

1) A TR 200 2) A TR 30

River = Acacie Reach = Acacie RS = 79.5 BR

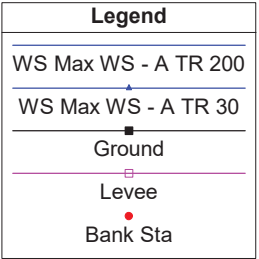
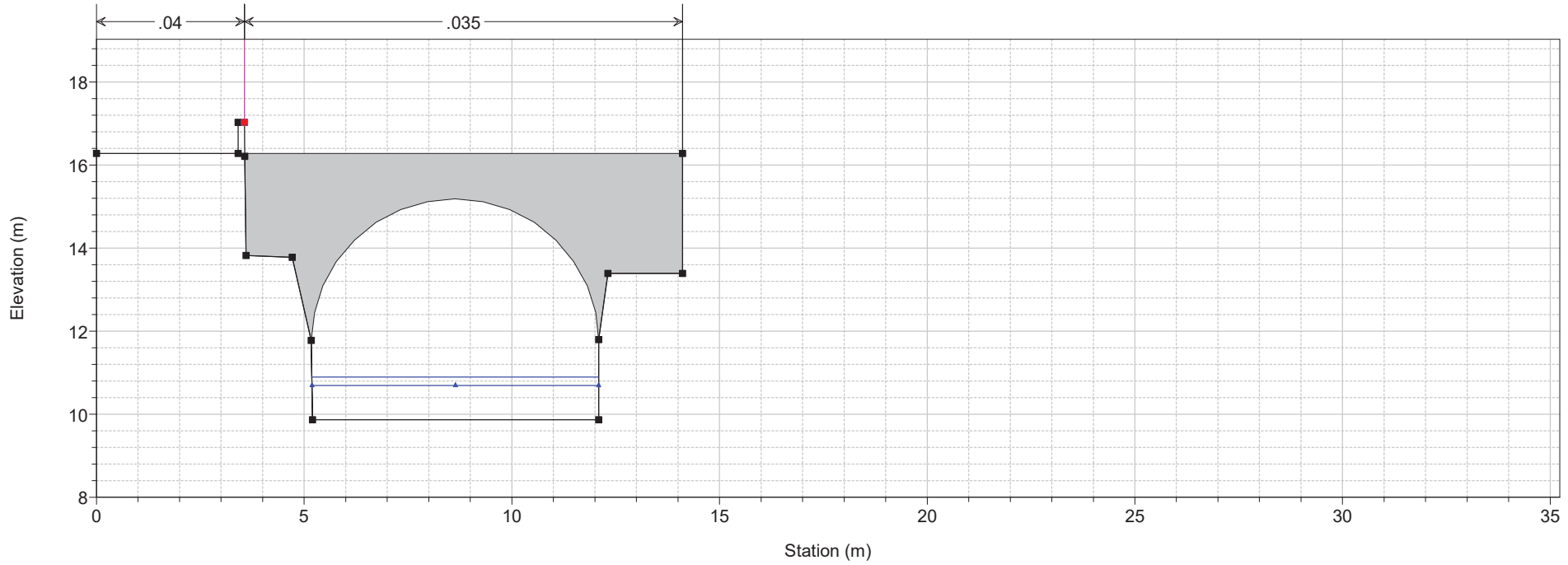

1) A TR 200 2) A TR 30

River = Acacie Reach = Acacie RS = 79.3 sez 21

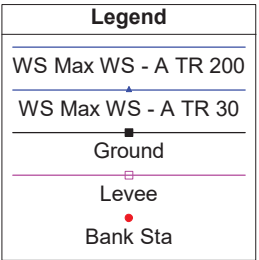
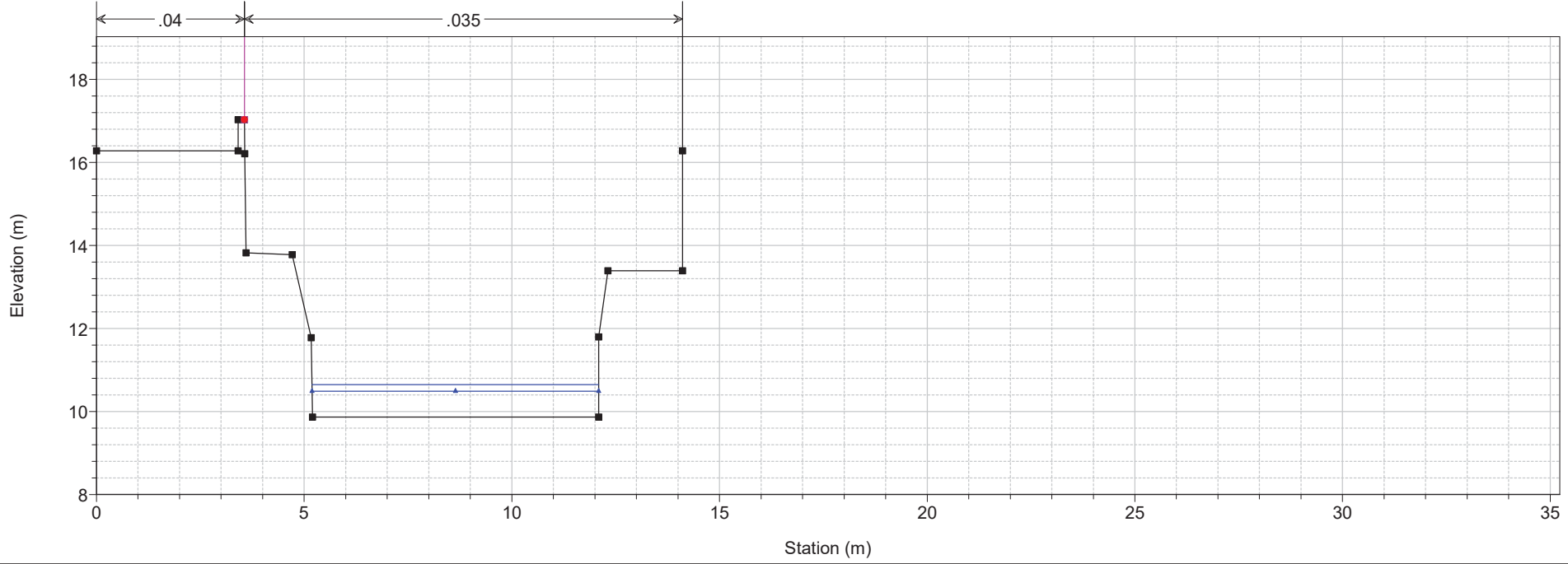

1 cm Horiz. = 1.5 m 1 cm Vert. = 1.5 m

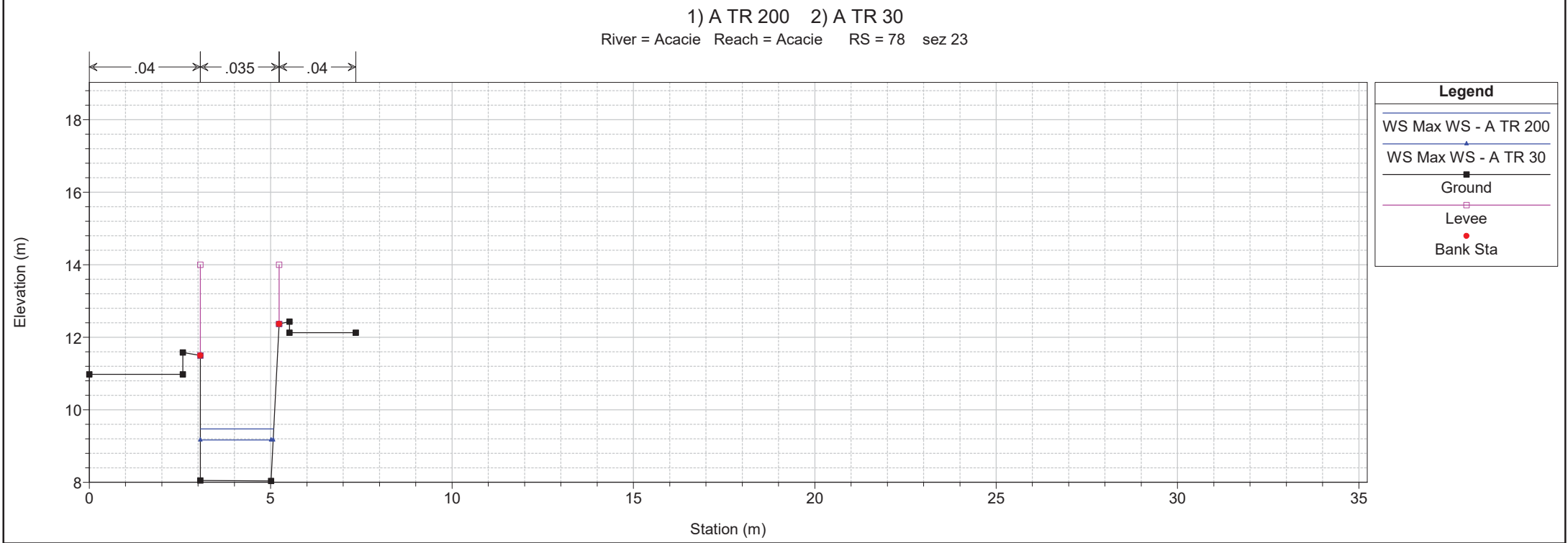
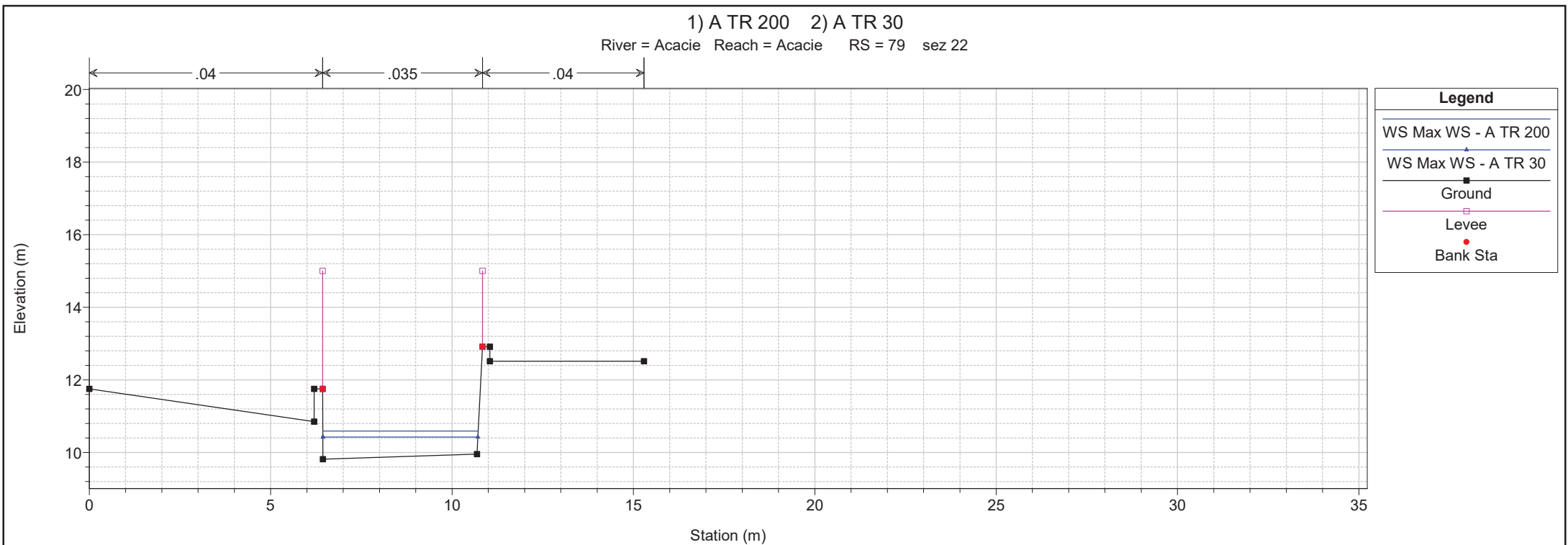

1 cm Horiz. = 1.5 m 1 cm Vert. = 1.5 m

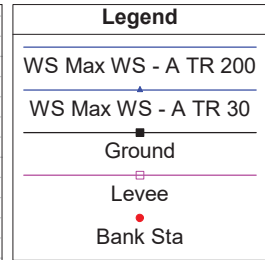
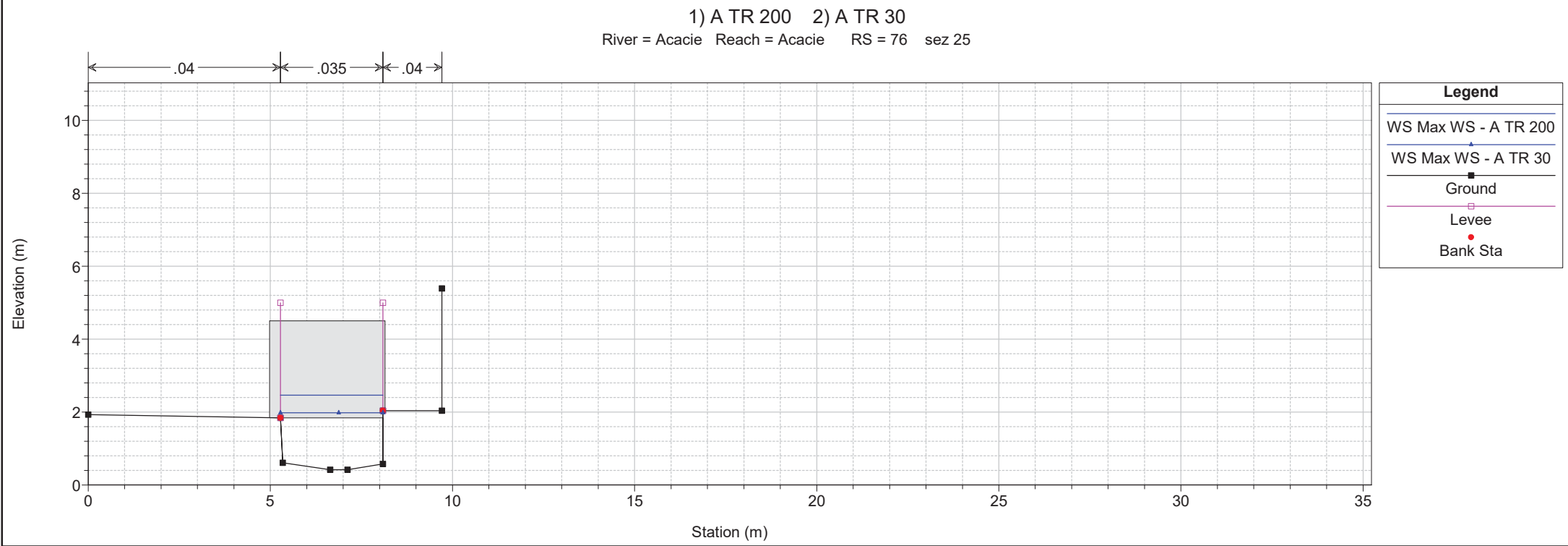
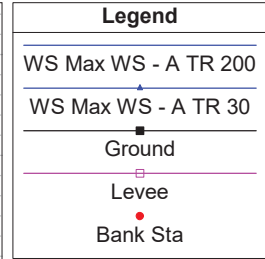
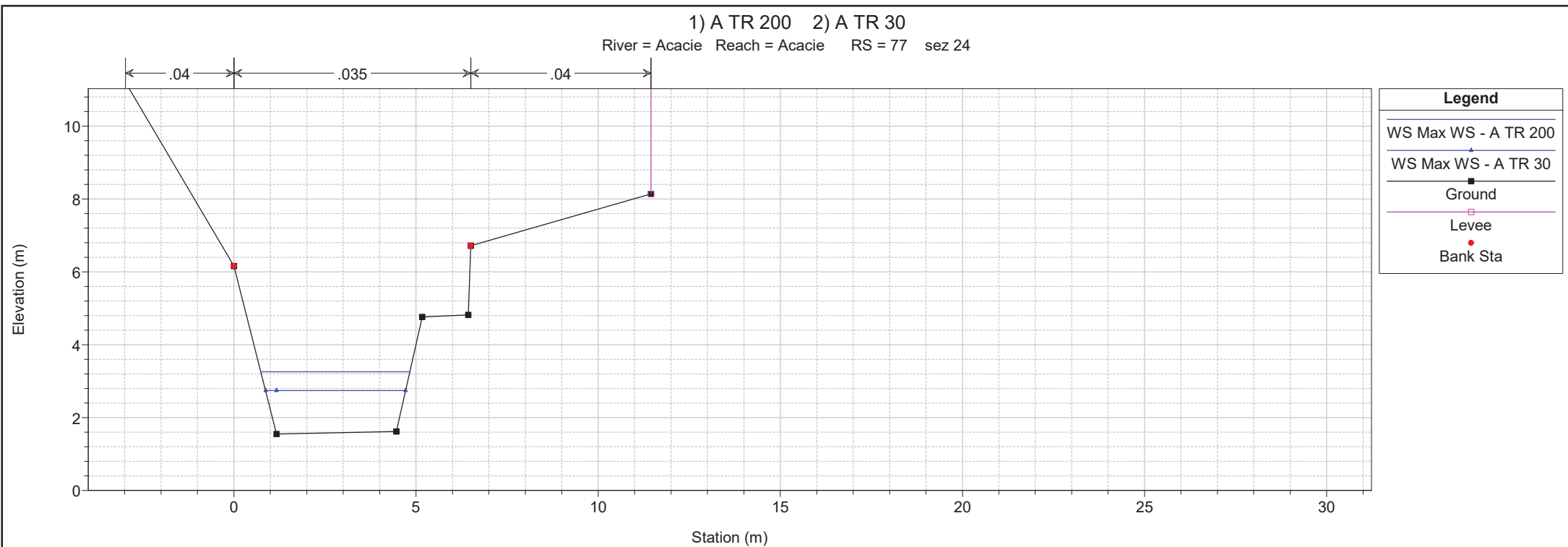

1 cm Horiz. = 1.5 m 1 cm Vert. = 1.5 m

1) A TR 200 2) A TR 30
 River = Acacie Reach = Acacie RS = 75 sez 26

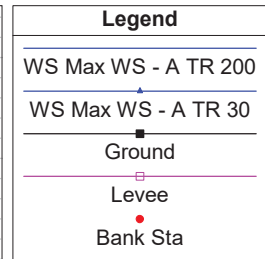
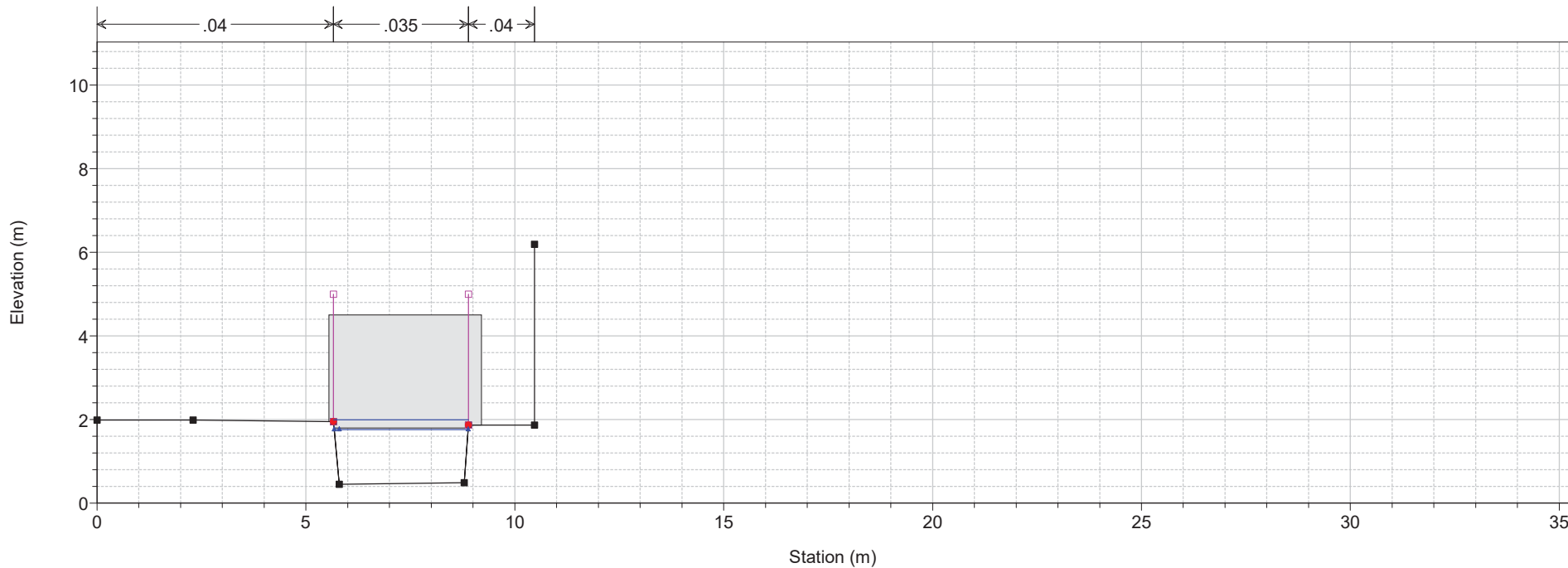

1) A TR 200 2) A TR 30
 River = Acacie Reach = Acacie RS = 74 sez 27

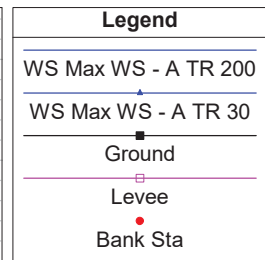
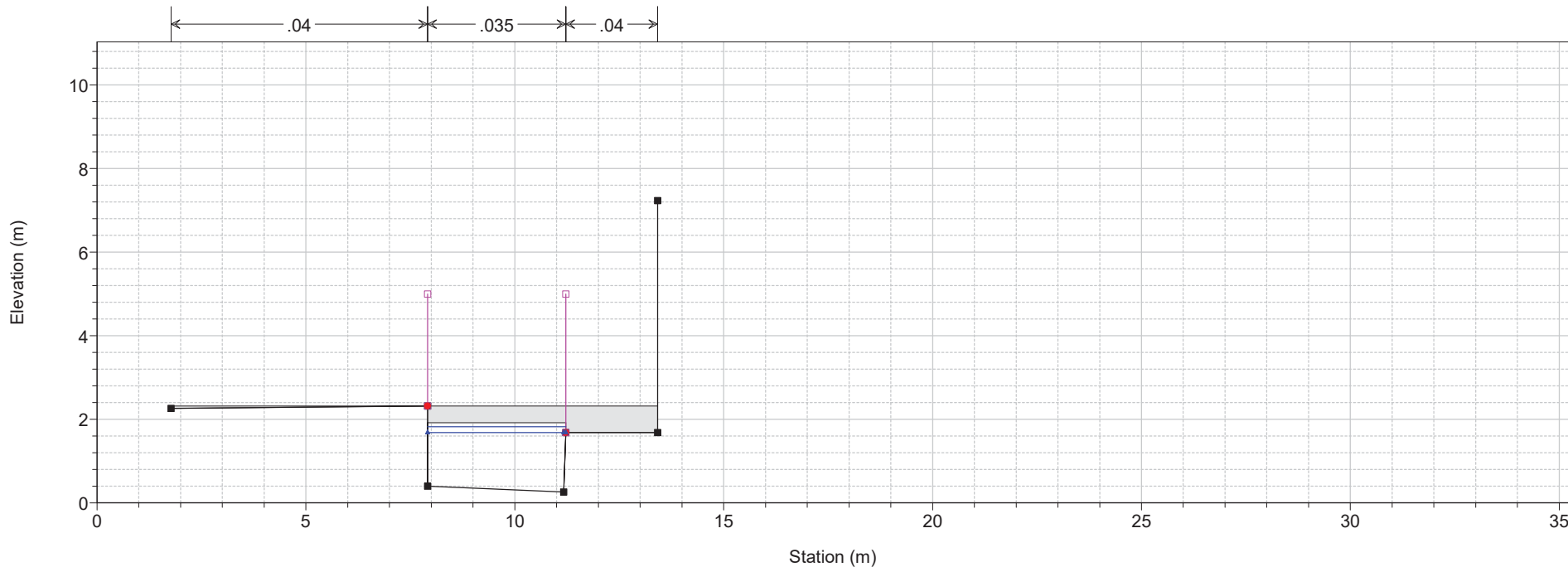

1 cm Horiz. = 1.5 m 1 cm Vert. = 1.5 m

1) A TR 200 2) A TR 30
River = Acacie Reach = Acacie RS = 73.4 sez 27

← .04 → ← .035 → ← .04 →

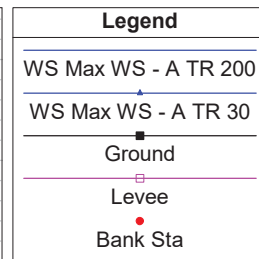
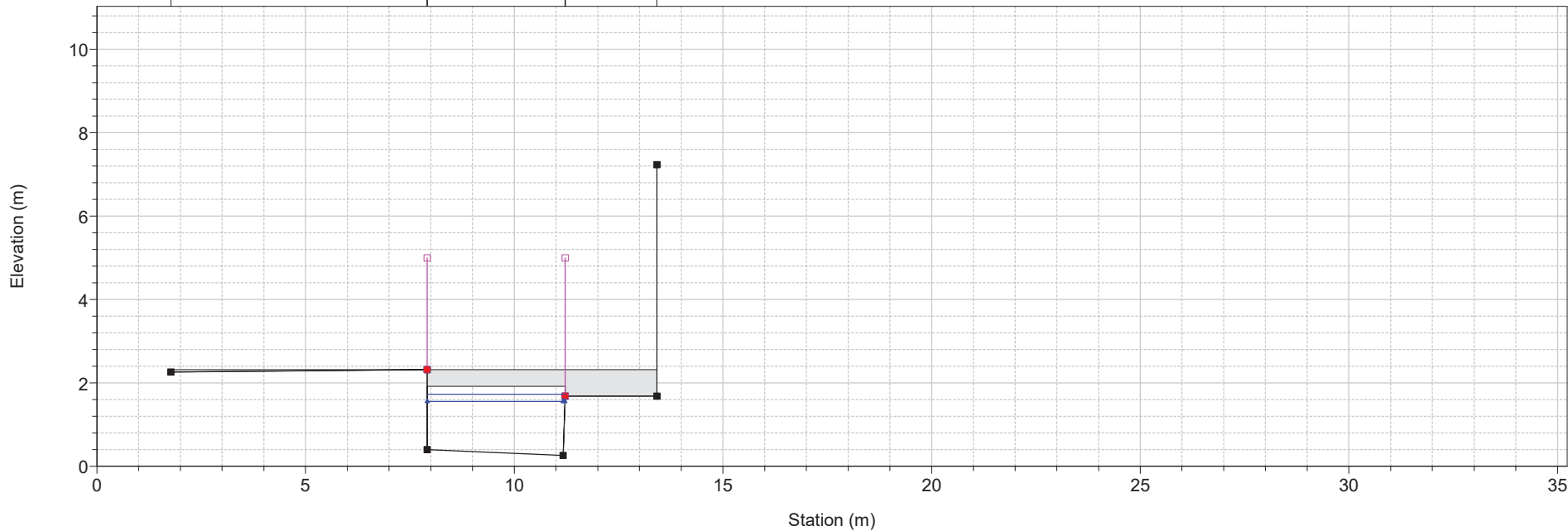

1) A TR 200 2) A TR 30
River = Acacie Reach = Acacie RS = 73.3 sez. 28

← .04 → ← .035 → ← .04 →

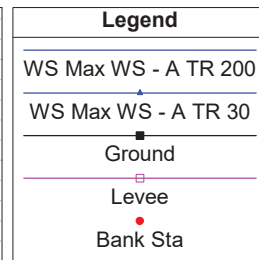
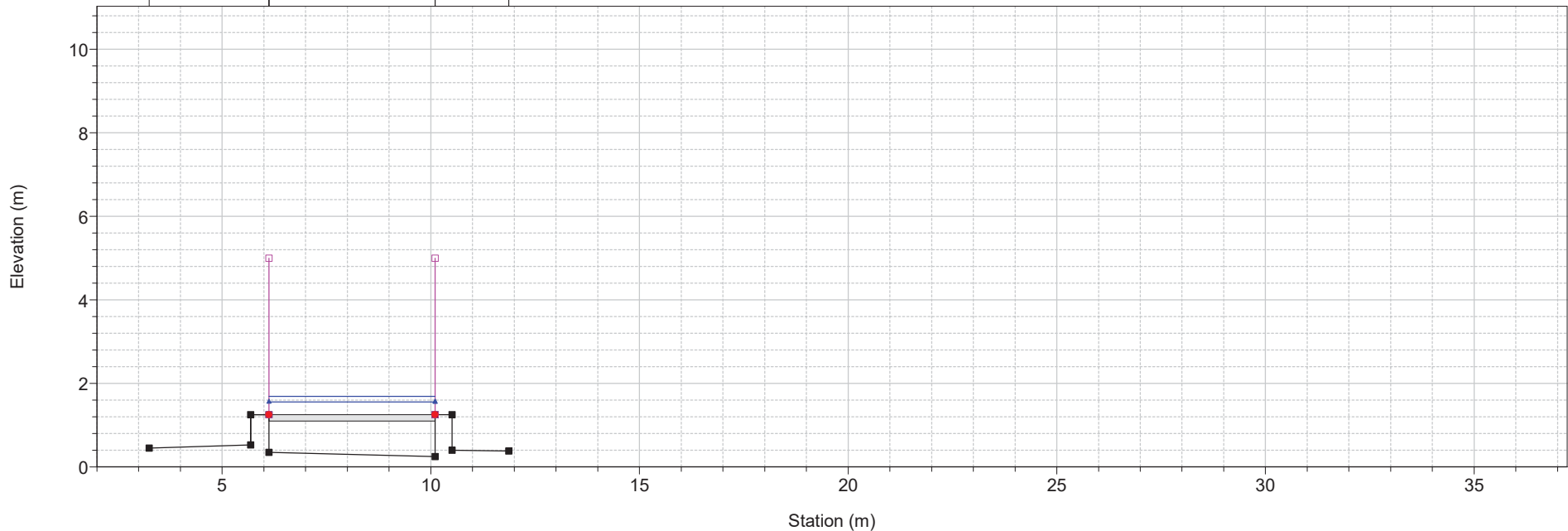

1) A TR 200 2) A TR 30
 River = Acacie Reach = Acacie RS = 73.01 sez. 28

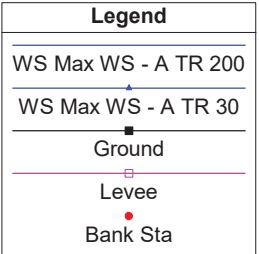
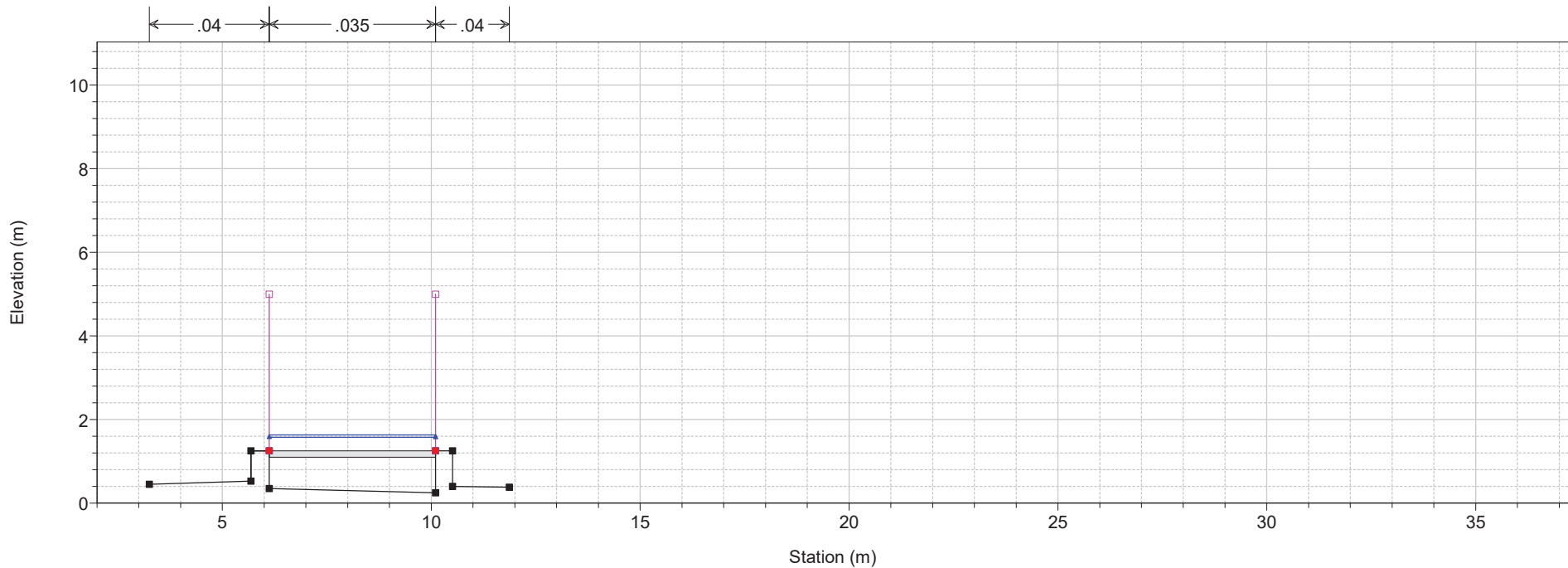

1) A TR 200 2) A TR 30
 River = Acacie Reach = Acacie RS = 73 sez. 28

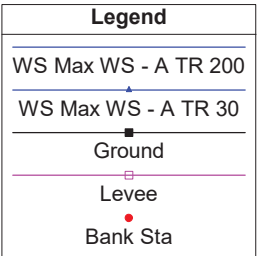
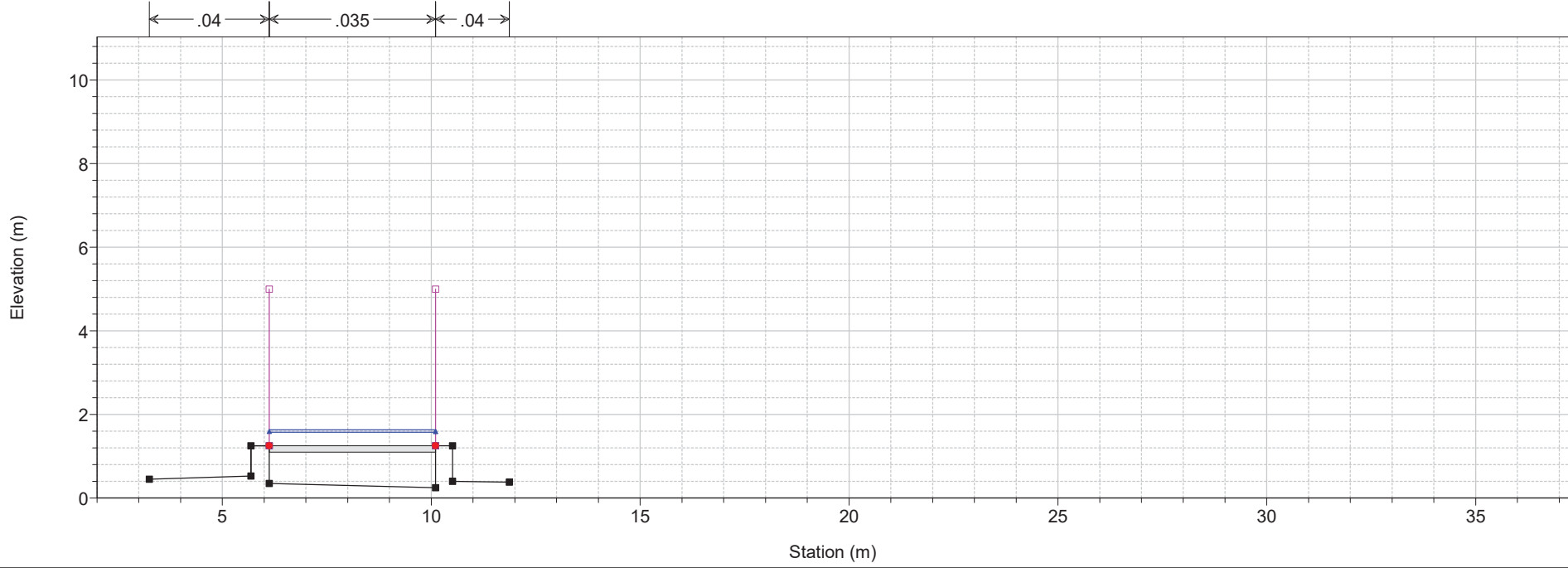

1 cm Horiz. = 1.5 m 1 cm Vert. = 1.5 m

Reach	River Sta	Plan	Q Total (m3/s)	Min Ch El (m)	W.S. Elev (m)	Crit W.S. (m)	E.G. Elev (m)	E.G. Slope (m/m)	Vel Chnl (m/s)	Flow Area (m2)	Top Width (m)	Froude # Chl
Acacie	82.997		Lat Struct									
Acacie	82	A TR 200	17.00	14.70	16.96	16.27	17.22	0.007004	2.25	7.55	3.92	0.52
Acacie	82	A TR 30	12.13	14.70	16.45	16.02	16.70	0.008239	2.18	5.58	3.90	0.58
Acacie	81.5		Bridge									
Acacie	81	A TR 200	17.00	13.89	15.52	15.71	16.48	0.043282	4.35	3.91	3.11	1.24
Acacie	81	A TR 30	12.13	13.89	15.20	15.42	16.04	0.039128	4.07	2.98	2.36	1.16
Acacie	80.98		Lat Struct									
Acacie	80.97		Lat Struct									
Acacie	80.6	A TR 200	17.07	13.61	15.26	15.06	15.82	0.018157	3.32	5.14	3.11	0.82
Acacie	80.6	A TR 30	12.18	13.61	14.95	14.77	15.39	0.016124	2.92	4.18	3.11	0.80
Acacie	80.5		Inl Struct									
Acacie	80.4	A TR 200	17.07	11.25	12.16	12.70	14.01	0.093328	6.03	2.83	3.11	2.02
Acacie	80.4	A TR 30	12.19	11.25	11.99	12.41	13.42	0.086719	5.31	2.30	3.11	1.97
Acacie	80	A TR 200	17.22	10.42	11.31	11.28	11.71	0.015054	2.79	6.17	6.91	0.94
Acacie	80	A TR 30	12.28	10.42	11.14	11.11	11.45	0.015024	2.48	4.96	6.91	0.93
Acacie	79.5		Bridge									
Acacie	79.3	A TR 200	17.22	9.87	10.65	10.73	11.17	0.023349	3.22	5.35	6.90	1.17
Acacie	79.3	A TR 30	12.28	9.87	10.49	10.56	10.91	0.024041	2.88	4.26	6.90	1.17
Acacie	79	A TR 200	17.23	9.81	10.59	11.06	12.25	0.092425	5.71	3.02	4.29	2.17
Acacie	79	A TR 30	12.28	9.81	10.42	10.83	11.85	0.104486	5.30	2.32	4.28	2.30
Acacie	78	A TR 200	17.40	8.04	9.47	10.04	11.39	0.092819	6.13	2.84	2.02	1.65
Acacie	78	A TR 30	12.37	8.04	9.17	9.64	10.74	0.087980	5.55	2.23	2.01	1.68
Acacie	77	A TR 200	18.44	1.55	3.25	3.01	3.71	0.012306	2.99	6.17	4.09	0.78
Acacie	77	A TR 30	12.89	1.55	2.74	2.71	3.24	0.018276	3.13	4.13	3.85	0.96
Acacie	76.98		Lat Struct									
Acacie	76.97		Lat Struct									
Acacie	76	A TR 200	16.49	0.42	2.46	5.00	3.45	0.066442	4.41	3.74		0.98
Acacie	76	A TR 30	13.20	0.42	1.98	1.82	2.62	0.042596	3.53	3.74		0.90
Acacie	75	A TR 200	16.58	0.45	1.99	2.30	2.78	0.053421	3.96	4.37	6.82	1.01
Acacie	75	A TR 30	13.27	0.45	1.76	1.72	2.32	0.021146	3.32	3.99	3.20	0.95
Acacie	74.98		Lat Struct									
Acacie	74.97		Lat Struct									
Acacie	74	A TR 200	16.27	0.26	1.82	1.69	2.38	0.017978	3.31	4.91	3.31	0.87
Acacie	74	A TR 30	13.27	0.26	1.68	1.52	2.14	0.016138	2.98	4.45	3.31	0.82
Acacie	73.4	A TR 200	16.21	0.26	1.72	1.69	2.36	0.021971	3.54	4.58	3.31	0.96
Acacie	73.4	A TR 30	13.27	0.26	1.56	1.52	2.11	0.021132	3.29	4.03	3.31	0.95
Acacie	73.38		Lat Struct									
Acacie	73.37		Lat Struct									
Acacie	73.3	A TR 200	15.88	0.25	1.69	1.63	2.22	0.048806	3.22	4.93	3.98	0.86
Acacie	73.3	A TR 30	13.17	0.25	1.56	1.49	2.01	0.048756	2.99	4.41	3.98	0.83
Acacie	73.01	A TR 200	3.64	0.25	1.63	0.74	1.66	0.003002	0.77	4.70	3.98	0.21
Acacie	73.01	A TR 30	3.36	0.25	1.58	0.72	1.61	0.003001	0.75	4.48	3.98	0.21
Acacie	73	A TR 200	3.64	0.25	1.63	0.74	1.66	0.003004	0.77	4.70	3.98	0.21
Acacie	73	A TR 30	3.36	0.25	1.58	0.72	1.61	0.003004	0.75	4.48	3.98	0.21

Reach	River Sta	Plan	Q US (m3/s)	Q Leaving Total (m3/s)	Q DS (m3/s)	Q Weir (m3/s)	Q Gates (m3/s)	Wr Top Wdth (m)	Weir Max Depth (m)	Weir Avg Depth (m)	Min El Weir Flow (m)	E.G. US. (m)	W.S. US. (m)	E.G. DS (m)	W.S. DS (m)
Acacie	86.998	A TR 200	16.77	0.00	16.48	0.00					19.52	20.66	19.60	18.74	18.32
Acacie	86.998	A TR 30	11.54	0.00	11.83	0.00					19.52	20.22	19.34	18.28	17.92
Acacie	86.997	A TR 200	16.77	0.00	16.48	0.00					19.59	20.66	19.60	18.74	18.32
Acacie	86.997	A TR 30	11.54	0.00	11.83	0.00					19.59	20.22	19.34	18.28	17.92
Acacie	84.998	A TR 200	17.49	0.40	17.11	0.40		7.74	0.18	0.09	18.14	18.63	18.31	18.42	18.32
Acacie	84.998	A TR 30	11.83	0.00	12.09	0.00					18.14	17.96	17.42	17.17	16.97
Acacie	84.997	A TR 200	17.49	0.00	17.11	0.00					18.35	18.63	18.31	18.42	18.32
Acacie	84.997	A TR 30	11.83	0.00	12.09	0.00					18.35	17.96	17.42	17.17	16.97
Acacie	82.998	A TR 200	17.10	0.15	17.00	0.15		1.28	0.31	0.15	16.65	17.36	16.79	17.22	16.96
Acacie	82.998	A TR 30	12.09	0.00	12.13	0.00					16.65	16.89	16.38	16.70	16.45
Acacie	82.997	A TR 200	17.10	0.00	17.00	0.00					17.09	17.36	16.79	17.22	16.96
Acacie	82.997	A TR 30	12.09	0.00	12.13	0.00					17.09	16.89	16.38	16.70	16.45
Acacie	80.98	A TR 200	17.00	0.00	17.07	0.00					16.76	16.47	15.51	15.83	15.27
Acacie	80.98	A TR 30	12.13	0.00	12.18	0.00					16.76	16.03	15.19	15.39	14.96
Acacie	80.97	A TR 200	17.00	0.00	17.07	0.00					16.76	16.47	15.51	15.83	15.27
Acacie	80.97	A TR 30	12.13	0.00	12.18	0.00					16.76	16.03	15.19	15.39	14.96
Acacie	76.98	A TR 200	18.44	0.68	16.49	0.68		4.80	0.44	0.24	2.04	3.71	3.25	3.45	2.48
Acacie	76.98	A TR 30	12.89	0.00	13.20	0.00					2.04	3.24	2.74	2.62	1.99
Acacie	76.97	A TR 200	18.44	1.74	16.49	1.74		5.24	0.55	0.32	1.93	3.71	3.25	3.45	2.48
Acacie	76.97	A TR 30	12.89	0.01	13.20	0.01		0.49	0.06	0.03	1.93	3.24	2.74	2.62	1.99
Acacie	74.98	A TR 200	16.58	0.47	16.27	0.47		7.20	0.14	0.11	1.68	2.78	1.99	2.39	1.82
Acacie	74.98	A TR 30	13.27	0.00	13.27	0.00		0.23	0.00	0.00	1.68	2.32	1.76	2.14	1.68
Acacie	74.97	A TR 200	16.58	0.00	16.27	0.00		0.48	0.04	0.02	1.95	2.78	1.99	2.39	1.82
Acacie	74.97	A TR 30	13.27	0.00	13.27	0.00					1.95	2.32	1.76	2.14	1.68
Acacie	73.38	A TR 200	16.21	6.62	3.64	6.62		27.42	0.44	0.27	1.25	2.35	1.72	1.66	1.63
Acacie	73.38	A TR 30	13.27	4.98	3.36	4.98		27.16	0.32	0.22	1.25	2.10	1.56	1.60	1.57
Acacie	73.37	A TR 200	16.21	6.50	3.64	6.50		26.90	0.44	0.27	1.25	2.35	1.72	1.66	1.63
Acacie	73.37	A TR 30	13.27	4.93	3.36	4.93		26.78	0.32	0.22	1.25	2.10	1.56	1.60	1.57

Botro Grande e botro Condotti

Stato attuale

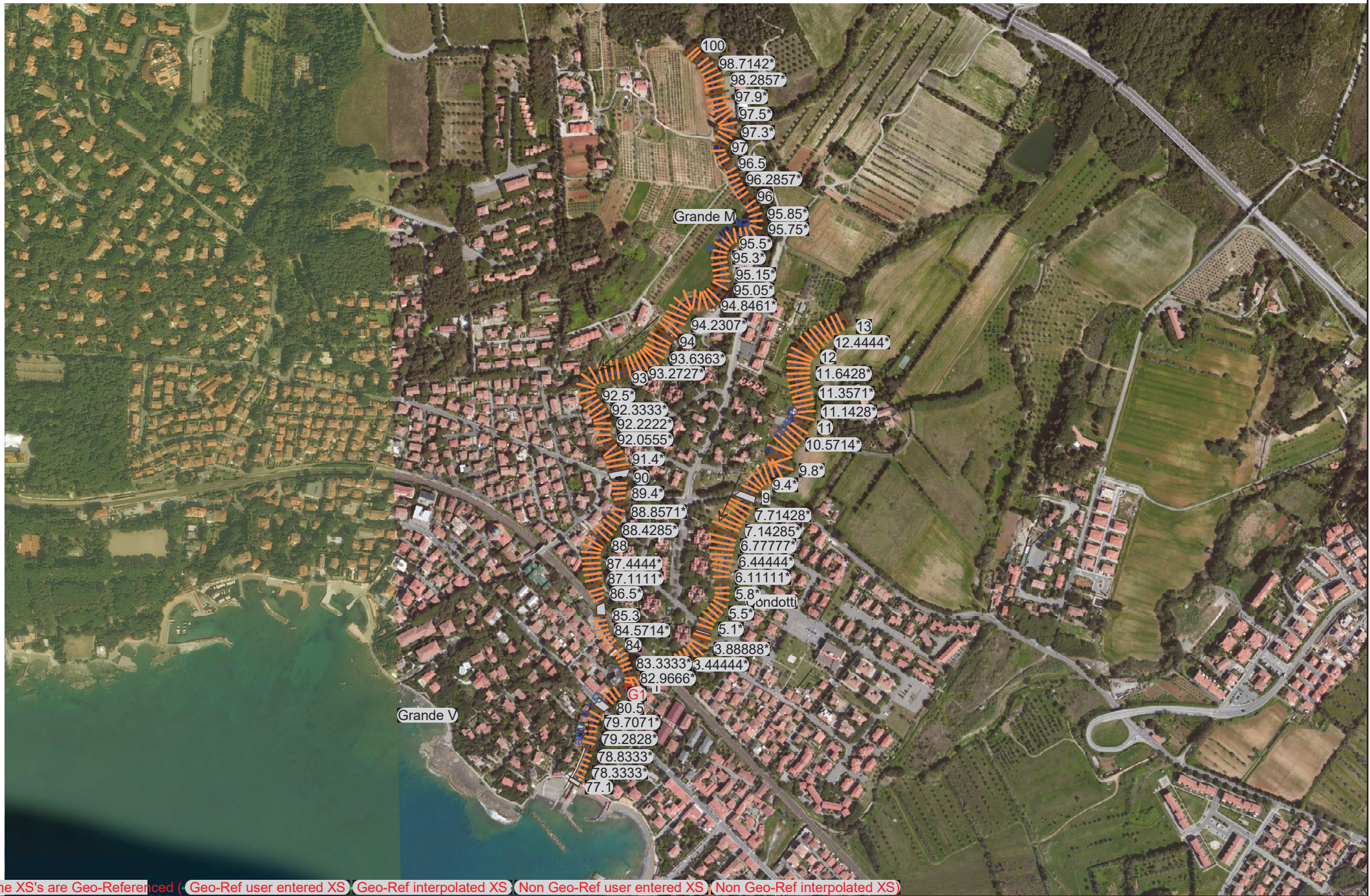

None of the XS's are Geo-Referenced (Geo-Ref user entered XS, Geo-Ref interpolated XS, Non Geo-Ref user entered XS, Non Geo-Ref interpolated XS)

1 cm Horiz. = 82 m 1 cm Vert. = 67 m

1) A TR200 2) A TR30

← Grande Grande V →

Grande Grande M →

N.B. in grigio sono indicati gli sfioratori laterali in destra idrografica

Legend

- WS Max WS - A TR200
- WS Max WS - A TR30
- Ground

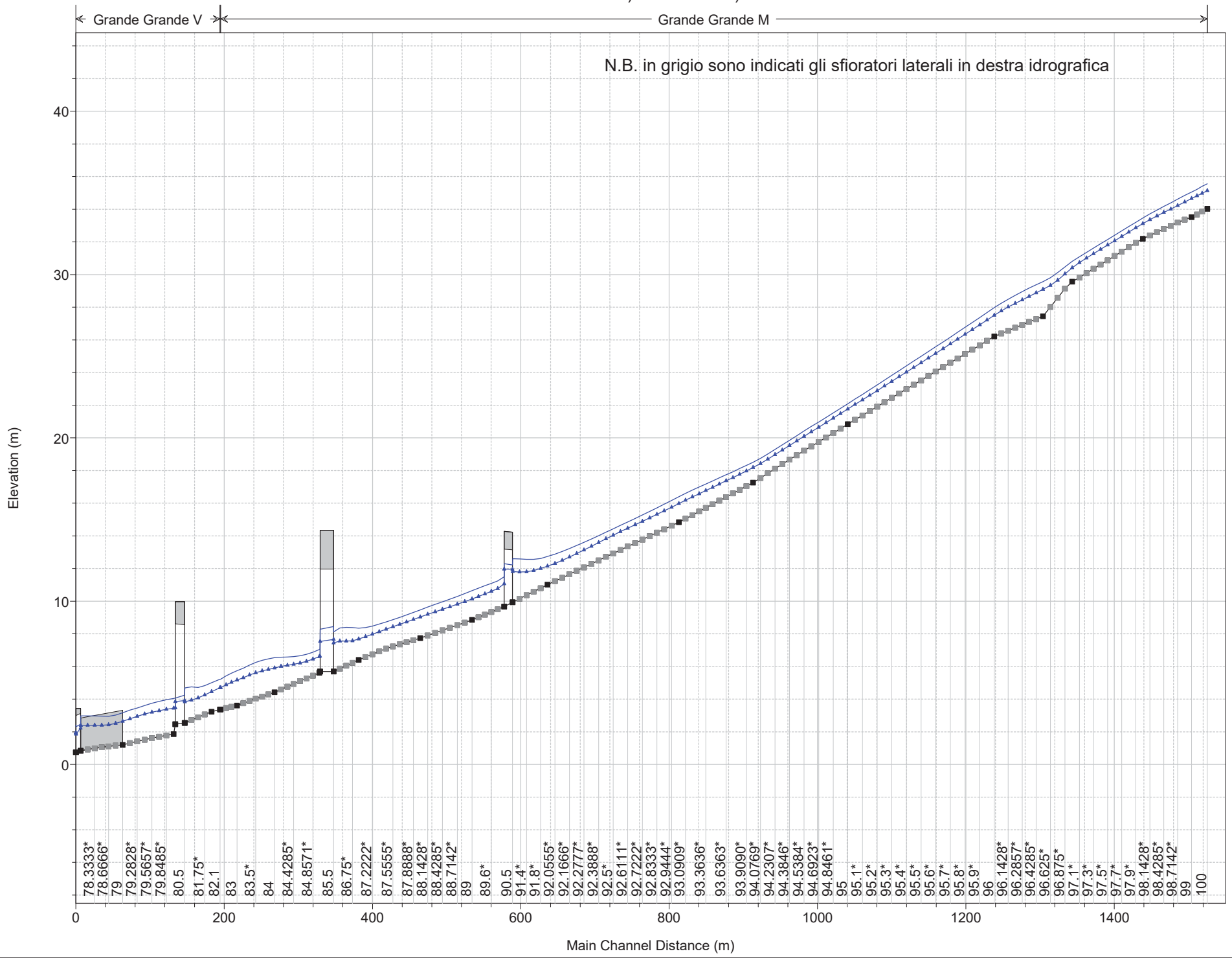

1 cm Horiz. = 66 m 1 cm Vert. = 3 m

1) A TR200 2) A TR30

← Grande Grande V →

Grande Grande M

N.B. in grigio sono indicati gli sfioratori laterali in sinistra idrografica

Legend

- WS Max WS - A TR200
- WS Max WS - A TR30
- Ground

Elevation (m)

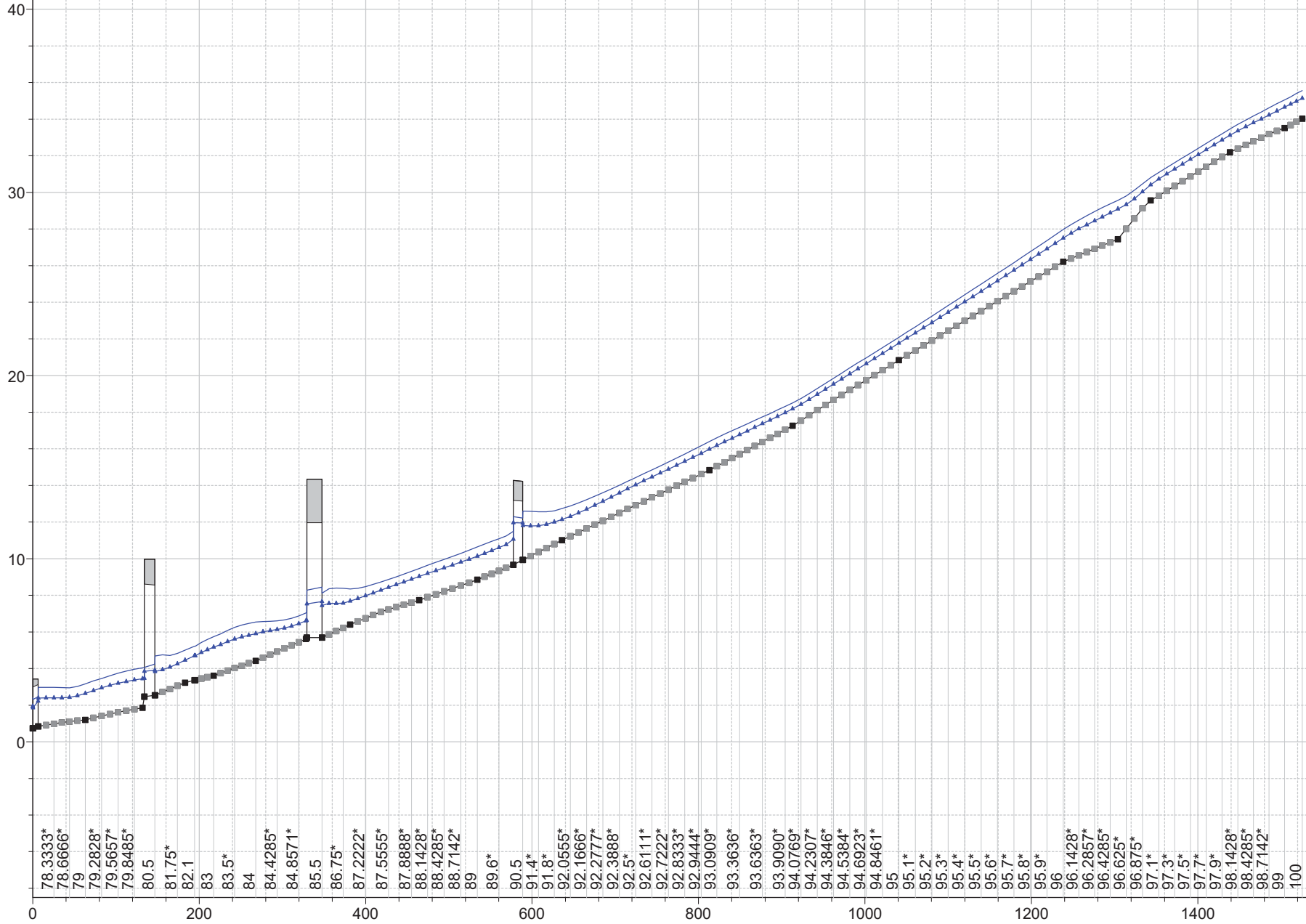

78.333*
78.6666*
79
79.2828*
79.5657*
79.8485*
80.5
81.75*
82.1
83
83.5*
84
84.4285*
84.8571*
85.5
86.75*
87.2222*
87.5555*
87.8888*
88.1428*
88.4285*
88.7142*
89
89.6*
90.5
91.4*
91.8*
92.0555*
92.1666*
92.2777*
92.3888*
92.5*
92.6111*
92.7222*
92.8333*
92.9444*
93.0909*
93.3636*
93.6363*
93.9090*
94.0769*
94.2307*
94.3846*
94.5384*
94.6923*
94.8461*
95
95.1*
95.2*
95.3*
95.4*
95.5*
95.6*
95.7*
95.8*
95.9*
96
96.1428*
96.2857*
96.4285*
96.625*
96.875*
97.1*
97.3*
97.5*
97.7*
97.9*
98.1428*
98.4285*
98.7142*
99
100

Main Channel Distance (m)

1 cm Horiz. = 66 m 1 cm Vert. = 3 m

1) A TR200 2) A TR30

Grande Condotti

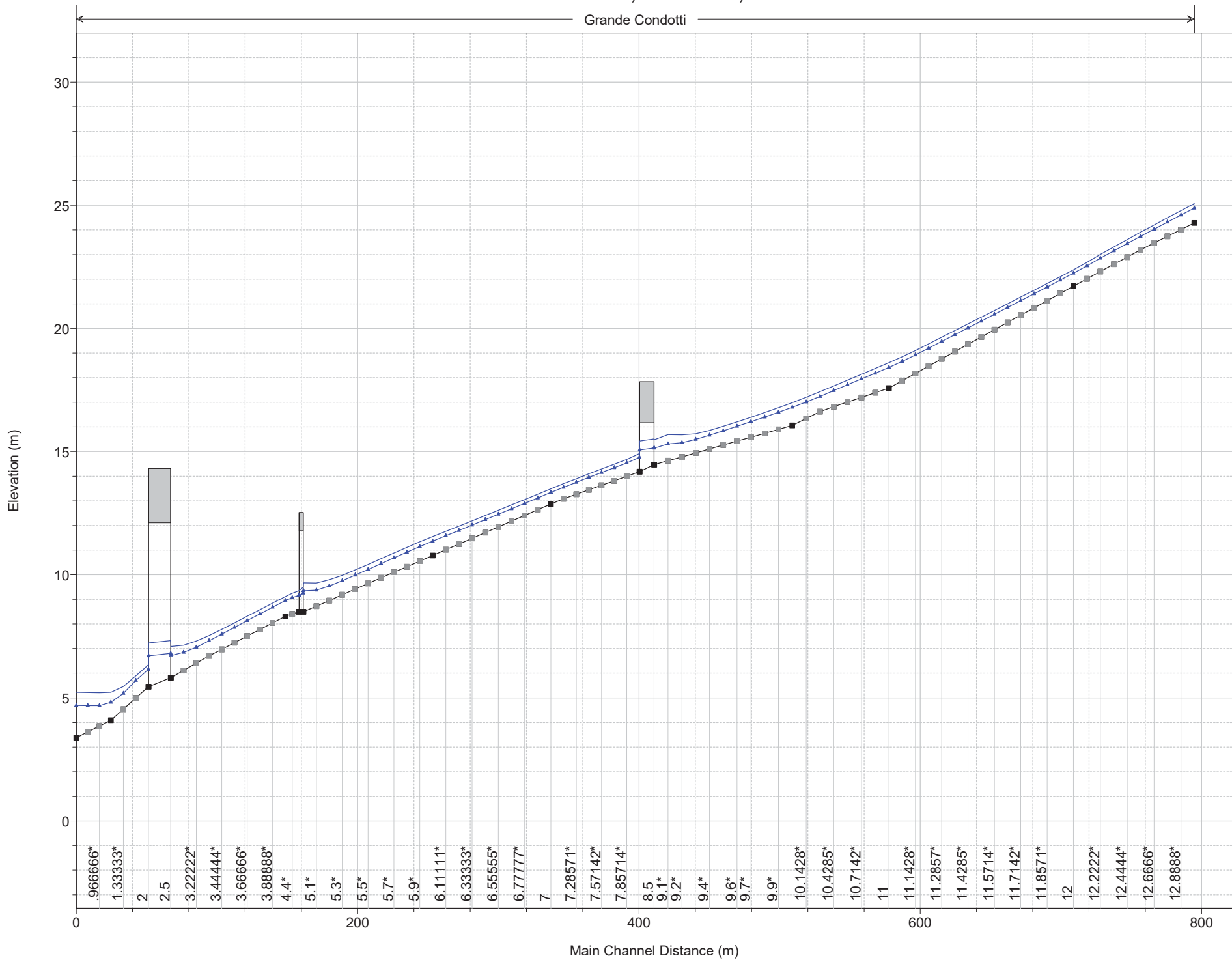

Legend

- WS Max WS - A TR200
- WS Max WS - A TR30
- Ground

1 cm Horiz. = 35 m 1 cm Vert. = 2 m

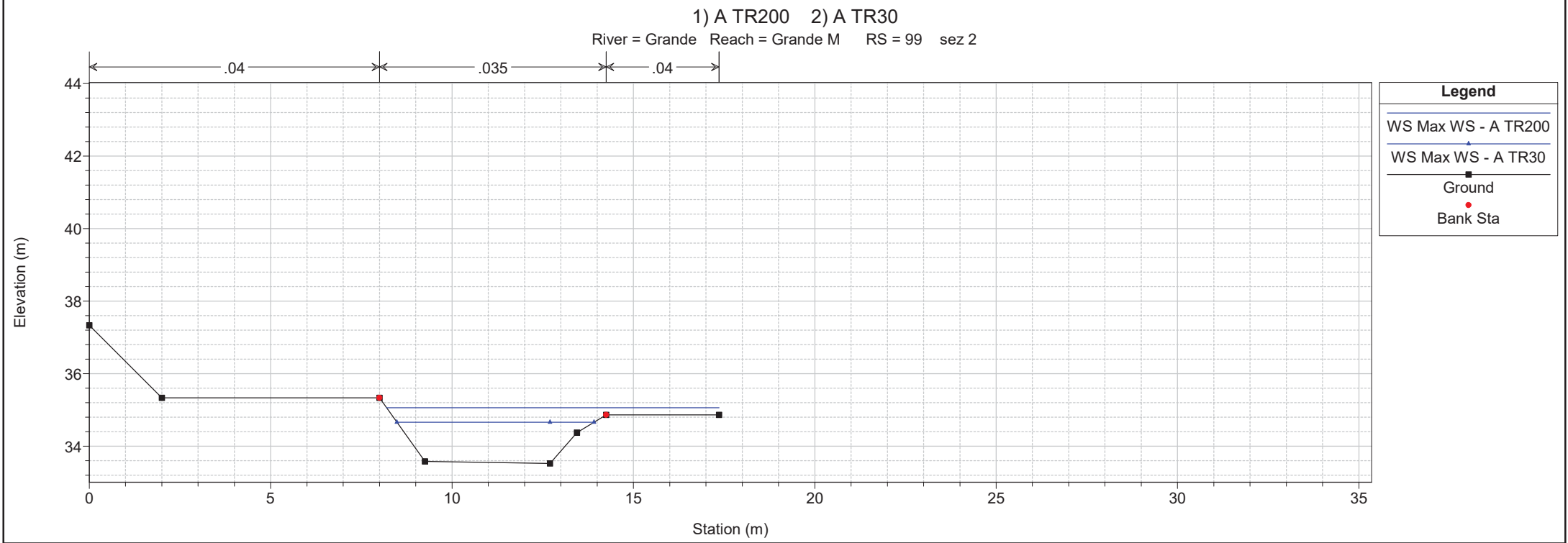
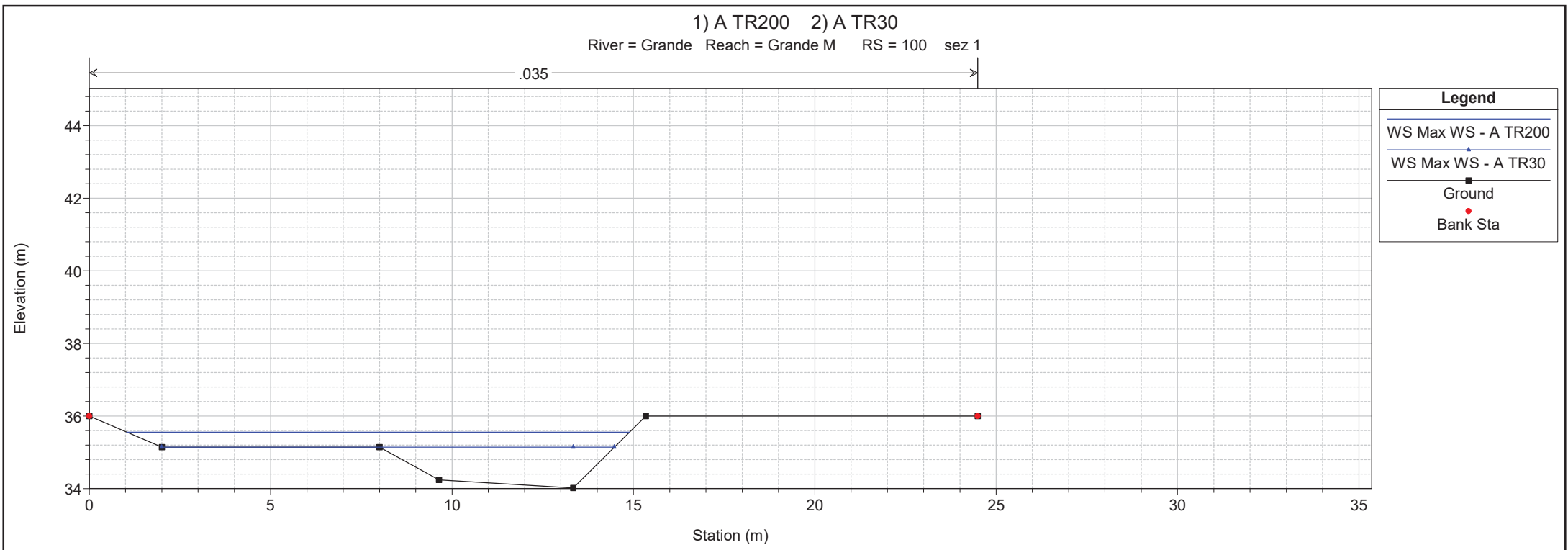

1 cm Horiz. = 1.5 m 1 cm Vert. = 1.5 m

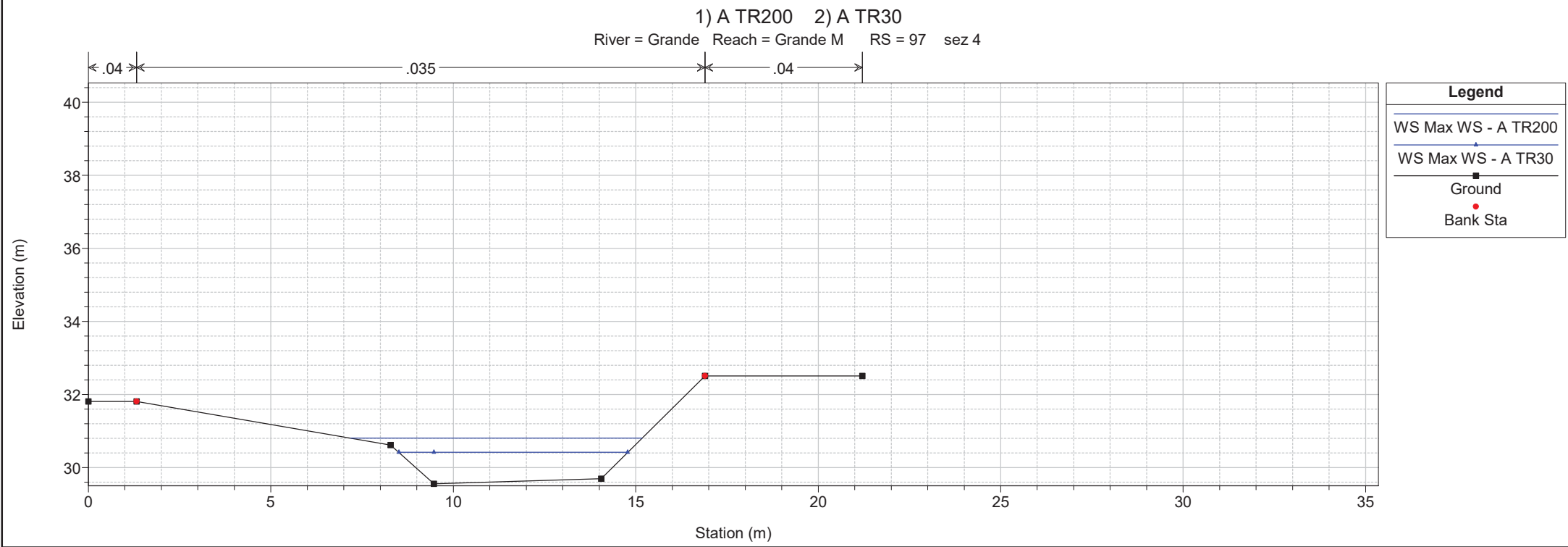
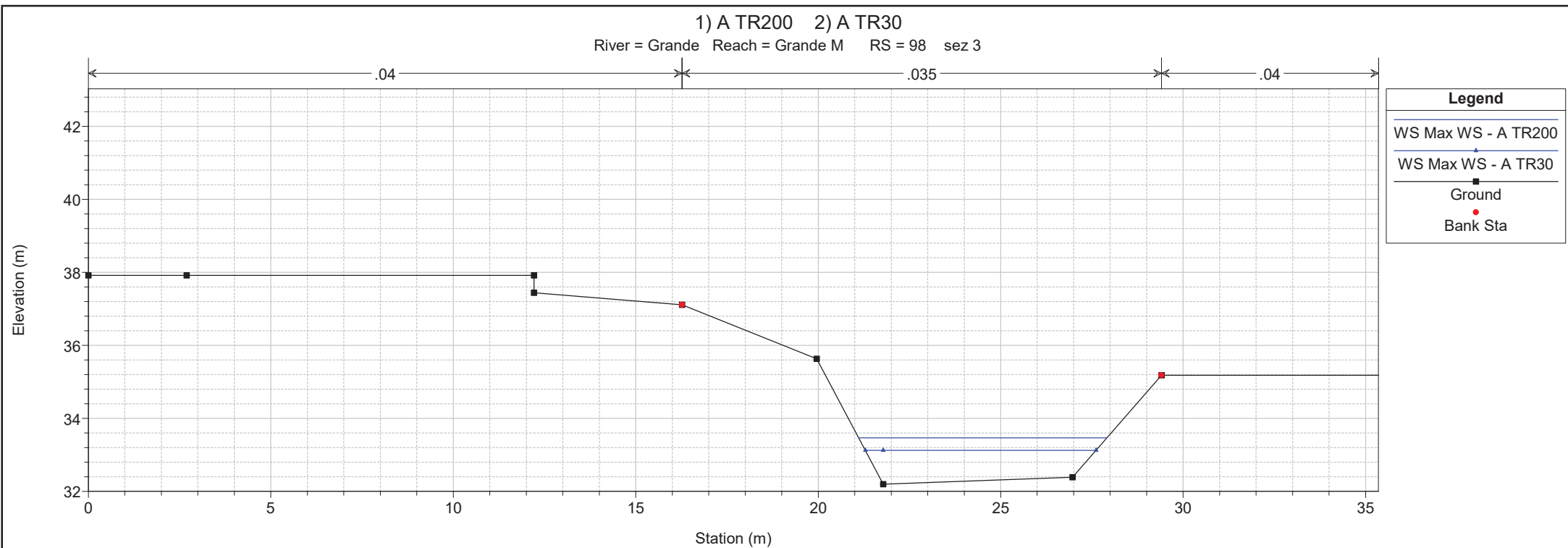

1 cm Horiz. = 1.5 m 1 cm Vert. = 1.5 m

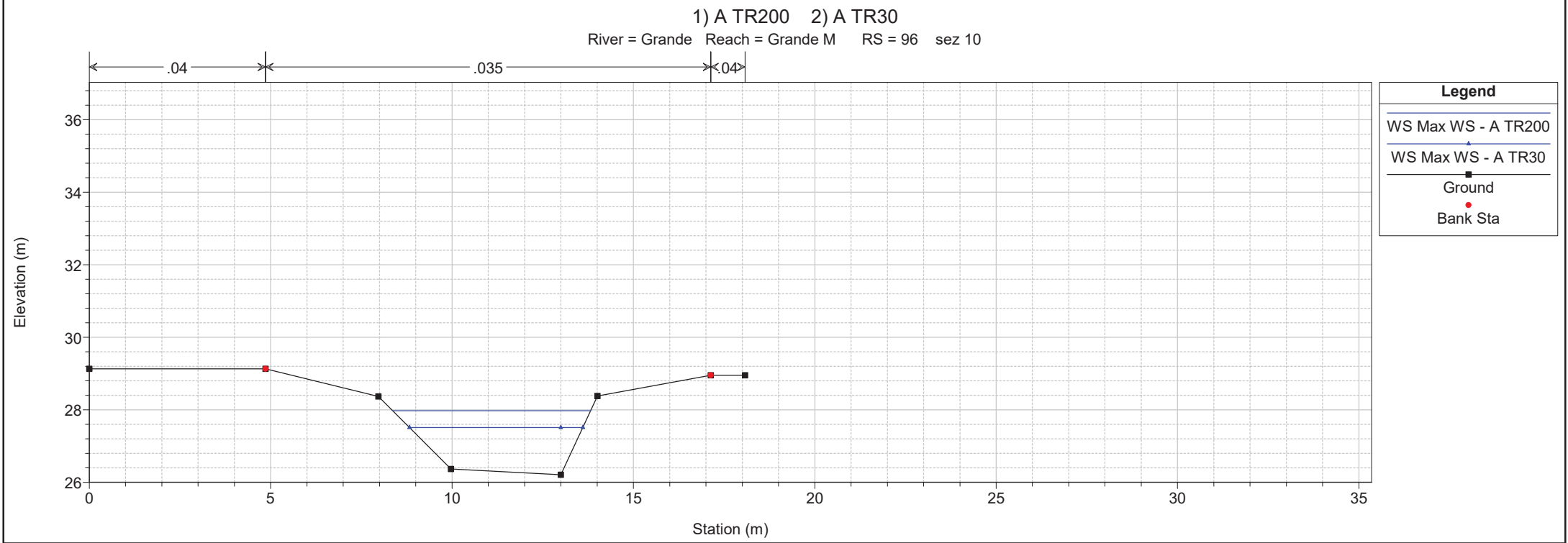
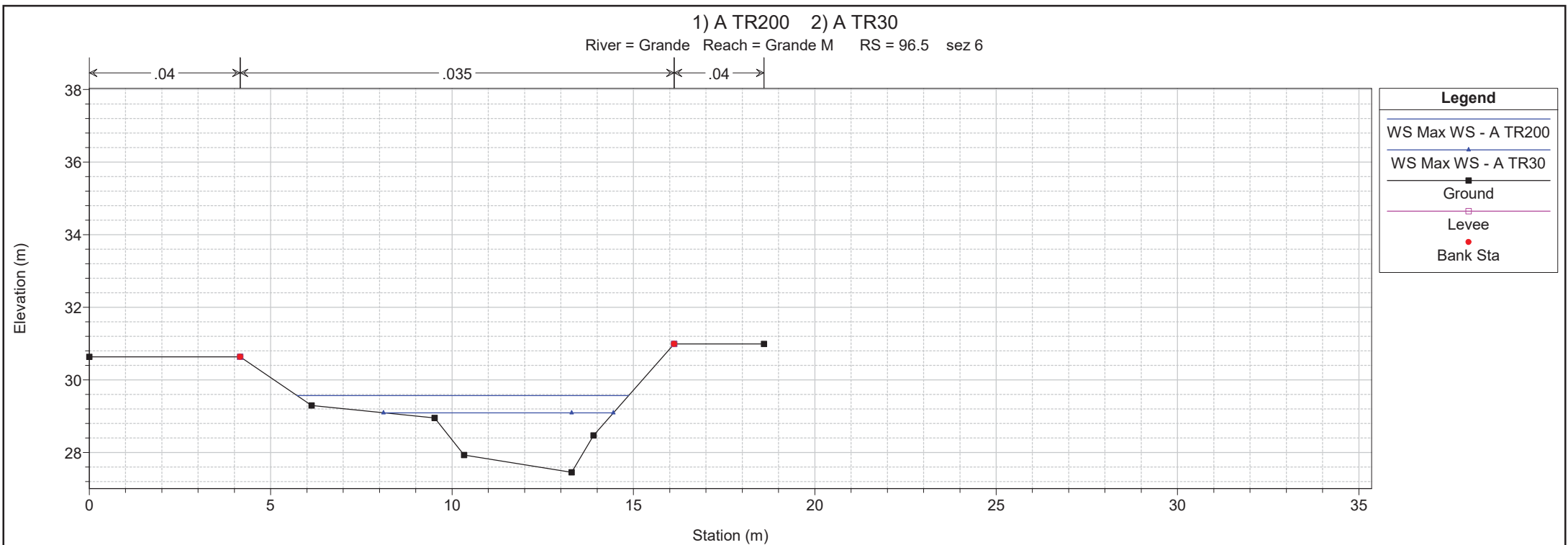

1 cm Horiz. = 1.5 m 1 cm Vert. = 1.5 m

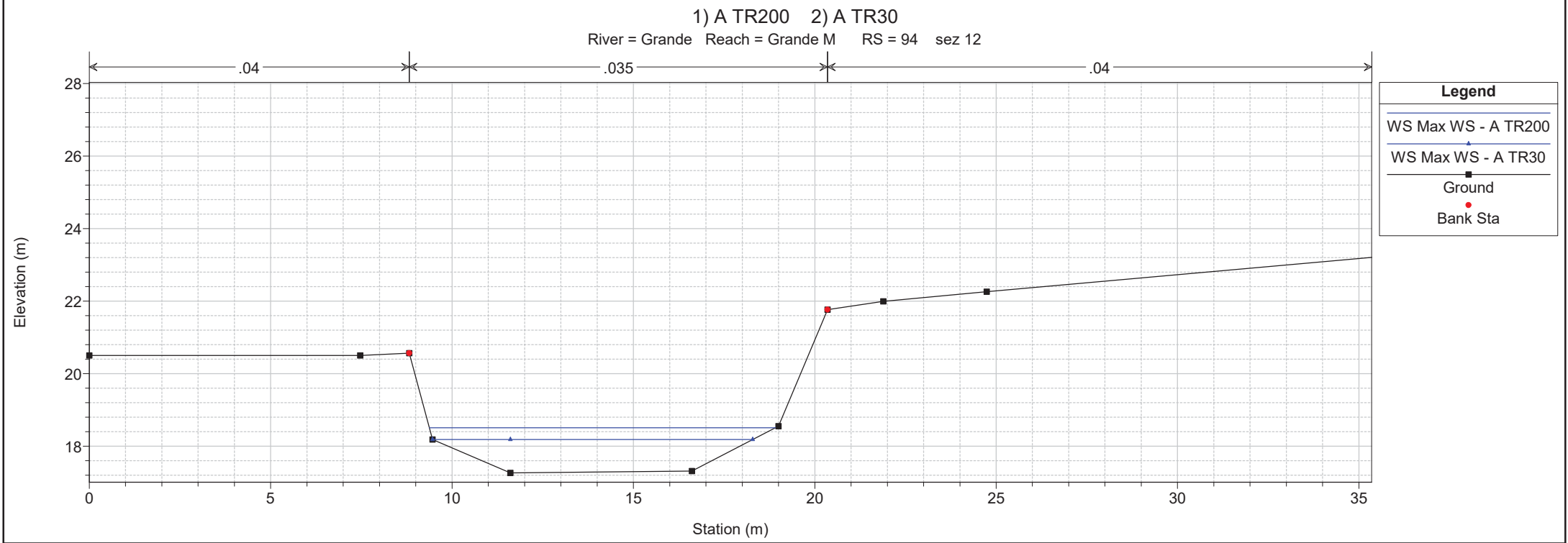
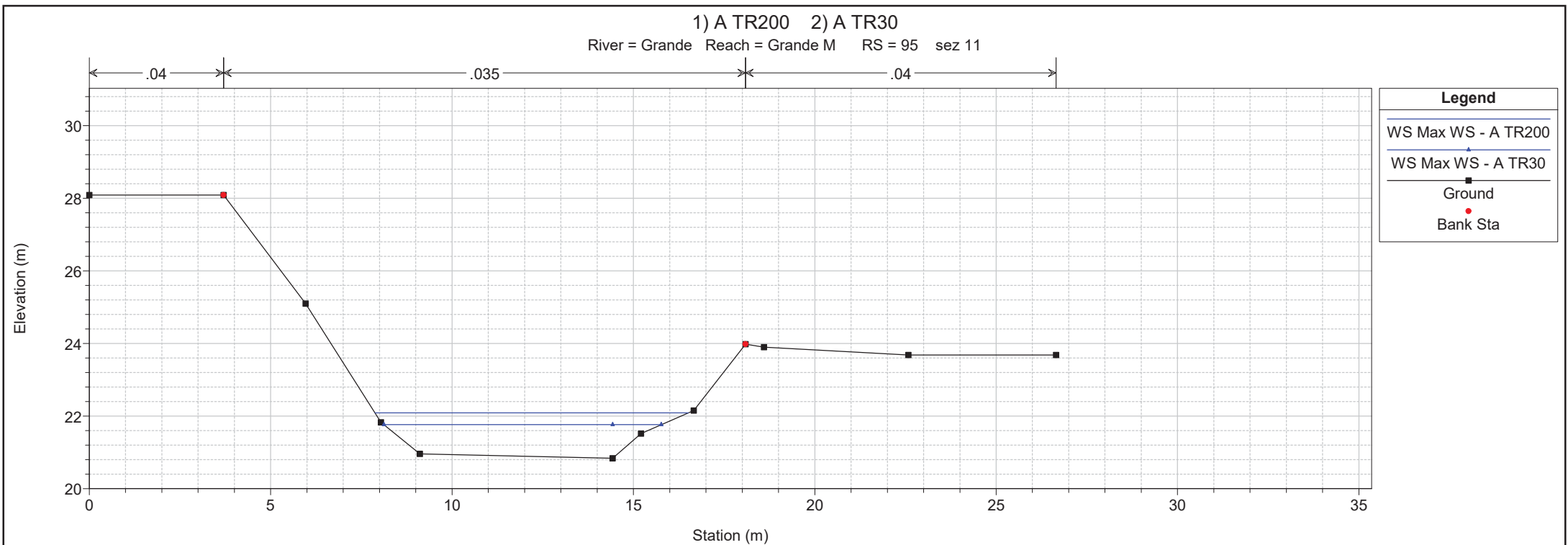

1 cm Horiz. = 1.5 m 1 cm Vert. = 1.5 m

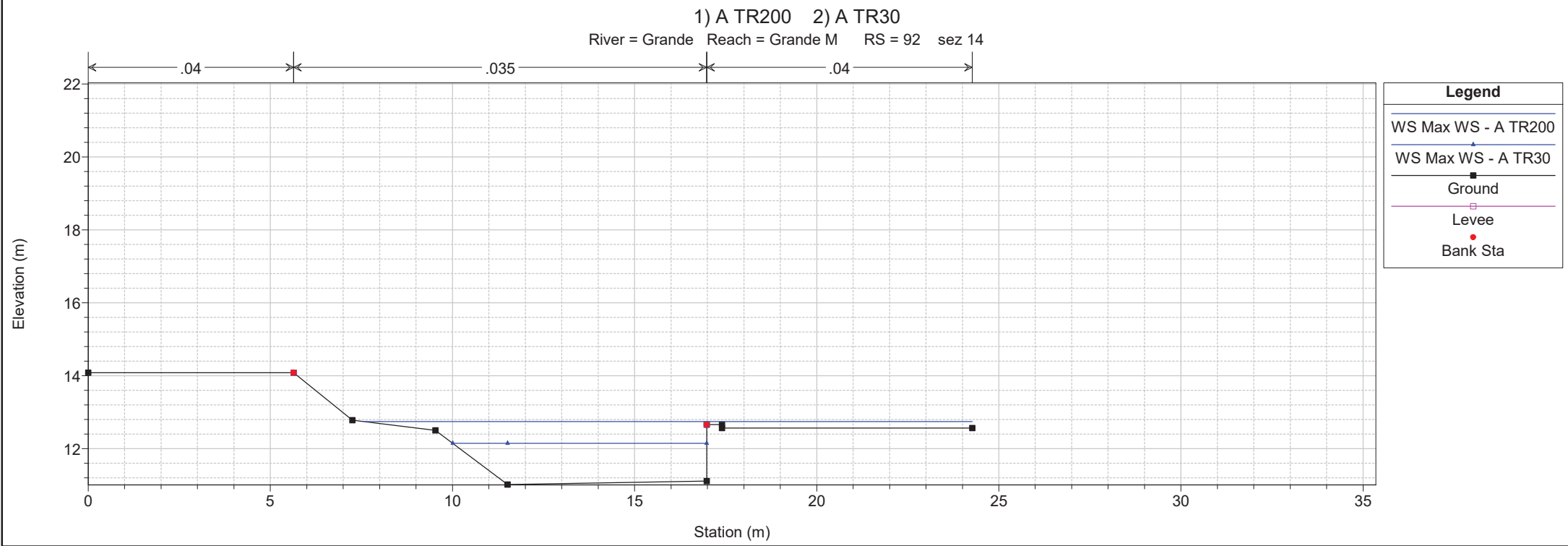
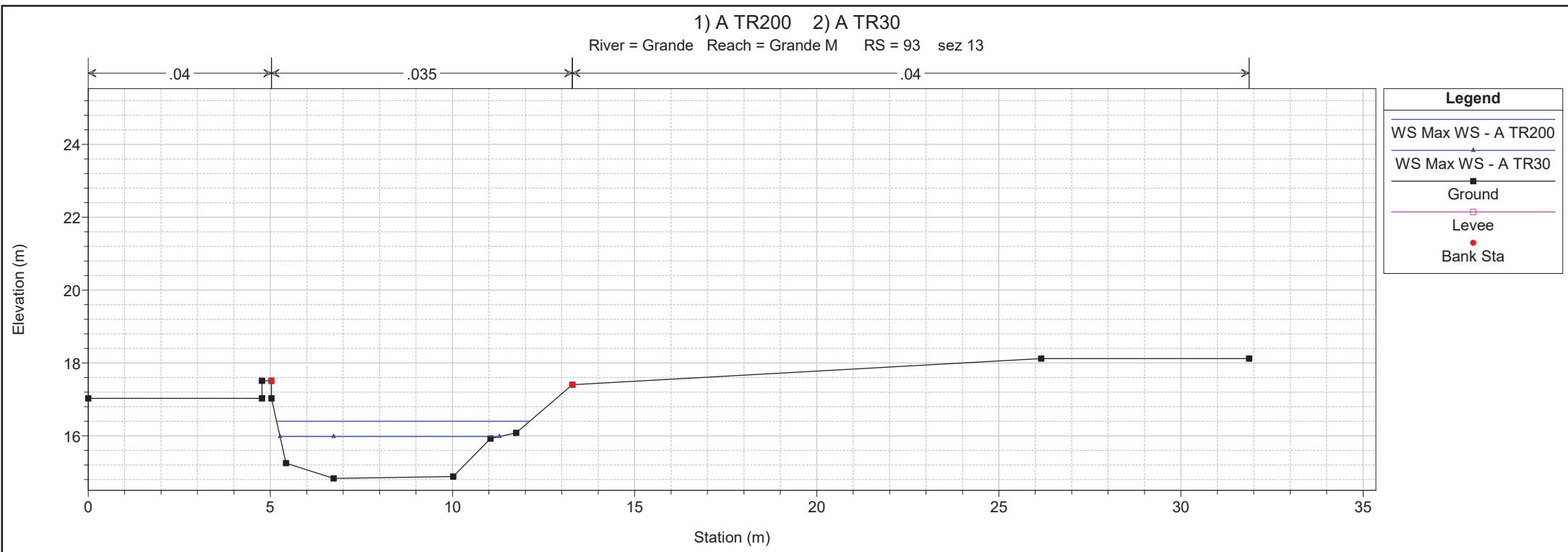

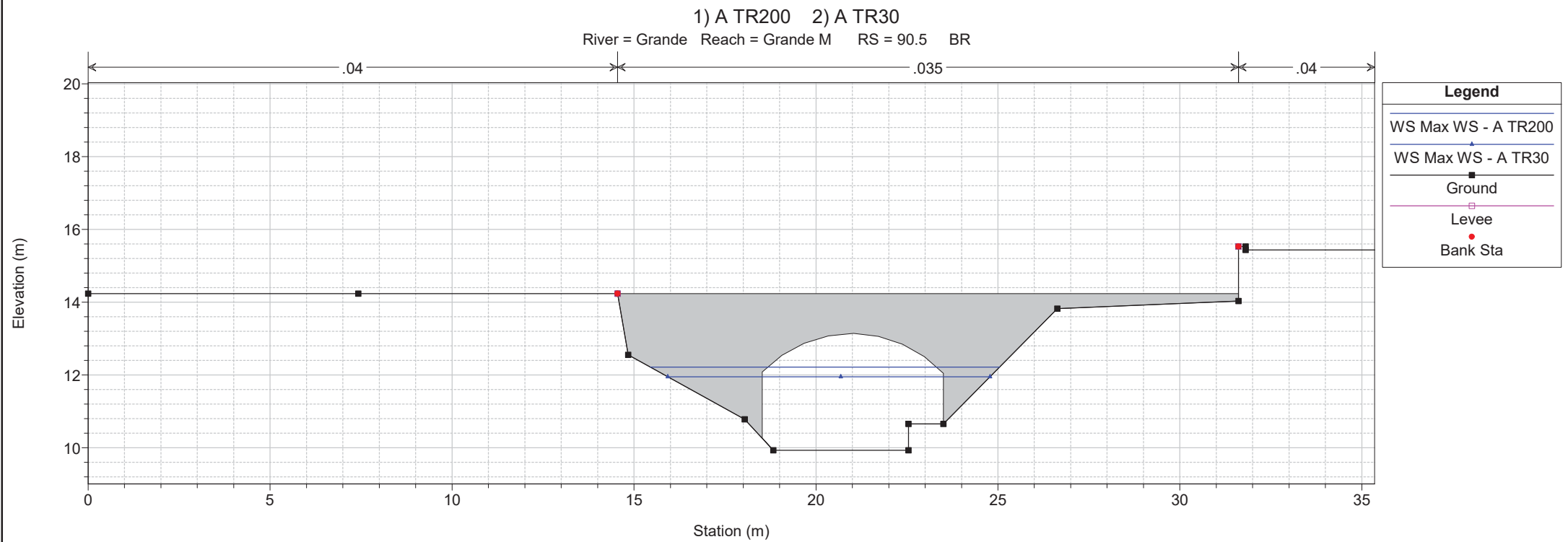
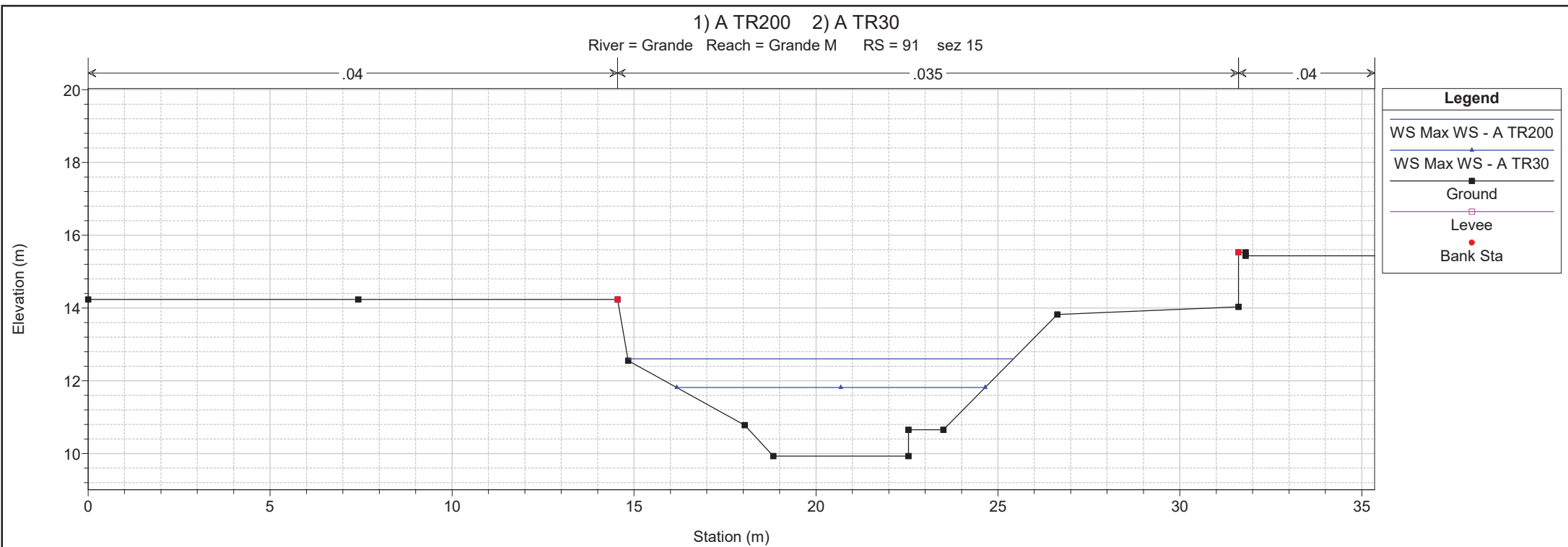

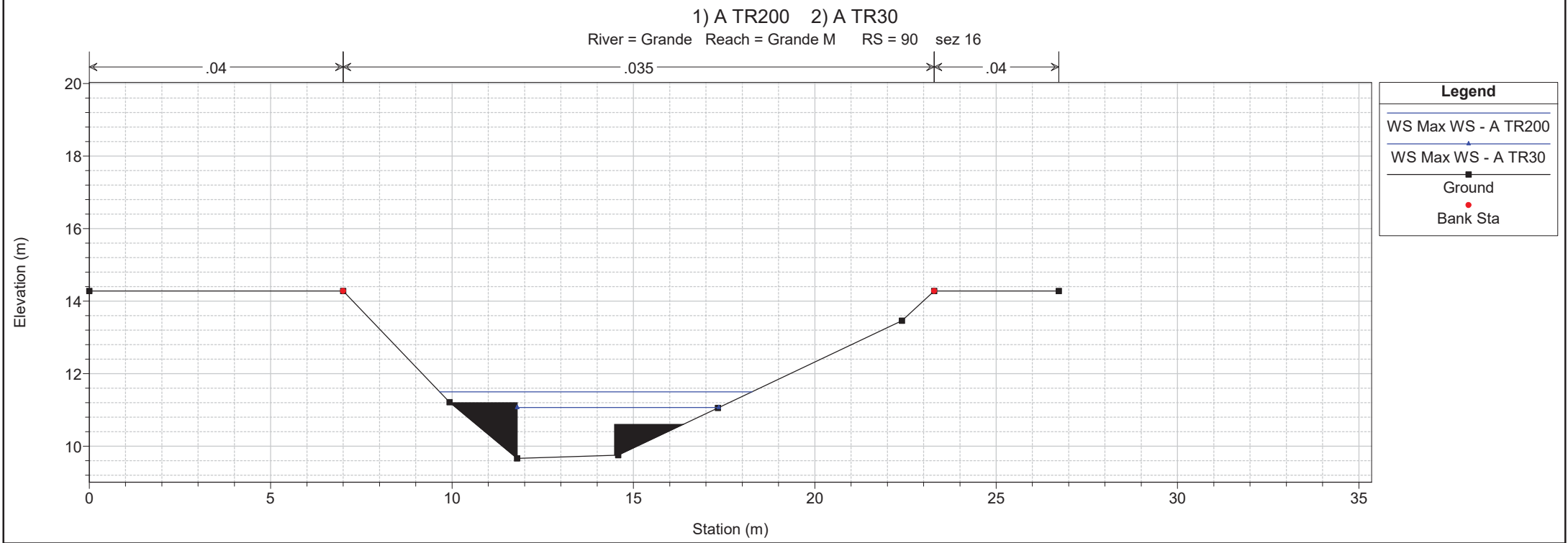
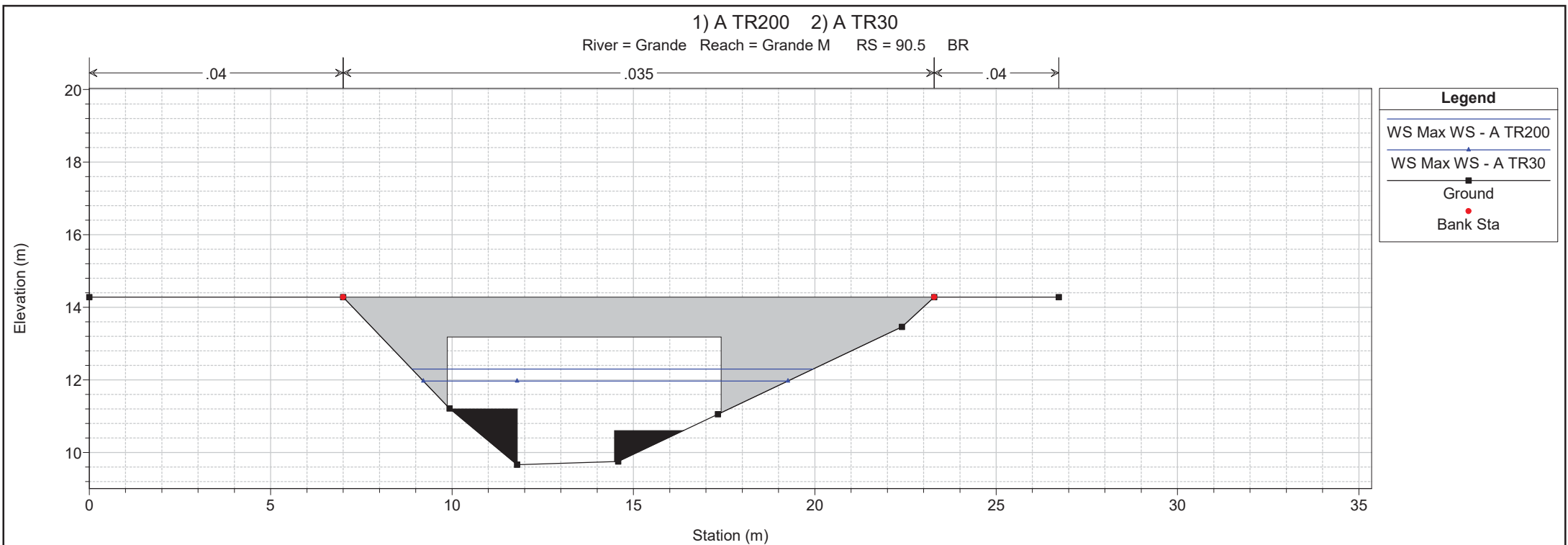

1 cm Horiz. = 1.5 m 1 cm Vert. = 1.5 m

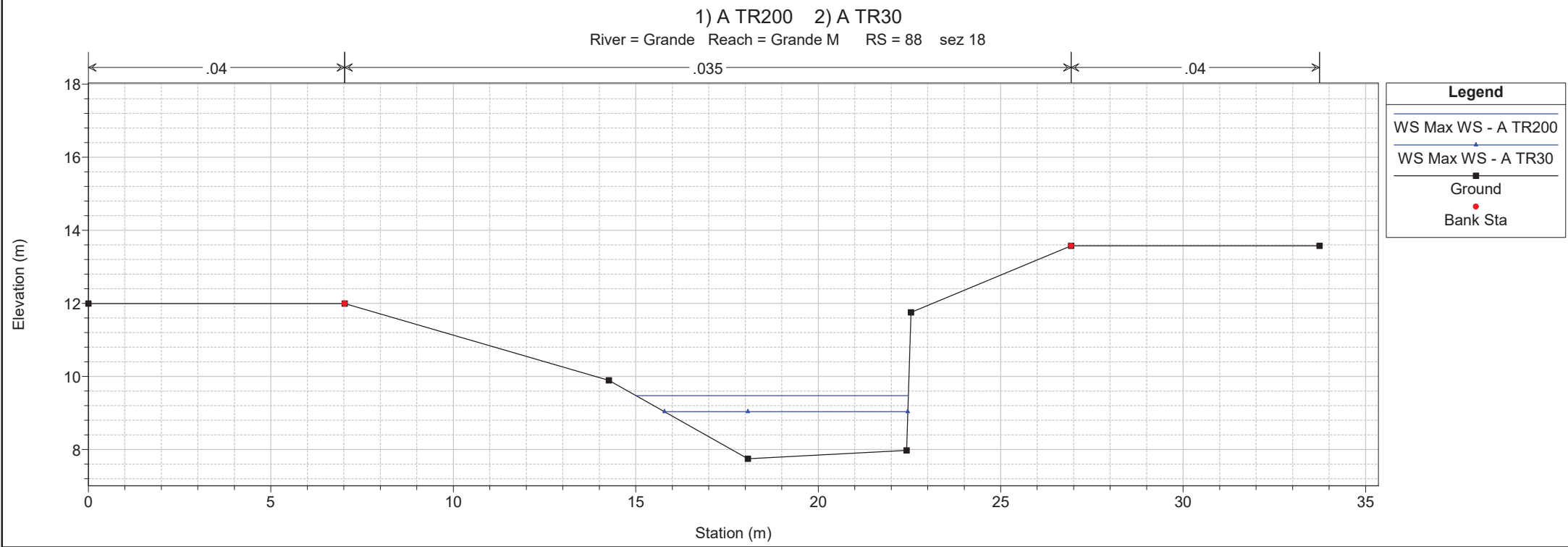
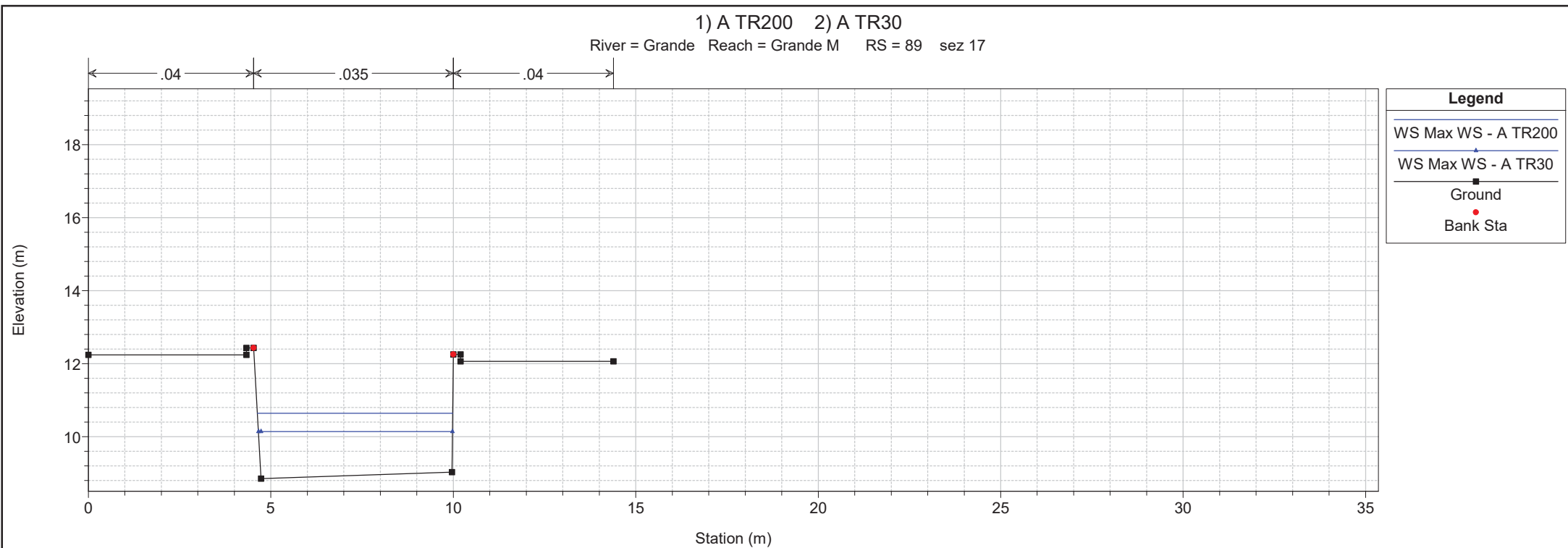

1 cm Horiz. = 1.5 m 1 cm Vert. = 1.5 m

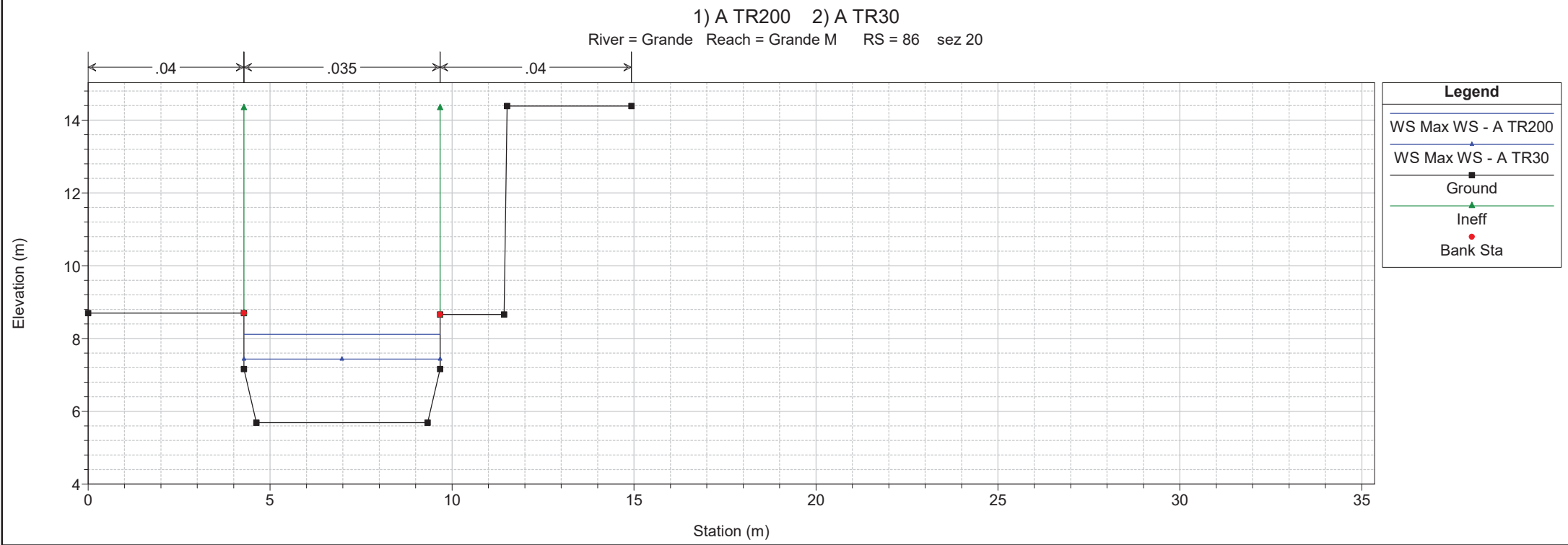
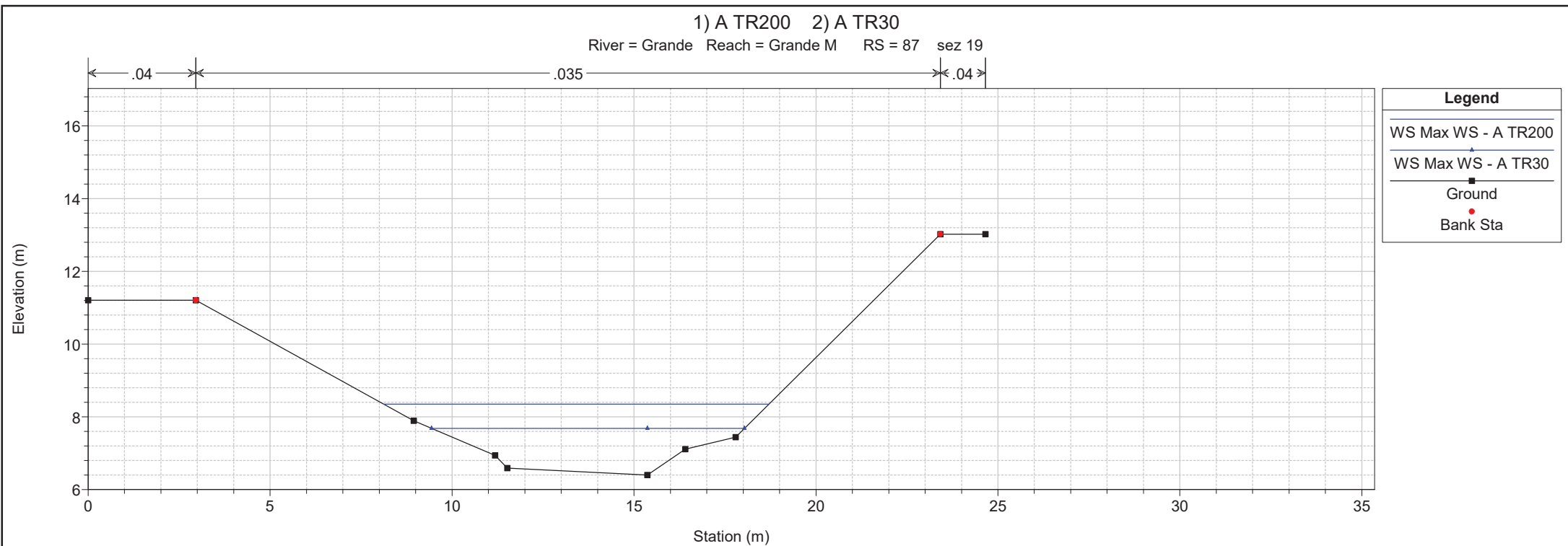

1 cm Horiz. = 1.5 m 1 cm Vert. = 1.5 m

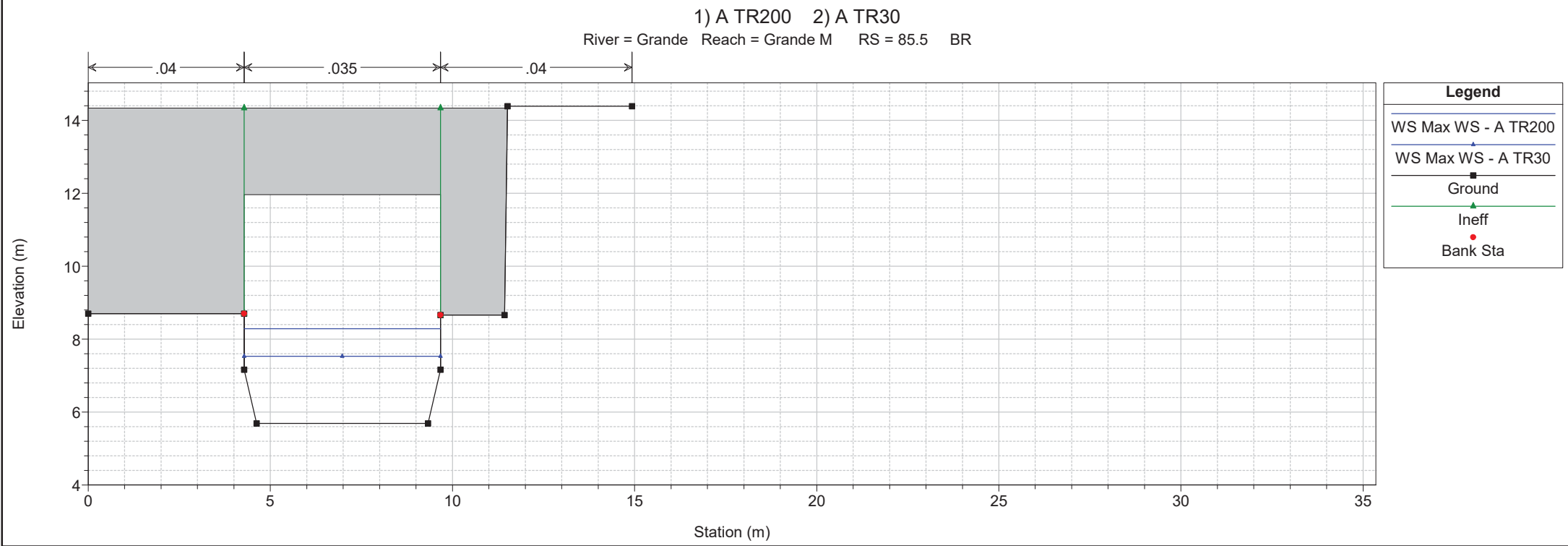
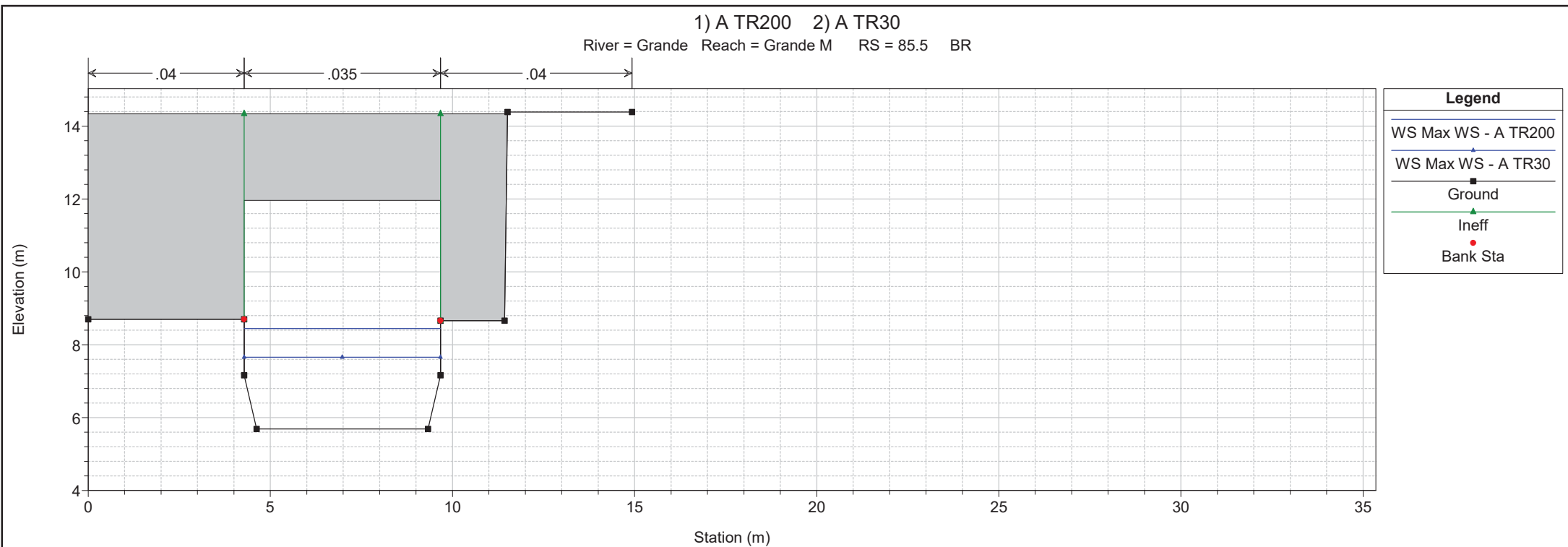

1 cm Horiz. = 1.5 m 1 cm Vert. = 1.5 m

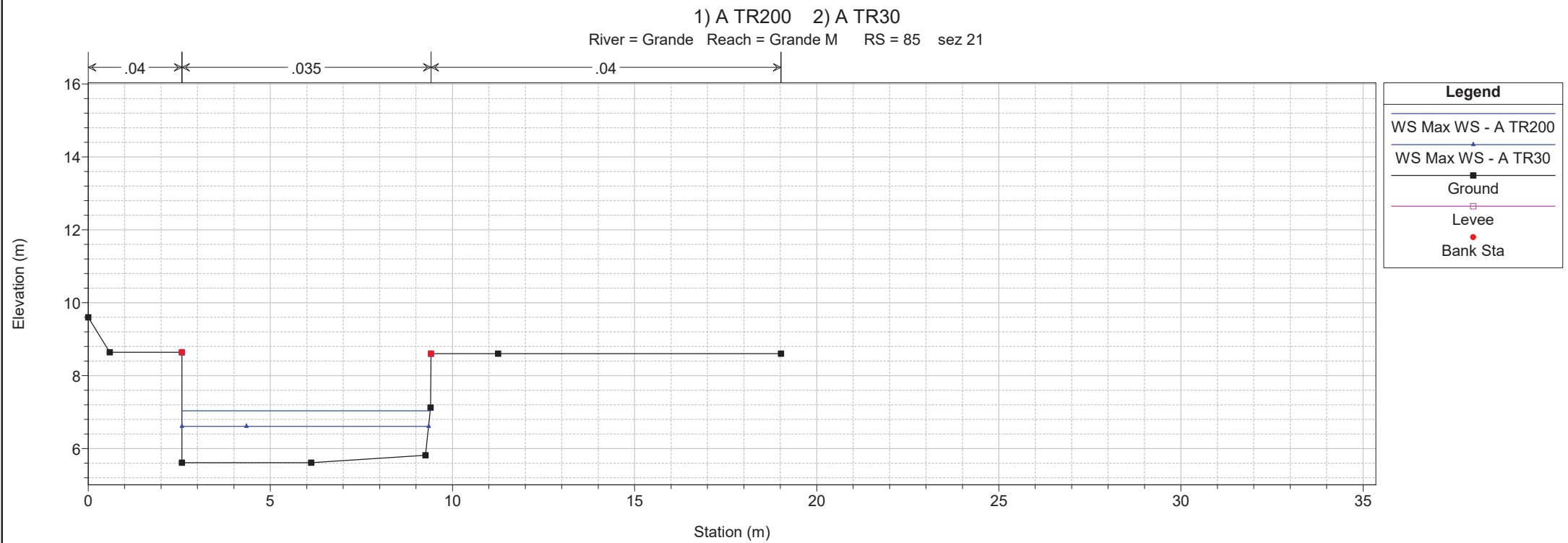
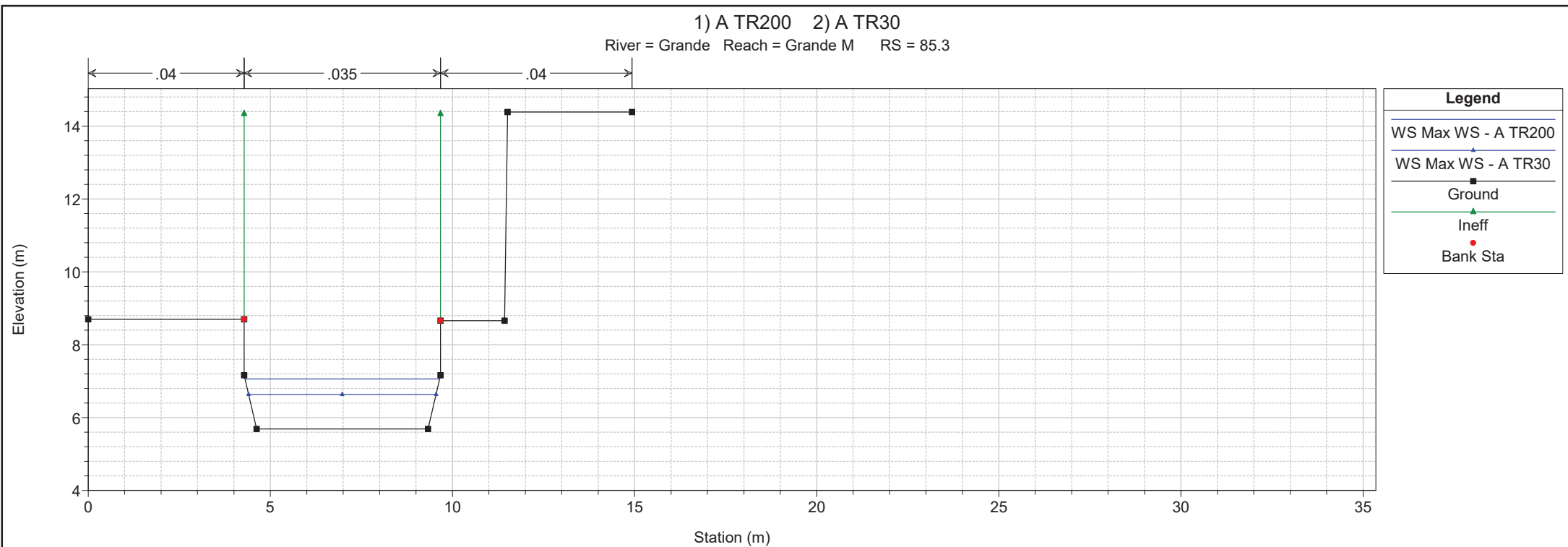

1 cm Horiz. = 1.5 m 1 cm Vert. = 1.5 m

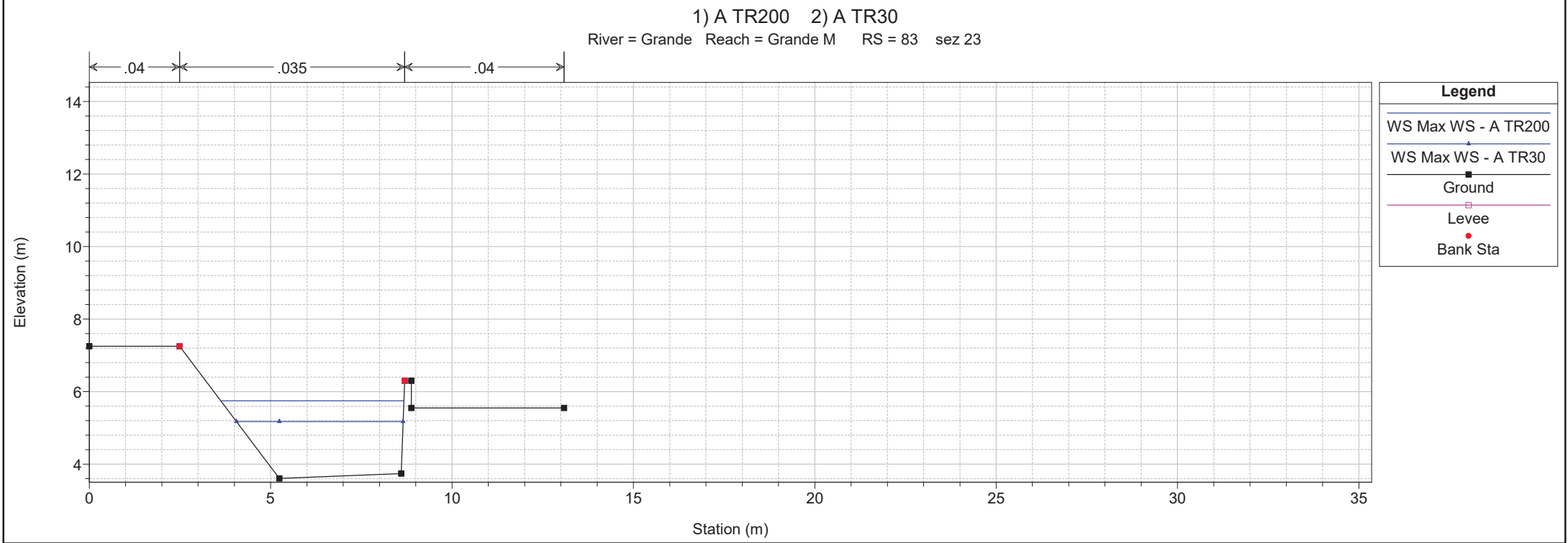
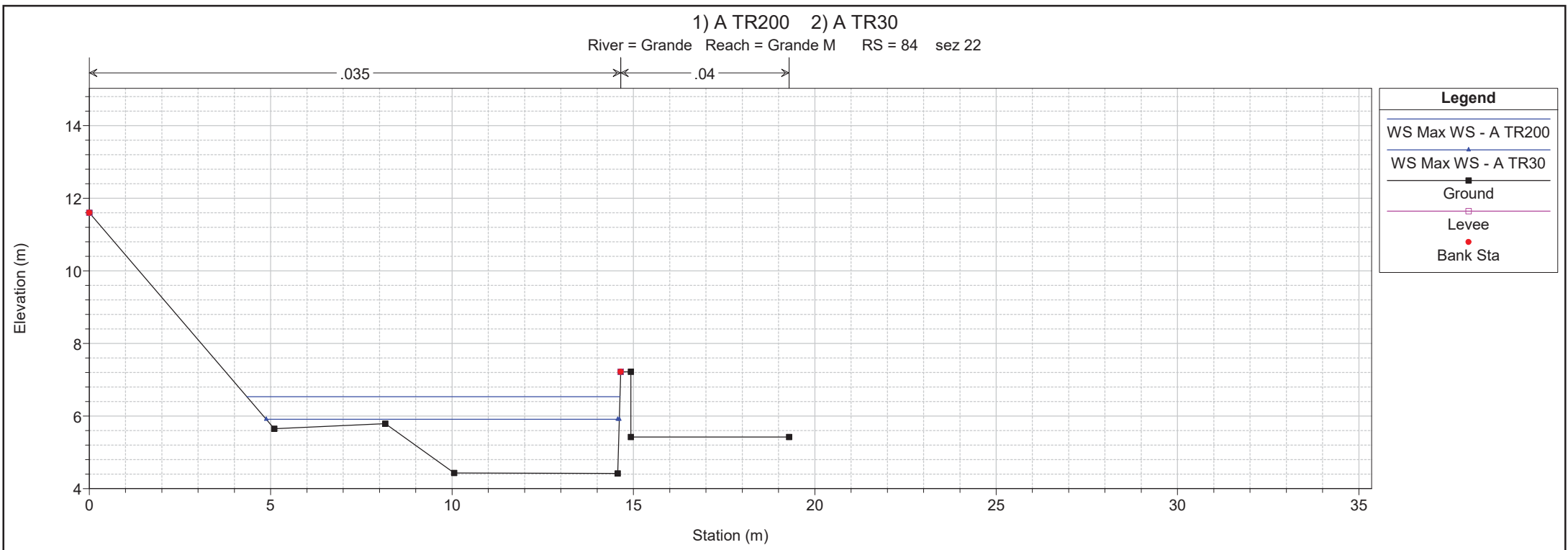

1 cm Horiz. = 1.5 m 1 cm Vert. = 1.5 m

1) A TR200 2) A TR30
 River = Grande Reach = Grande M RS = 82.9 sez 23

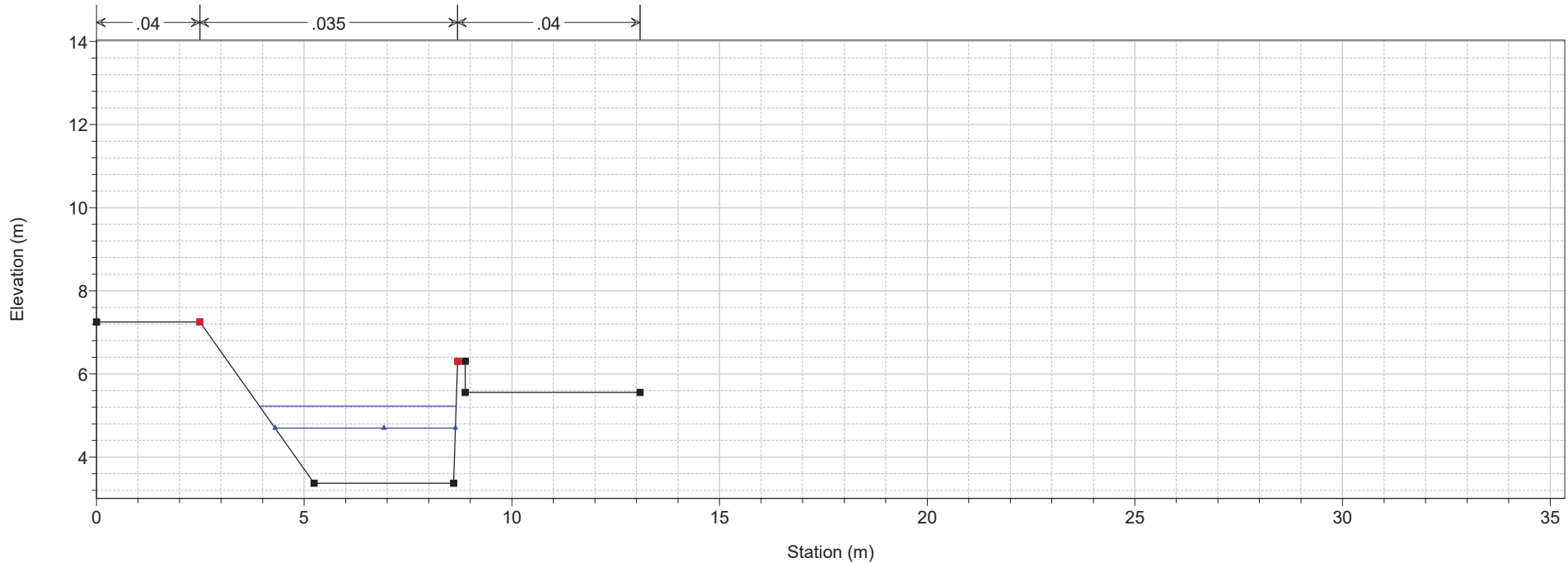

1) A TR200 2) A TR30
 River = Grande Reach = Grande V RS = 82.1 sez 24

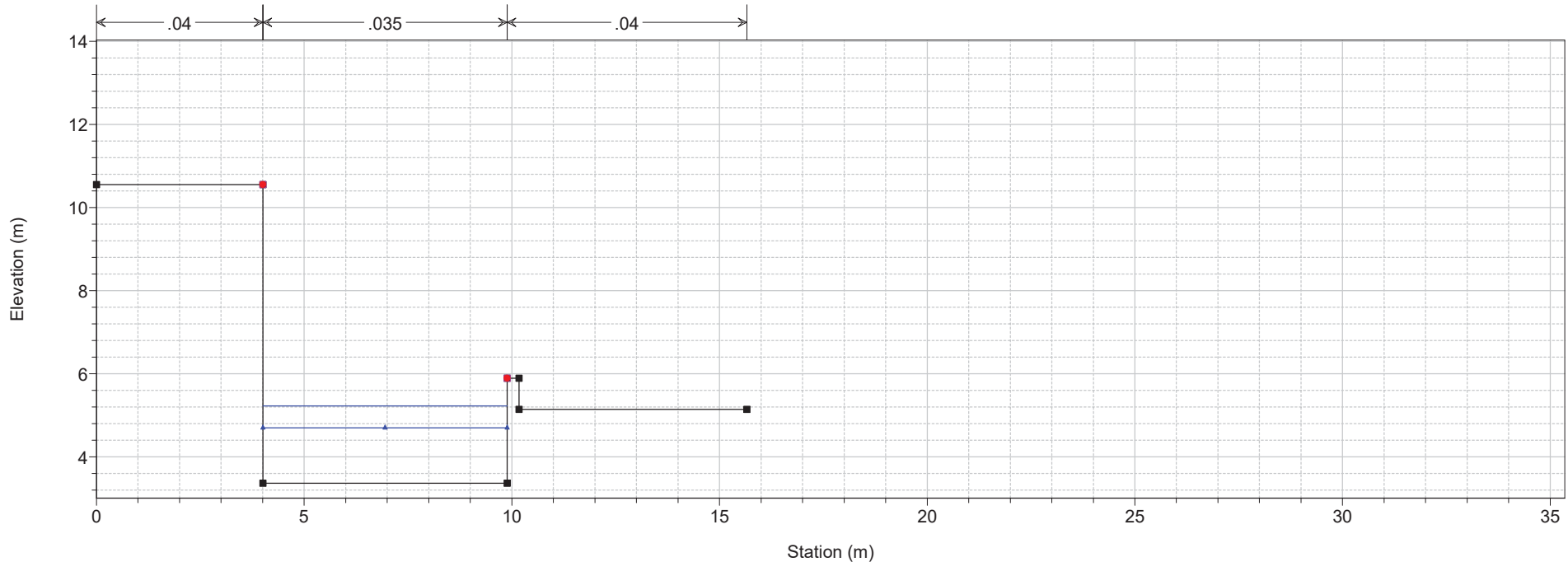

1 cm Horiz. = 1.5 m 1 cm Vert. = 1.5 m

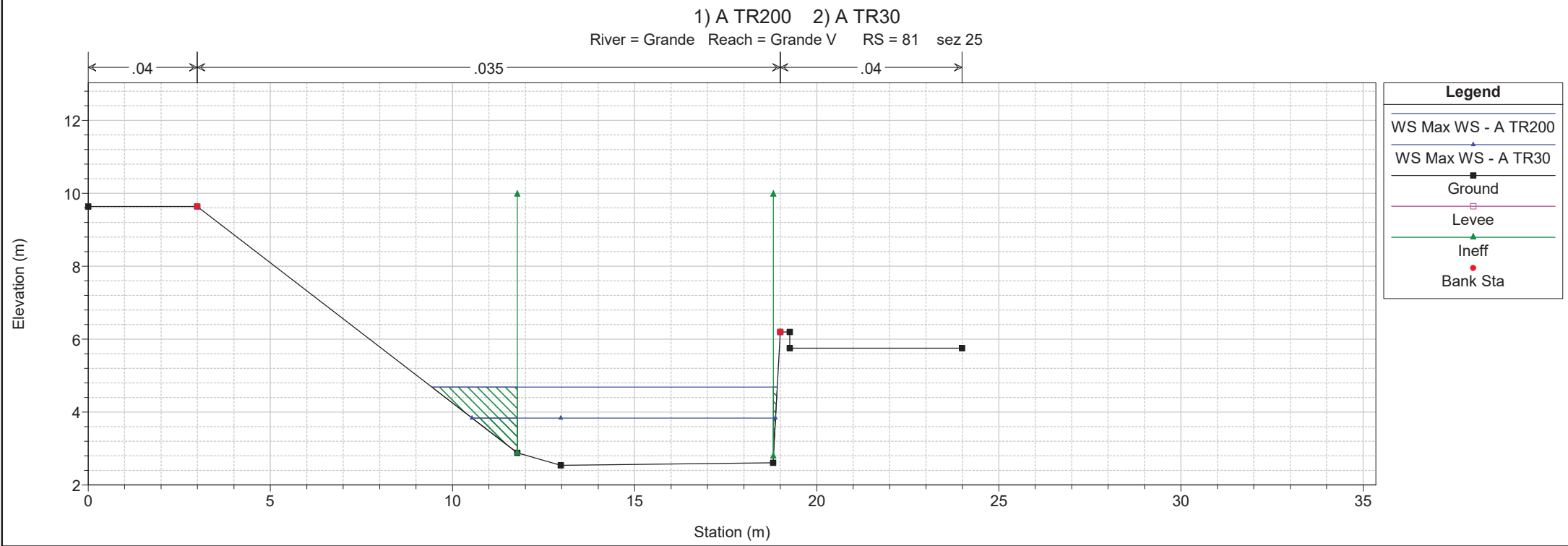
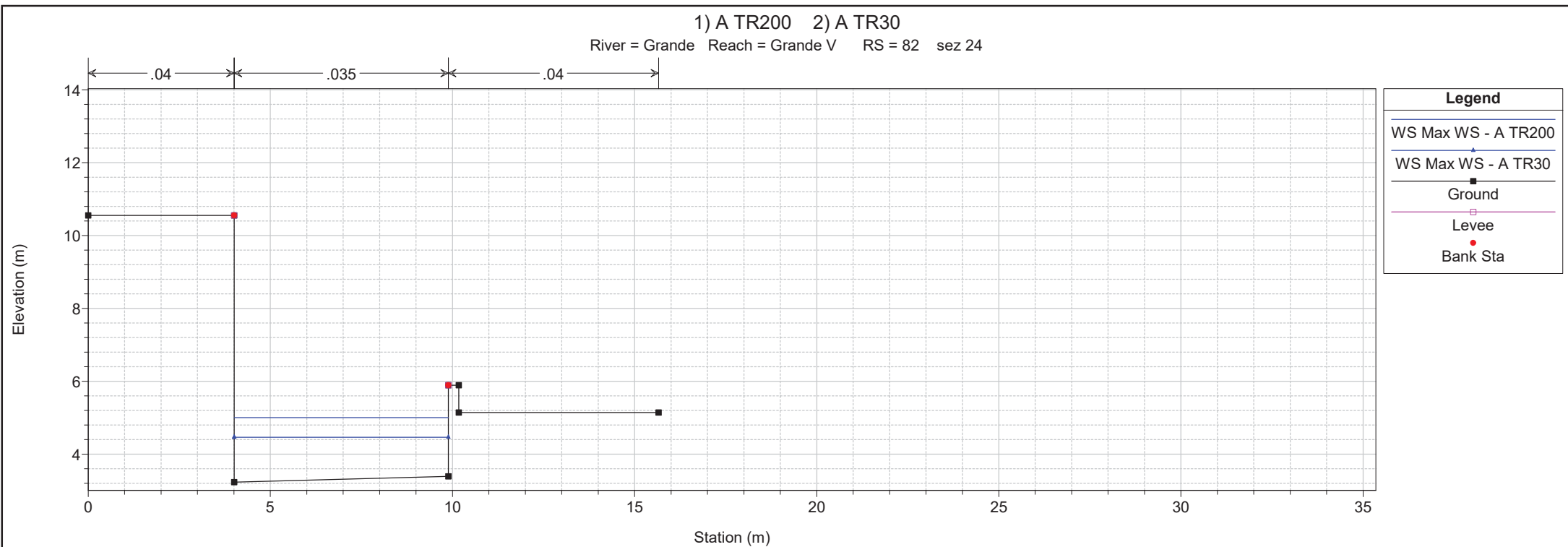

1 cm Horiz. = 1.5 m 1 cm Vert. = 1.5 m

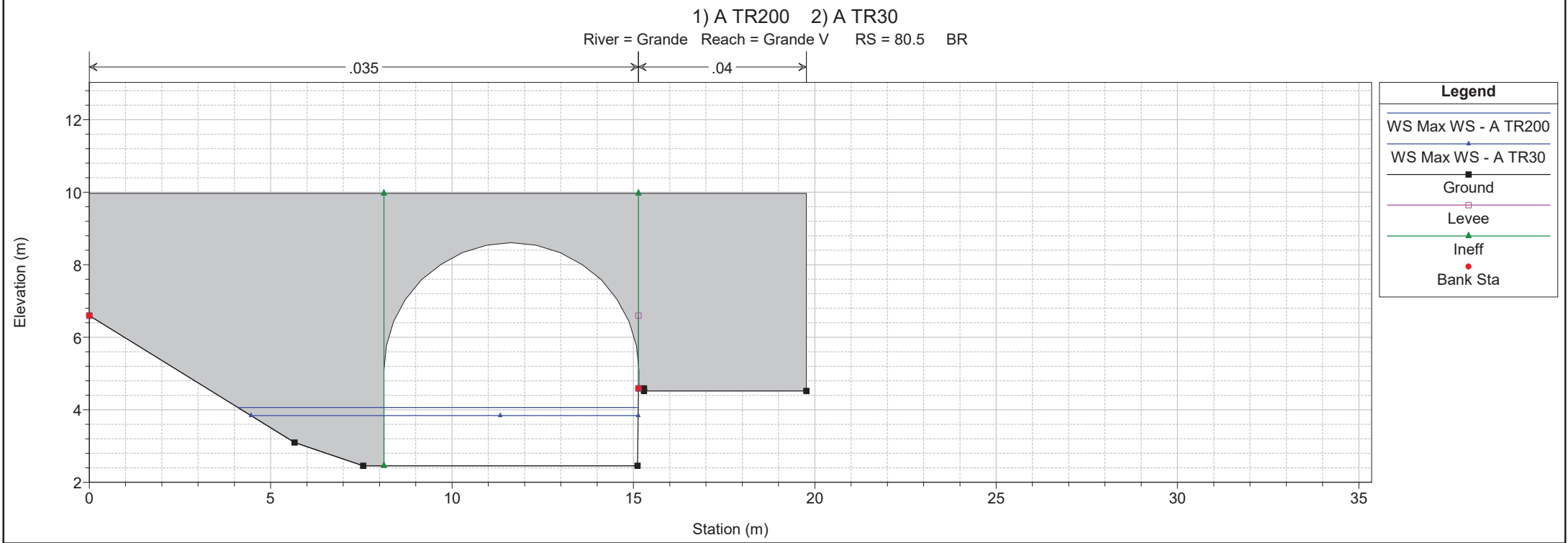
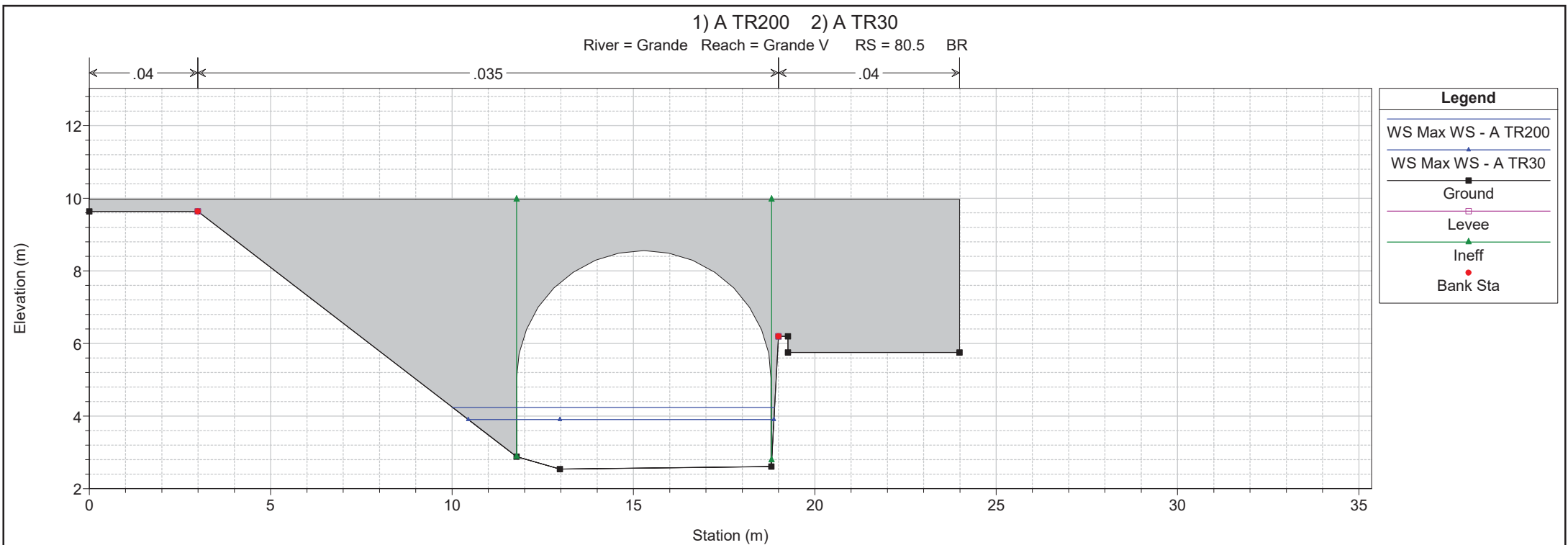

1 cm Horiz. = 1.5 m 1 cm Vert. = 1.5 m

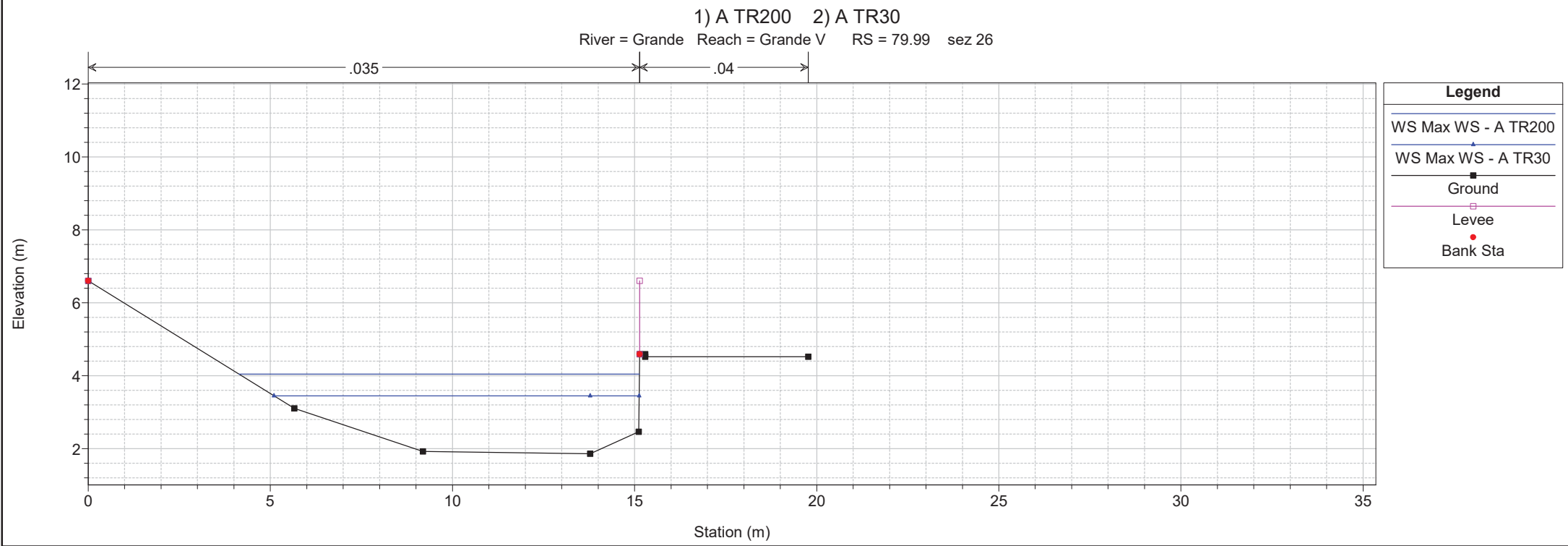
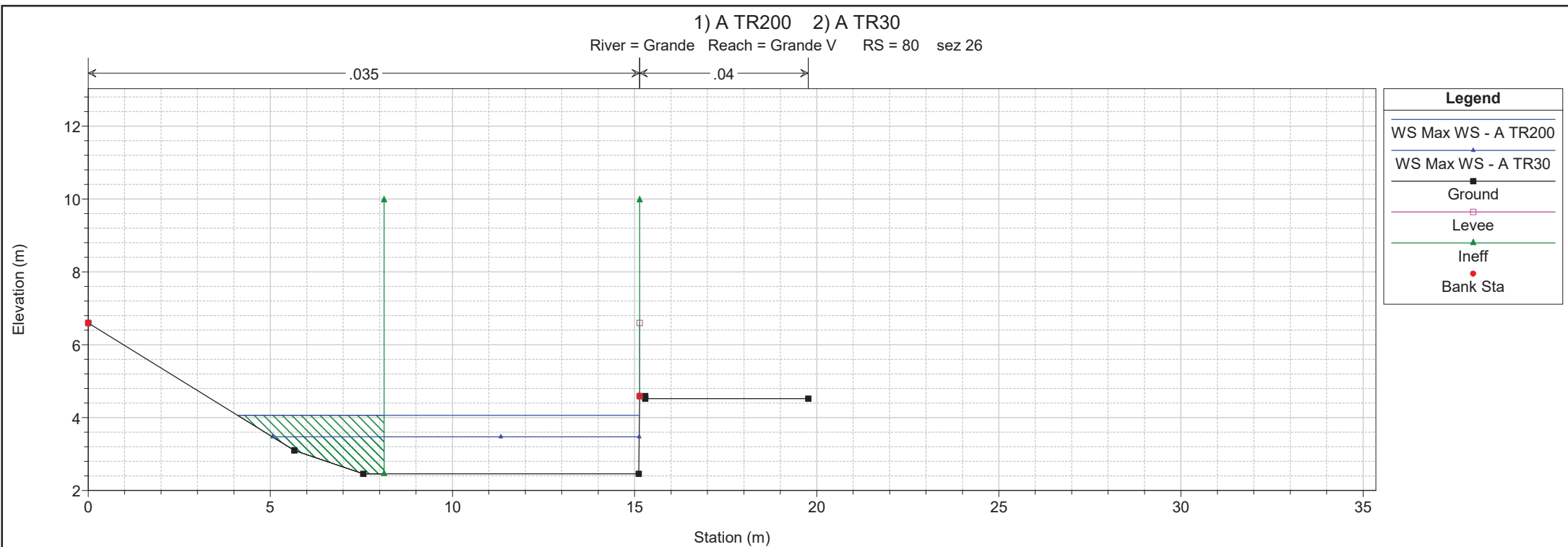

1 cm Horiz. = 1.5 m 1 cm Vert. = 1.5 m

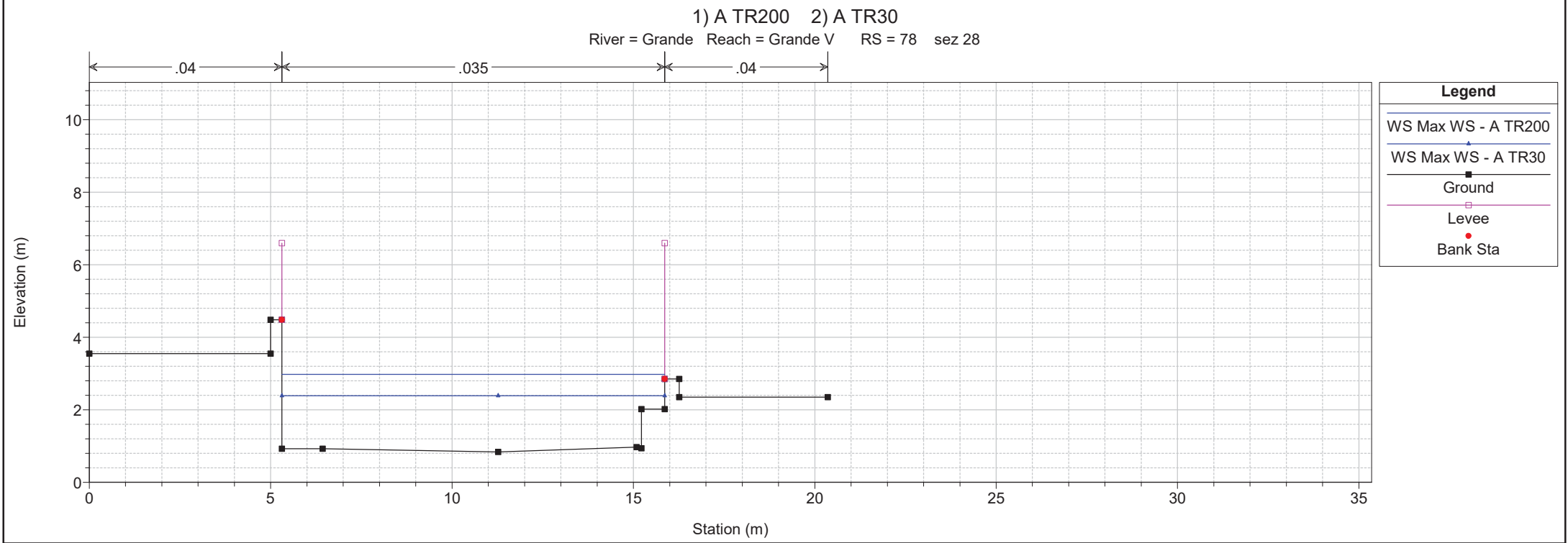
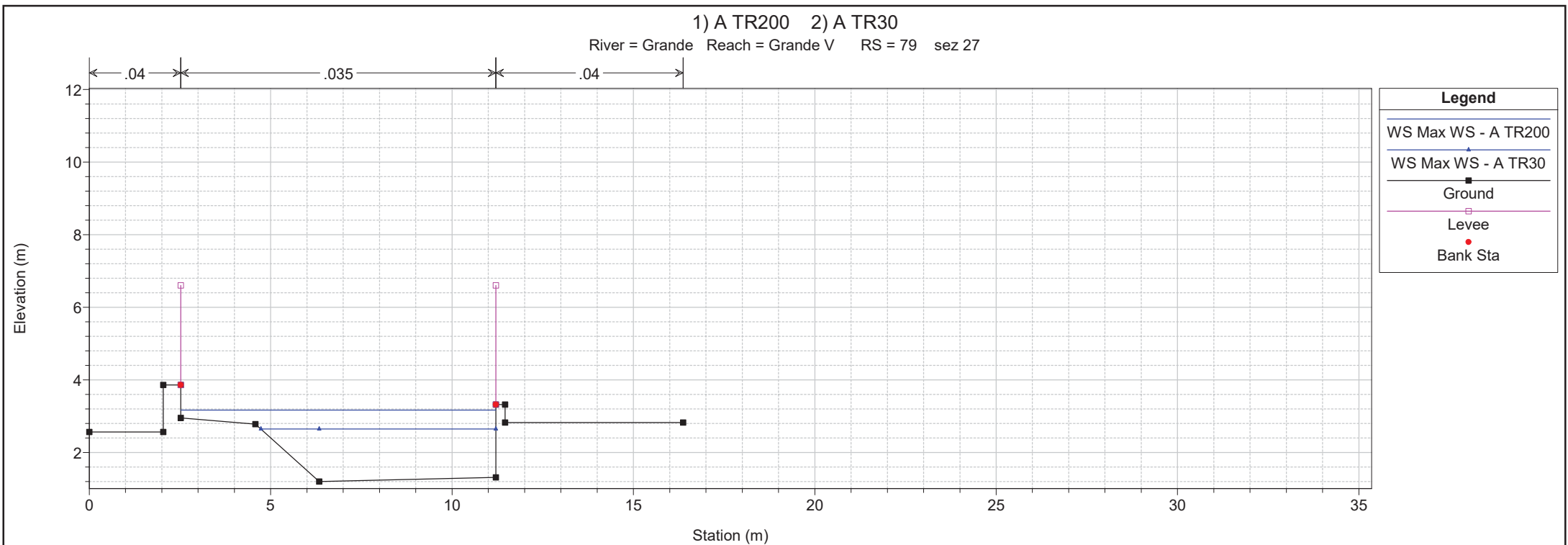

1 cm Horiz. = 1.5 m 1 cm Vert. = 1.5 m

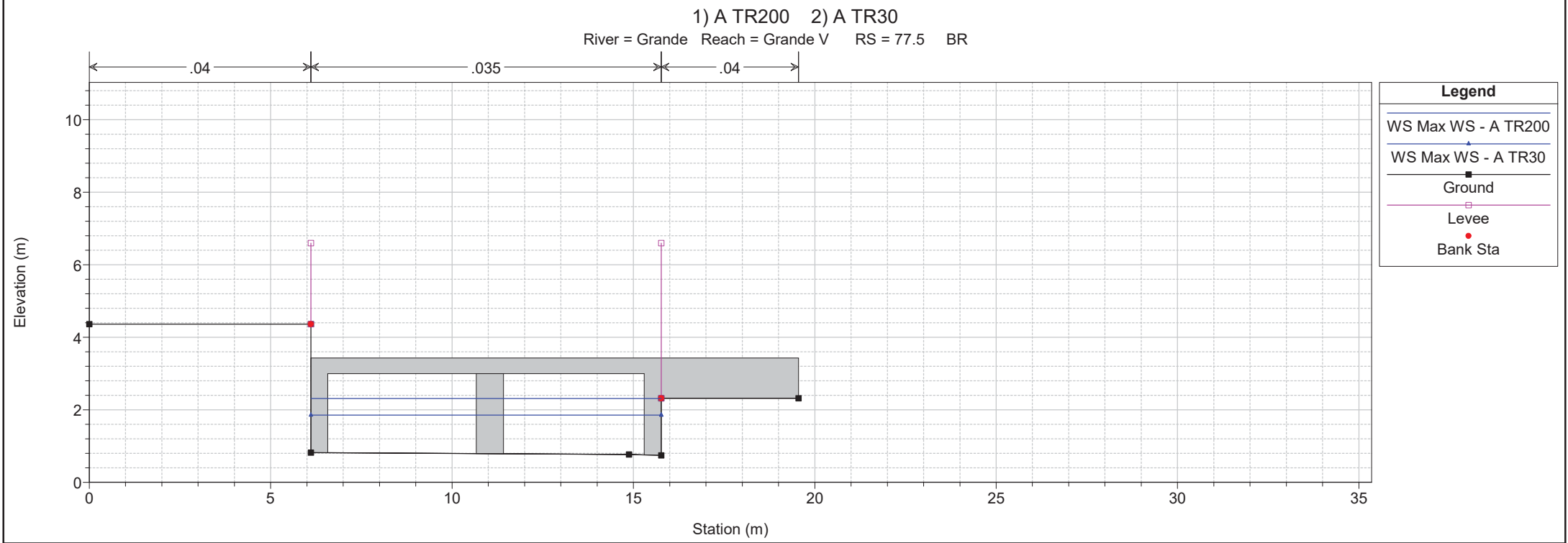
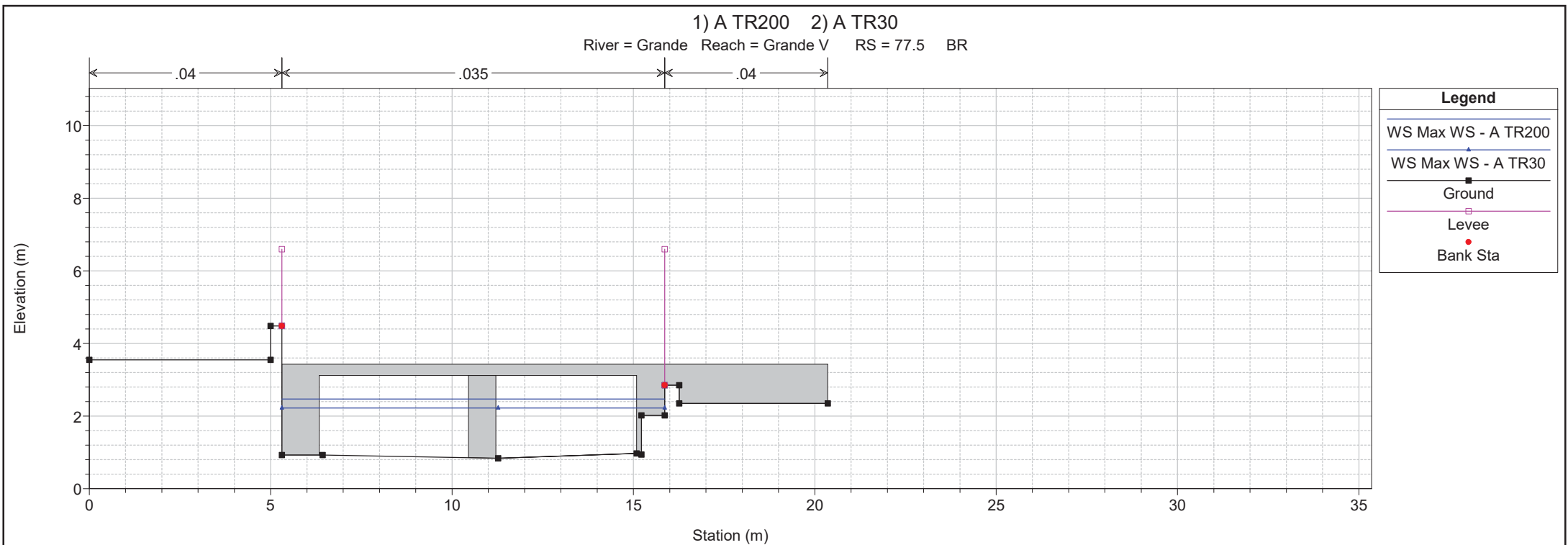

1 cm Horiz. = 1.5 m 1 cm Vert. = 1.5 m

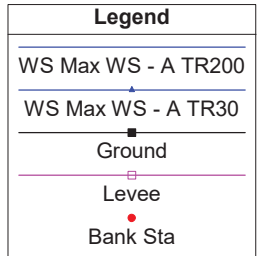
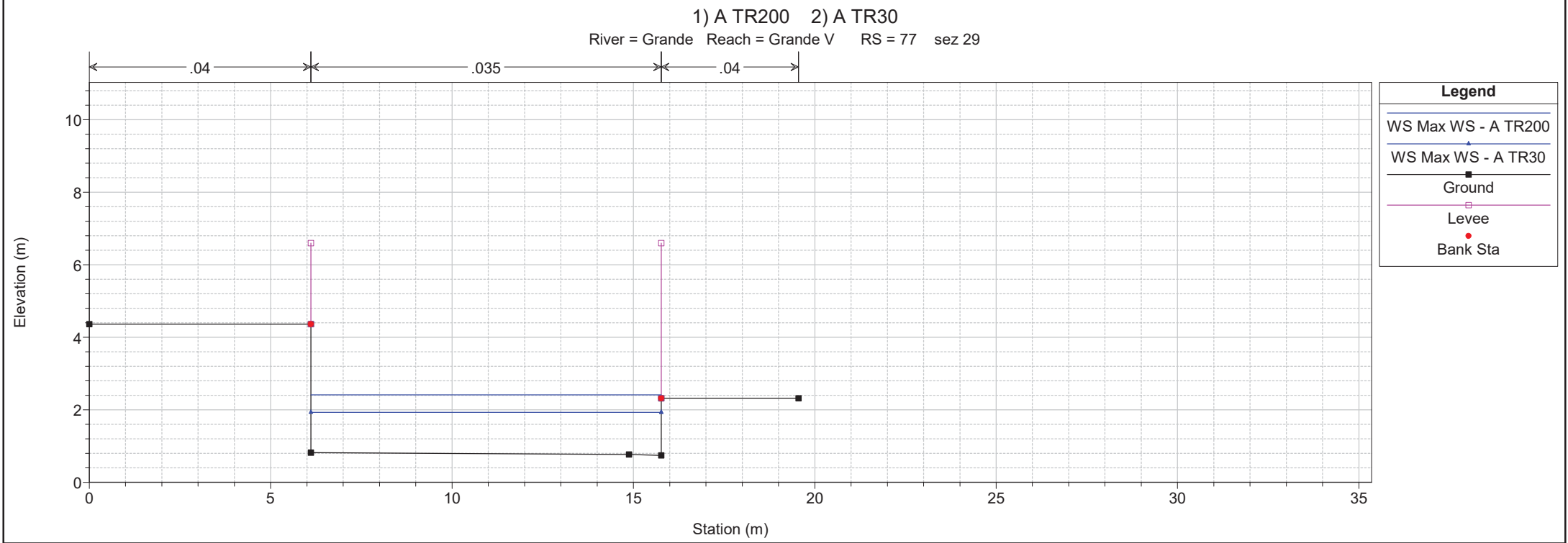
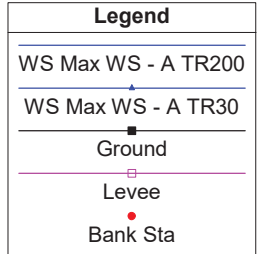
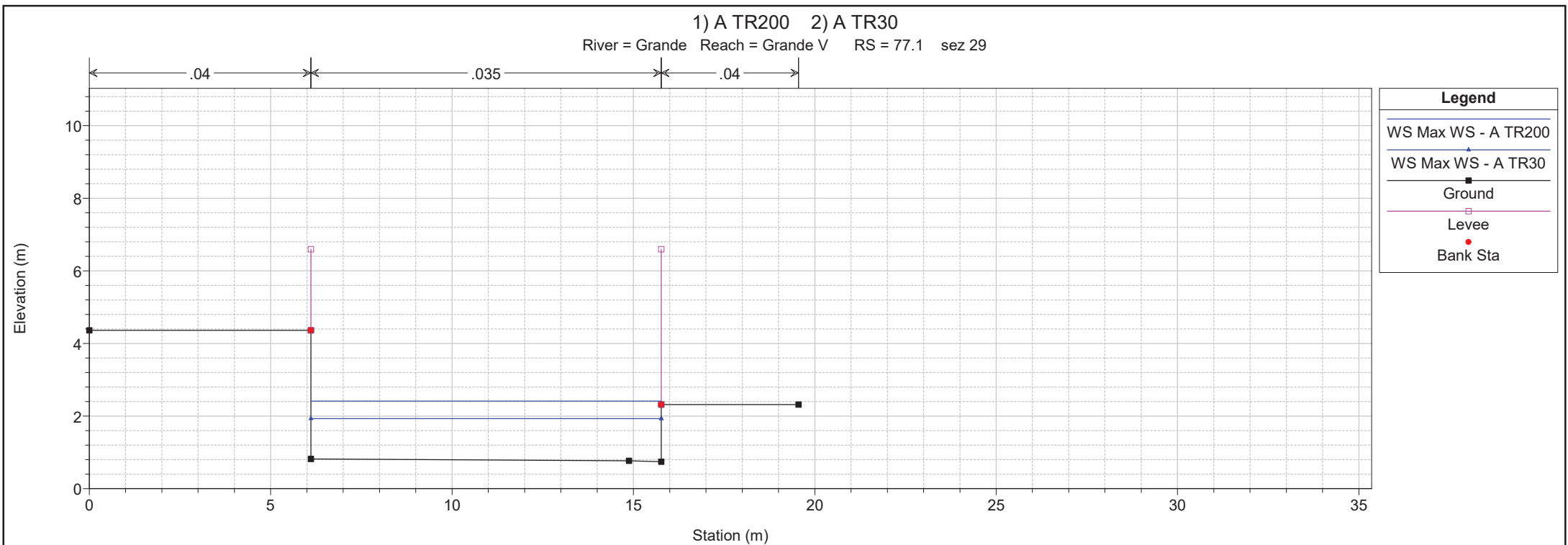

1 cm Horiz. = 1.5 m 1 cm Vert. = 1.5 m

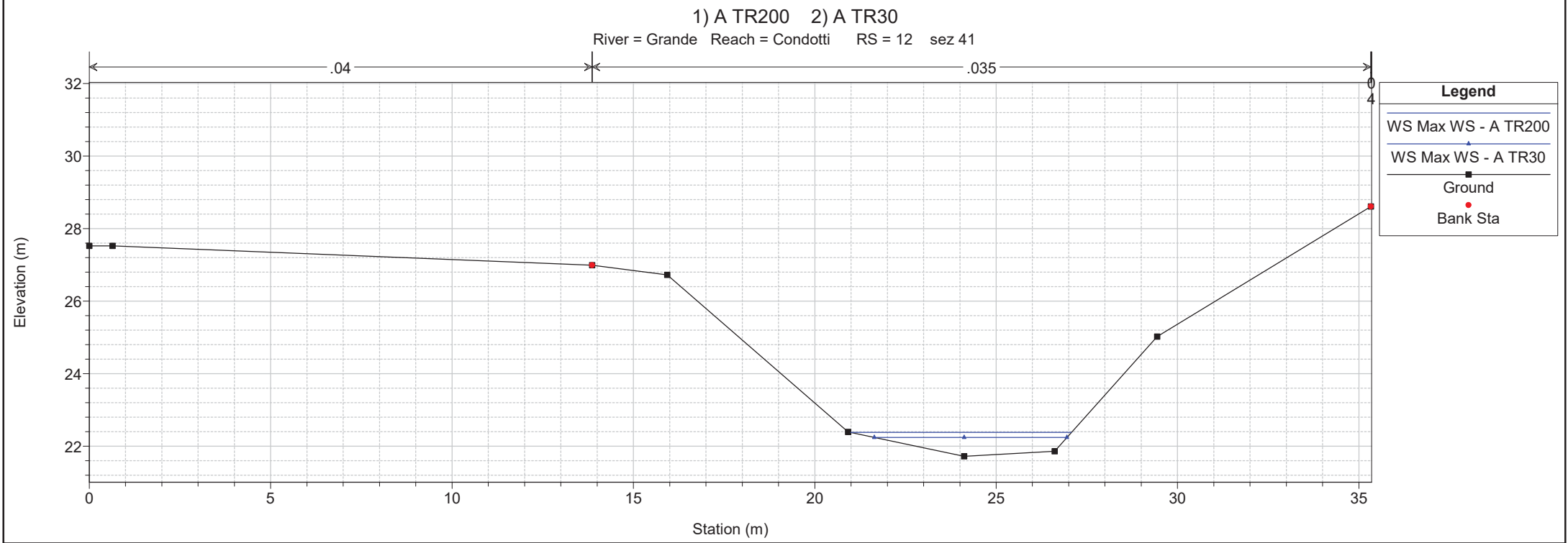
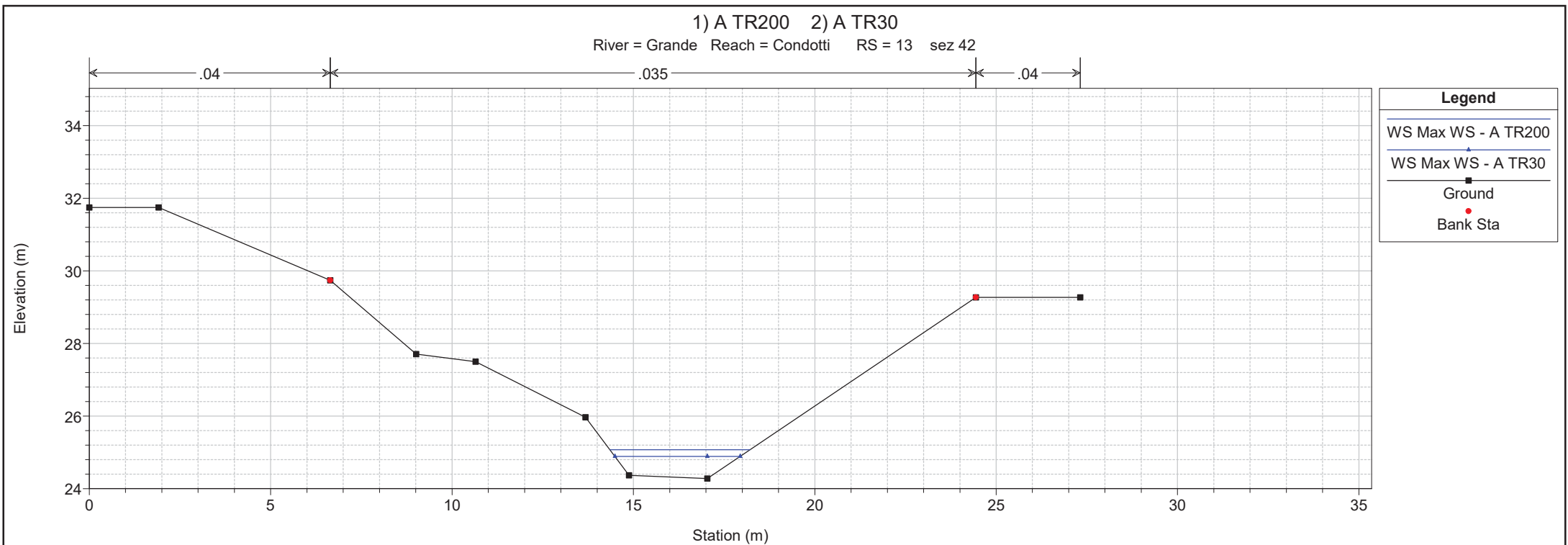

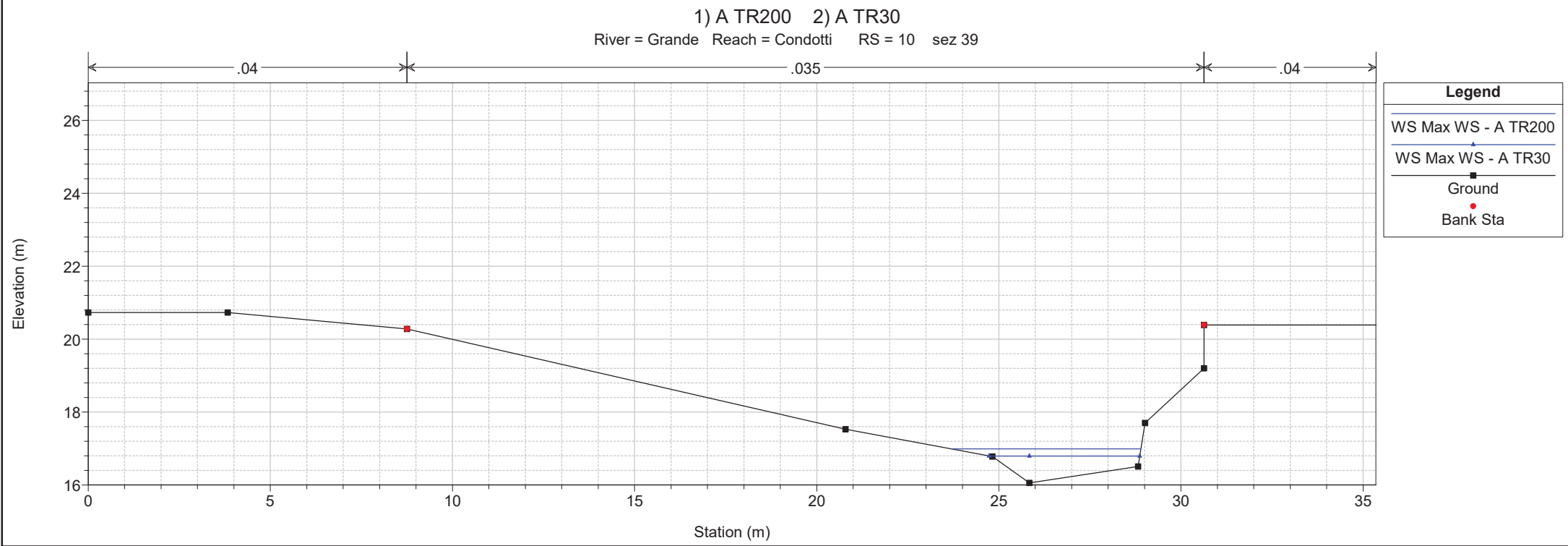
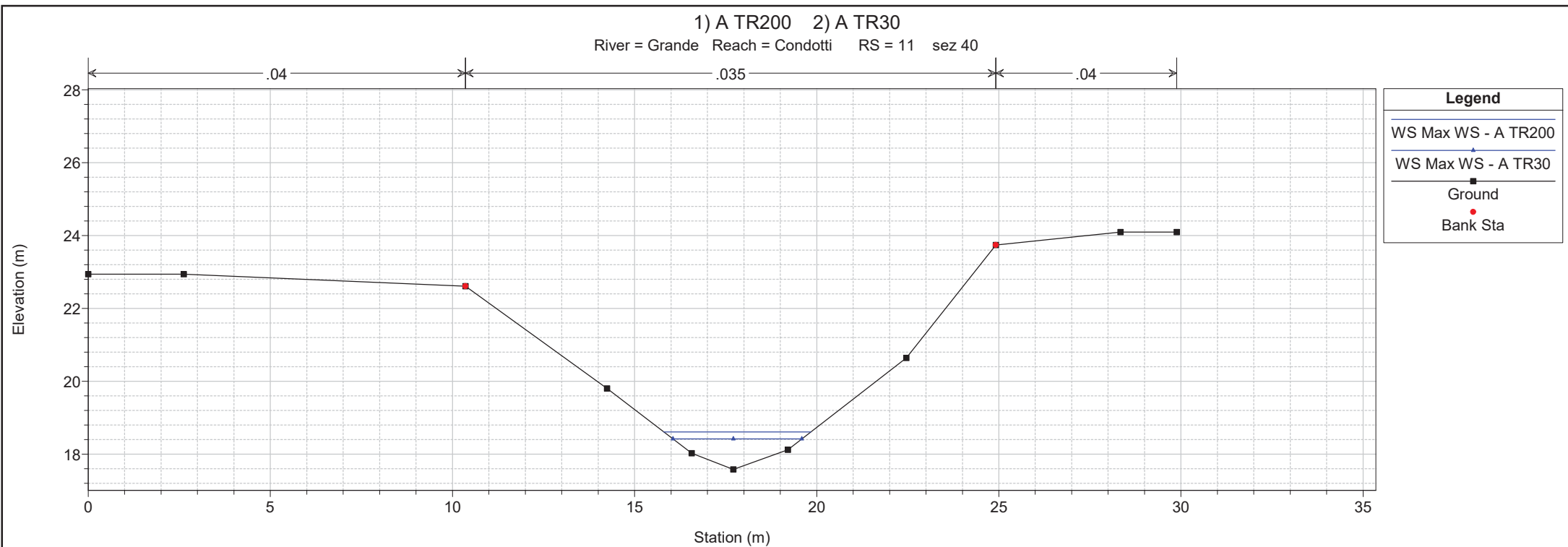

1 cm Horiz. = 1.5 m 1 cm Vert. = 1.5 m

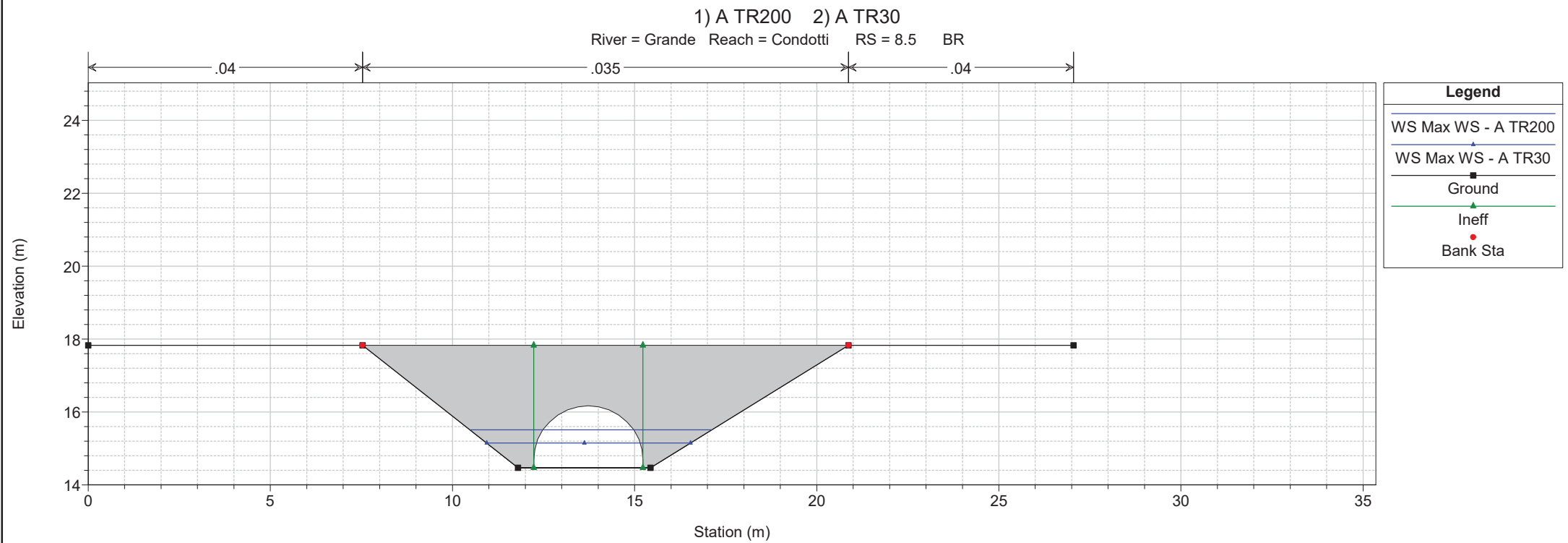
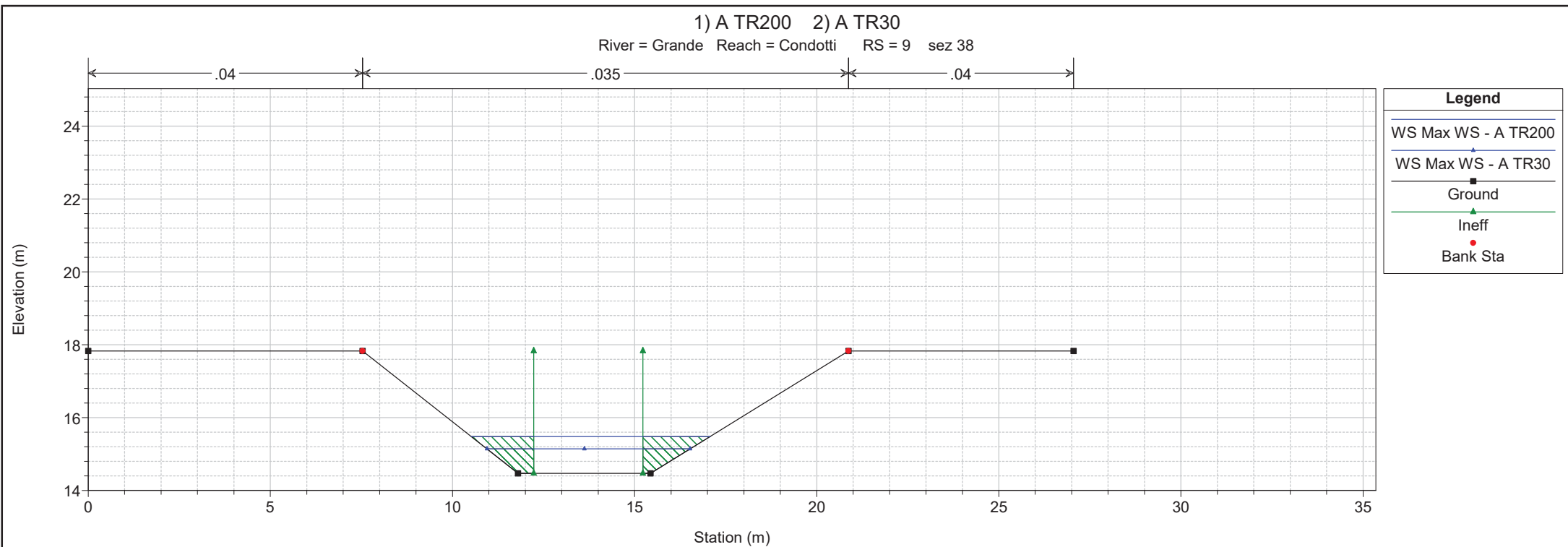

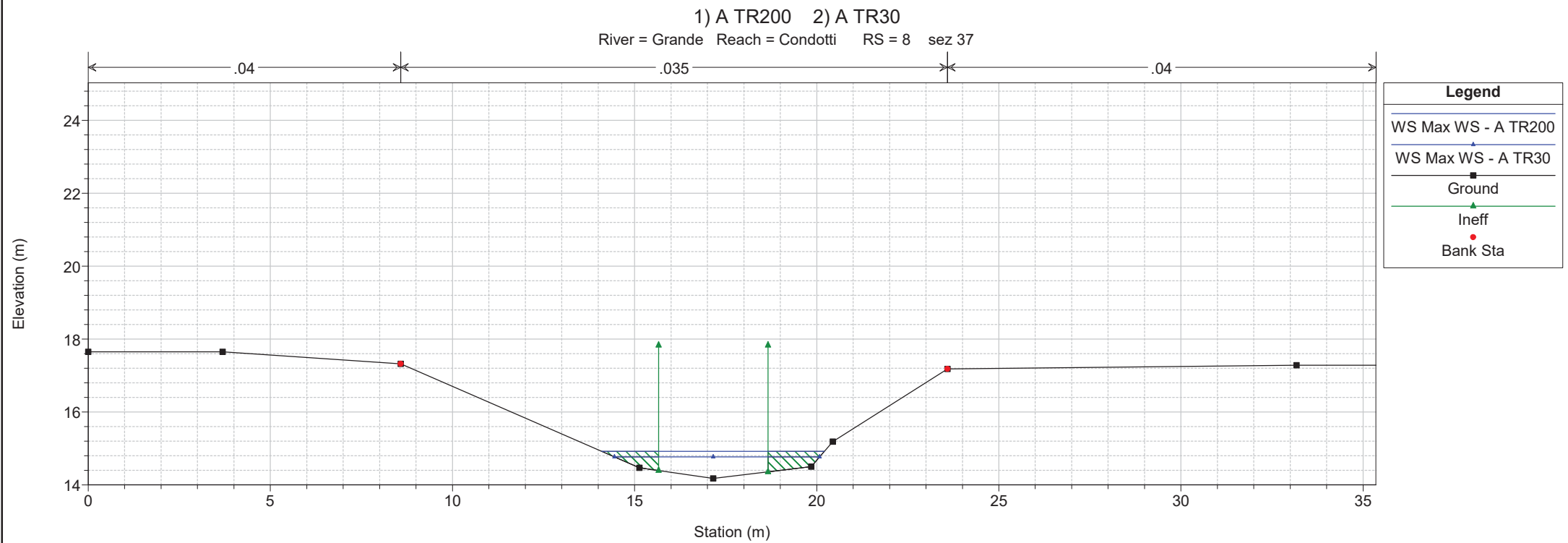
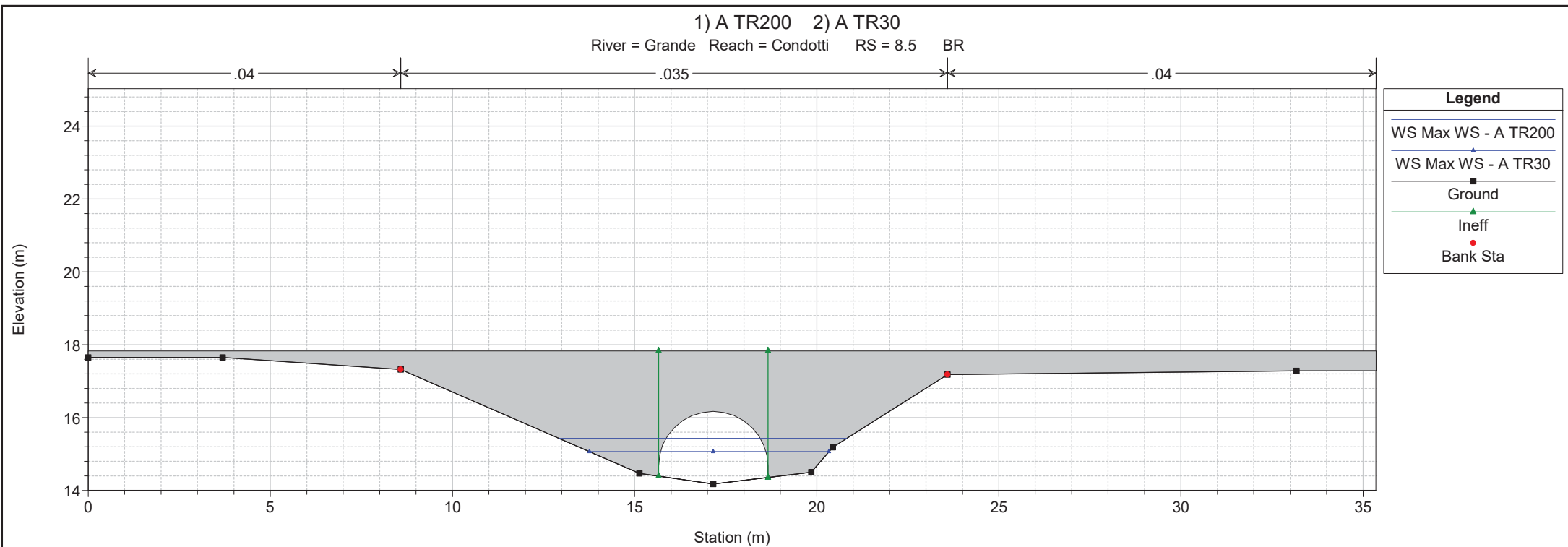

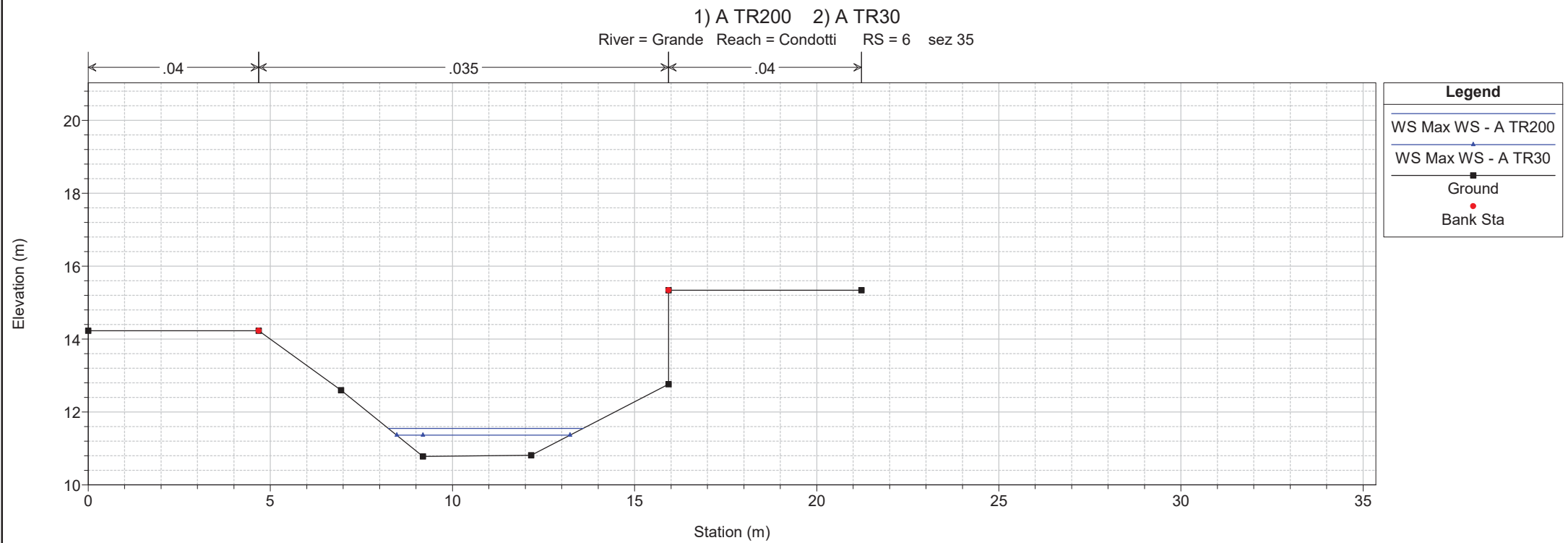
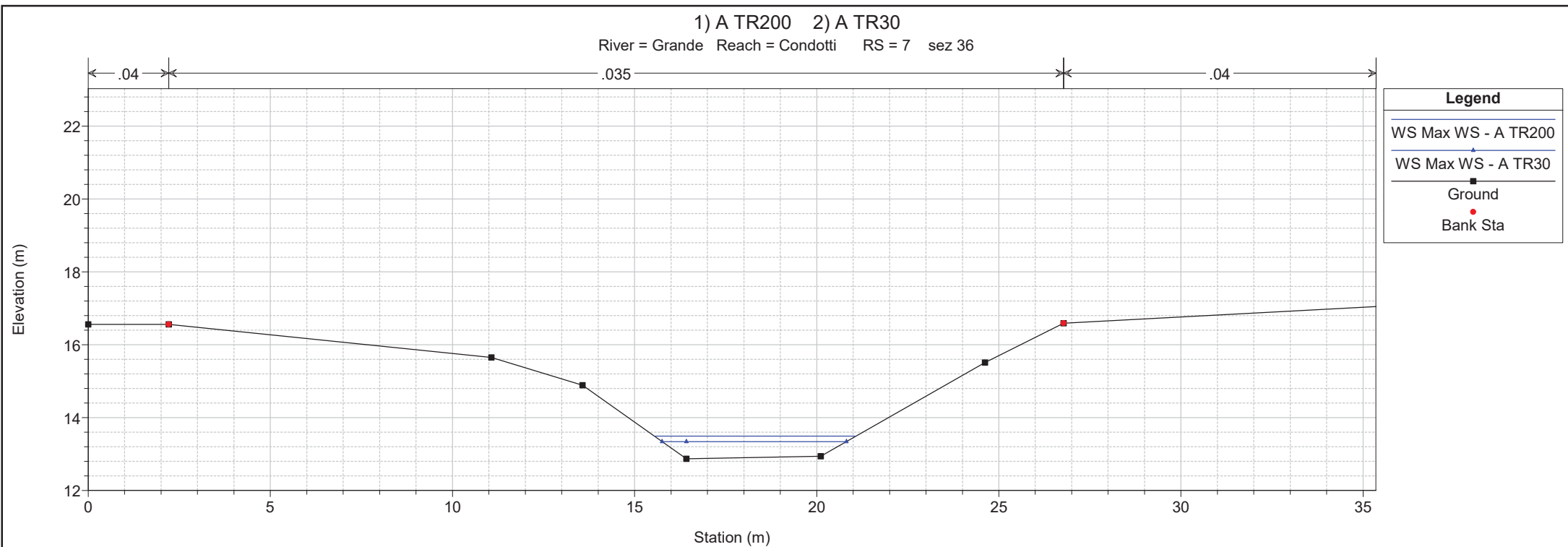

1 cm Horiz. = 1.5 m 1 cm Vert. = 1.5 m

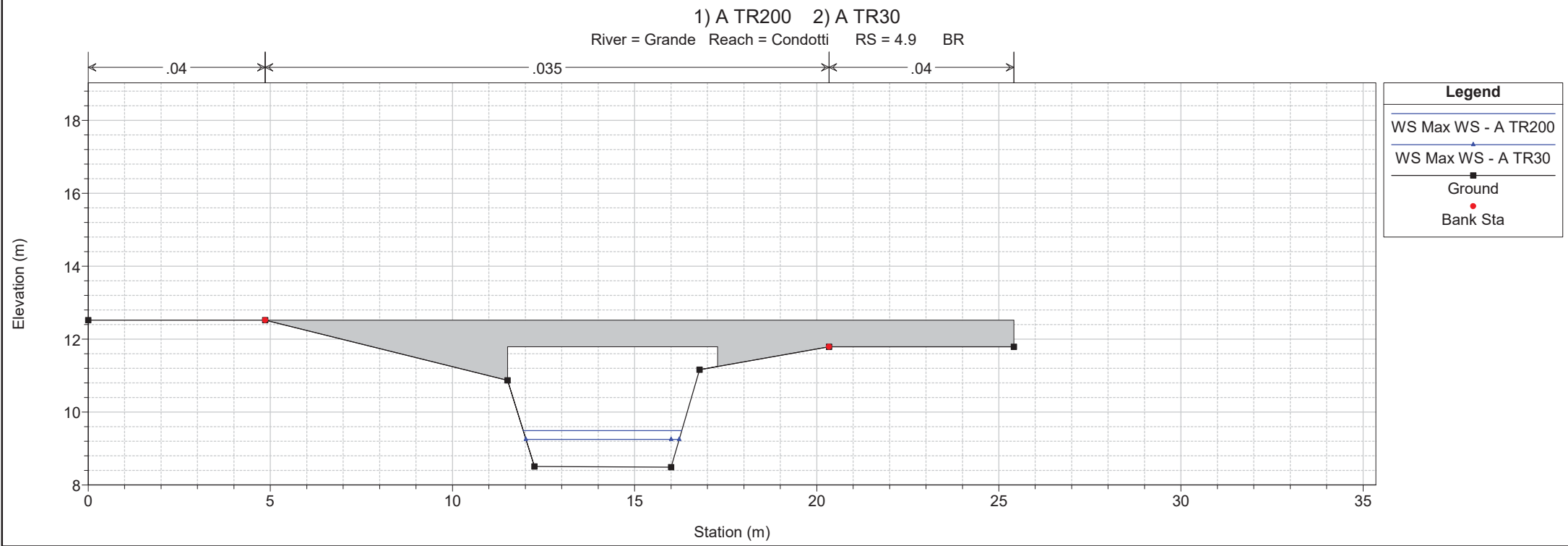
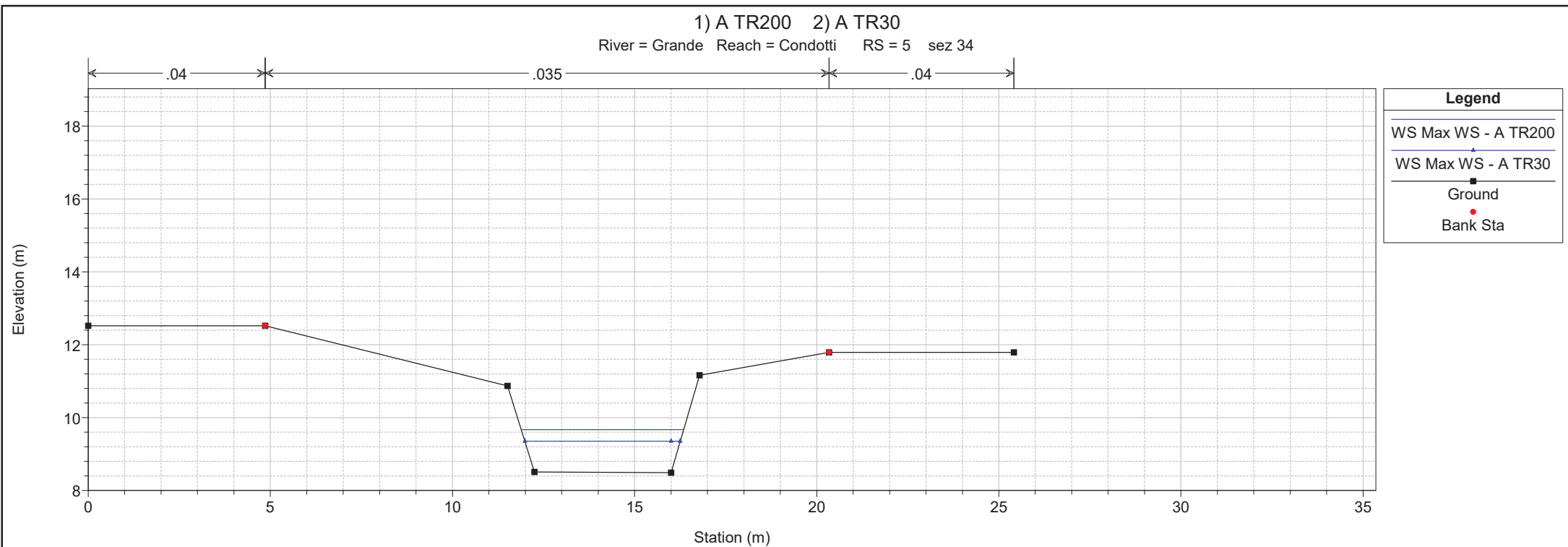

1 cm Horiz. = 1.5 m 1 cm Vert. = 1.5 m

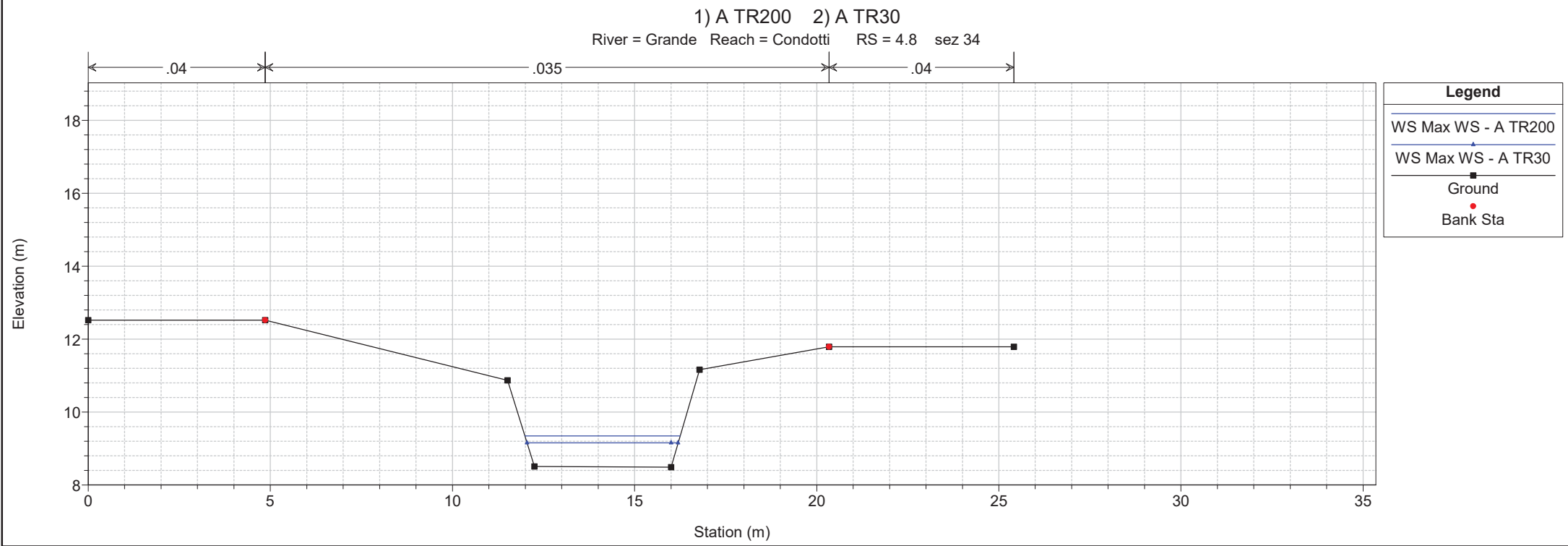
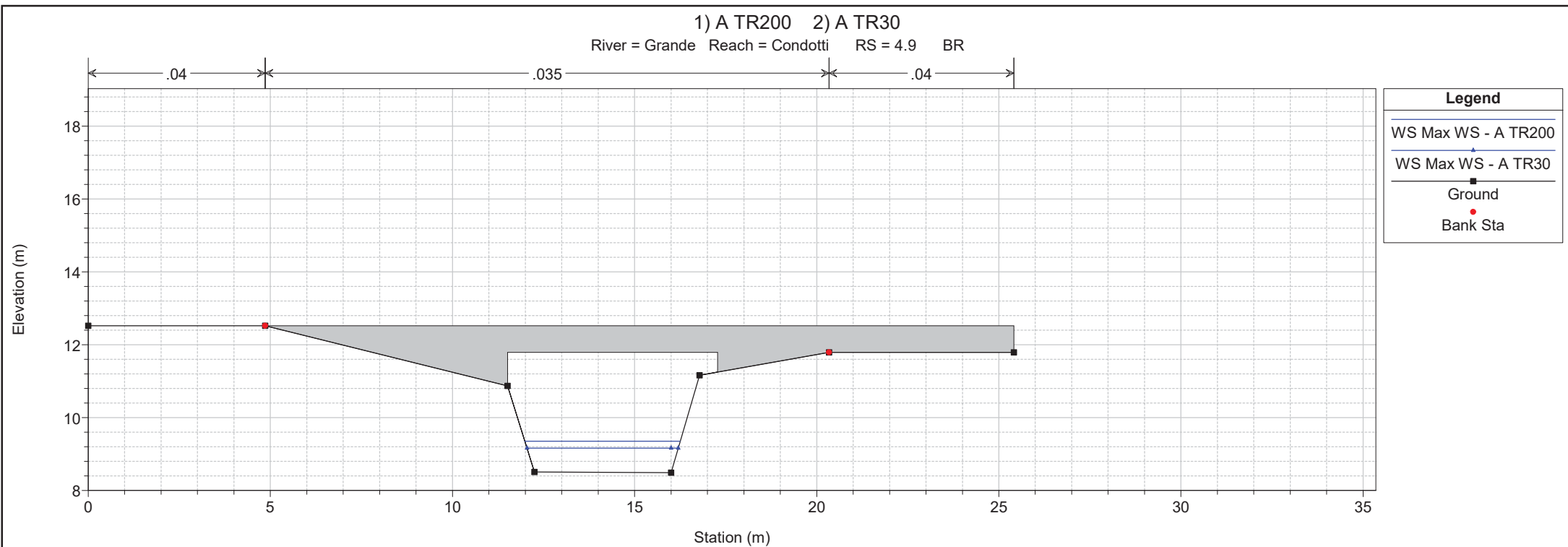

1) A TR200 2) A TR30
 River = Grande Reach = Condotti RS = 4 sez 33

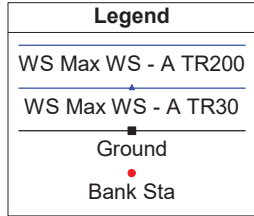
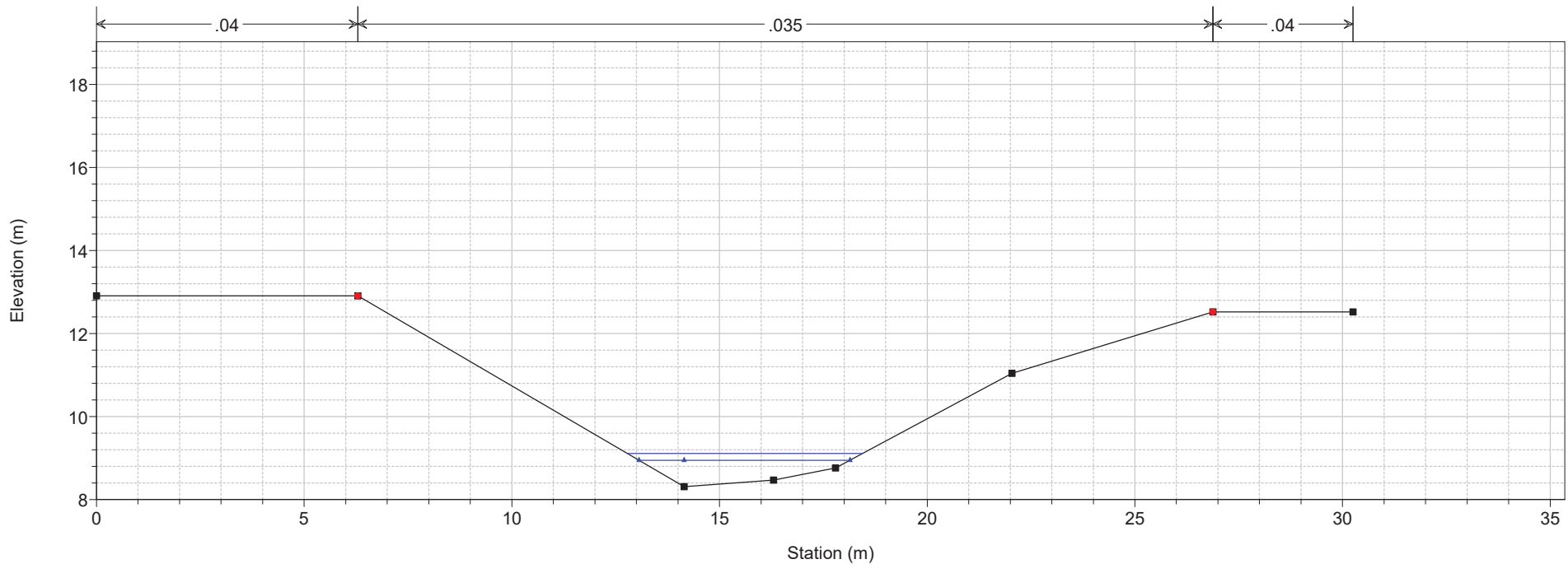

1) A TR200 2) A TR30
 River = Grande Reach = Condotti RS = 3 sez 32

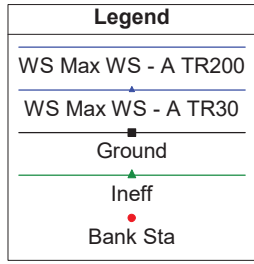
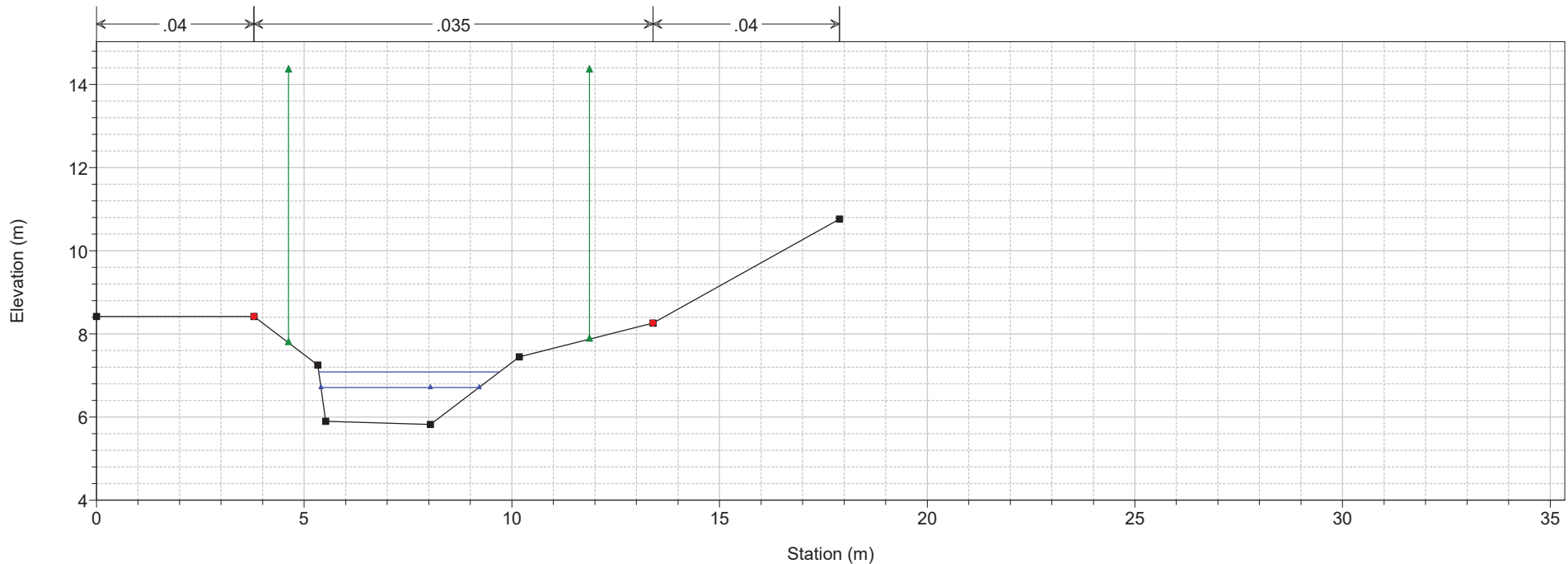

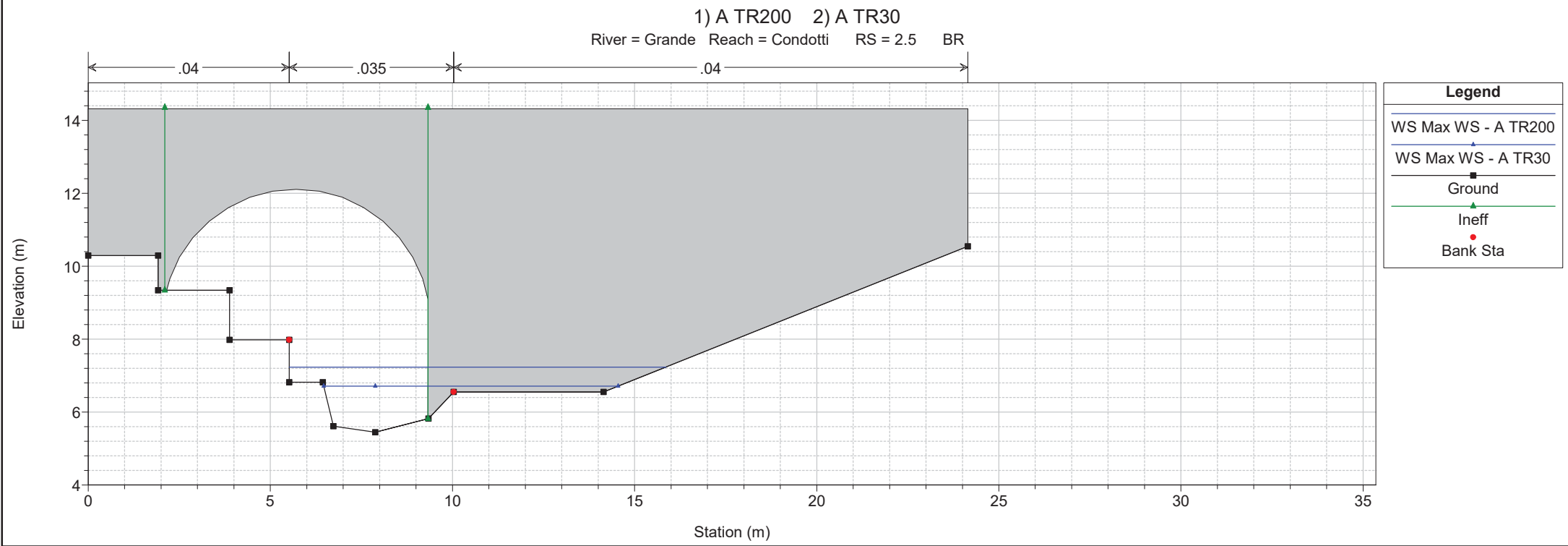
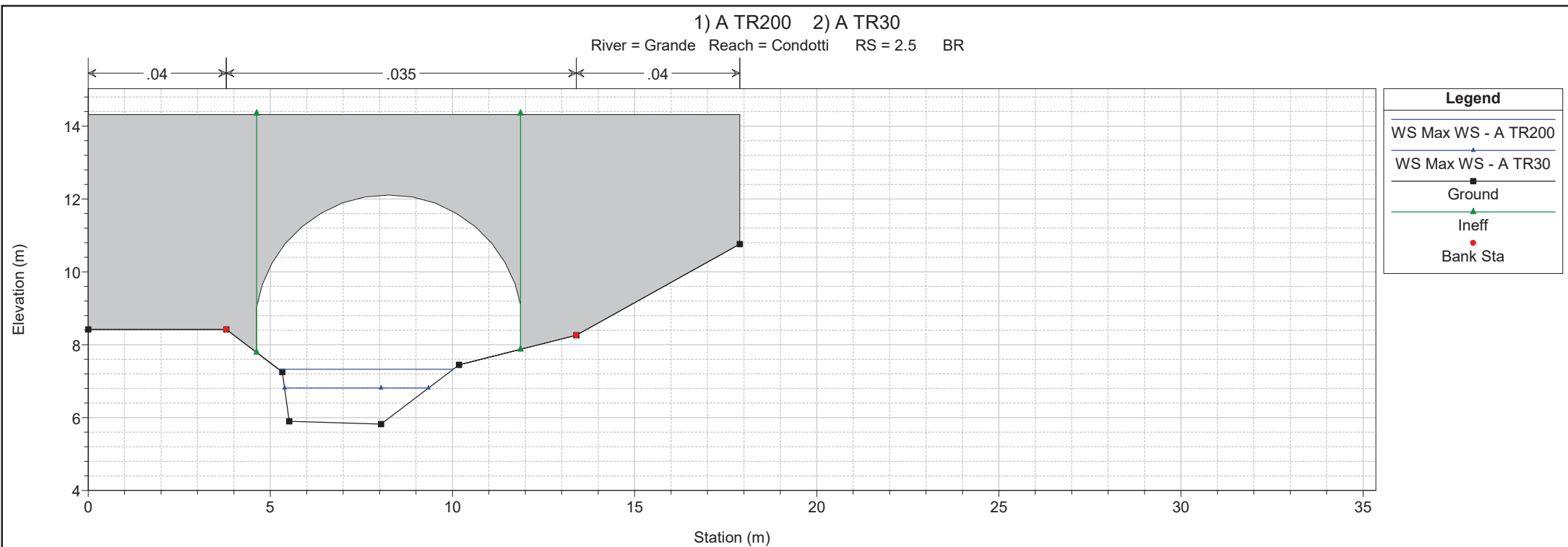

1 cm Horiz. = 1.5 m 1 cm Vert. = 1.5 m

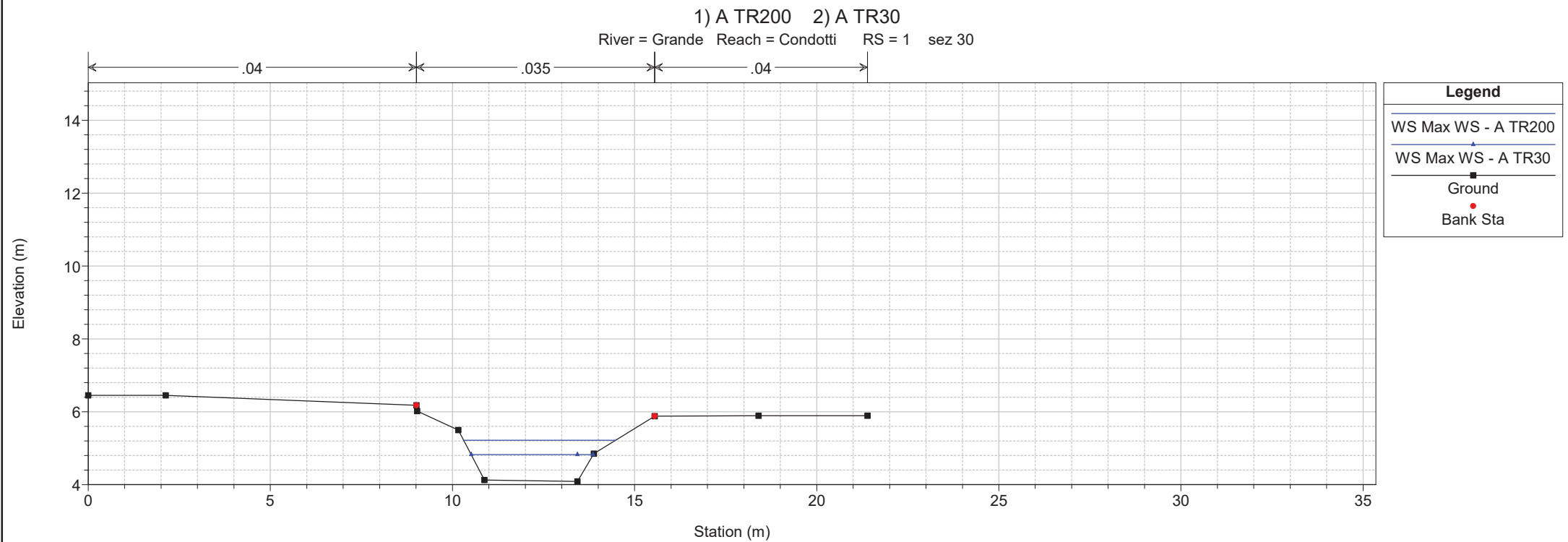
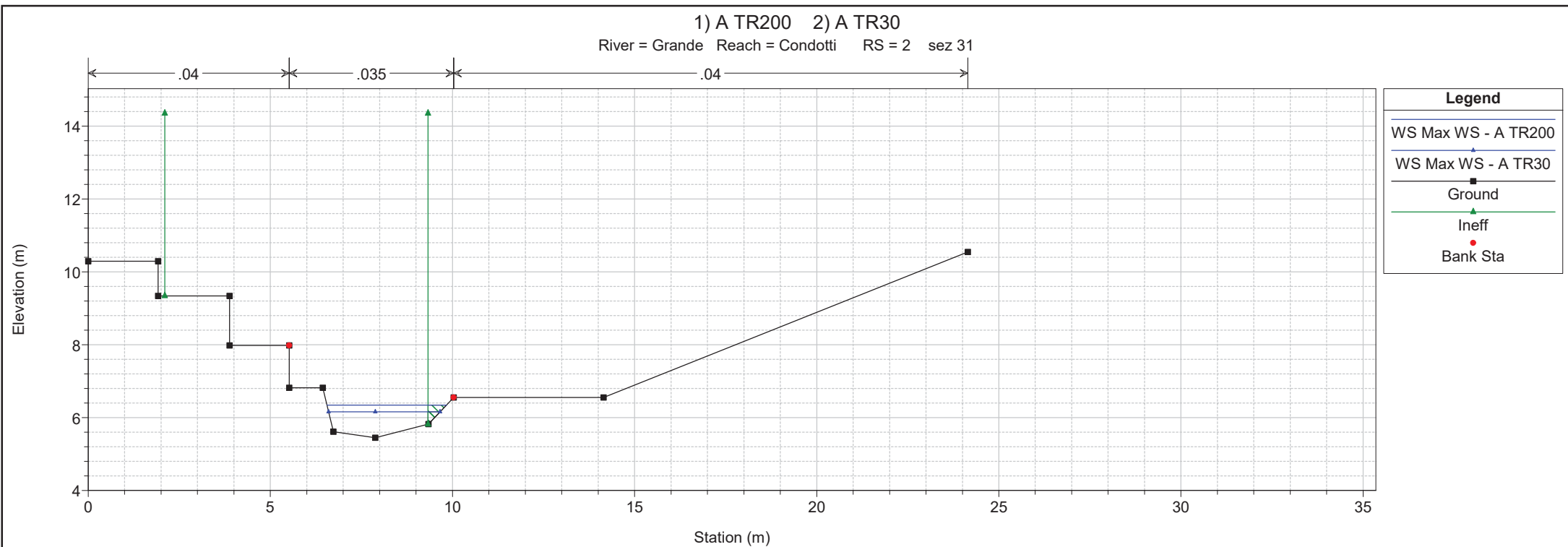

1 cm Horiz. = 1.5 m 1 cm Vert. = 1.5 m

1) A TR200 2) A TR30

River = Grande Reach = Condotti RS = 0.9

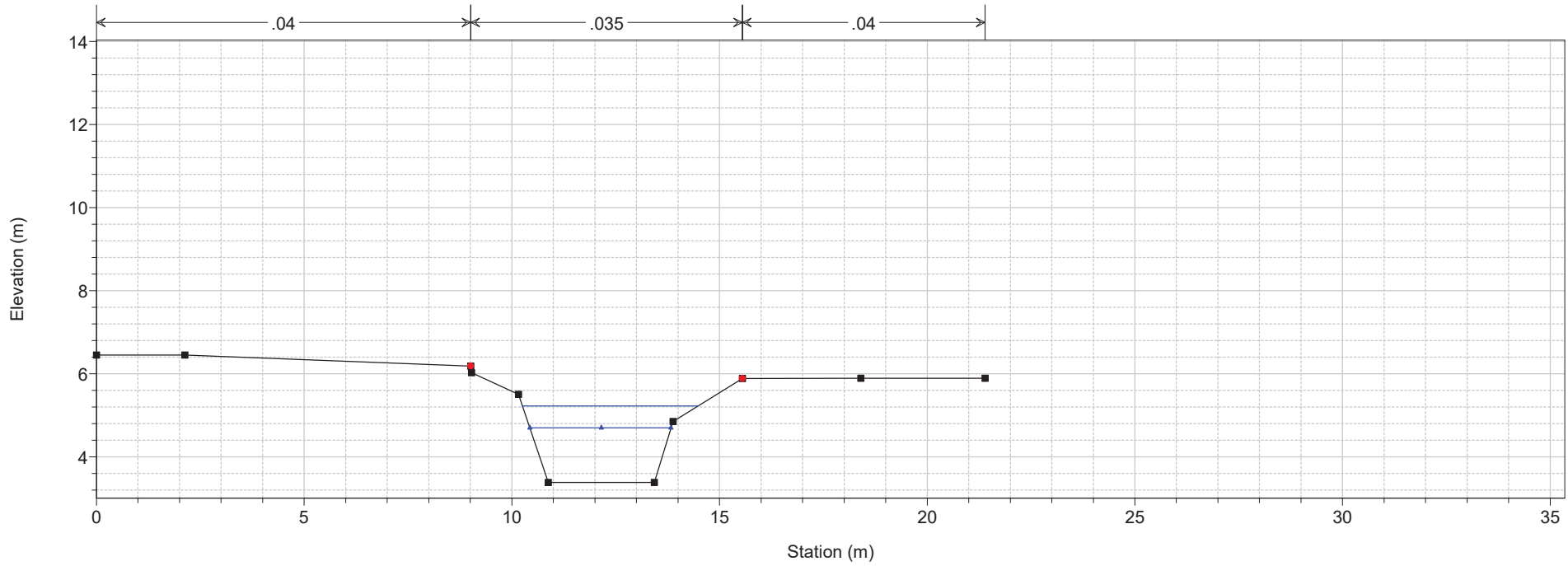

Legend

- WS Max WS - A TR200
- WS Max WS - A TR30
- Ground
- Bank Sta

Reach	River Sta	Plan	Q Total (m3/s)	Min Ch El (m)	W.S. Elev (m)	Crit W.S. (m)	E.G. Elev (m)	E.G. Slope (m/m)	Vel Chnl (m/s)	Flow Area (m2)	Top Width (m)	Froude # Chl
Condotti	13	A TR200	7.09	24.28	25.07	25.20	25.57	0.029928	3.14	2.26	3.86	1.31
Condotti	13	A TR30	4.33	24.28	24.89	24.98	25.26	0.029829	2.72	1.59	3.45	1.28
Condotti	12	A TR200	7.09	21.72	22.38	22.47	22.75	0.030016	2.72	2.60	6.08	1.33
Condotti	12	A TR30	4.33	21.72	22.24	22.31	22.53	0.030276	2.37	1.82	5.31	1.29
Condotti	11	A TR200	7.09	17.58	18.61	18.69	19.04	0.024102	2.91	2.43	4.04	1.20
Condotti	11	A TR30	4.33	17.58	18.42	18.47	18.74	0.024003	2.53	1.71	3.54	1.16
Condotti	10	A TR200	7.09	16.06	16.99	17.03	17.31	0.020916	2.52	2.81	5.19	1.10
Condotti	10	A TR30	4.33	16.06	16.80	16.82	17.06	0.020440	2.26	1.91	4.13	1.06
Condotti	9	A TR200	7.08	14.47	15.48	15.30	15.76	0.006599	2.34	3.03	6.56	0.74
Condotti	9	A TR30	4.33	14.47	15.14	15.07	15.38	0.009671	2.15	2.01	5.57	0.84
Condotti	8.5		Bridge									
Condotti	8	A TR200	7.08	14.18	14.92	15.11	15.61	0.030389	3.68	1.92	6.11	1.47
Condotti	8	A TR30	4.33	14.18	14.77	14.88	15.21	0.028072	2.95	1.47	5.63	1.35
Condotti	7	A TR200	7.08	12.87	13.49	13.56	13.84	0.023976	2.63	2.69	5.53	1.20
Condotti	7	A TR30	4.33	12.87	13.34	13.39	13.60	0.024356	2.26	1.92	5.06	1.17
Condotti	6	A TR200	8.90	10.78	11.55	11.63	11.96	0.022176	2.83	3.15	5.36	1.18
Condotti	6	A TR30	5.48	10.78	11.36	11.42	11.68	0.023553	2.50	2.19	4.76	1.17
Condotti	5	A TR200	8.89	8.49	9.67	9.31	9.85	0.005857	1.85	4.81	4.46	0.57
Condotti	5	A TR30	5.47	8.49	9.35	9.09	9.48	0.006027	1.61	3.41	4.26	0.57
Condotti	4.9		Bridge									
Condotti	4.8	A TR200	8.89	8.49	9.35	9.31	9.70	0.016192	2.63	3.39	4.26	0.94
Condotti	4.8	A TR30	5.47	8.49	9.16	9.09	9.38	0.013418	2.10	2.60	4.15	0.85
Condotti	4	A TR200	8.89	8.31	9.11	9.23	9.57	0.028894	3.02	2.94	5.66	1.34
Condotti	4	A TR30	5.47	8.31	8.95	9.04	9.30	0.030010	2.64	2.07	5.08	1.32
Condotti	3	A TR200	8.89	5.82	7.08	6.83	7.31	0.008221	2.10	4.23	4.35	0.68
Condotti	3	A TR30	5.47	5.82	6.71	6.58	6.92	0.010607	2.01	2.72	3.81	0.76
Condotti	2.5		Bridge									
Condotti	2	A TR200	8.89	5.45	6.35	6.63	7.32	0.046490	4.36	2.04	3.28	1.63
Condotti	2	A TR30	5.47	5.45	6.16	6.35	6.82	0.043599	3.61	1.52	3.06	1.55
Condotti	1	A TR200	8.78	4.09	5.22	5.11	5.52	0.012430	2.44	3.60	4.18	0.84
Condotti	1	A TR30	5.41	4.09	4.82	4.84	5.16	0.020345	2.58	2.10	3.35	1.04
Condotti	0.9	A TR200	8.74	3.38	5.22	4.40	5.33	0.003241	1.49	5.88	4.23	0.40
Condotti	0.9	A TR30	5.22	3.38	4.69	4.11	4.78	0.003294	1.34	3.91	3.40	0.40
Grande M	100	A TR200	30.36	34.02	35.56	35.58	35.98	0.015692	2.86	10.60	13.86	1.05
Grande M	100	A TR30	17.27	34.02	35.14	35.31	35.72	0.048775	3.37	5.13	12.48	1.67
Grande M	99	A TR200	30.36	33.52	35.06	35.29	35.91	0.021637	4.14	7.78	9.17	1.21
Grande M	99	A TR30	17.27	33.52	34.66	34.79	35.31	0.023015	3.57	4.83	5.44	1.21
Grande M	98	A TR200	30.36	32.20	33.47	33.72	34.42	0.027700	4.33	7.01	6.80	1.36
Grande M	98	A TR30	17.26	32.20	33.13	33.29	33.79	0.027703	3.61	4.78	6.33	1.33
Grande M	97	A TR200	30.01	29.56	30.81	31.11	31.75	0.031367	4.31	6.96	7.98	1.47
Grande M	97	A TR30	17.10	29.56	30.42	30.67	31.23	0.036725	3.99	4.29	6.27	1.54
Grande M	96.5	A TR200	35.19	27.45	29.57	29.68	30.26	0.019772	3.69	9.54	9.14	1.15
Grande M	96.5	A TR30	19.94	27.45	29.09	29.27	29.73	0.023353	3.53	5.64	6.34	1.20
Grande M	96	A TR200	35.32	26.21	27.97	28.33	29.23	0.030923	4.96	7.12	5.46	1.39
Grande M	96	A TR30	20.02	26.21	27.51	27.75	28.42	0.030096	4.21	4.76	4.78	1.35
Grande M	95	A TR200	35.71	20.84	22.09	22.36	23.06	0.028494	4.37	8.17	8.64	1.44
Grande M	95	A TR30	20.31	20.84	21.76	21.95	22.45	0.028440	3.69	5.51	7.65	1.39
Grande M	94	A TR200	35.97	17.26	18.51	18.68	19.29	0.021649	3.91	9.21	9.55	1.27
Grande M	94	A TR30	20.49	17.26	18.18	18.30	18.74	0.022749	3.31	6.20	8.83	1.26
Grande M	93	A TR200	36.22	14.83	16.40	16.62	17.36	0.023734	4.34	8.34	6.95	1.27
Grande M	93	A TR30	20.64	14.83	15.98	16.14	16.68	0.023458	3.71	5.56	6.02	1.23
Grande M	92	A TR200	36.66	11.01	12.74	12.79	13.23	0.014401	3.13	12.64	16.69	0.91
Grande M	92	A TR30	20.91	11.01	12.14	12.14	12.63	0.015640	3.09	6.76	6.97	1.00
Grande M	91	A TR200	36.79	9.93	12.60	11.76	12.81	0.003055	1.99	18.45	10.60	0.48

Reach	River Sta	Plan	Q Total (m3/s)	Min Ch El (m)	W.S. Elev (m)	Crit W.S. (m)	E.G. Elev (m)	E.G. Slope (m/m)	Vel Chnl (m/s)	Flow Area (m2)	Top Width (m)	Froude # Chl
Grande M	91	A TR30	20.99	9.93	11.81	11.28	12.00	0.004247	1.93	10.88	8.47	0.54
Grande M	90.5		Bridge									
Grande M	90	A TR200	36.78	9.66	11.50	11.83	12.58	0.041853	4.62	7.96	8.62	1.53
Grande M	90	A TR30	20.99	9.66	11.06	11.41	12.06	0.047608	4.43	4.74	5.55	1.53
Grande M	89	A TR200	36.91	8.85	10.64	10.65	11.50	0.019448	4.10	9.01	5.35	1.01
Grande M	89	A TR30	21.07	8.85	10.14	10.12	10.70	0.017490	3.33	6.32	5.32	0.98
Grande M	88	A TR200	37.13	7.74	9.47	9.54	10.22	0.017160	3.83	9.70	7.46	1.07
Grande M	88	A TR30	21.19	7.74	9.03	9.05	9.55	0.016404	3.21	6.60	6.67	1.03
Grande M	87	A TR200	37.40	6.40	8.35	8.13	8.74	0.007745	2.77	13.50	10.58	0.78
Grande M	87	A TR30	21.34	6.40	7.68	7.72	8.14	0.015892	3.01	7.08	8.60	1.06
Grande M	86	A TR200	37.50	5.69	8.11	7.49	8.57	0.007671	2.99	12.56	5.39	0.62
Grande M	86	A TR30	21.40	5.69	7.44	6.94	7.73	0.006380	2.40	8.92	5.39	0.59
Grande M	85.5		Bridge									
Grande M	85.3	A TR200	37.50	5.69	7.06	7.49	8.57	0.040663	5.44	6.90	5.34	1.53
Grande M	85.3	A TR30	21.40	5.69	6.63	6.94	7.71	0.041594	4.60	4.66	5.15	1.54
Grande M	85	A TR200	37.51	5.61	7.03	7.13	7.86	0.020228	4.04	9.28	6.82	1.11
Grande M	85	A TR30	21.40	5.61	6.60	6.67	7.18	0.020286	3.36	6.37	6.77	1.11
Grande M	84	A TR200	37.70	4.42	6.54	6.16	6.85	0.006341	2.49	15.13	10.29	0.66
Grande M	84	A TR30	21.52	4.42	5.91	5.79	6.21	0.010485	2.43	8.87	9.74	0.81
Grande M	83	A TR200	37.69	3.61	5.75	5.80	6.69	0.020276	4.30	8.76	5.04	1.04
Grande M	83	A TR30	21.51	3.61	5.17	5.18	5.83	0.018454	3.59	6.00	4.59	1.00
Grande M	82.9	A TR200	35.26	3.37	5.22	5.44	6.35	0.027107	4.71	7.49	4.73	1.19
Grande M	82.9	A TR30	21.45	3.37	4.69	4.89	5.60	0.028880	4.21	5.09	4.34	1.24
Grande V	82.1	A TR200	44.00	3.36	5.22	5.15	6.04	0.016618	4.02	10.95	5.88	0.94
Grande V	82.1	A TR30	26.67	3.36	4.69	4.64	5.28	0.015912	3.40	7.84	5.88	0.94
Grande V	82	A TR200	43.98	3.23	5.00	5.10	6.00	0.021816	4.42	9.94	5.88	1.09
Grande V	82	A TR30	26.67	3.23	4.46	4.59	5.25	0.024487	3.94	6.77	5.88	1.17
Grande V	81	A TR200	43.20	2.54	4.69	4.16	5.13	0.004143	2.94	14.68	9.48	0.65
Grande V	81	A TR30	26.67	2.54	3.84	3.73	4.31	0.009010	3.06	8.71	8.33	0.88
Grande V	80.5		Bridge									
Grande V	80	A TR200	47.83	2.46	4.06	4.14	4.99	0.015530	4.26	11.24	11.03	1.07
Grande V	80	A TR30	26.66	2.46	3.47	3.60	4.19	0.020441	3.77	7.08	10.07	1.20
Grande V	79.99	A TR200	47.65	1.86	4.04	3.55	4.38	0.005109	2.57	18.55	11.00	0.63
Grande V	79.99	A TR30	26.67	1.86	3.45	3.09	3.69	0.005265	2.17	12.26	10.02	0.63
Grande V	79	A TR200	46.99	1.20	3.17	3.22	3.95	0.017466	3.91	12.01	8.69	1.06
Grande V	79	A TR30	27.11	1.20	2.65	2.63	3.24	0.015304	3.41	7.94	6.48	0.98
Grande V	78.99		Lat Struct									
Grande V	78	A TR200	46.93	0.84	2.98	2.23	3.23	0.003663	2.21	21.20	10.55	0.50
Grande V	78	A TR30	27.47	0.84	2.39	1.82	2.56	0.003579	1.84	14.97	10.55	0.49
Grande V	77.5		Bridge									
Grande V	77.1	A TR200	46.93	0.74	2.41	2.13	2.87	0.008477	2.99	15.68	9.66	0.75
Grande V	77.1	A TR30	27.47	0.74	1.93	1.73	2.25	0.008464	2.49	11.03	9.66	0.74
Grande V	77	A TR200	46.93	0.74	2.41	2.13	2.87	0.008506	3.00	15.67	9.66	0.75
Grande V	77	A TR30	27.47	0.74	1.93	1.73	2.25	0.008506	2.49	11.02	9.66	0.75

Reach	River Sta	Plan	Q US (m3/s)	Q Leaving Total (m3/s)	Q DS (m3/s)	Q Weir (m3/s)	Q Gates (m3/s)	Wr Top Width (m)	Weir Max Depth (m)	Weir Avg Depth (m)	Min El Weir Flow (m)	E.G. US. (m)	W.S. US. (m)	E.G. DS (m)	W.S. DS (m)
Grande V	78.99	A TR200	46.99	0.43	46.93	0.43		14.24	0.13	0.06	2.85	3.94	3.17	3.23	2.98
Grande V	78.99	A TR30	27.11	0.00	27.47	0.00					2.85	3.24	2.65	2.56	2.39

Botro Cotone e botro Secco e botro Bargingo

Stato attuale



Note of the XS's are Geo-Referenced (Geo-Ref user entered XS, Geo-Ref interpolated XS, Non Geo-Ref user entered XS, Non Geo-Ref interpolated XS)

1 cm Horiz. = 100 m 1 cm Vert. = 82 m

N.B. in grigio sono indicati gli sfioratori laterali in destra idrografica

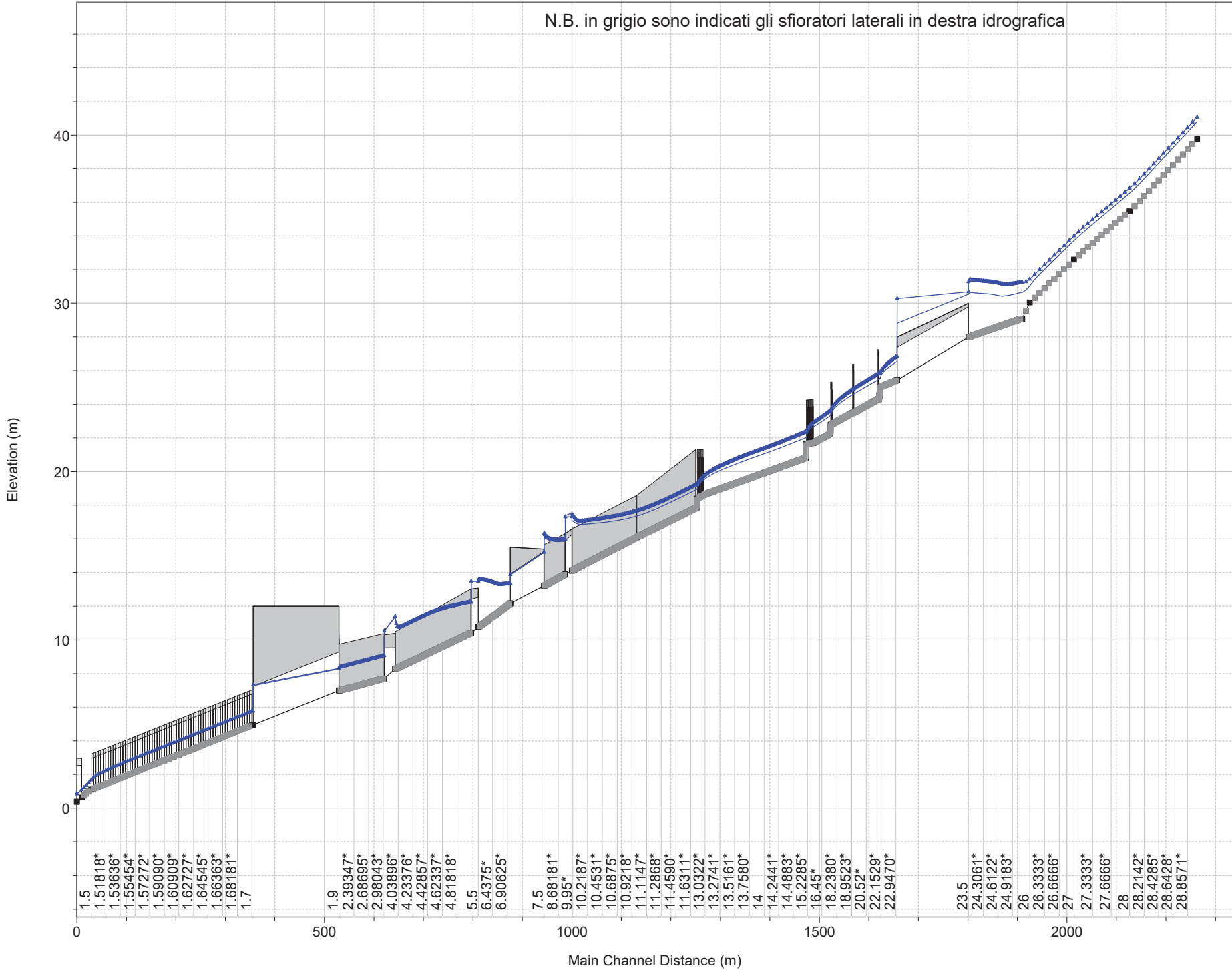
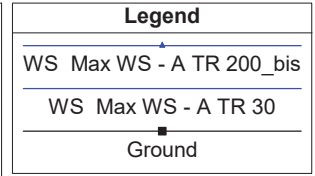

1.5
1.51818*
1.53636*
1.55454*
1.57272*
1.59090*
1.60909*
1.62727*
1.64545*
1.66363*
1.68181*
1.7

1.9
2.39347*
2.68695*
2.98043*
4.03896*
4.23376*
4.42857*
4.62337*
4.81818*
5.5
6.4375*
6.90625*

7.5
8.68181*
9.95*
10.2187*
10.4531*
10.6875*
10.9218*
11.1147*
11.2868*
11.4590*
11.6311*
13.0322*
13.2741*
13.5161*
13.7580*
14
14.2441*
14.4883*
15.2285*
16.45*
18.2380*
18.9523*
20.52*
22.1529*
22.9470*

23.5
24.3061*
24.6122*
24.9183*
26
26.3333*
26.6666*
27
27.3333*
27.6666*
28
28.2142*
28.4285*
28.6428*
28.8571*

N.B. in grigio sono indicati gli sfioratori laterali in sinistra idrografica

Legend

- WS Max WS - A TR 200_bis
- WS Max WS - A TR 30
- Ground

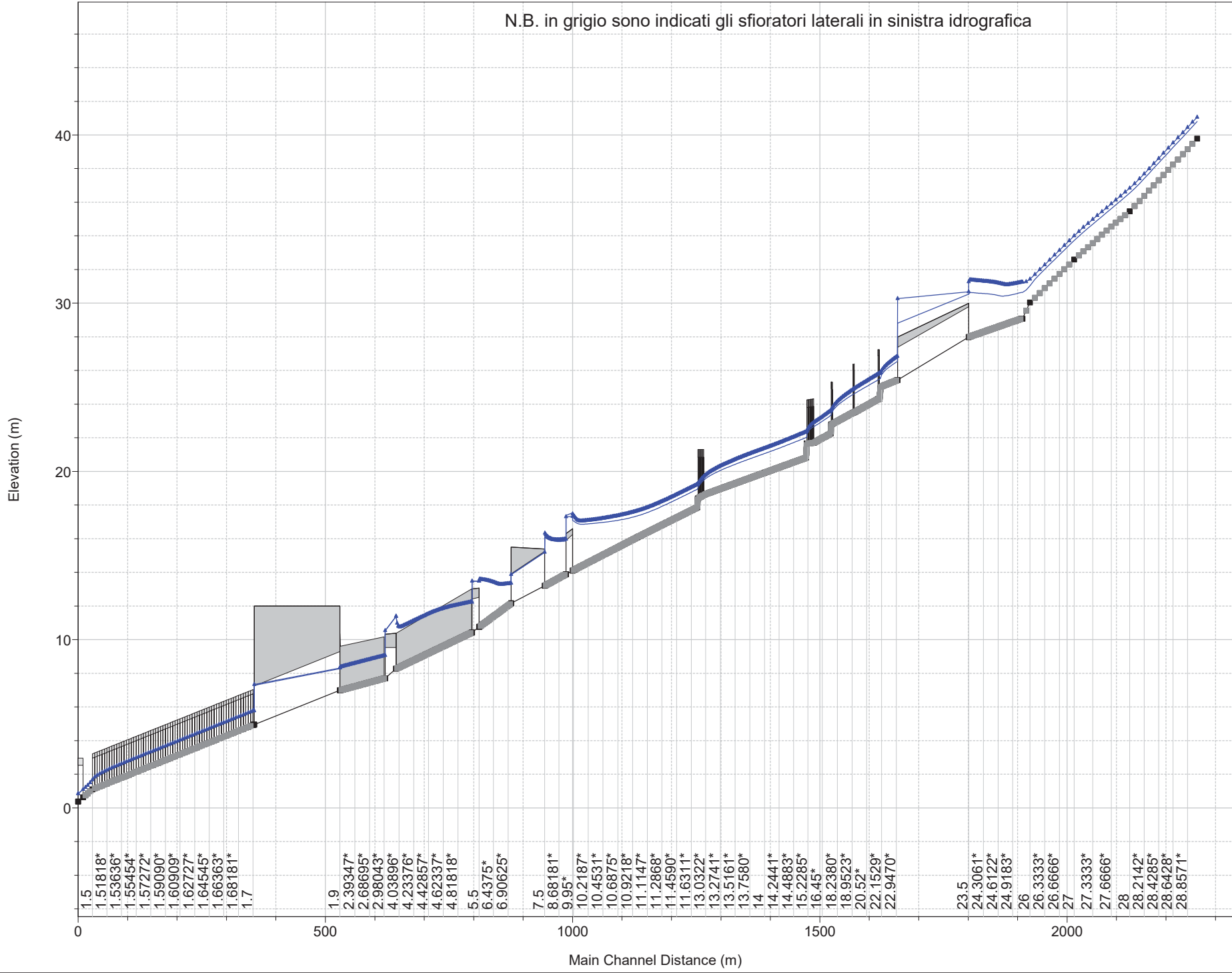

1 cm Horiz. = 102 m 1 cm Vert. = 3 m

N.B. in grigio sono indicati gli sfioratori laterali in destra idrografica

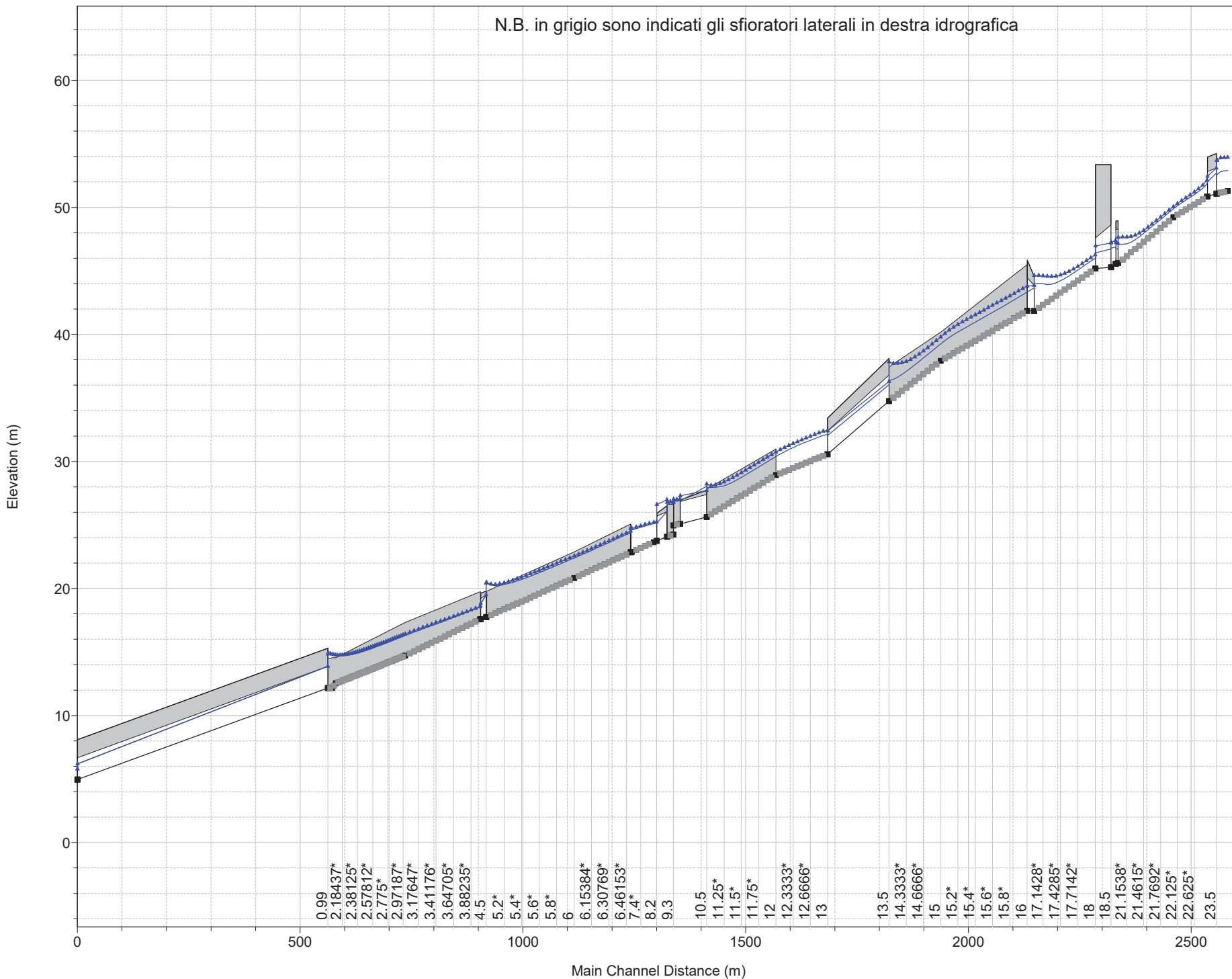
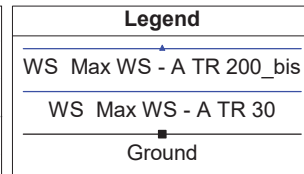

0.99
 2.18437*
 2.38125*
 2.57812*
 2.775*
 2.97187*
 3.17647*
 3.41176*
 3.64705*
 3.88235*
 4.5*
 5.2*
 5.4*
 5.6*
 5.8*
 6
 6.15384*
 6.30769*
 6.46153*
 7.4*
 8.2
 9.3
 10.5
 11.25*
 11.5*
 11.75*
 12
 12.3333*
 12.6666*
 13
 13.5
 14.3333*
 14.6666*
 15
 15.2*
 15.4*
 15.6*
 15.8
 16
 17.1428*
 17.4285*
 17.7142*
 18
 18.5
 21.1538*
 21.4615*
 21.7692*
 22.125*
 22.625*
 23.5

N.B. in grigio sono indicati gli sfioratori laterali in sinistra idrografica

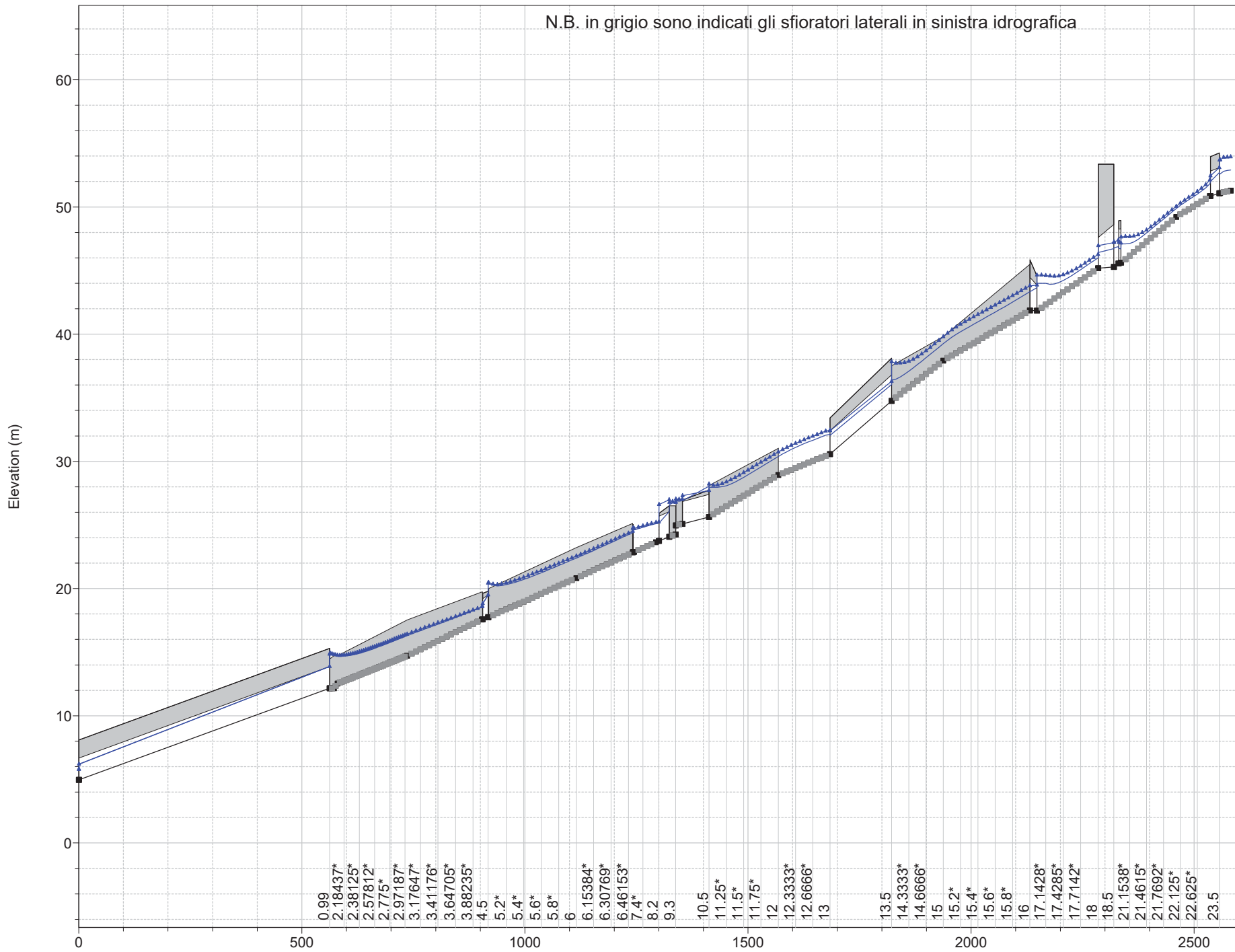
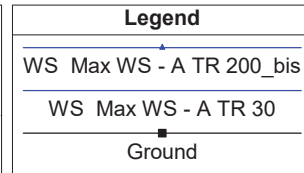

0.99
2.18437*
2.38125*
2.57812*
2.775*
2.97187*
3.17647*
3.41176*
3.64705*
3.88235*
4.5
5.2*
5.4*
5.6*
5.8*
6
6.15384*
6.30769*
6.46153*
7.4*
8.2
9.3
10.5
11.25*
11.5*
11.75*
12
12.3333*
12.6666*
13
13.5
14.3333*
14.6666*
15
15.2*
15.4*
15.6*
15.8*
16
17.1428*
17.4285*
17.7142*
18
18.5
21.1538*
21.4615*
21.7692*
22.125*
22.625*
23.5

N.B. in grigio sono indicati gli sfioratori laterali in destra idrografica

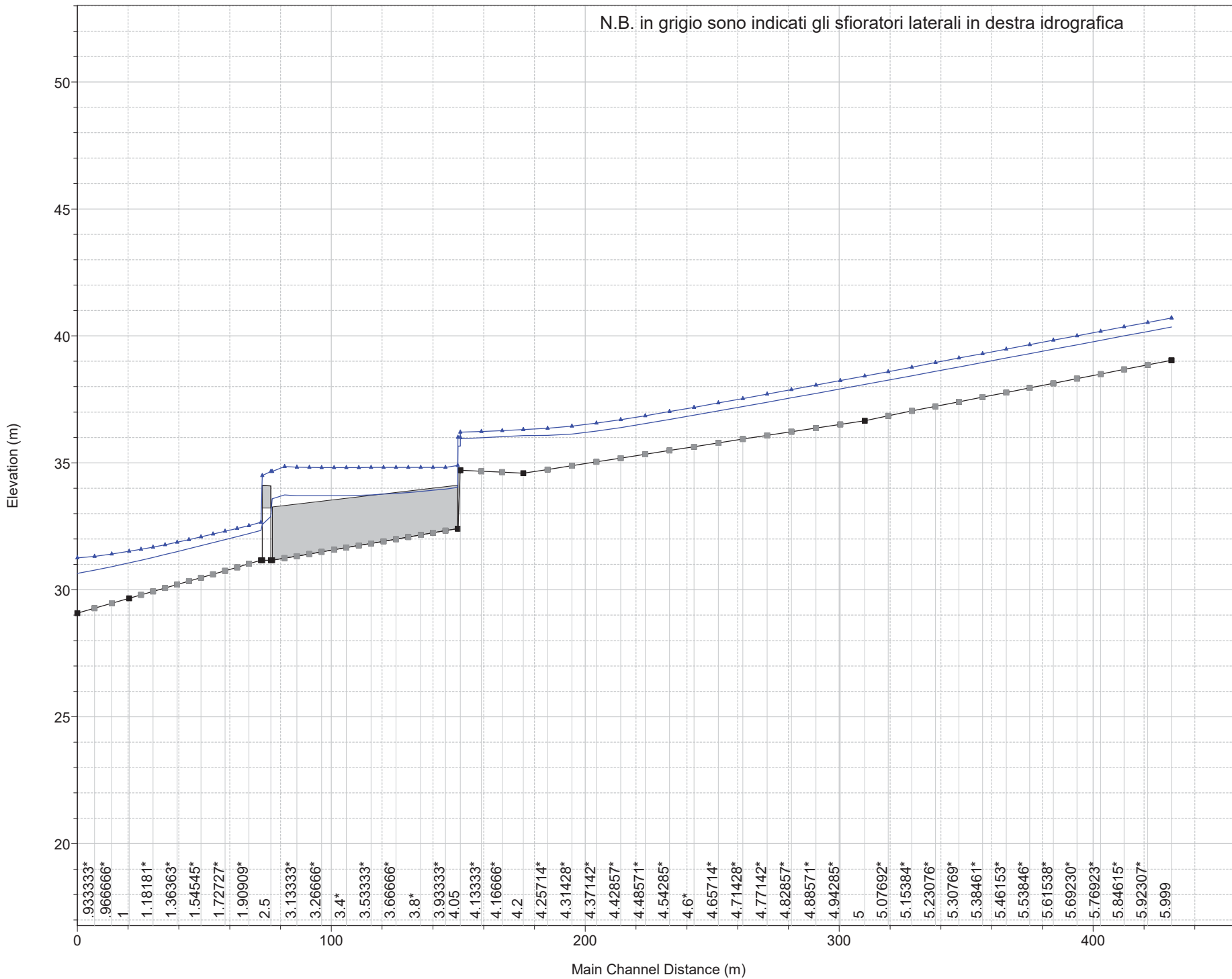

N.B. in grigio sono indicati gli sfioratori laterali in sinistra idrografica

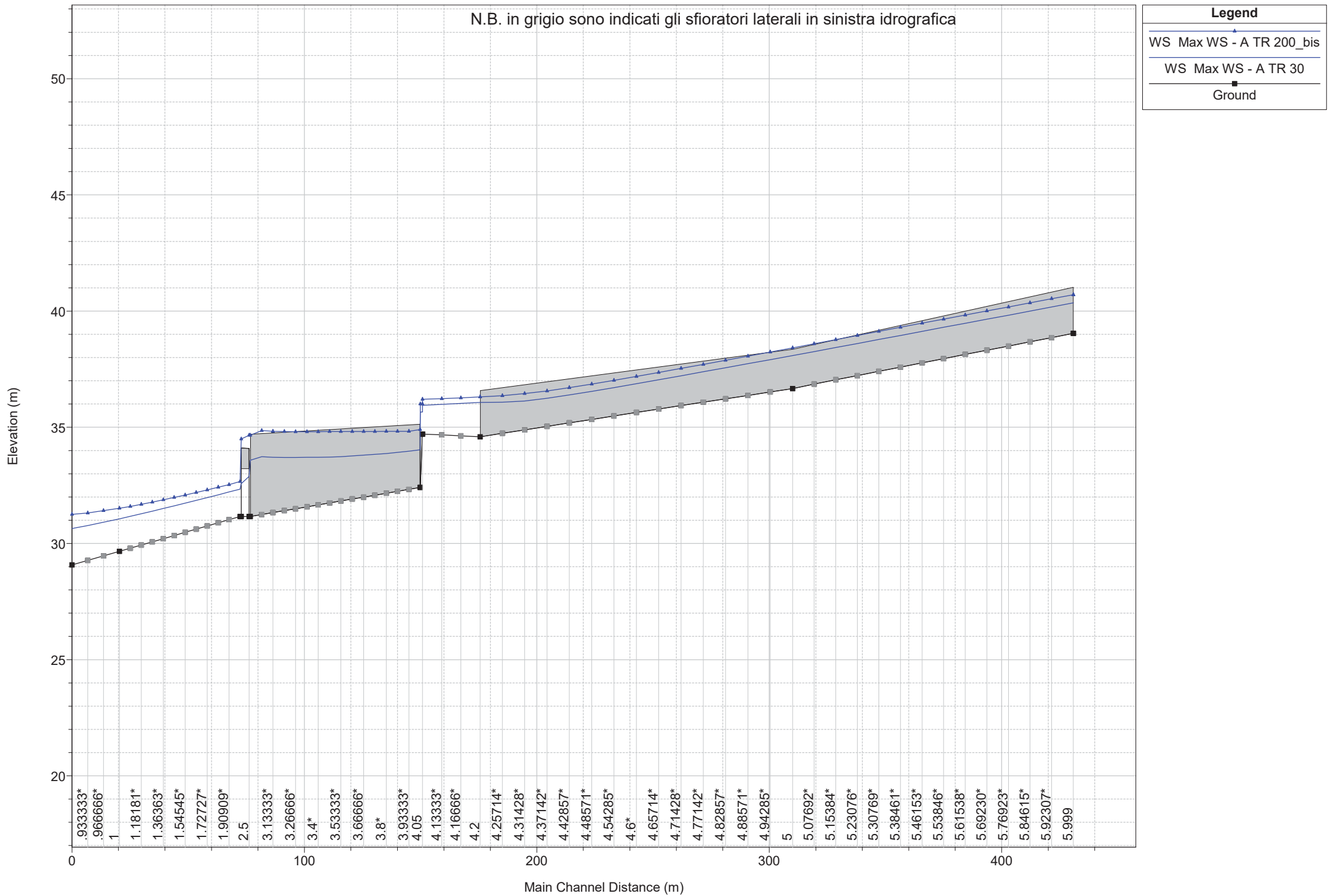

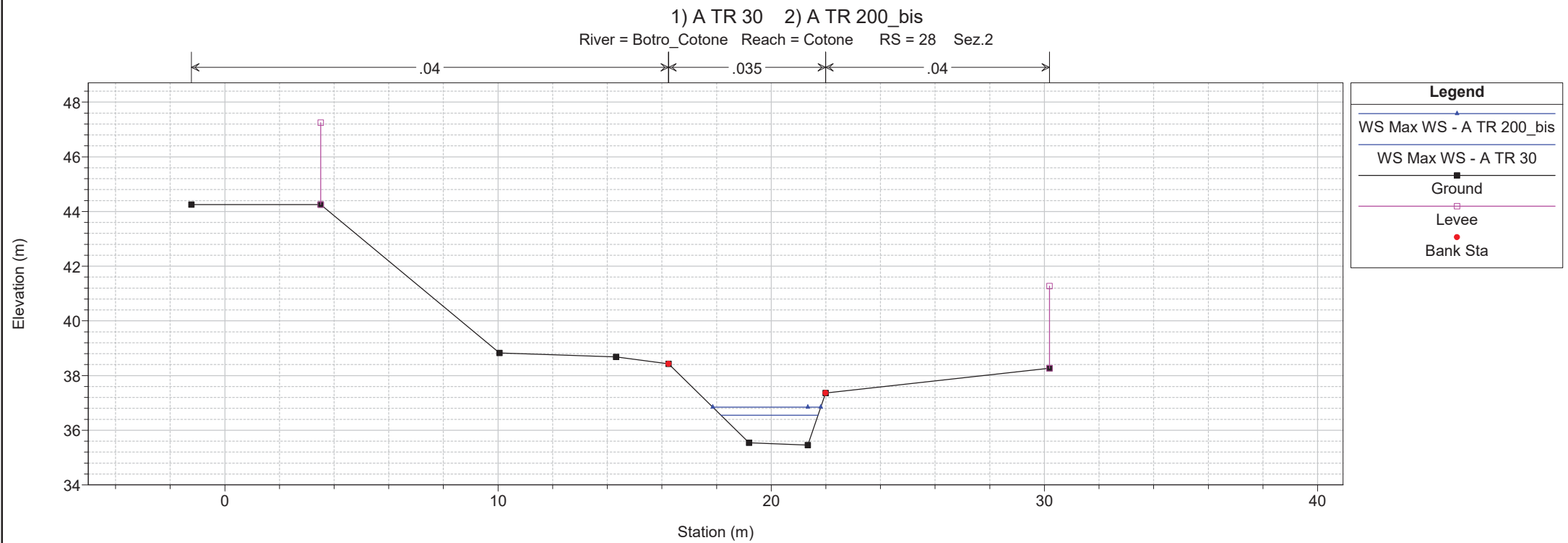
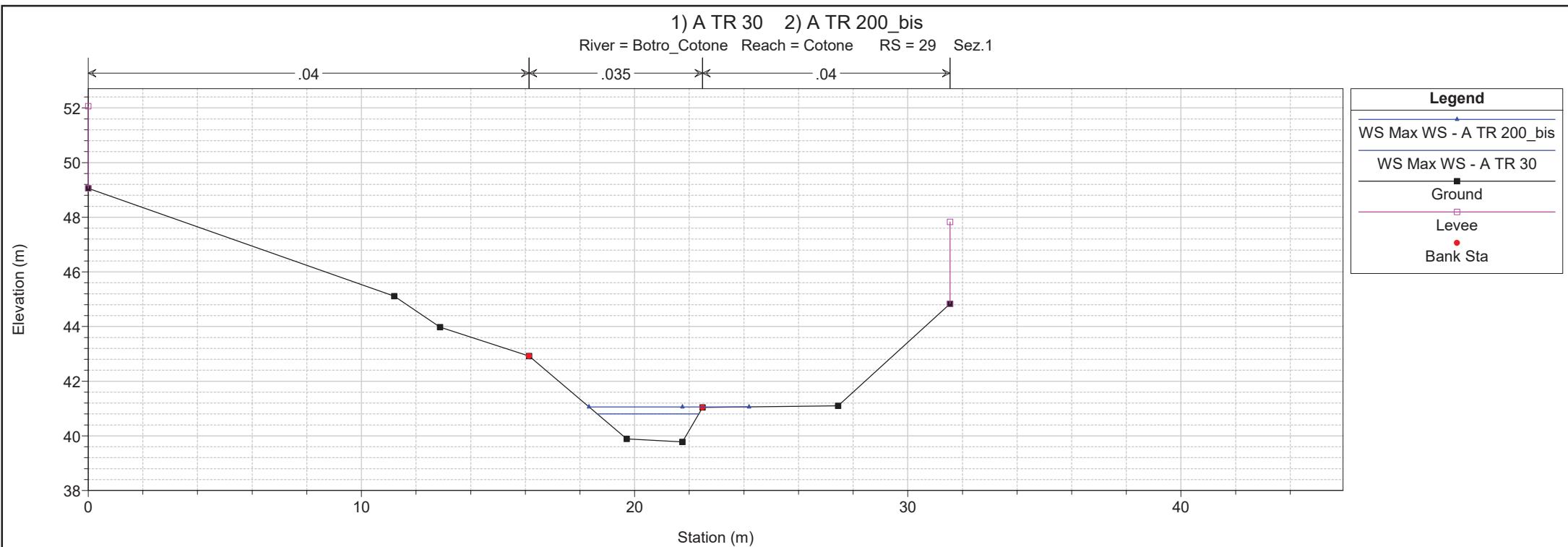

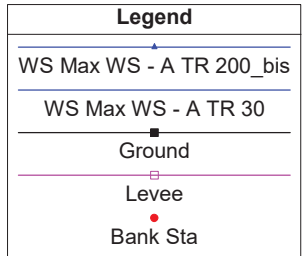
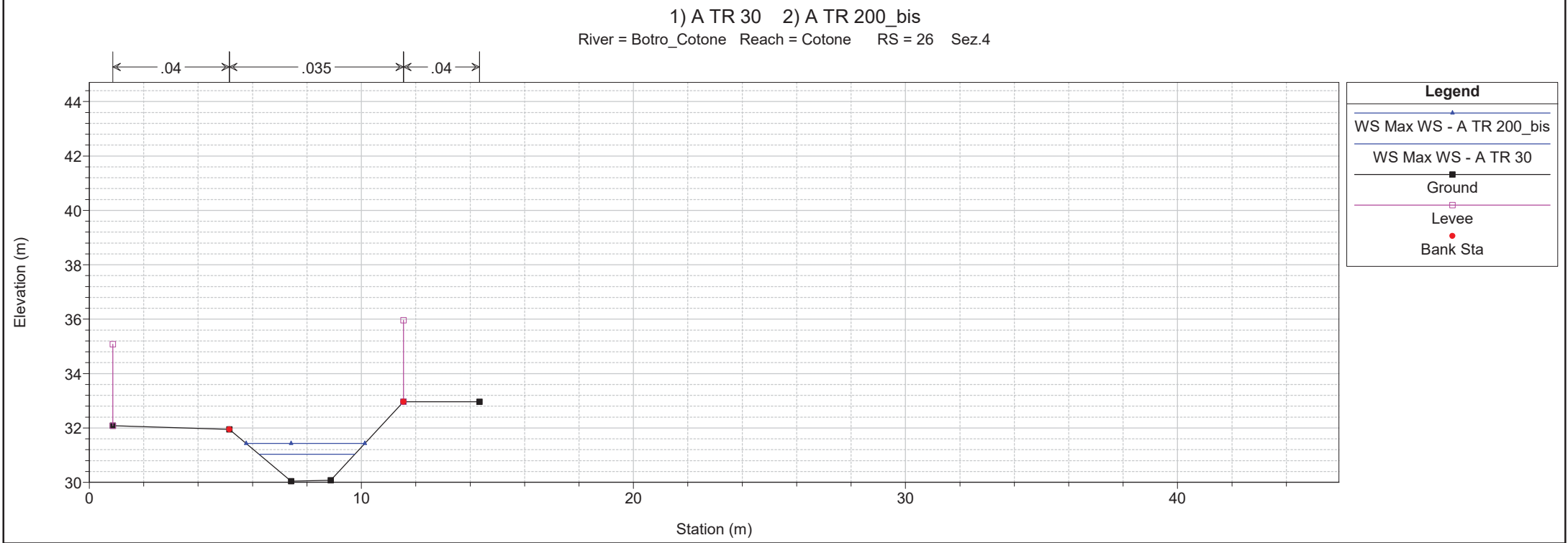
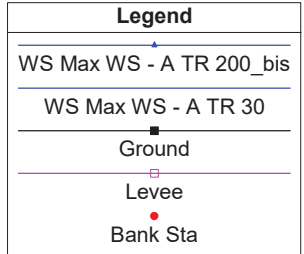
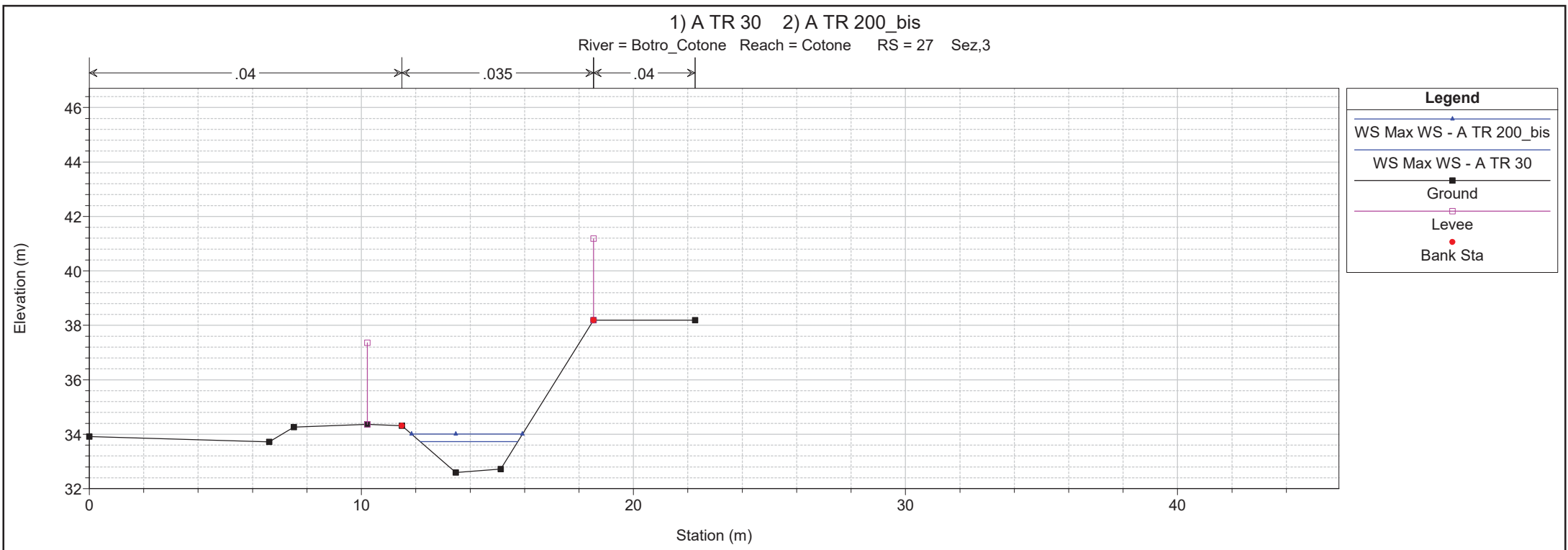

1 cm Horiz. = 2 m 1 cm Vert. = 2 m

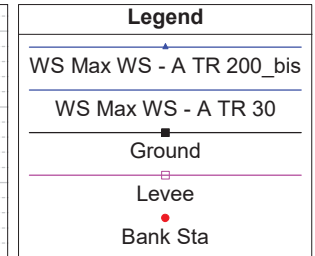
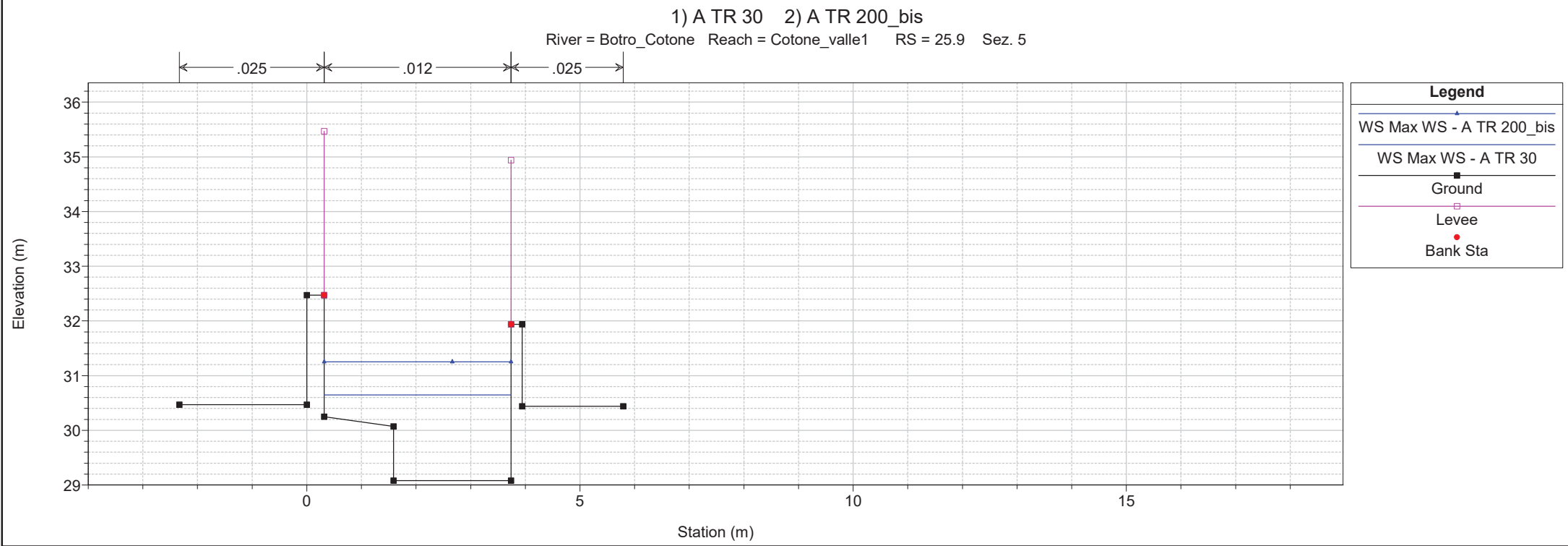
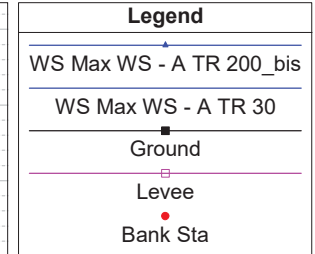
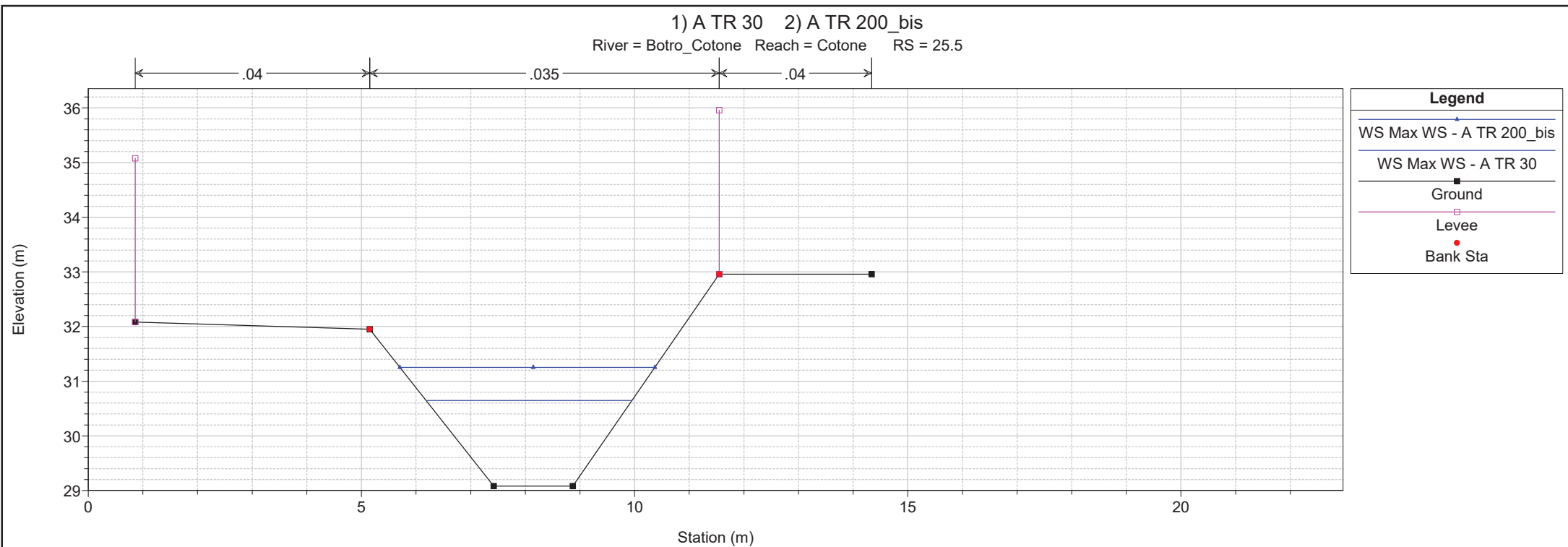

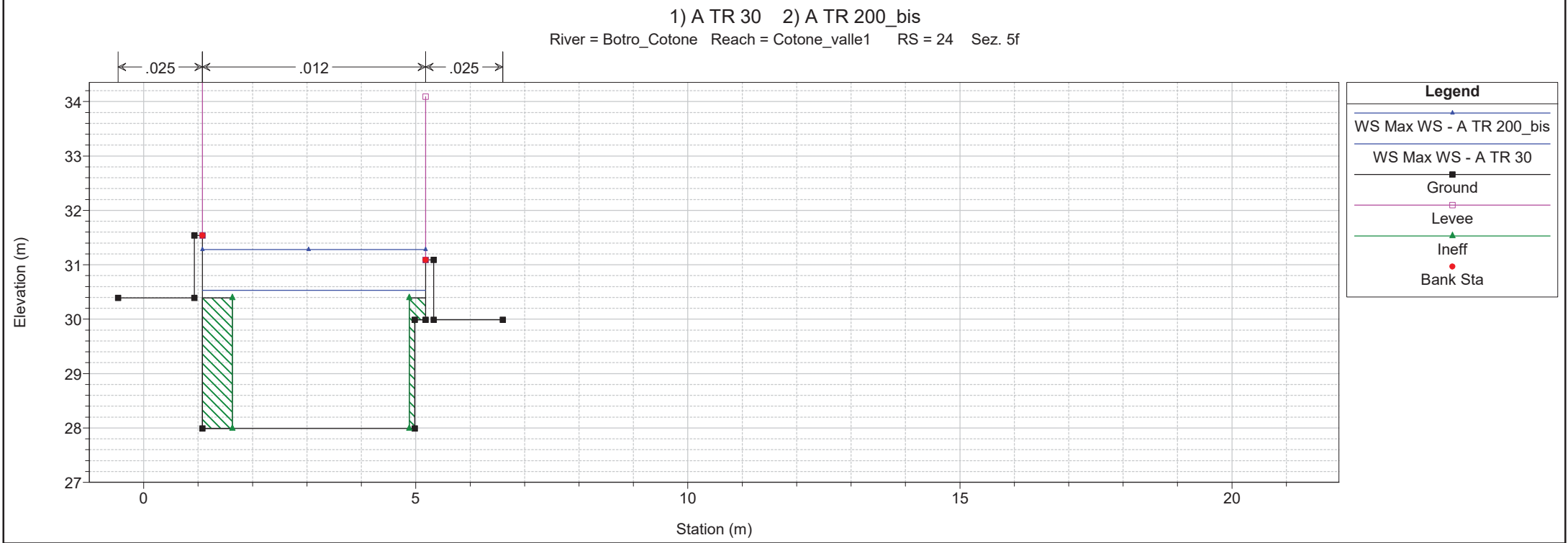
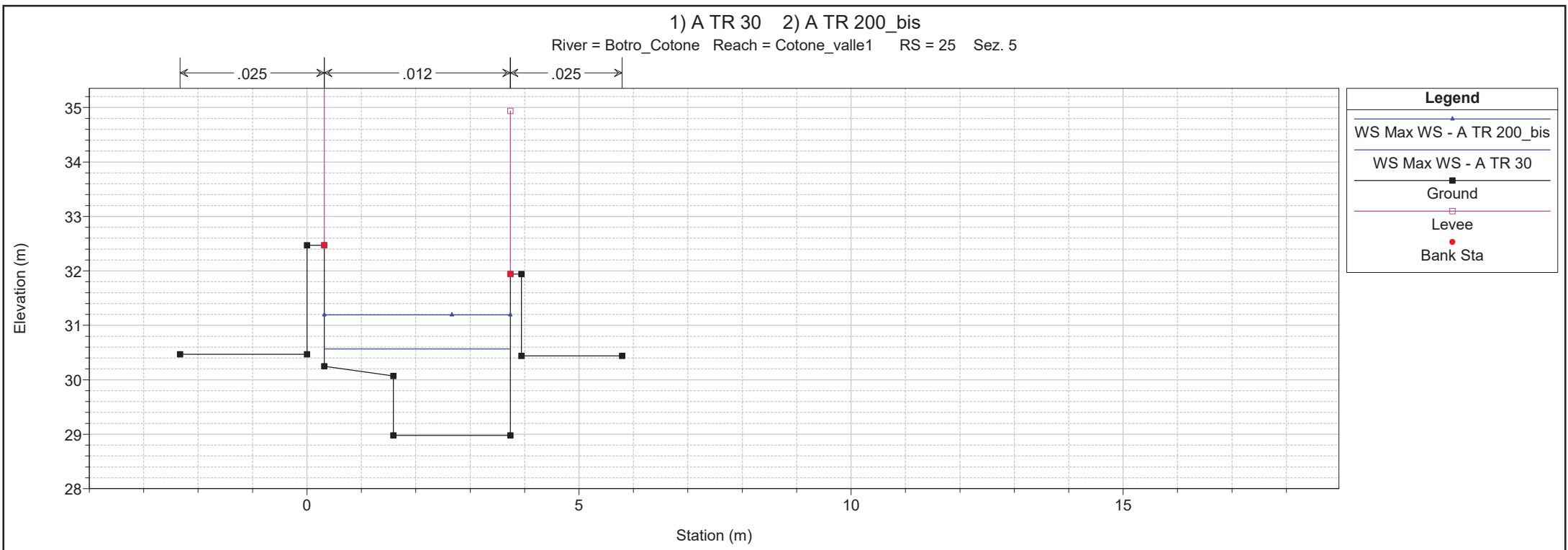

1 cm Horiz. = 1 m 1 cm Vert. = 1 m

1) A TR 30 2) A TR 200_bis
 River = Botro_Cotone Reach = Cotone_valle1 RS = 23.5 BR

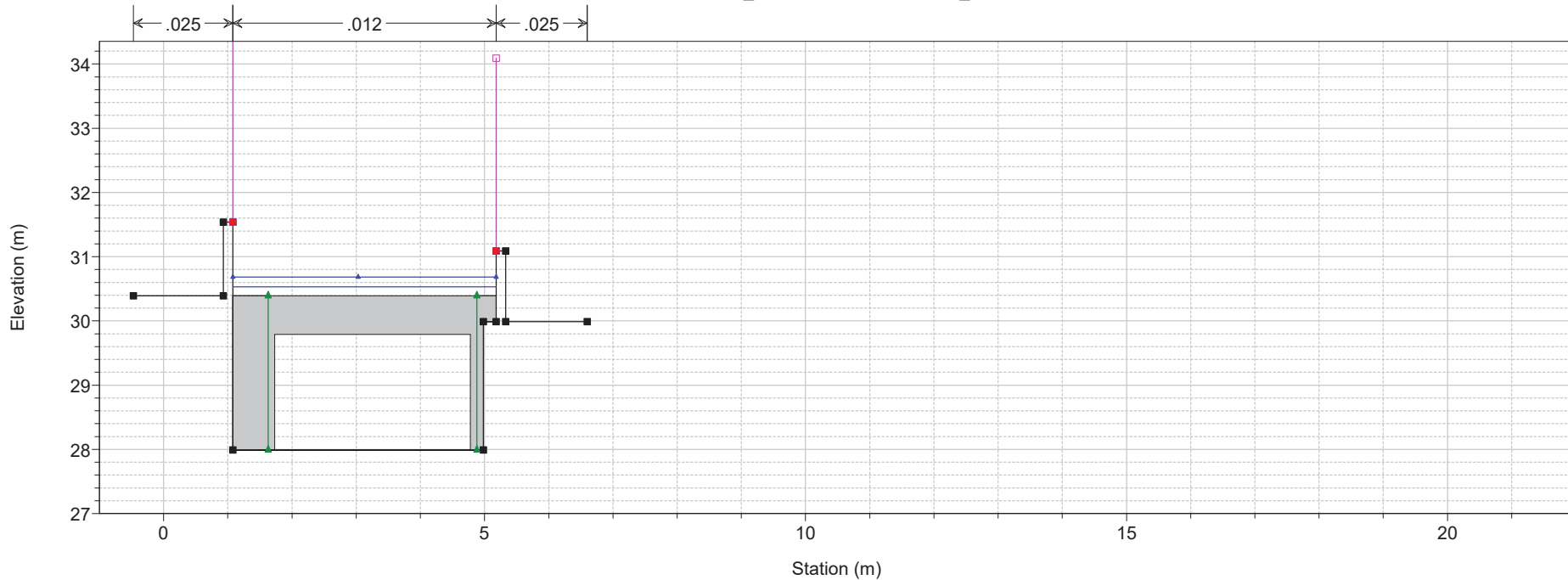

1) A TR 30 2) A TR 200_bis
 River = Botro_Cotone Reach = Cotone_valle1 RS = 23.5 BR

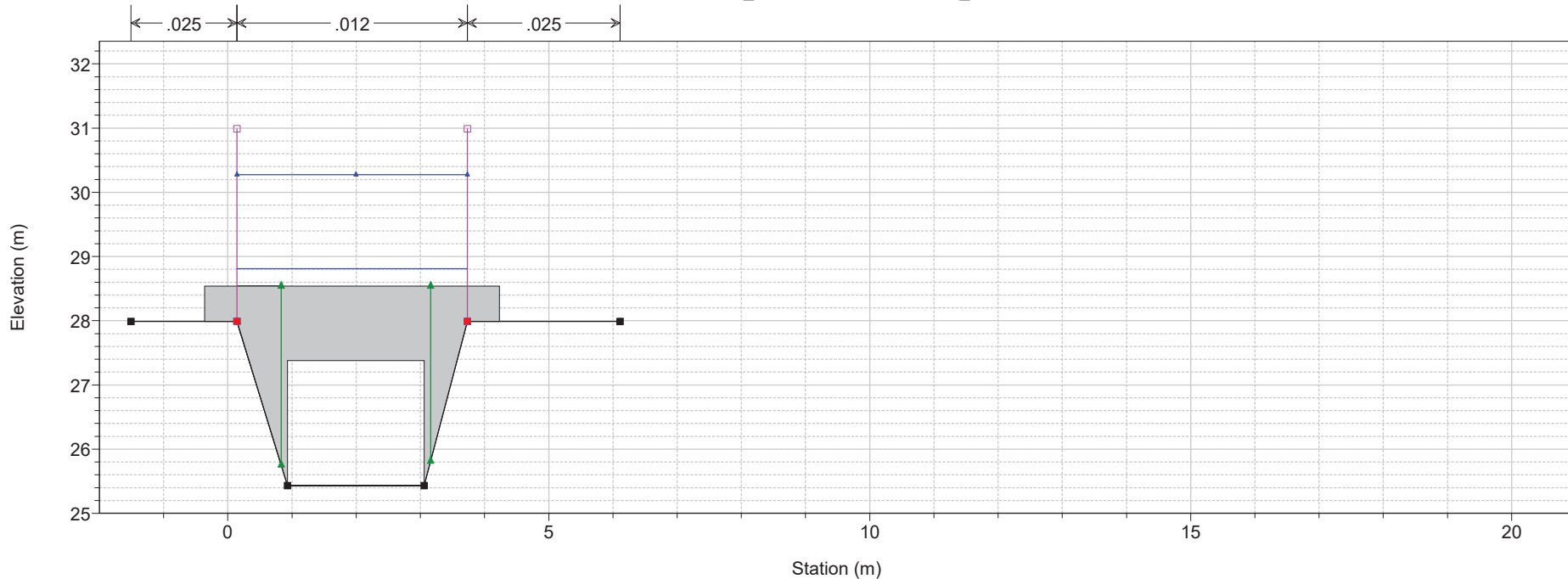

1 cm Horiz. = 1 m 1 cm Vert. = 1 m

1) A TR 30 2) A TR 200_bis
 River = Botro_Cotone Reach = Cotone_valle1 RS = 23 Sez. 5g

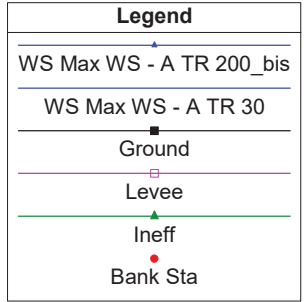
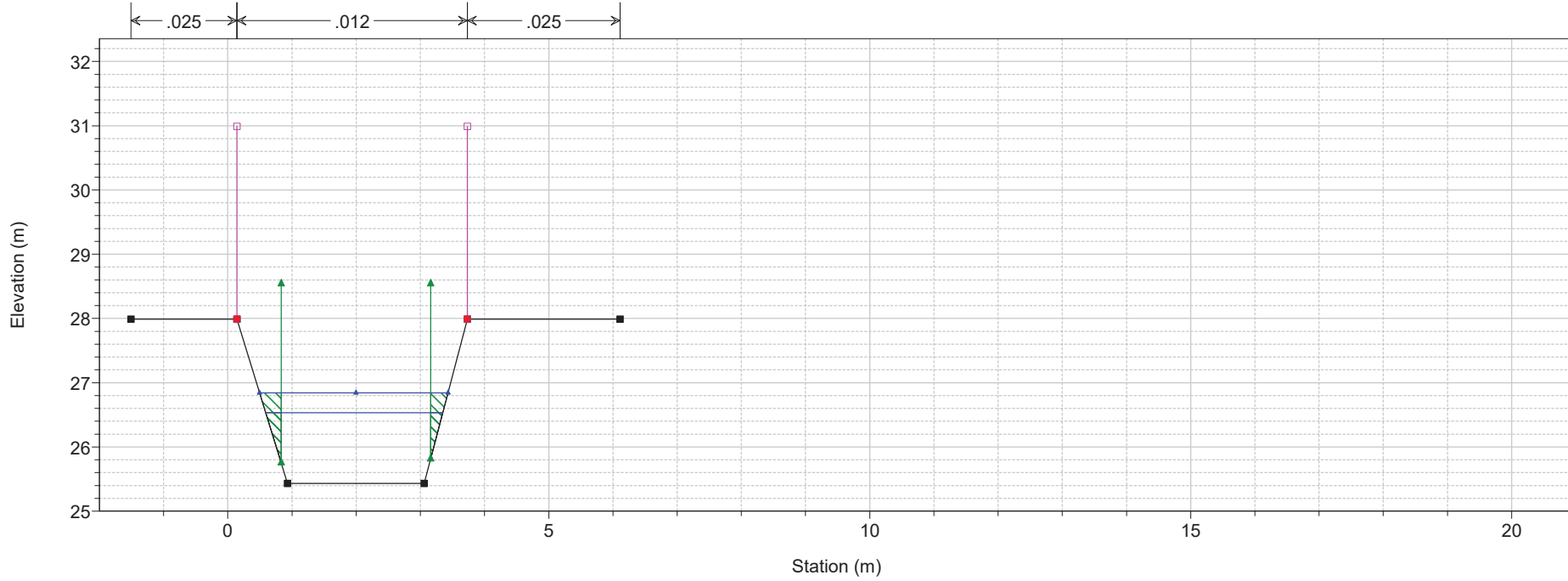

1) A TR 30 2) A TR 200_bis
 River = Botro_Cotone Reach = Cotone_valle1 RS = 22.1 Sez. 6

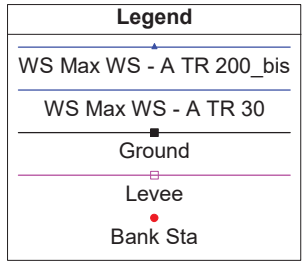
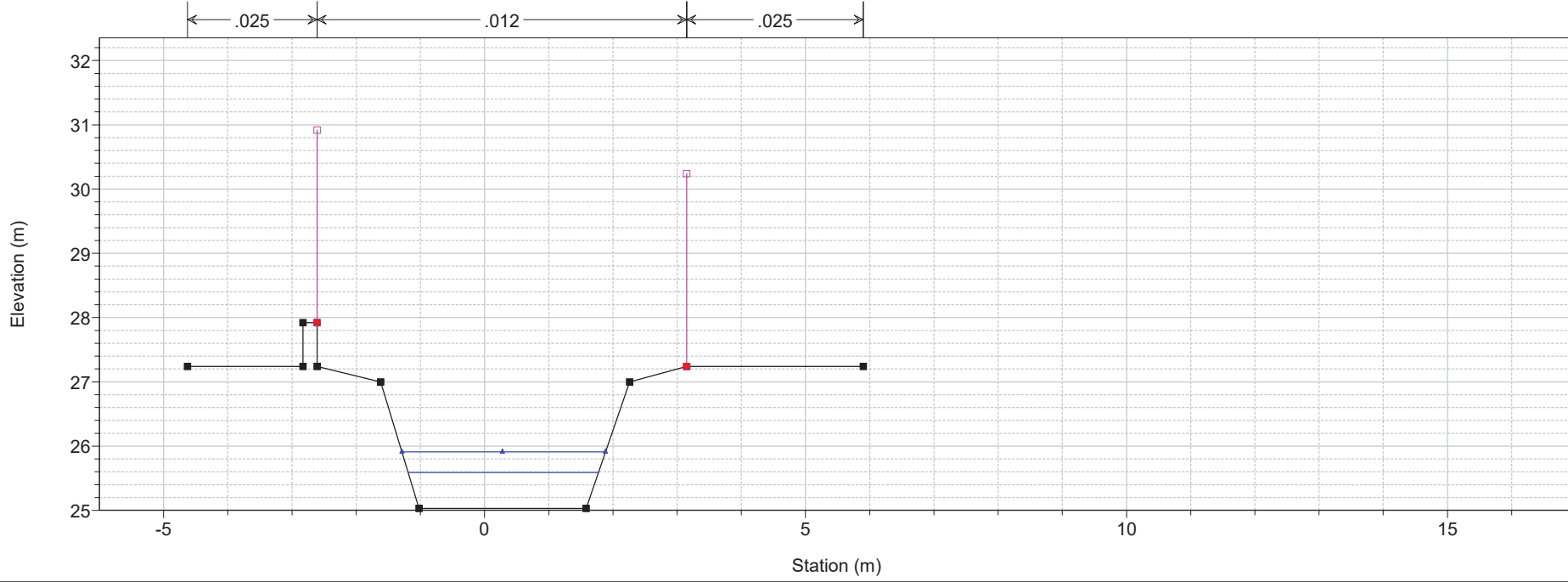

1) A TR 30 2) A TR 200_bis
 River = Botro_Cotone Reach = Cotone_valle1 RS = 22 Sez.6

← .025 → ← .012 → ← .025 →

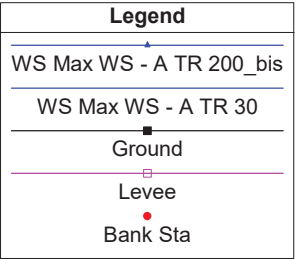
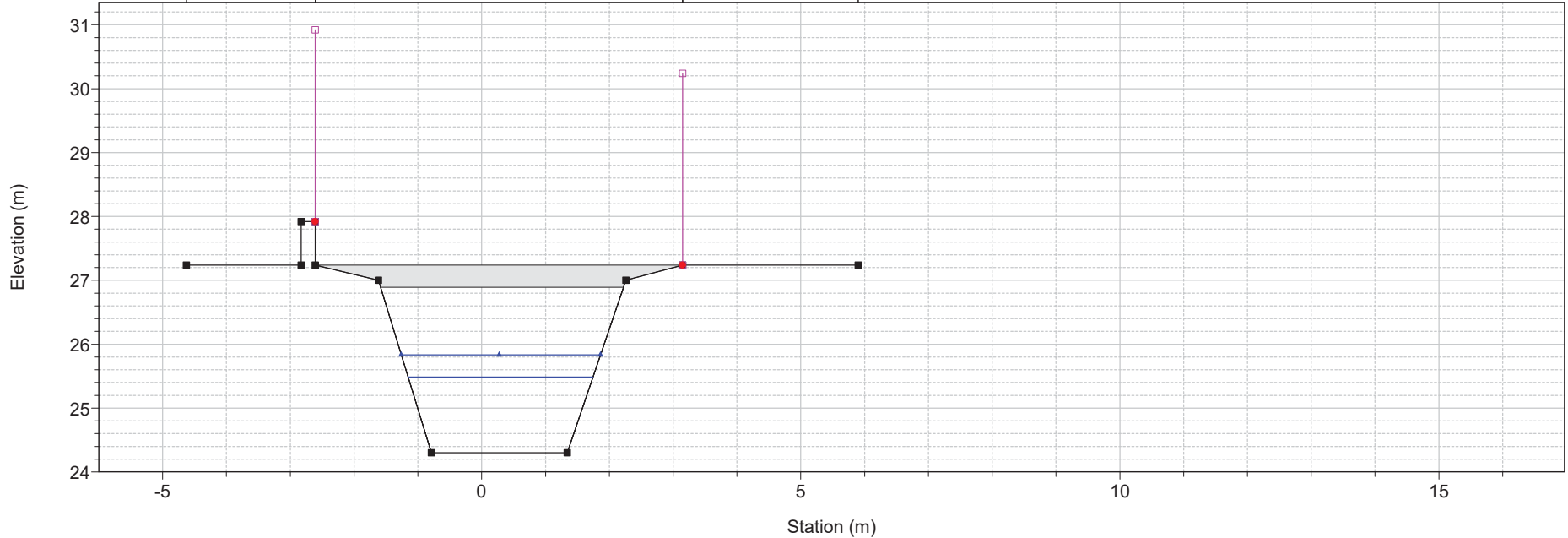

1) A TR 30 2) A TR 200_bis
 River = Botro_Cotone Reach = Cotone_valle1 RS = 21 Sez. 7

← .025 → ← .012 → ← .025 →

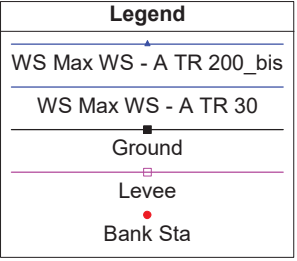
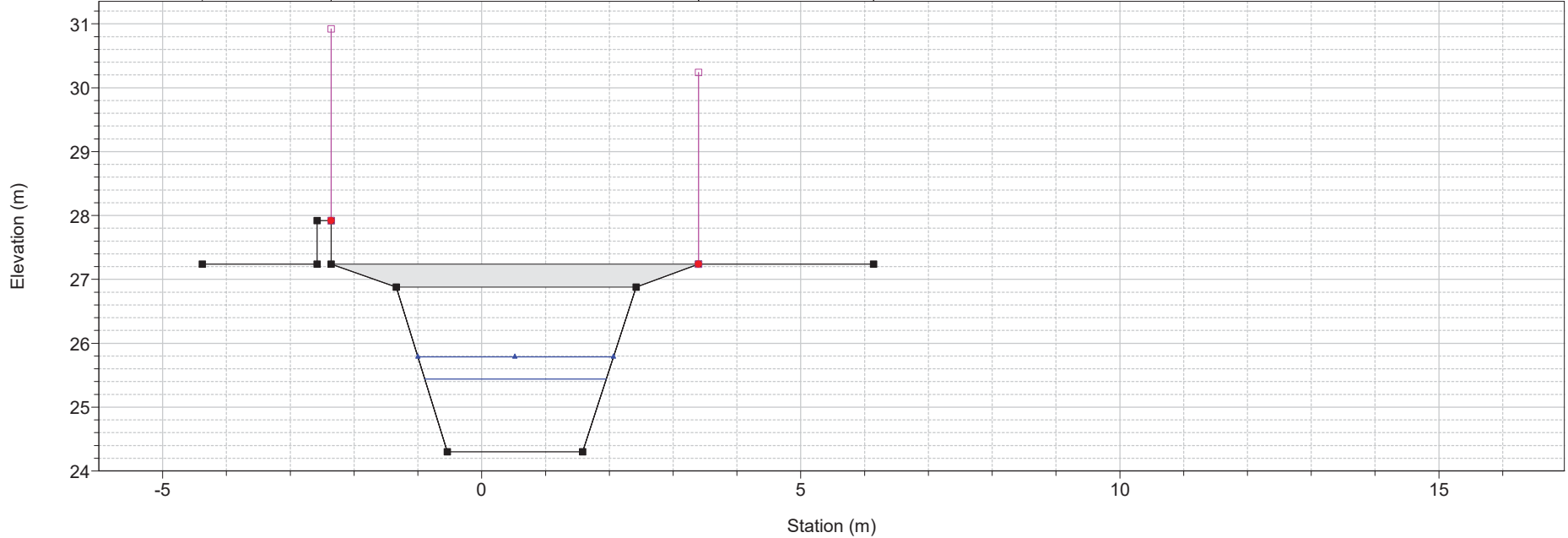

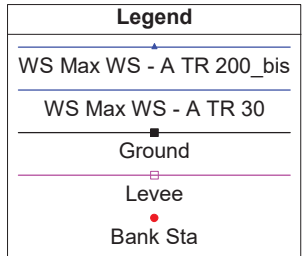
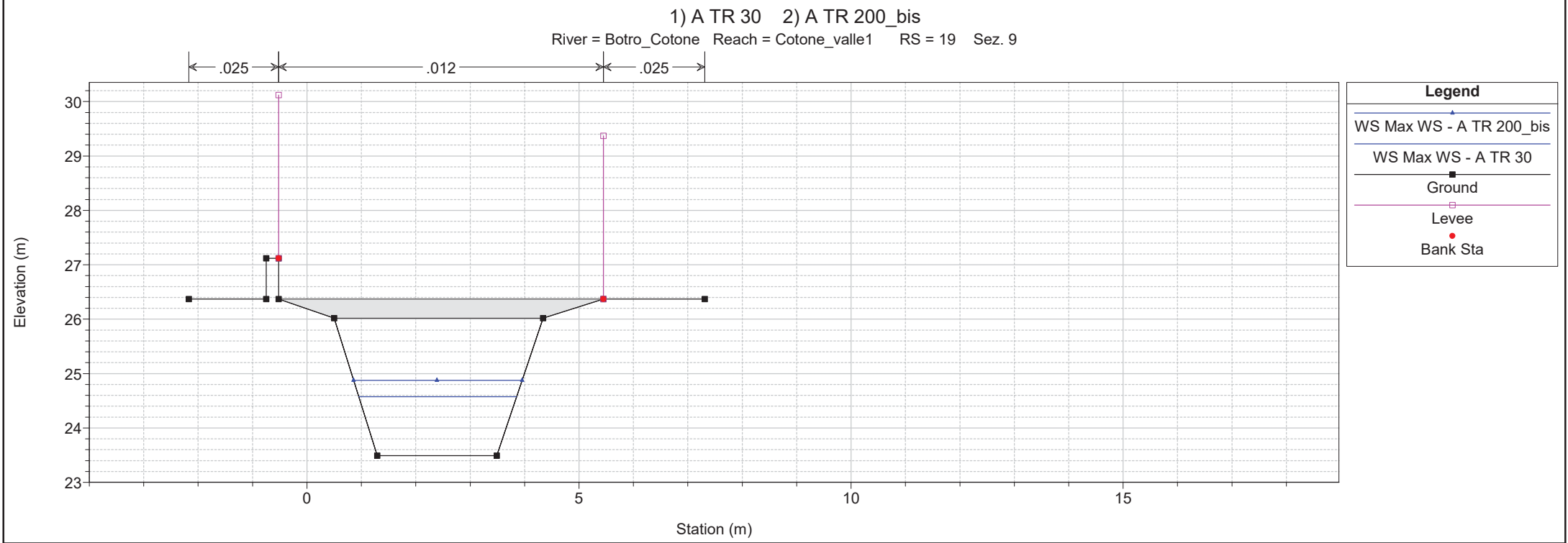
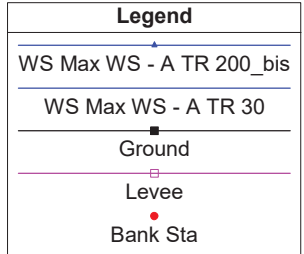
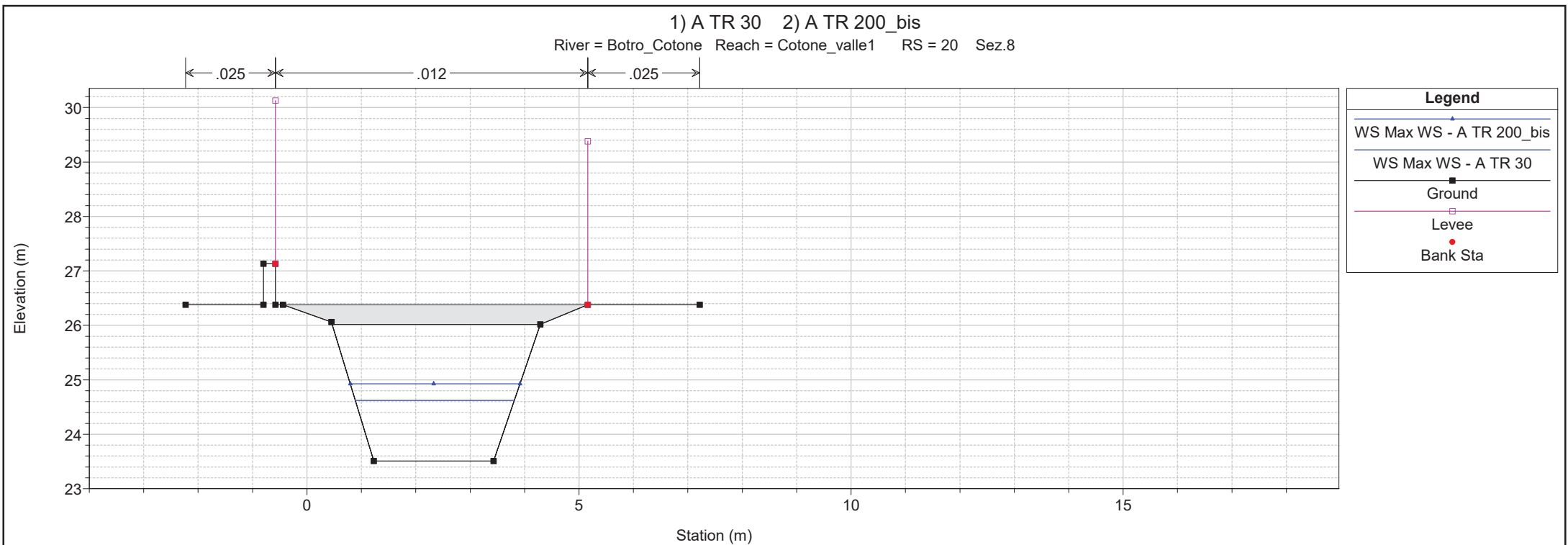

1 cm Horiz. = 1 m 1 cm Vert. = 1 m

1) A TR 30 2) A TR 200_bis
 River = Botro_Cotone Reach = Cotone_valle1 RS = 18 Sez. 10

← .025 | .012 | .025 →

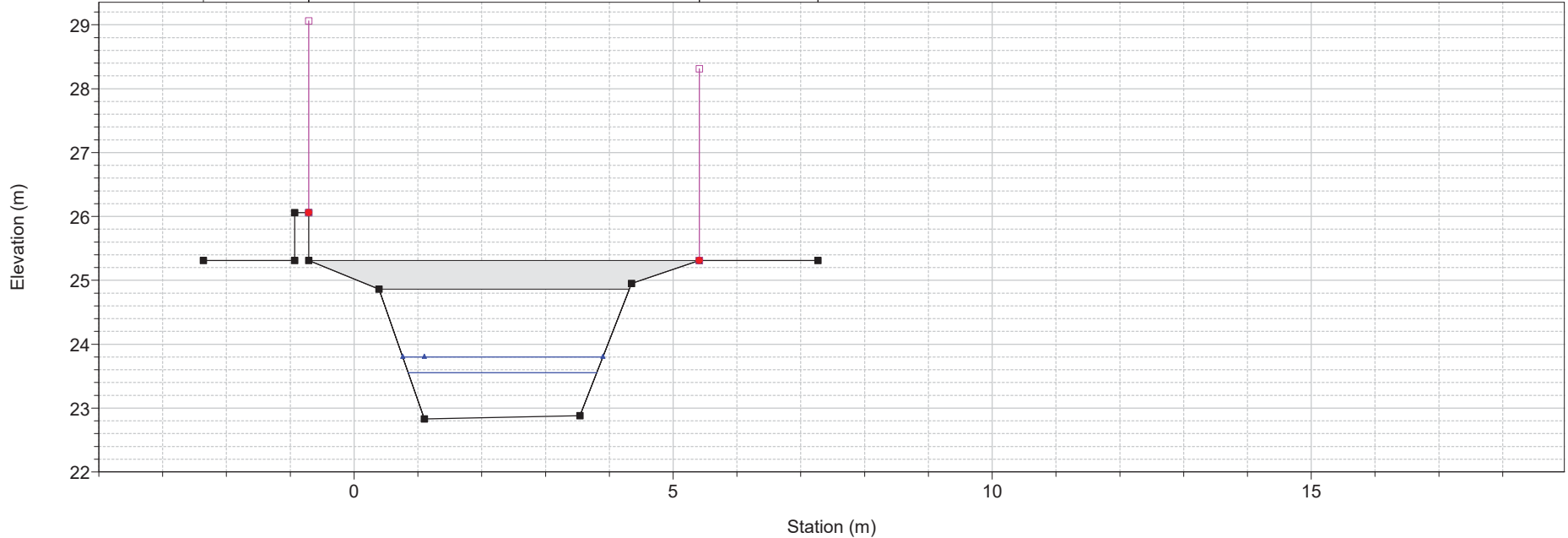

1) A TR 30 2) A TR 200_bis
 River = Botro_Cotone Reach = Cotone_valle1 RS = 17 Sez. 11

← .025 | .012 | .025 →

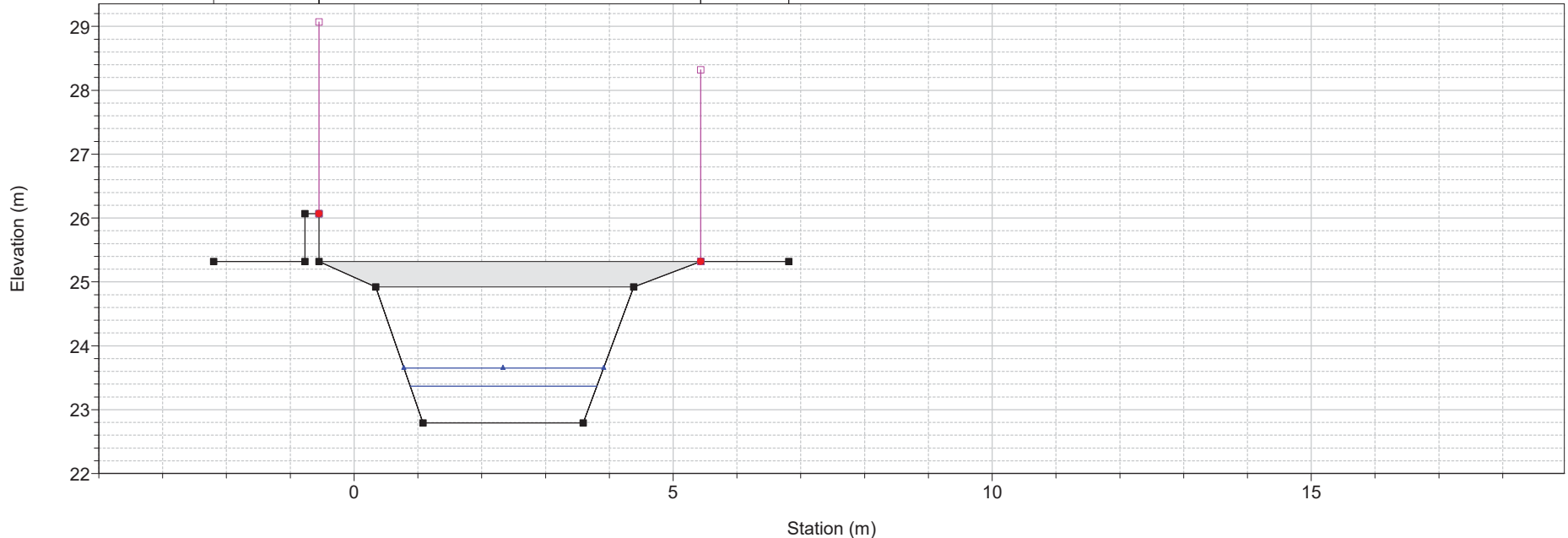

1 cm Horiz. = 1 m 1 cm Vert. = 1 m

1) A TR 30 2) A TR 200_bis
 River = Botro_Cotone Reach = Cotone_valle1 RS = 16.99 Sez. 11

← .025 → ← .012 → ← .025 →

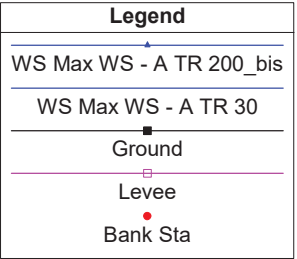
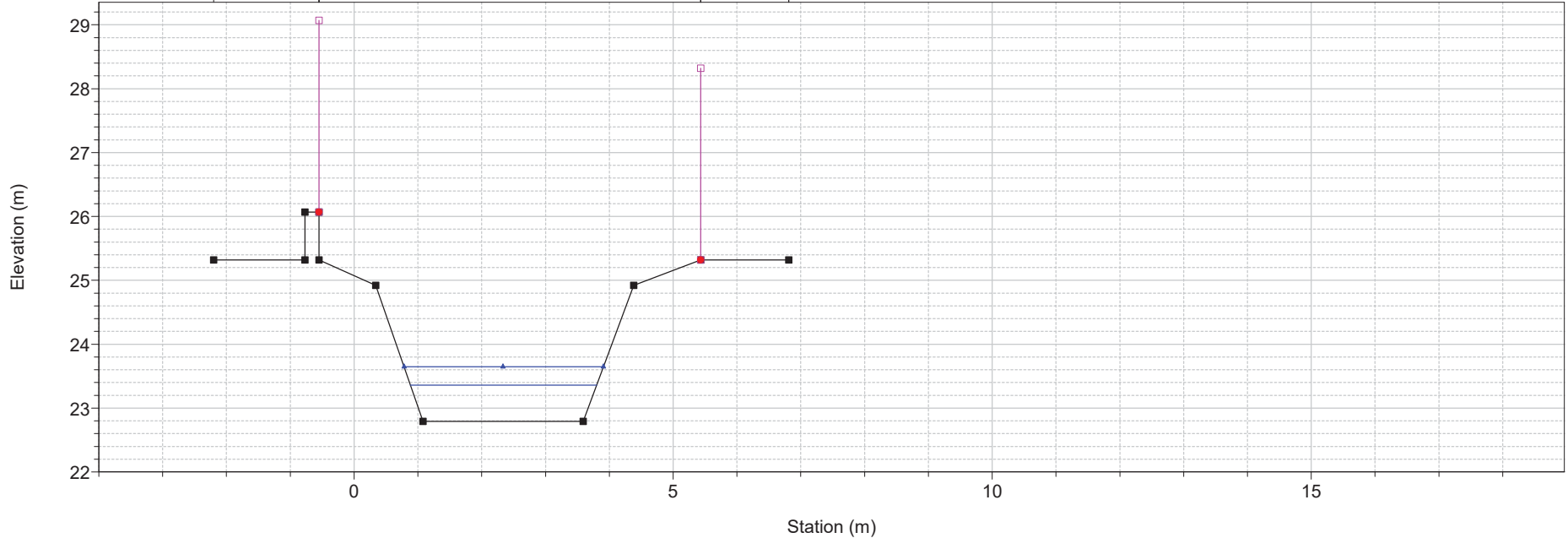

1) A TR 30 2) A TR 200_bis
 River = Botro_Cotone Reach = Cotone_valle1 RS = 16.9

← .025 → ← .012 → ← .025 →

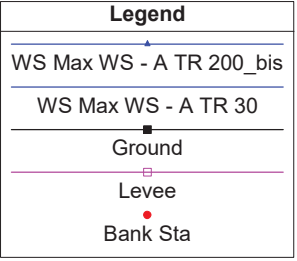
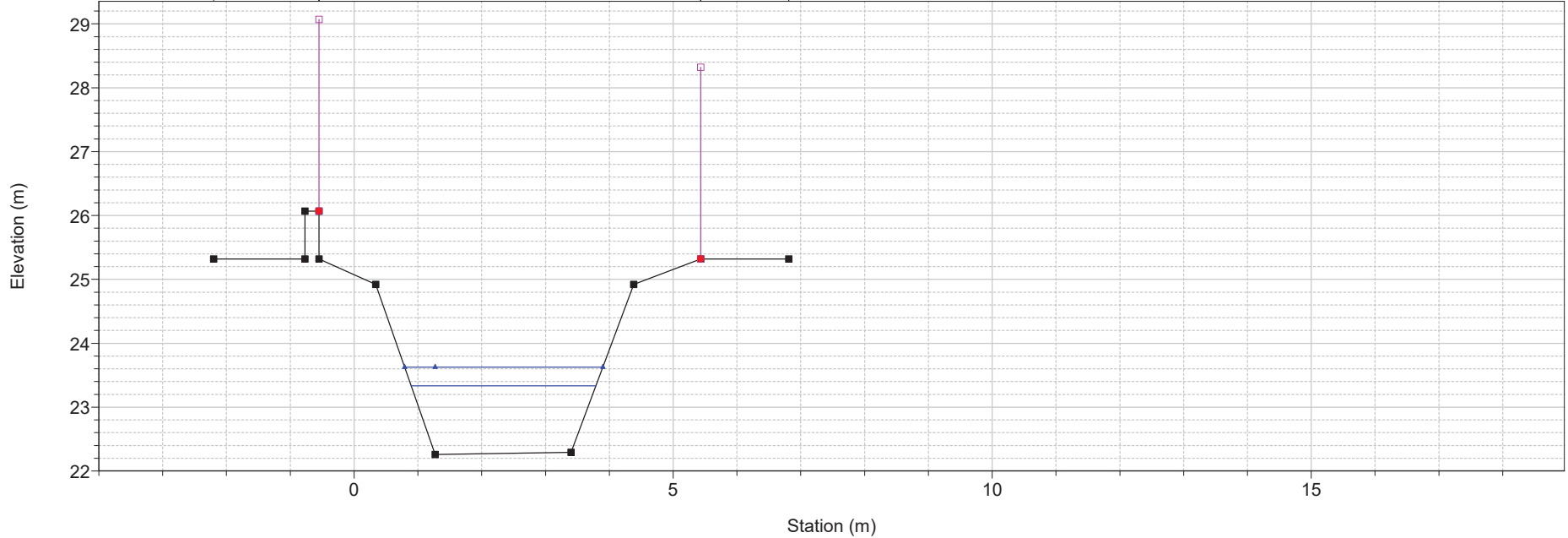

1) A TR 30 2) A TR 200_bis
 River = Botro_Cotone Reach = Cotone_valle1 RS = 16 Sez. 12

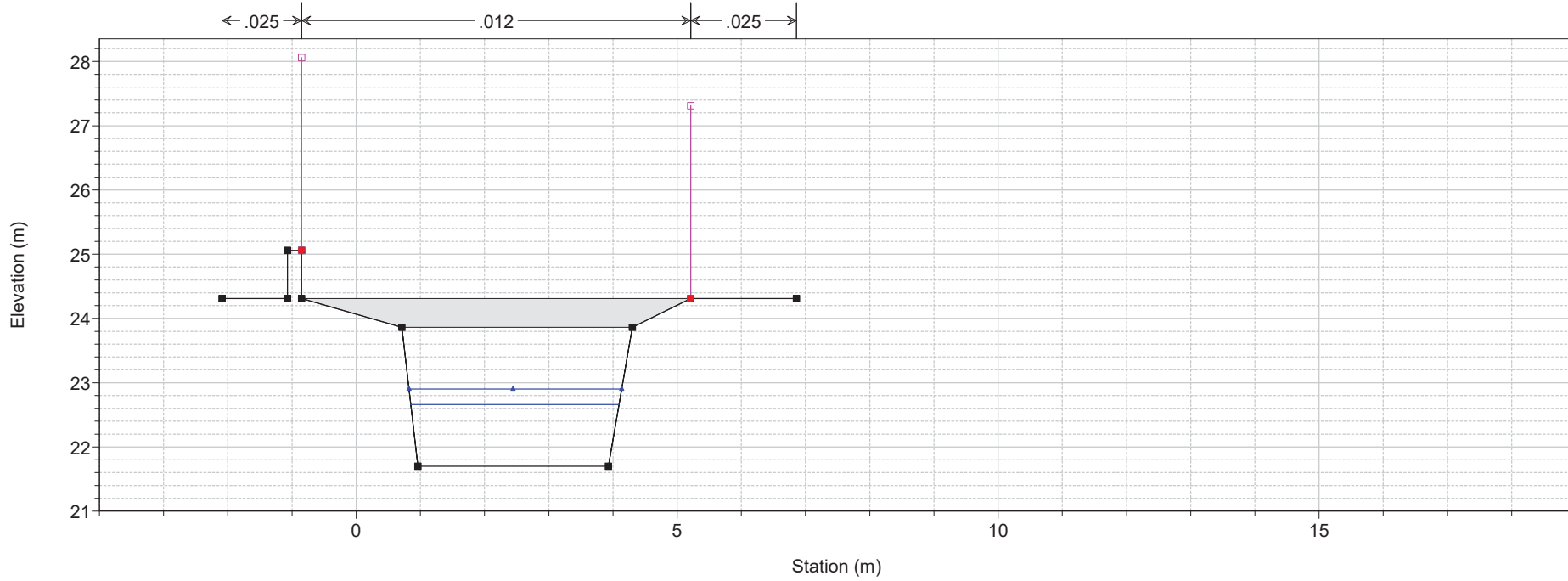

Legend

- WS Max WS - A TR 200_bis
- WS Max WS - A TR 30
- Ground
- Levee
- Bank Sta

1) A TR 30 2) A TR 200_bis
 River = Botro_Cotone Reach = Cotone_valle1 RS = 15.1 Sez.13

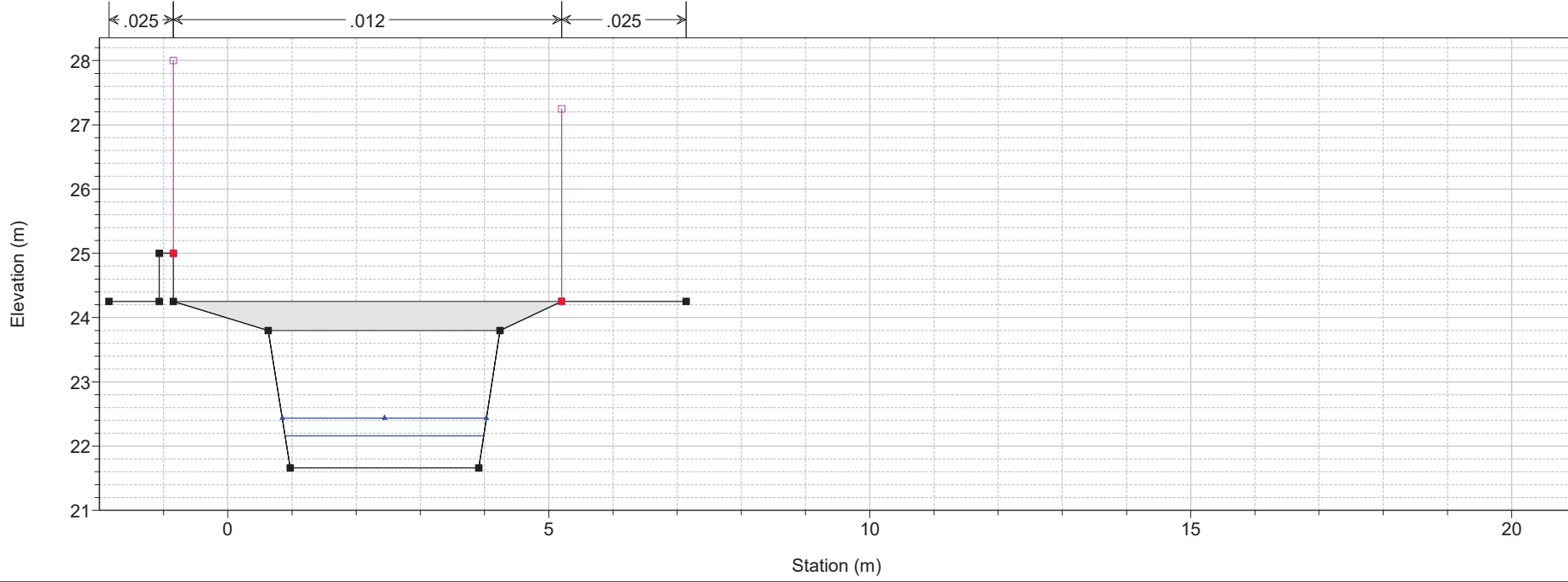

Legend

- WS Max WS - A TR 200_bis
- WS Max WS - A TR 30
- Ground
- Levee
- Bank Sta

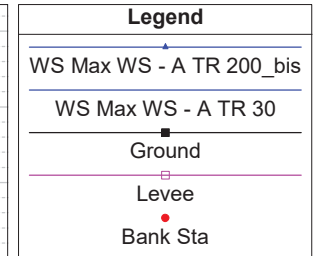
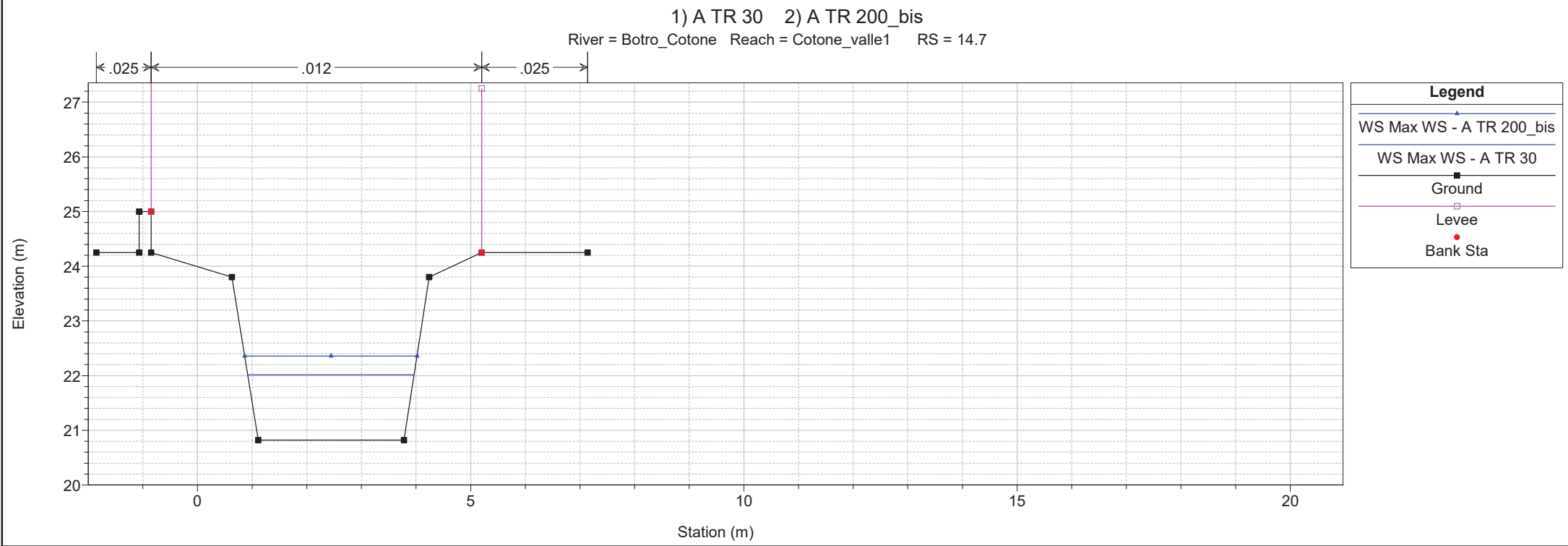
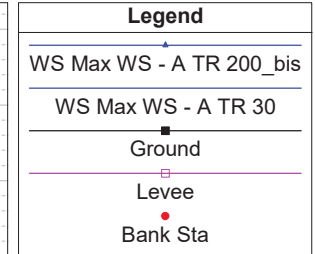
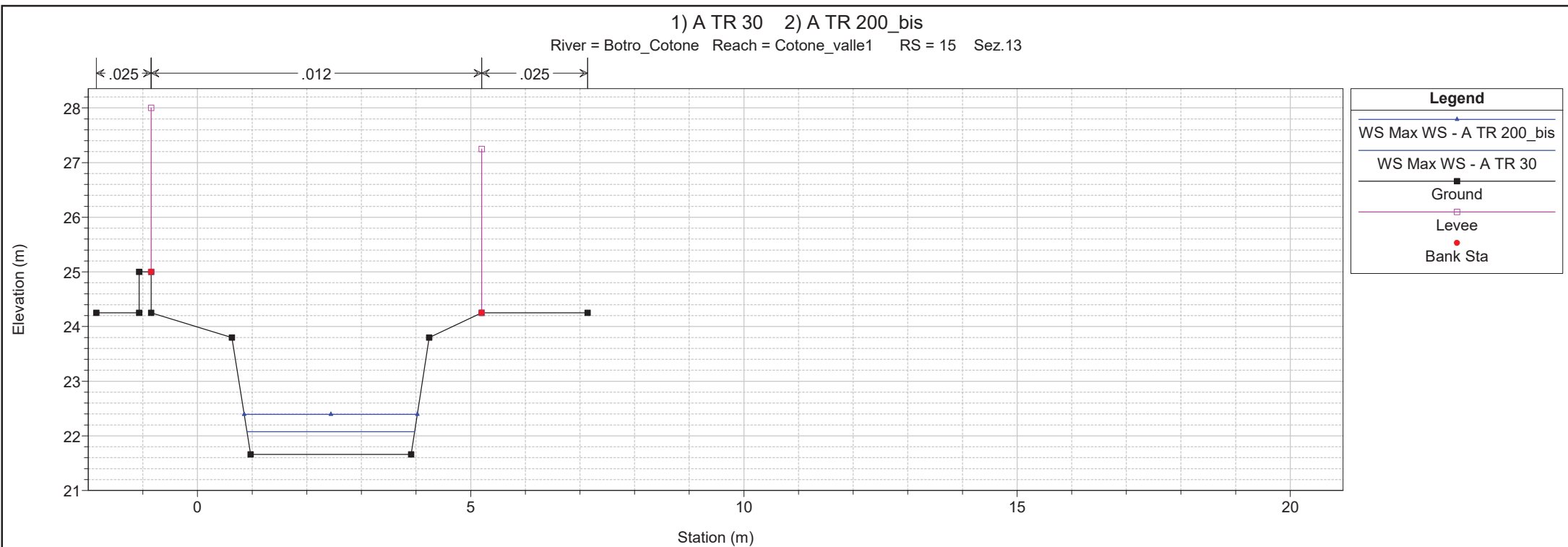

1 cm Horiz. = 1 m 1 cm Vert. = 1 m

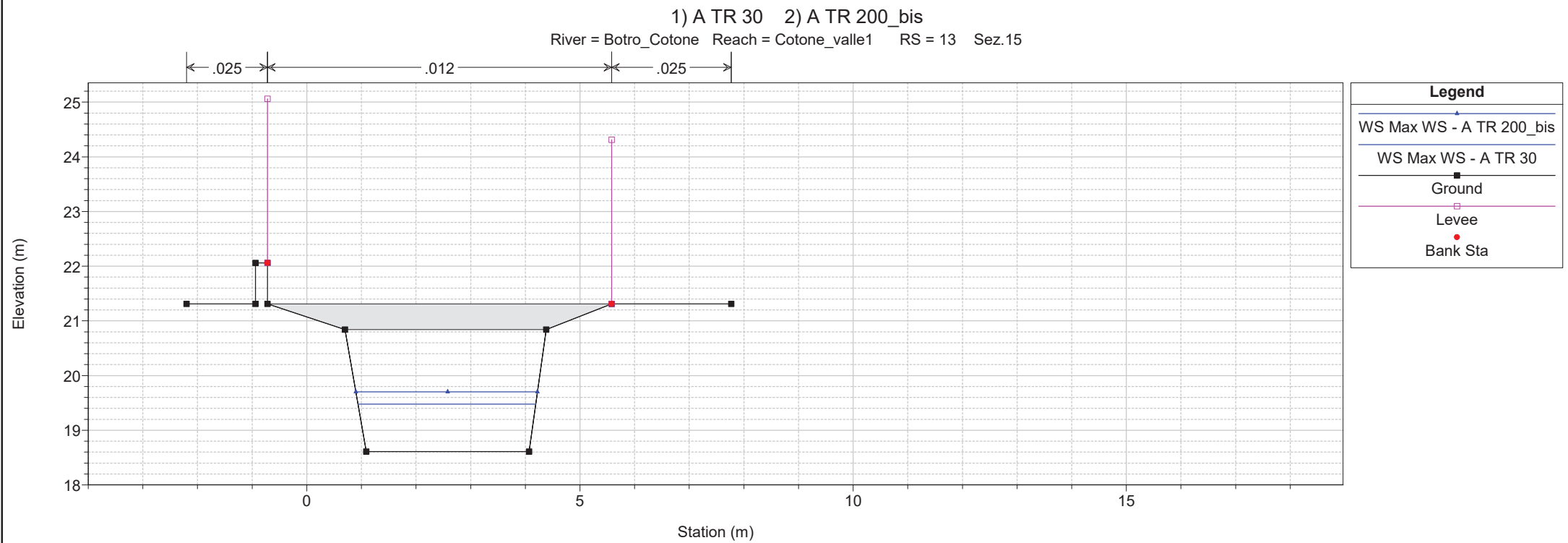
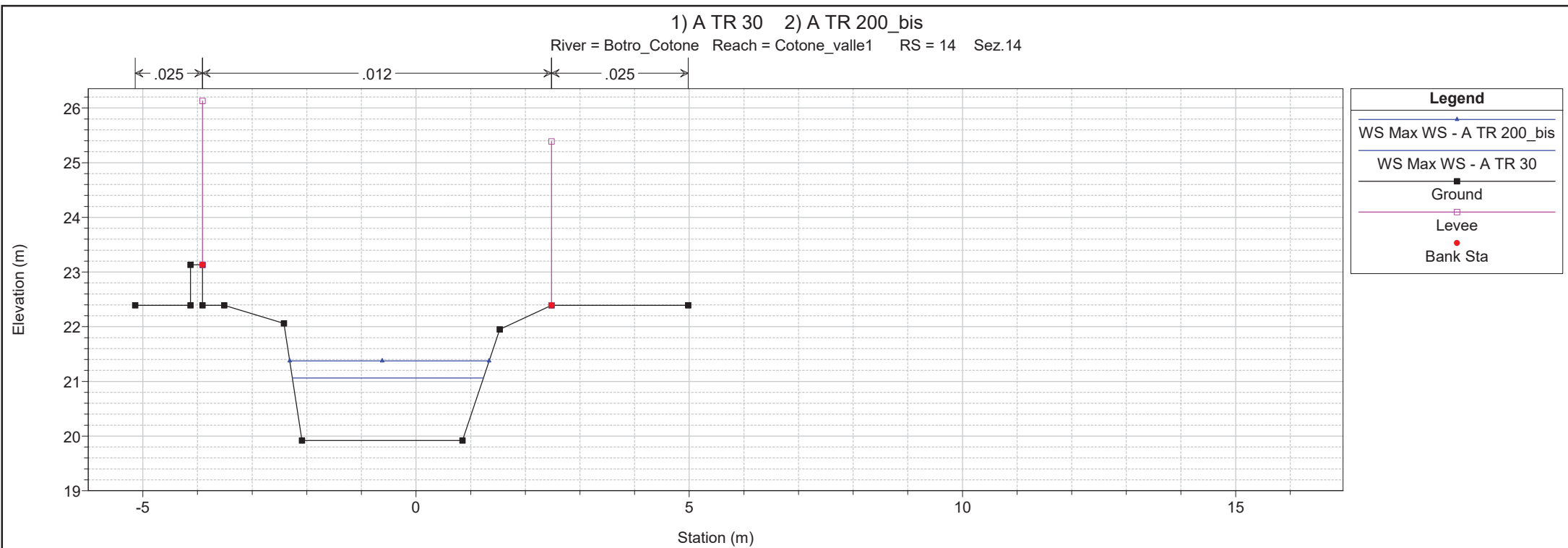

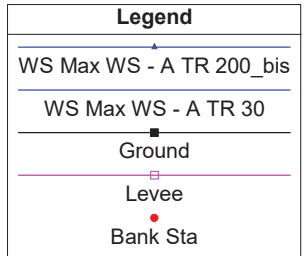
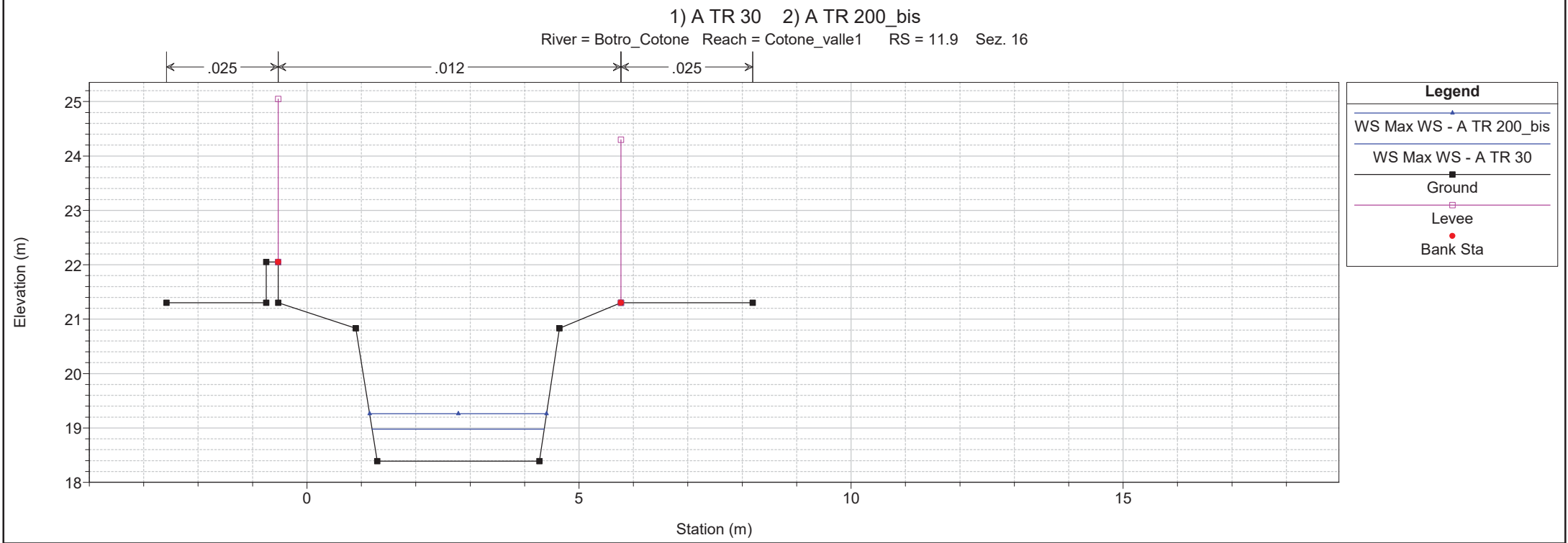
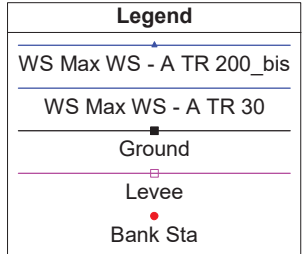
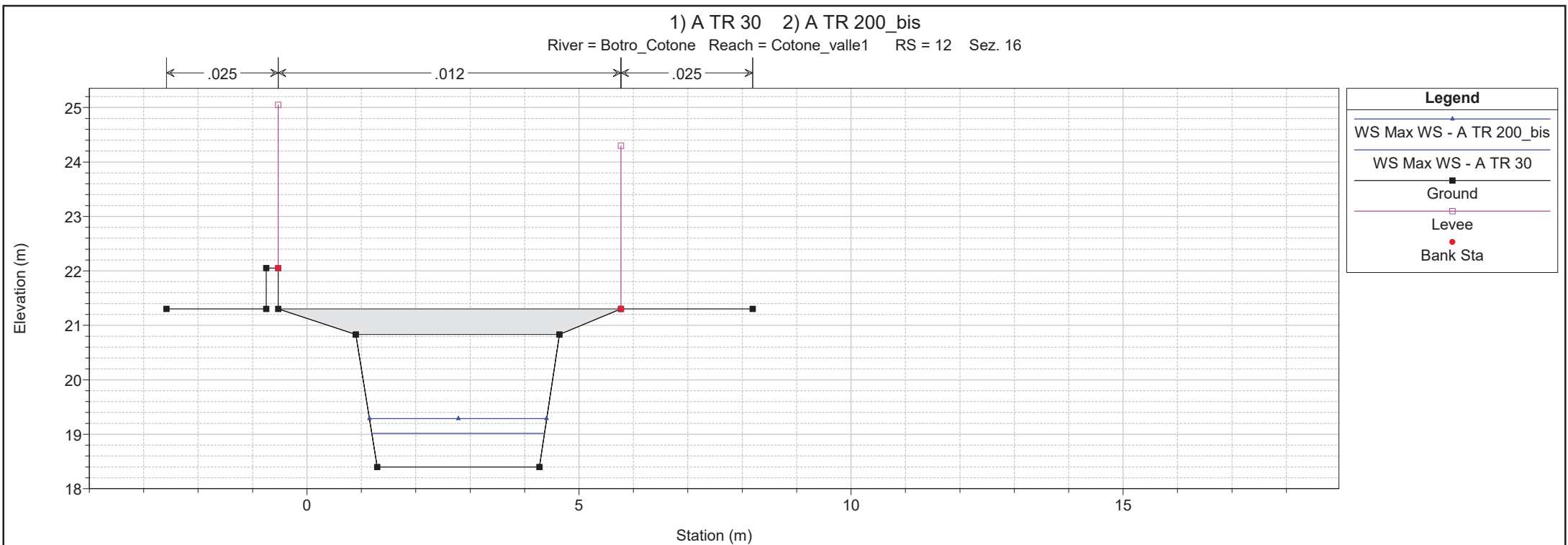

1 cm Horiz. = 1 m 1 cm Vert. = 1 m

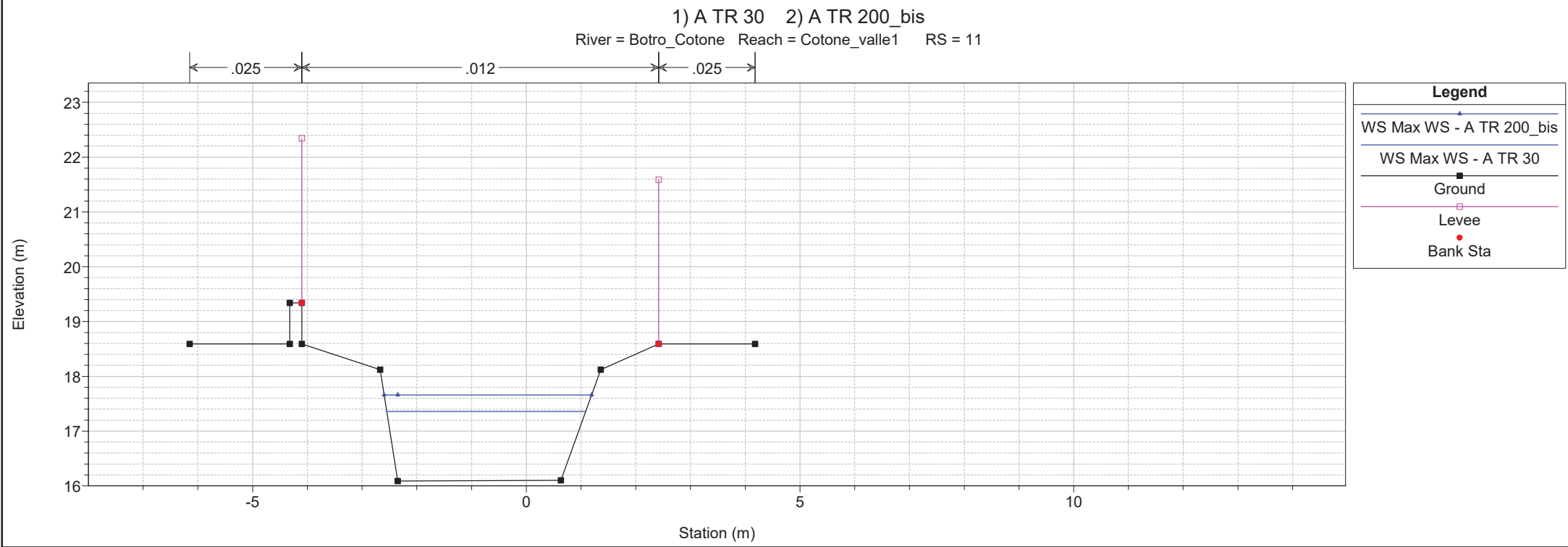
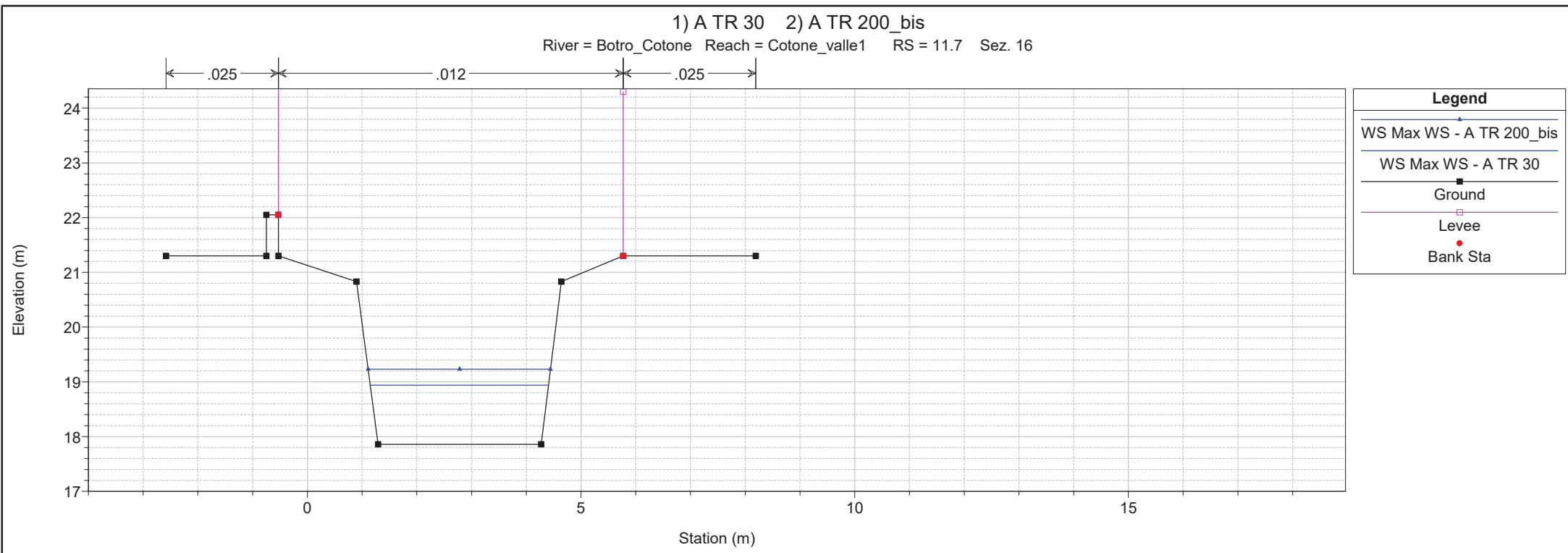

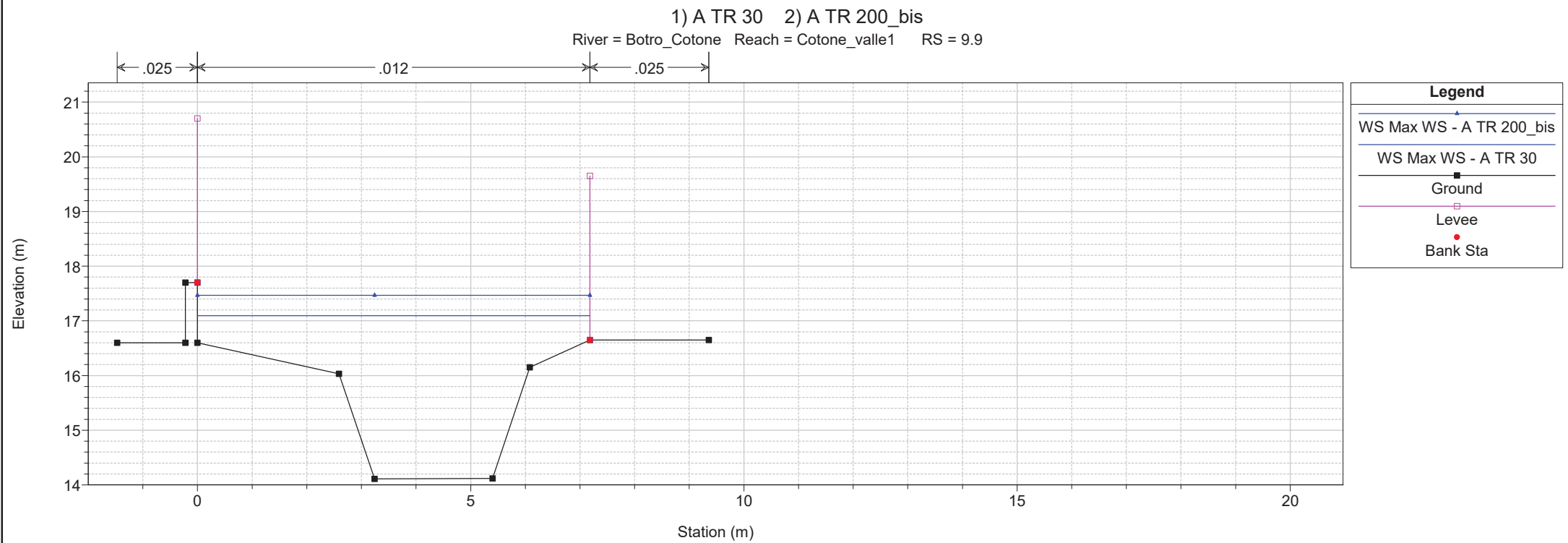
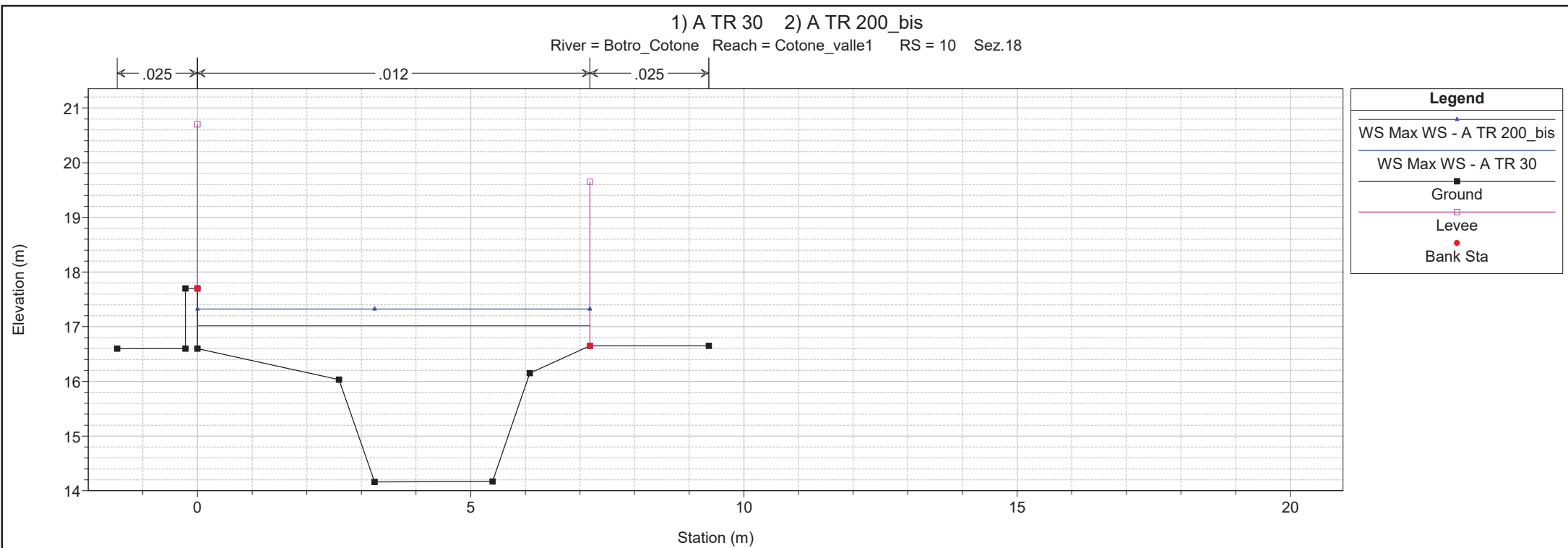

1 cm Horiz. = 1 m 1 cm Vert. = 1 m

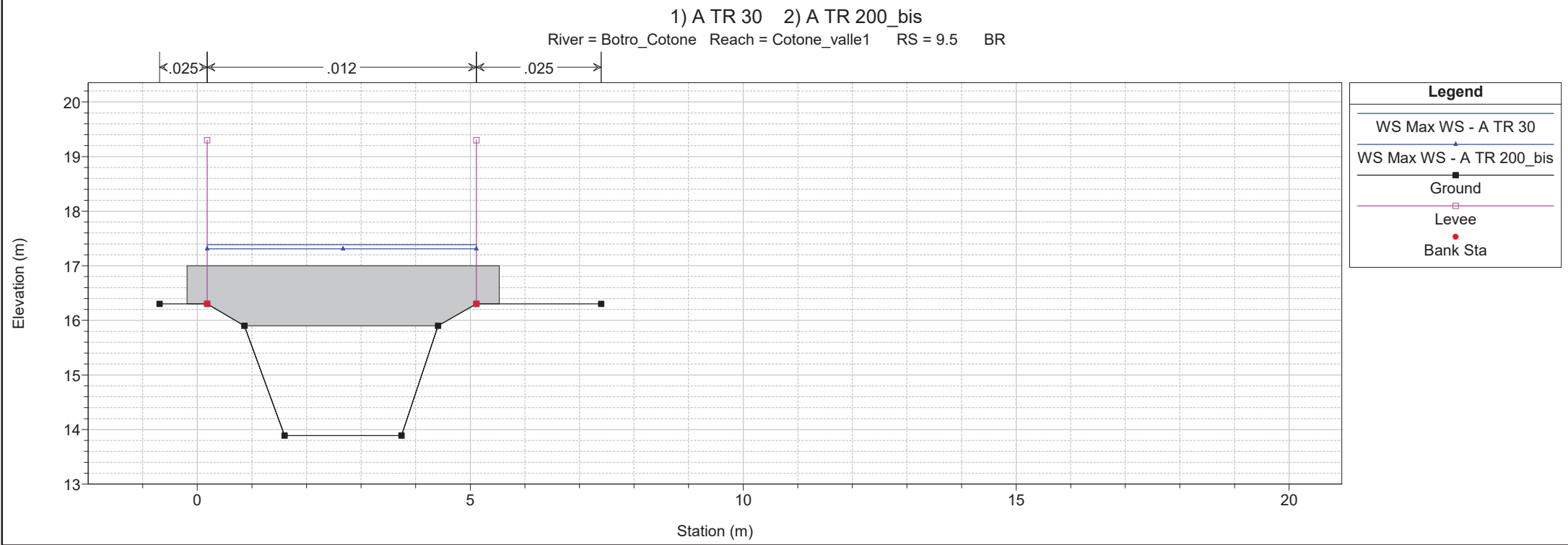
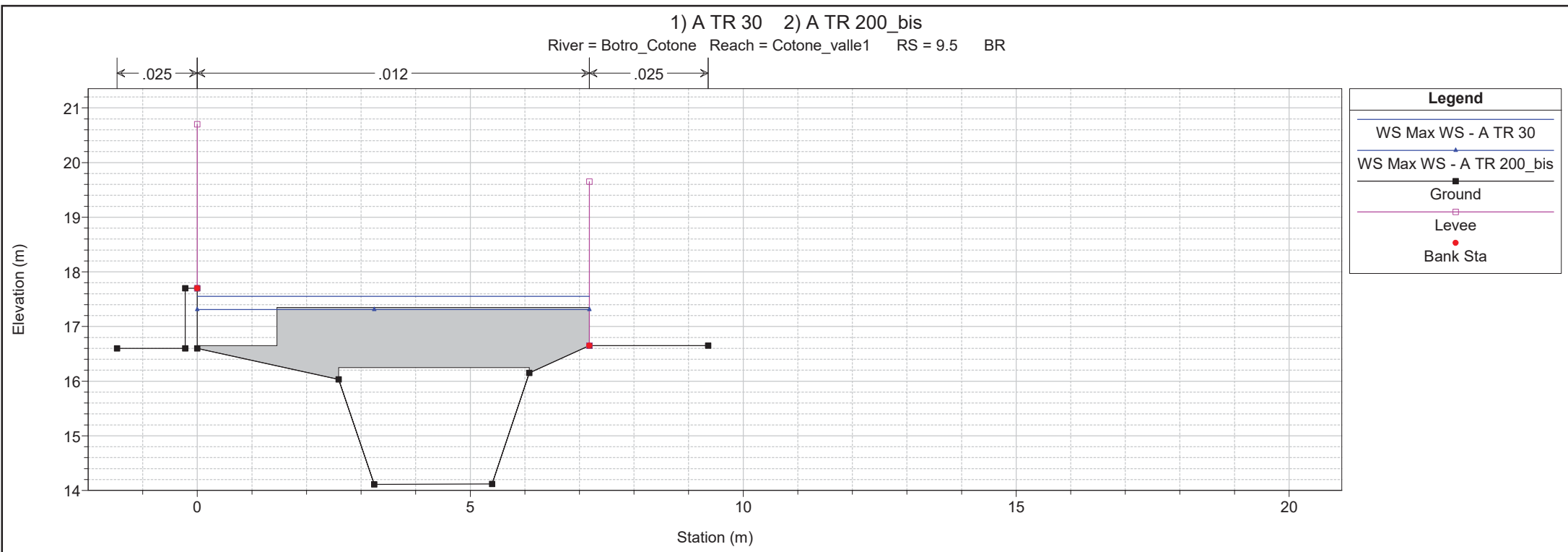

1 cm Horiz. = 1 m 1 cm Vert. = 1 m

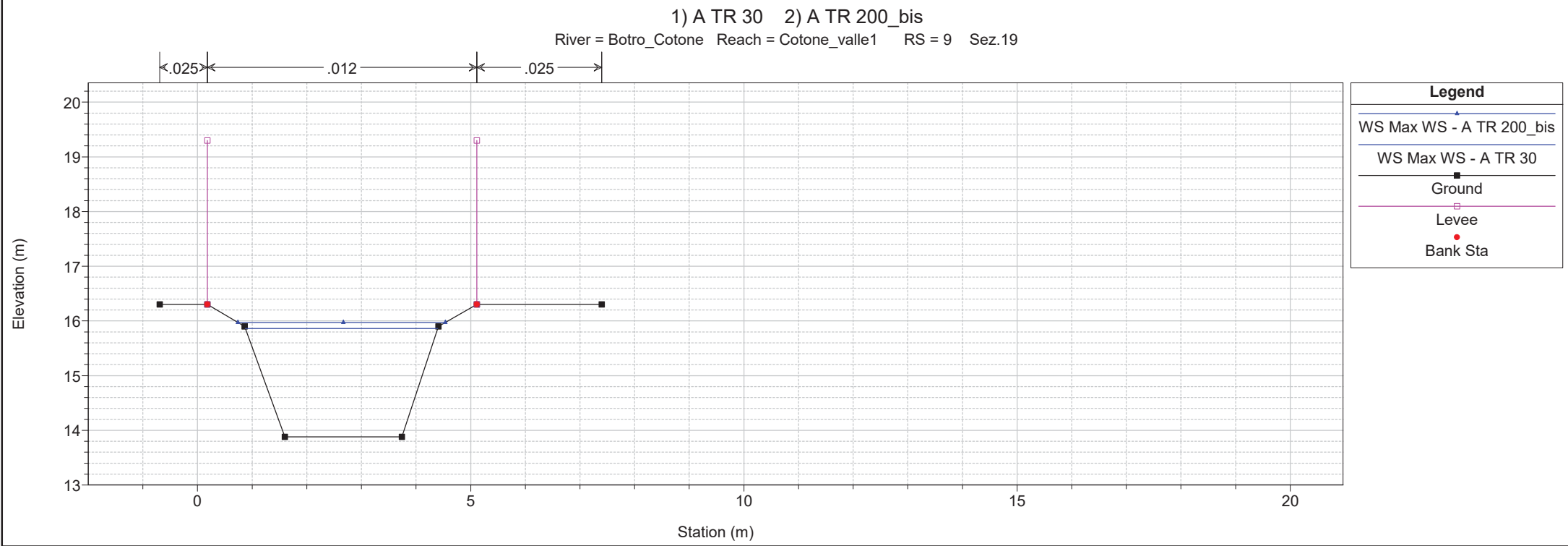
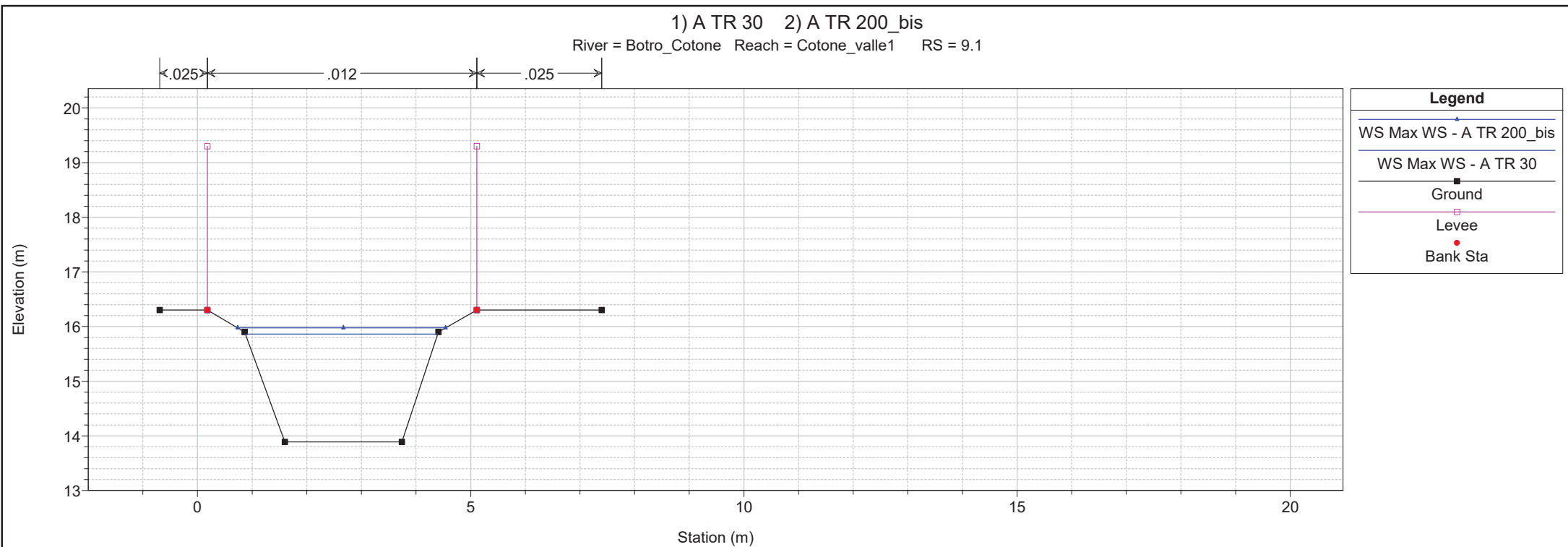

1 cm Horiz. = 1 m 1 cm Vert. = 1 m

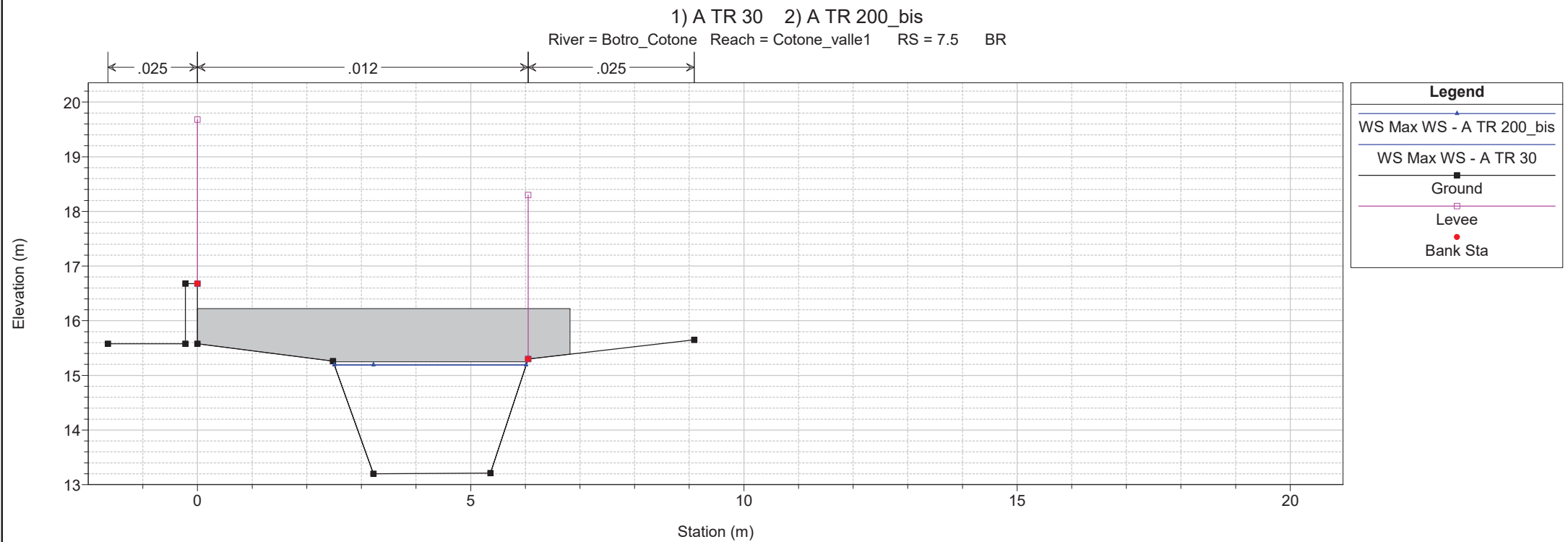
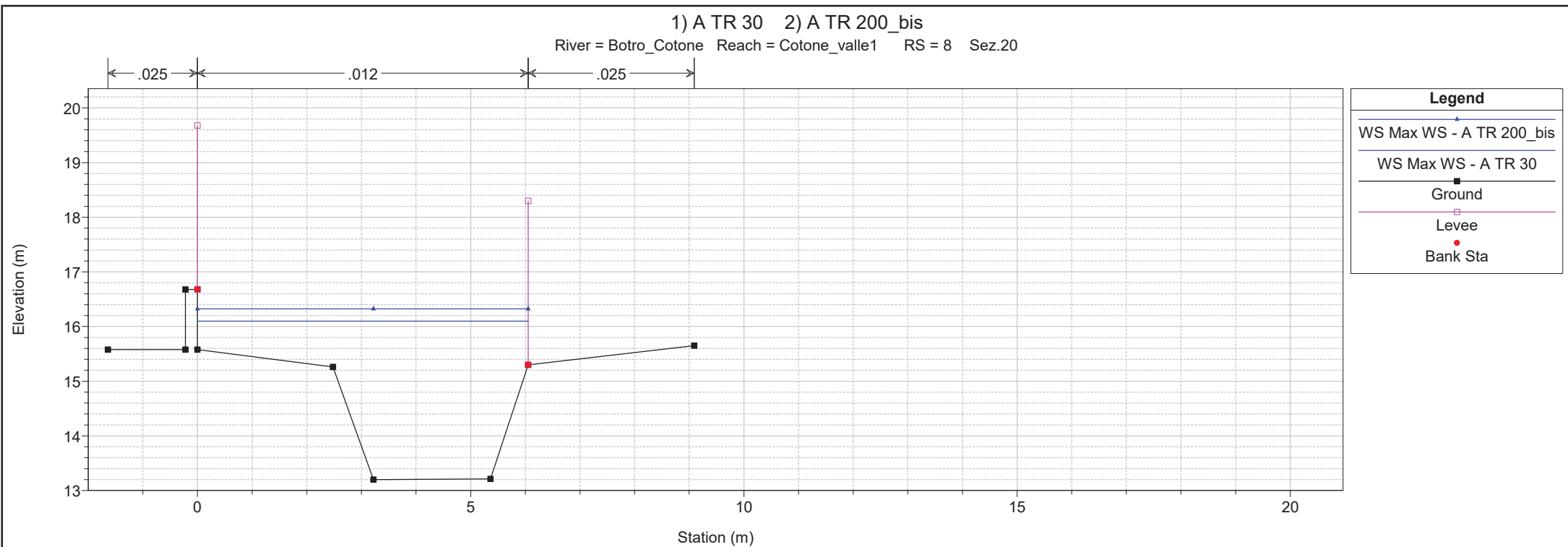

1) A TR 30 2) A TR 200_bis

River = Botro_Cotone Reach = Cotone_valle1 RS = 7.5 BR

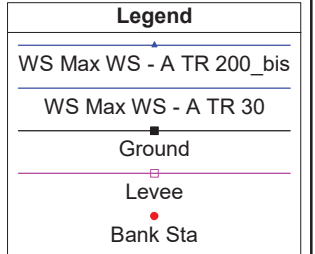
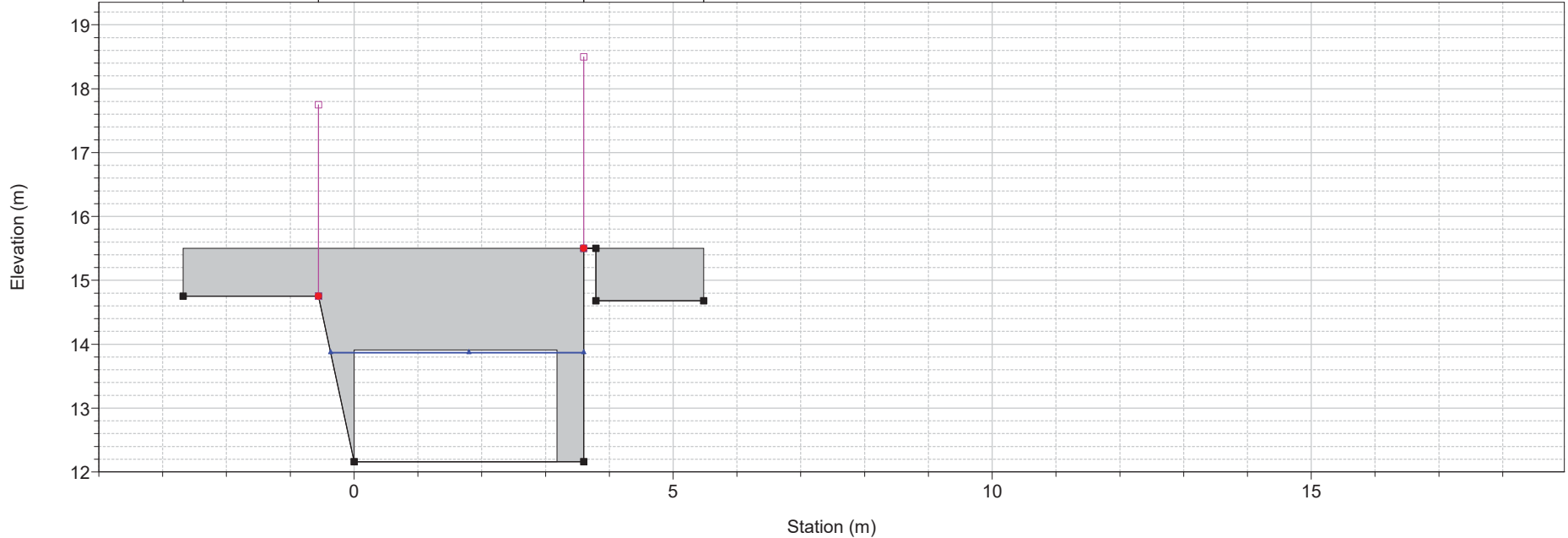
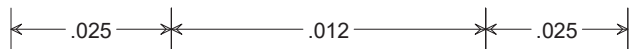

1) A TR 30 2) A TR 200_bis

River = Botro_Cotone Reach = Cotone_valle1 RS = 7 Sez.21

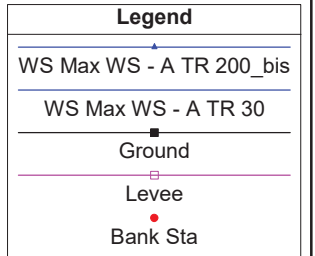
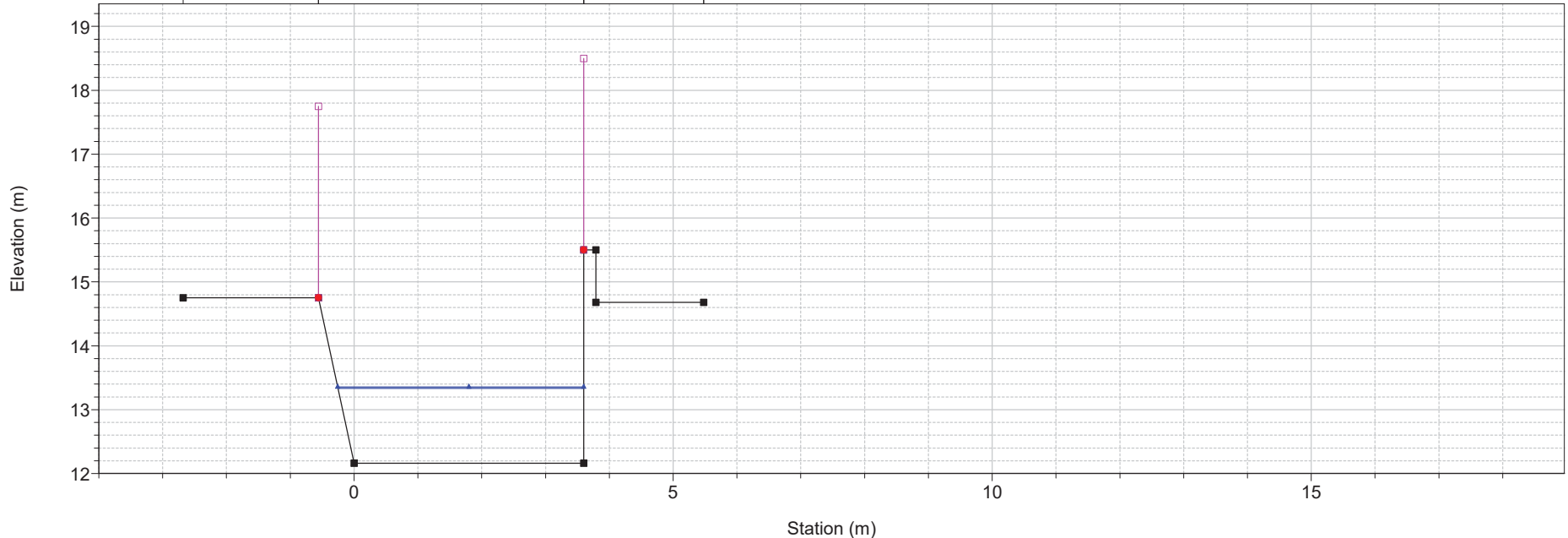

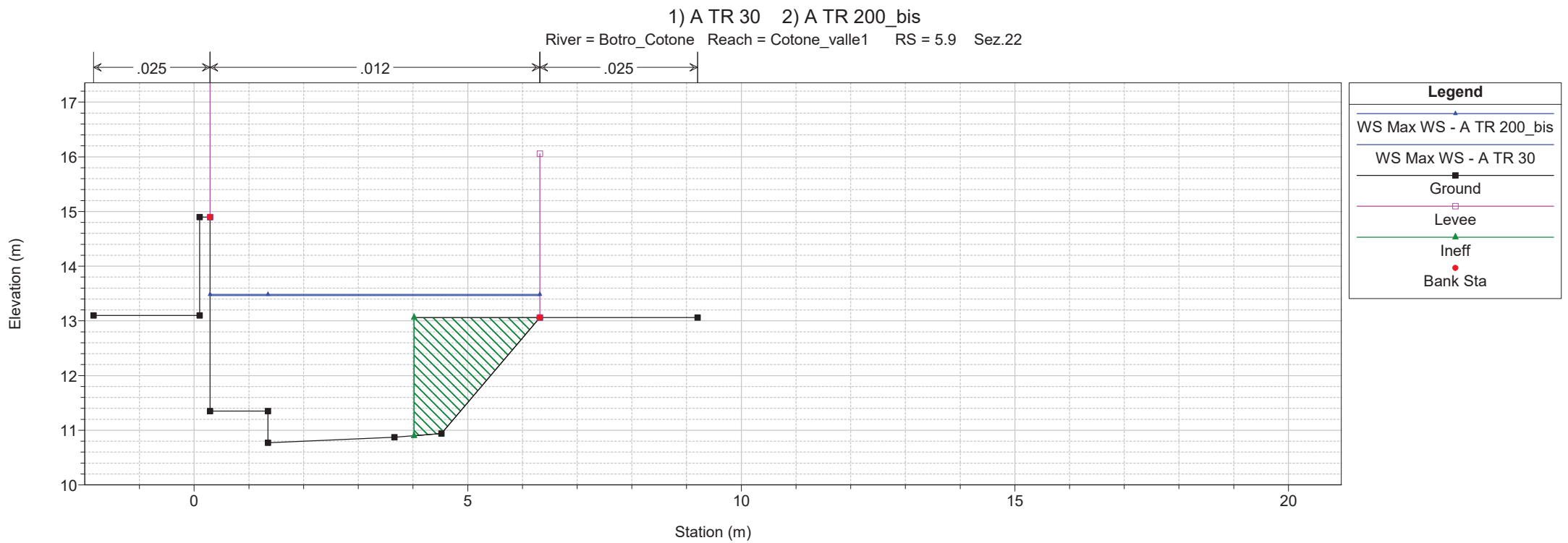
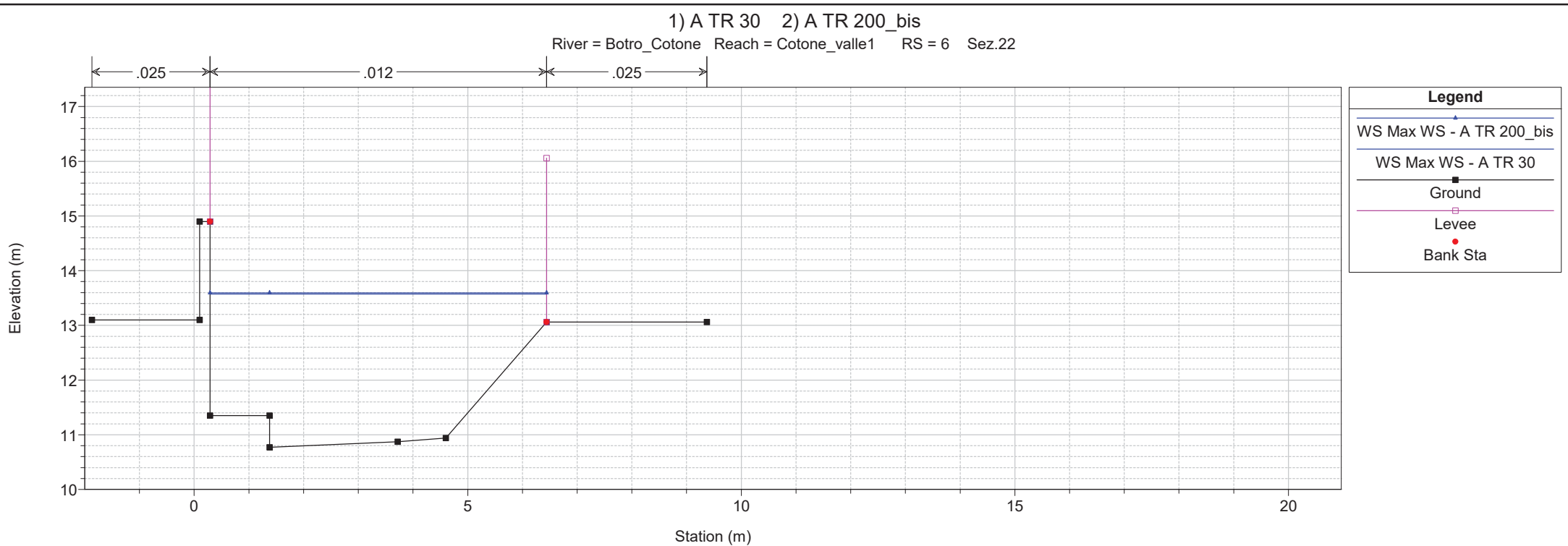

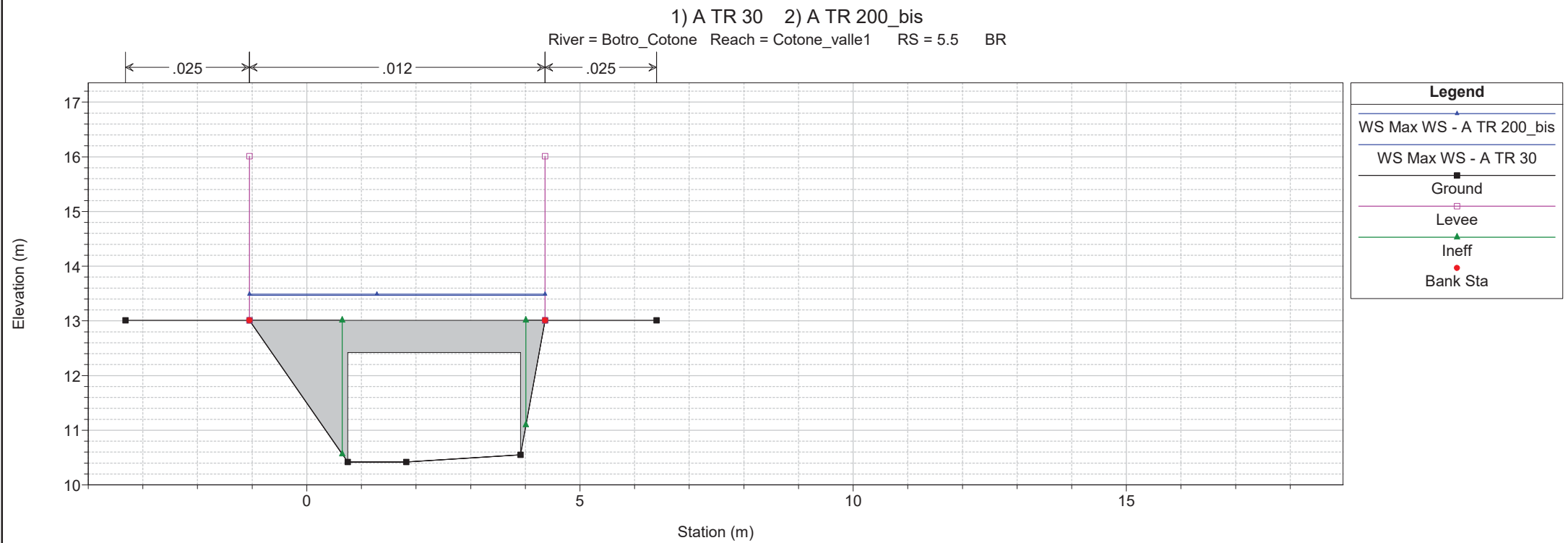
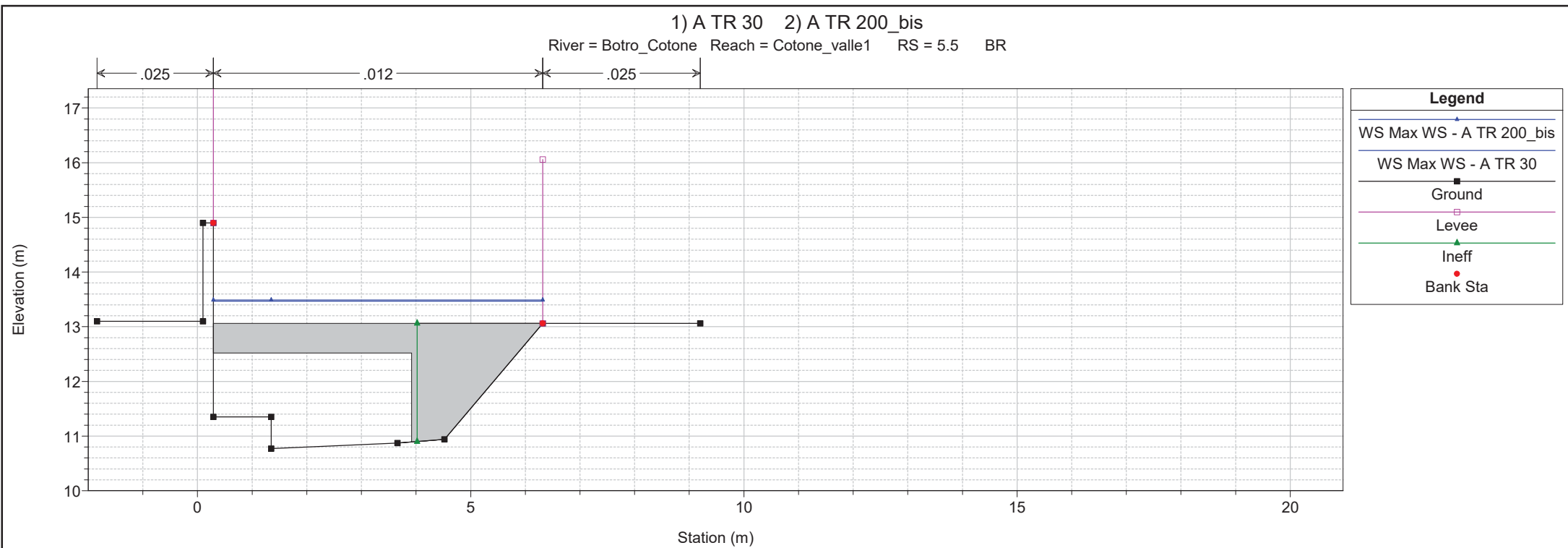

1 cm Horiz. = 1 m 1 cm Vert. = 1 m

1) A TR 30 2) A TR 200_bis

River = Botro_Cotone Reach = Cotone_valle1 RS = 5.1 Sez. 23

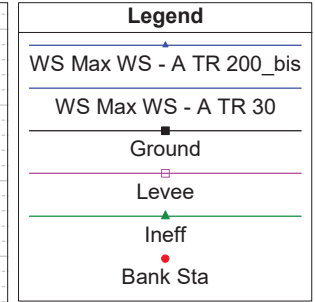
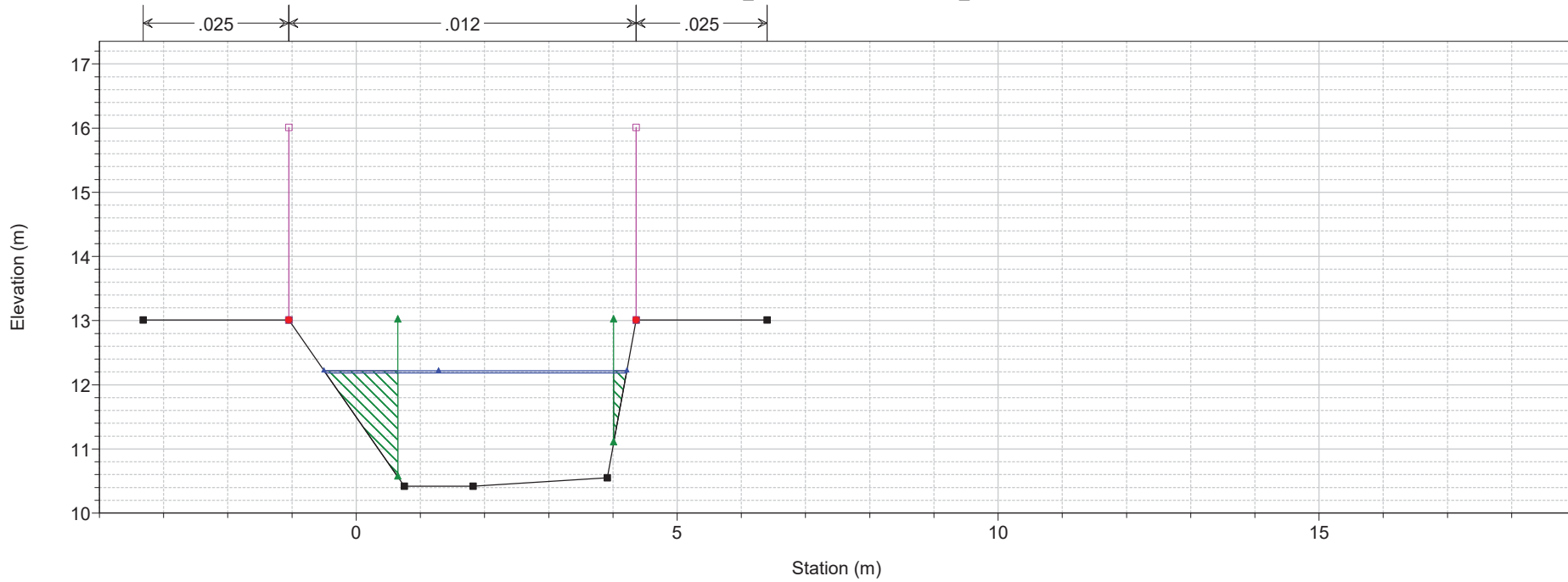

1) A TR 30 2) A TR 200_bis

River = Botro_Cotone Reach = Cotone_valle1 RS = 5 Sez. 23

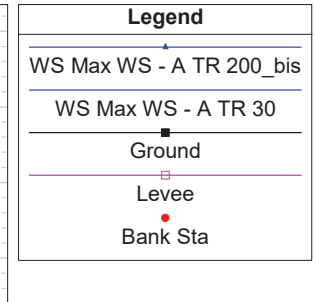
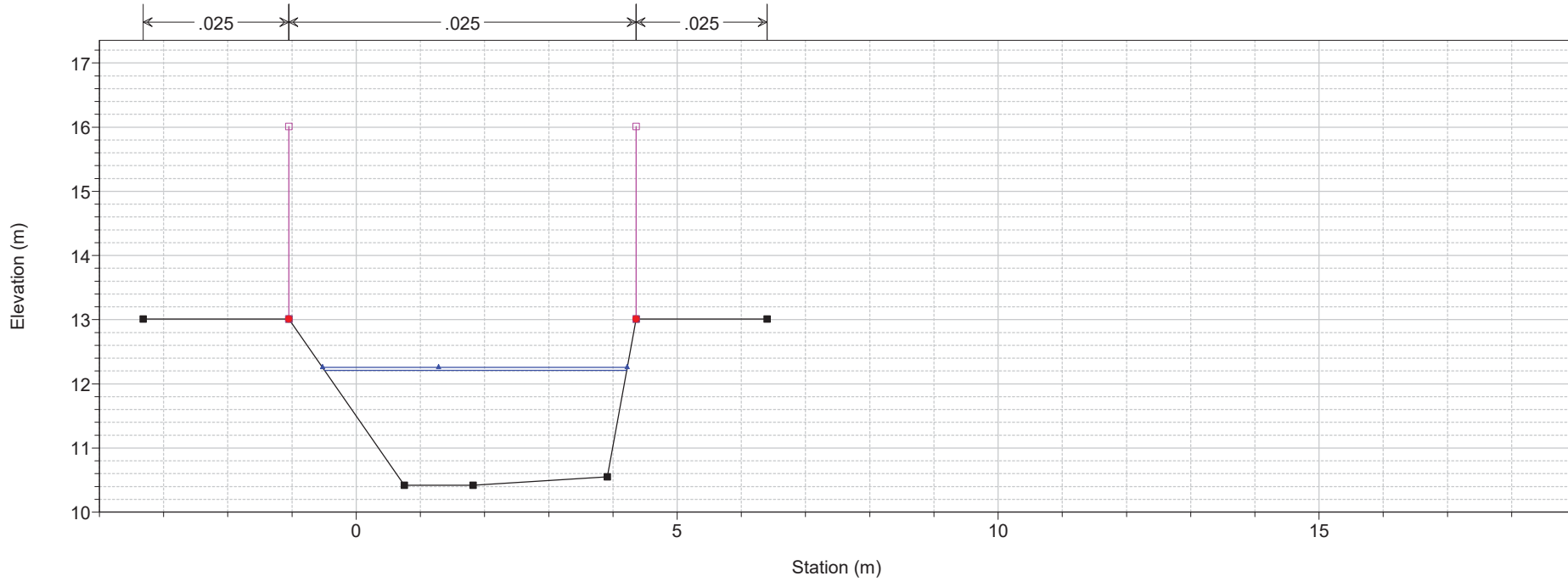

1) A TR 30 2) A TR 200_bis
 River = Botro_Cotone Reach = Cotone_valle1 RS = 4

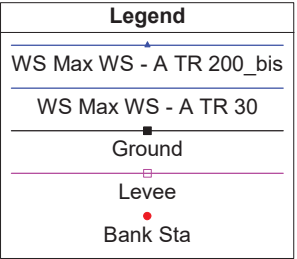
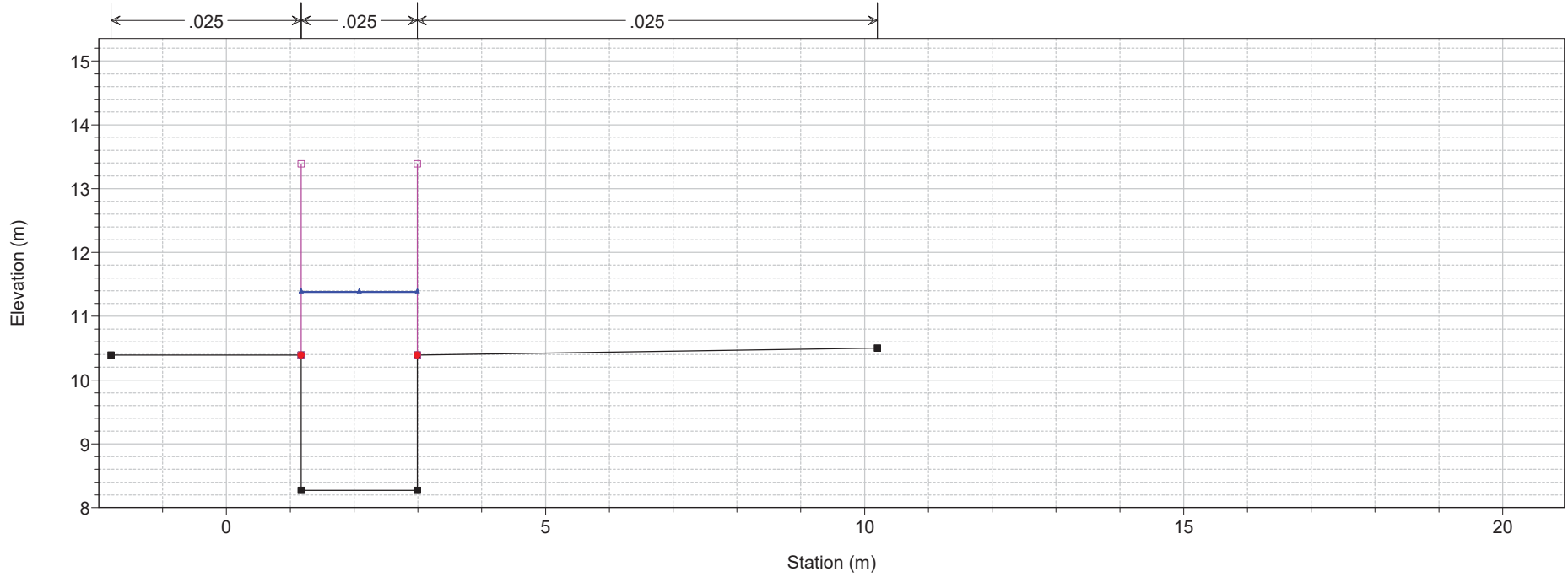

1) A TR 30 2) A TR 200_bis
 River = Botro_Cotone Reach = Cotone_valle1 RS = 3.5 BR

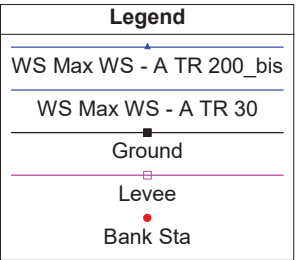
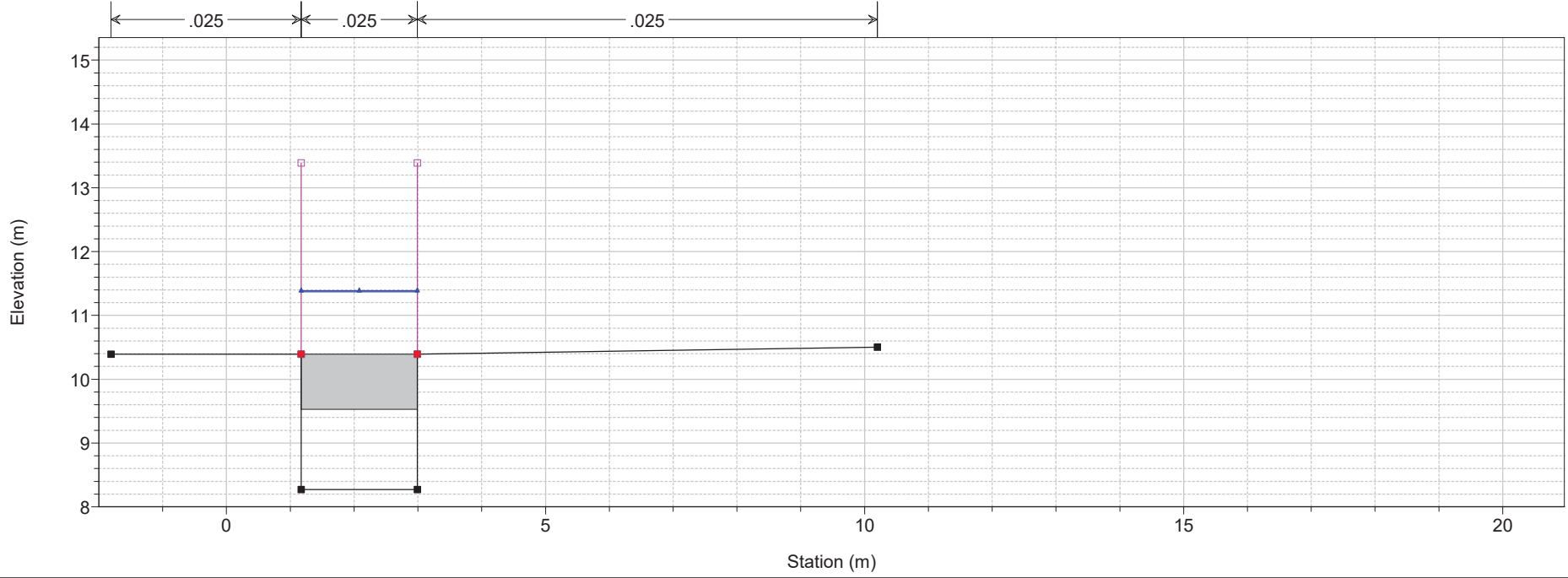

1 cm Horiz. = 1 m 1 cm Vert. = 1 m

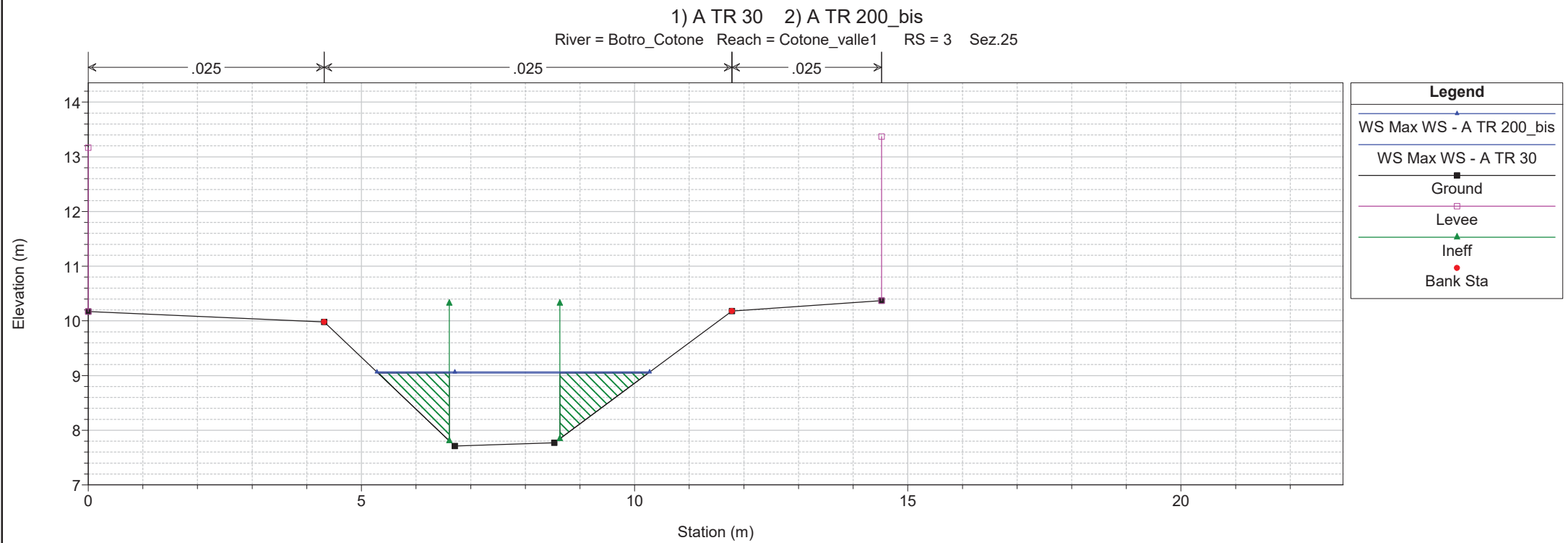
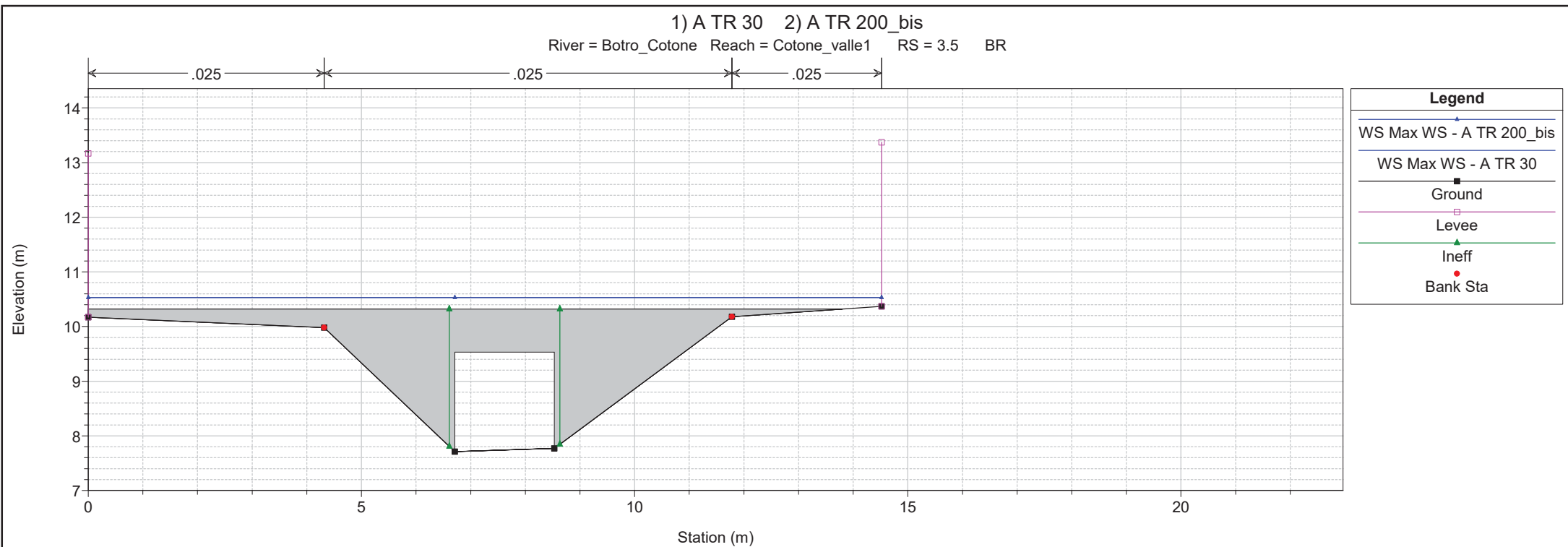

1) A TR 30 2) A TR 200_bis
 River = Botro_Cotone Reach = Cotone_valle1 RS = 2.1 Sez.26

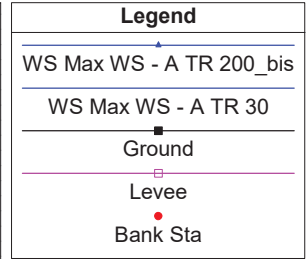
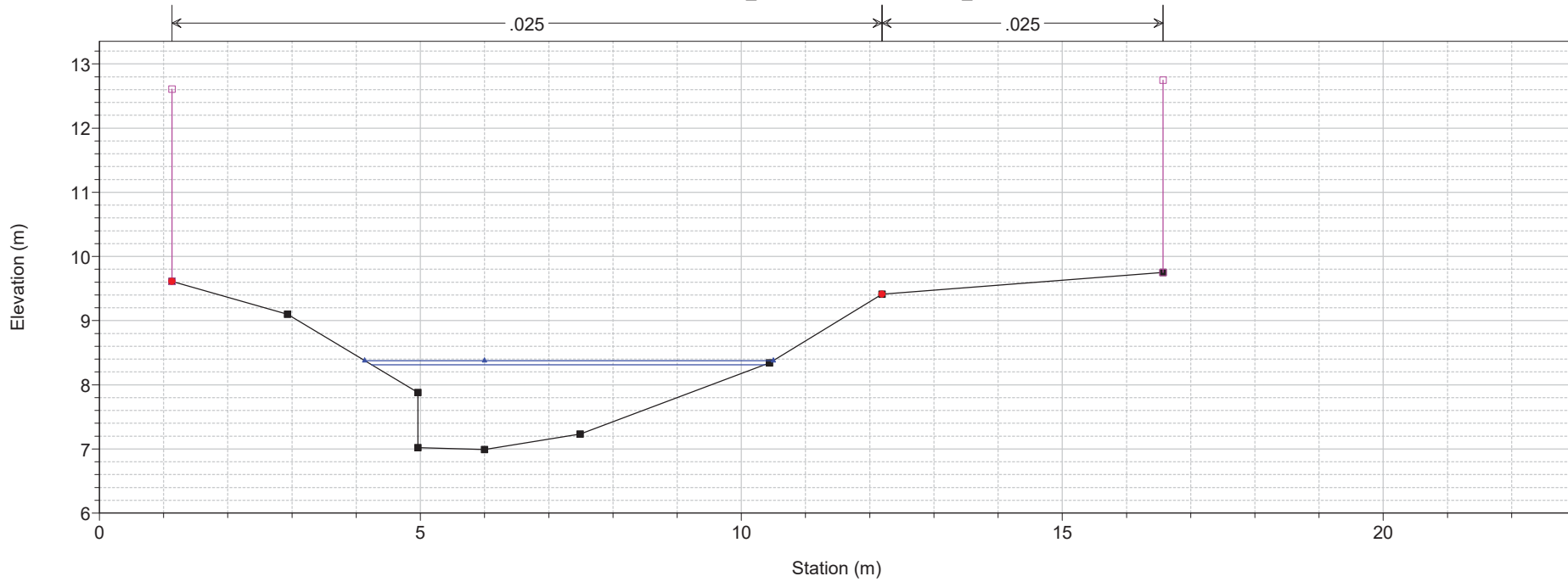

1) A TR 30 2) A TR 200_bis
 River = Botro_Cotone Reach = Cotone_valle1 RS = 2 Sez.26

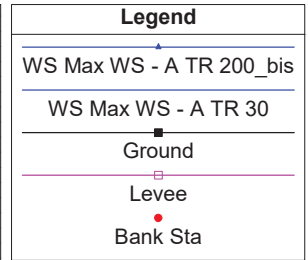
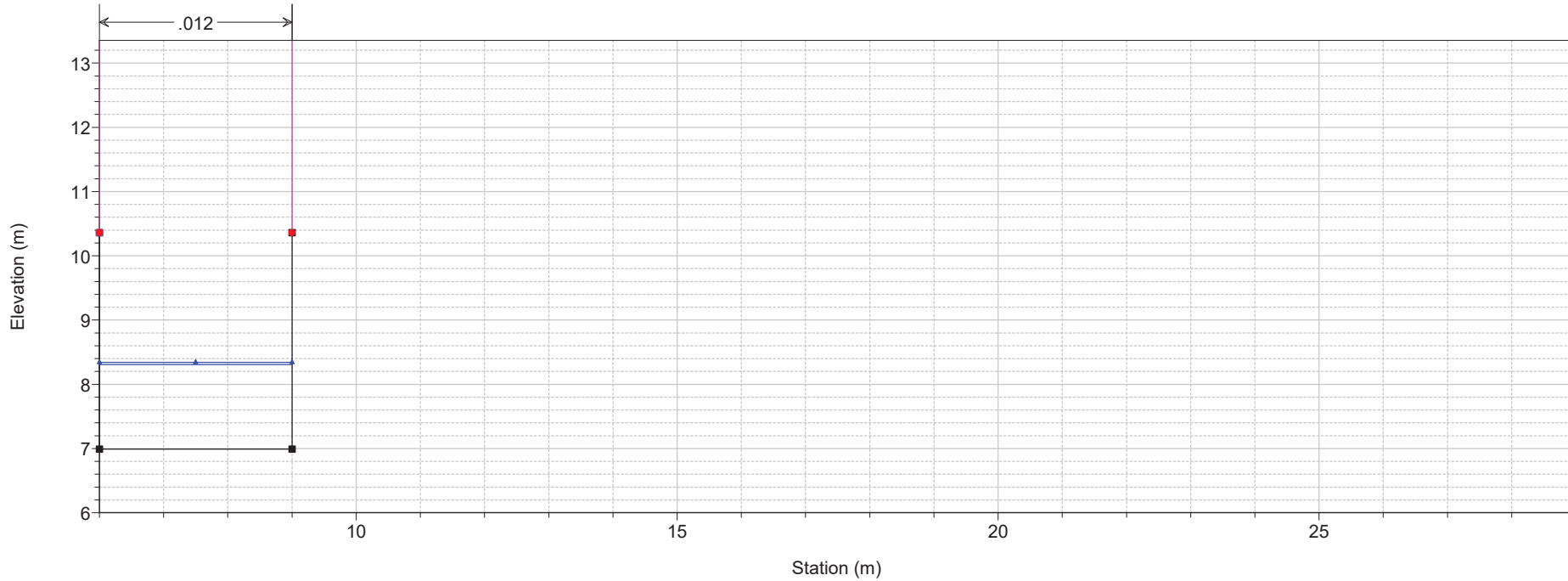

1) A TR 30 2) A TR 200_bis
 River = Botro_Cotone Reach = Cotone_valle1 RS = 1.9 BR

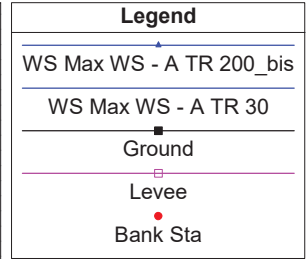
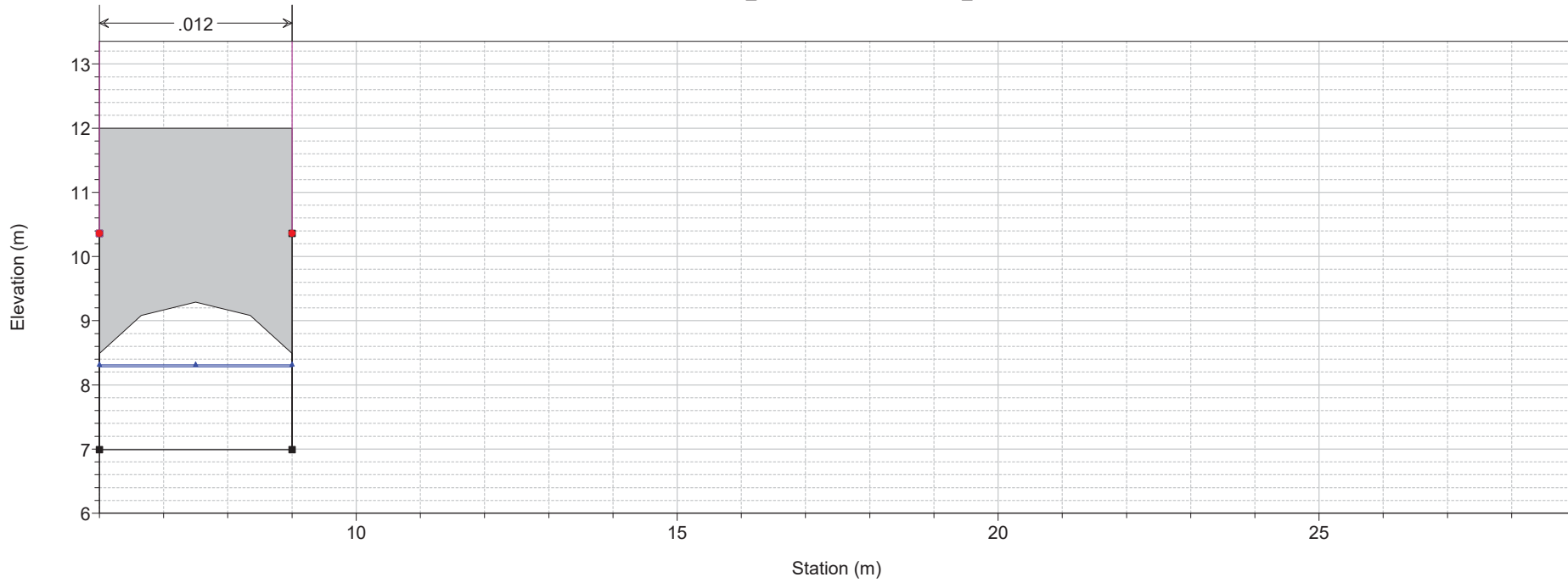

1) A TR 30 2) A TR 200_bis
 River = Botro_Cotone Reach = Cotone_valle1 RS = 1.9 BR

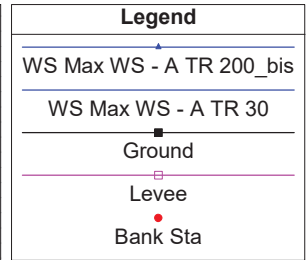
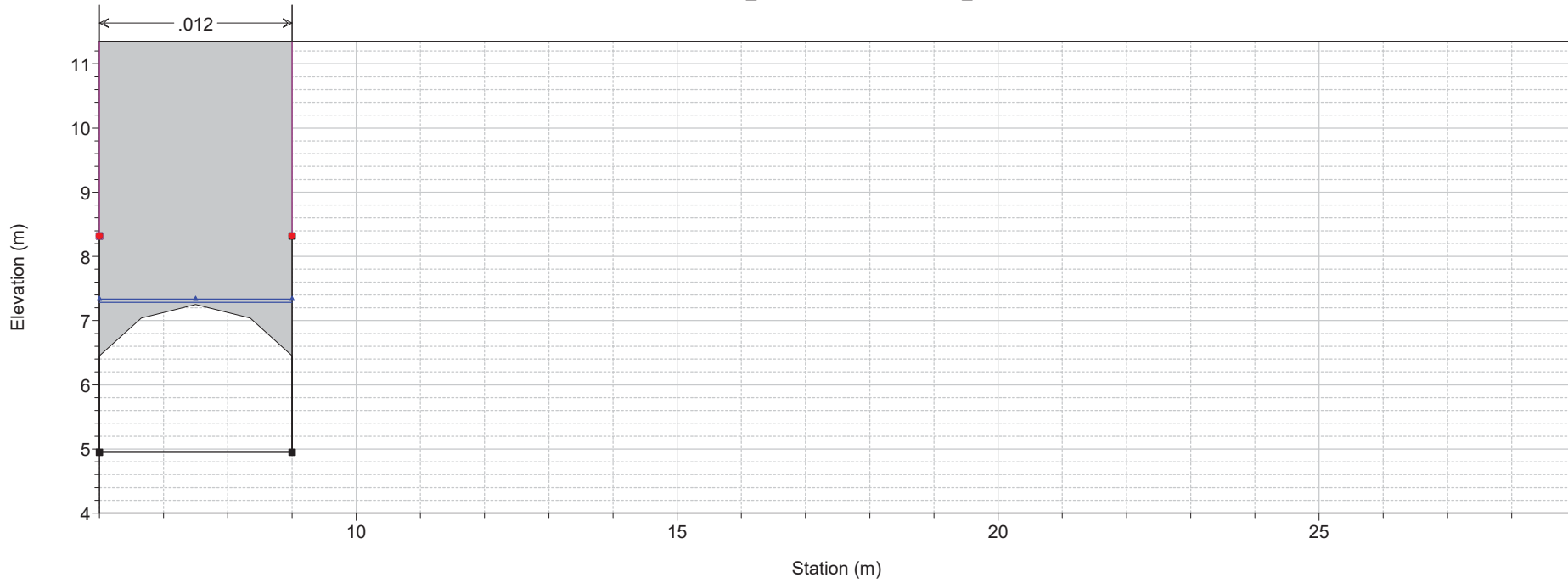

1) A TR 30 2) A TR 200_bis
River = Botro_Cotone Reach = Cotone_valle1 RS = 1.81

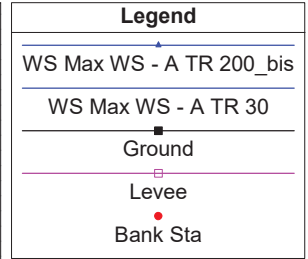
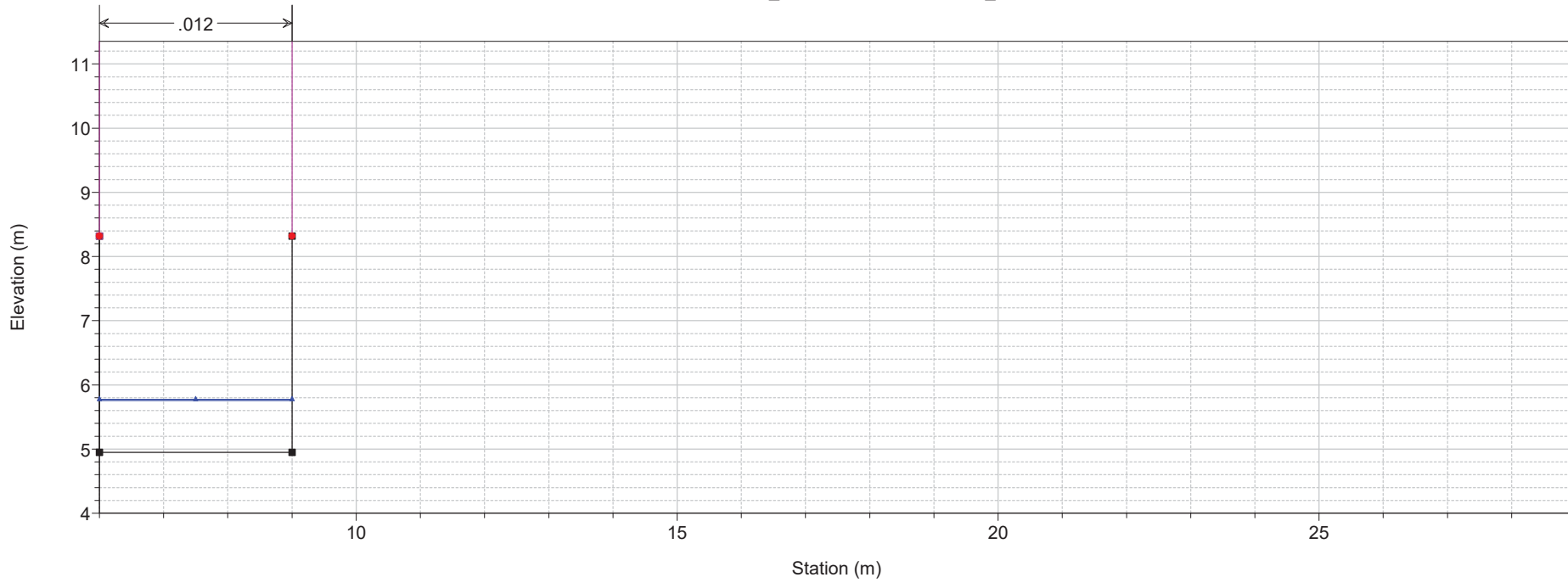

1) A TR 30 2) A TR 200_bis
River = Botro_Cotone Reach = Cotone_valle1 RS = 1.8

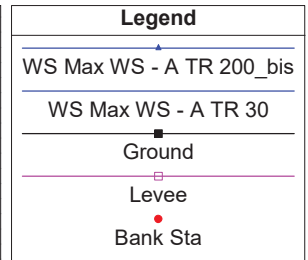
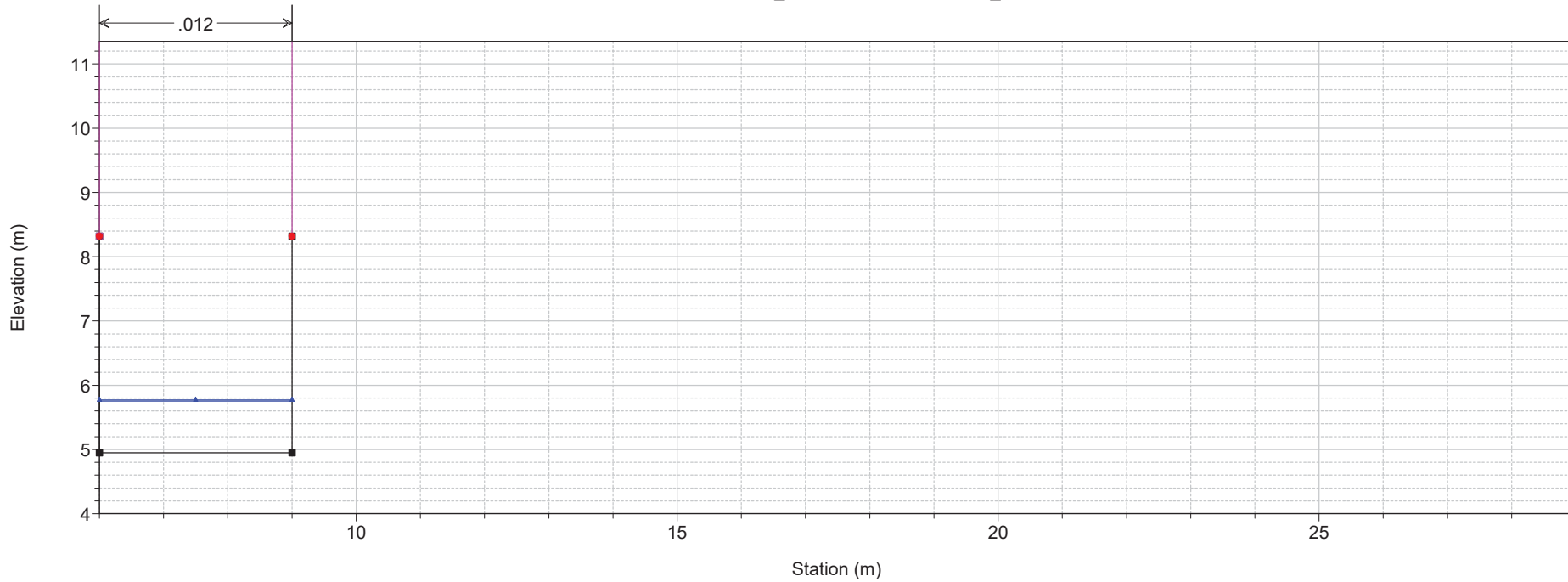

1) A TR 30 2) A TR 200_bis
 River = Botro_Cotone Reach = Cotone_valle2 RS = 1.71

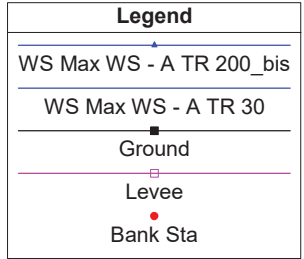
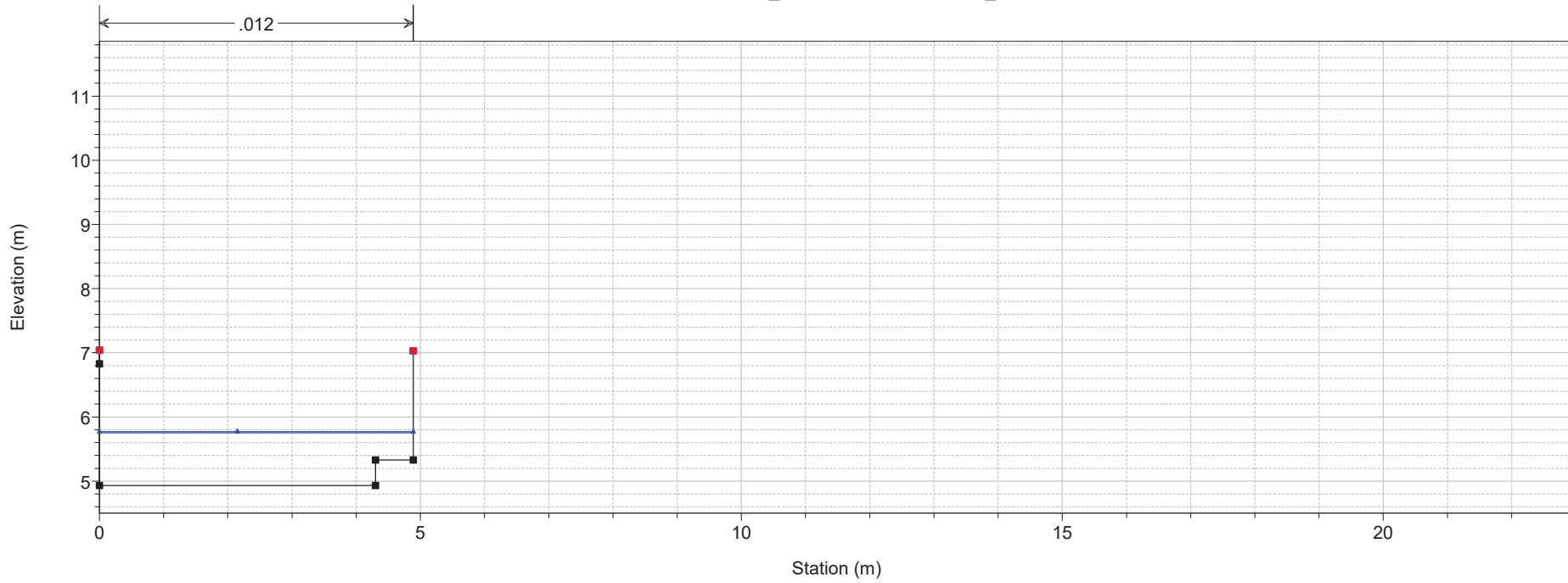

1) A TR 30 2) A TR 200_bis
 River = Botro_Cotone Reach = Cotone_valle2 RS = 1.7

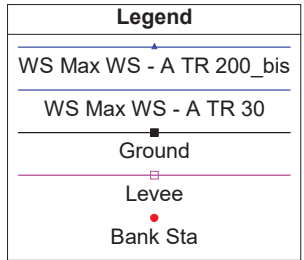
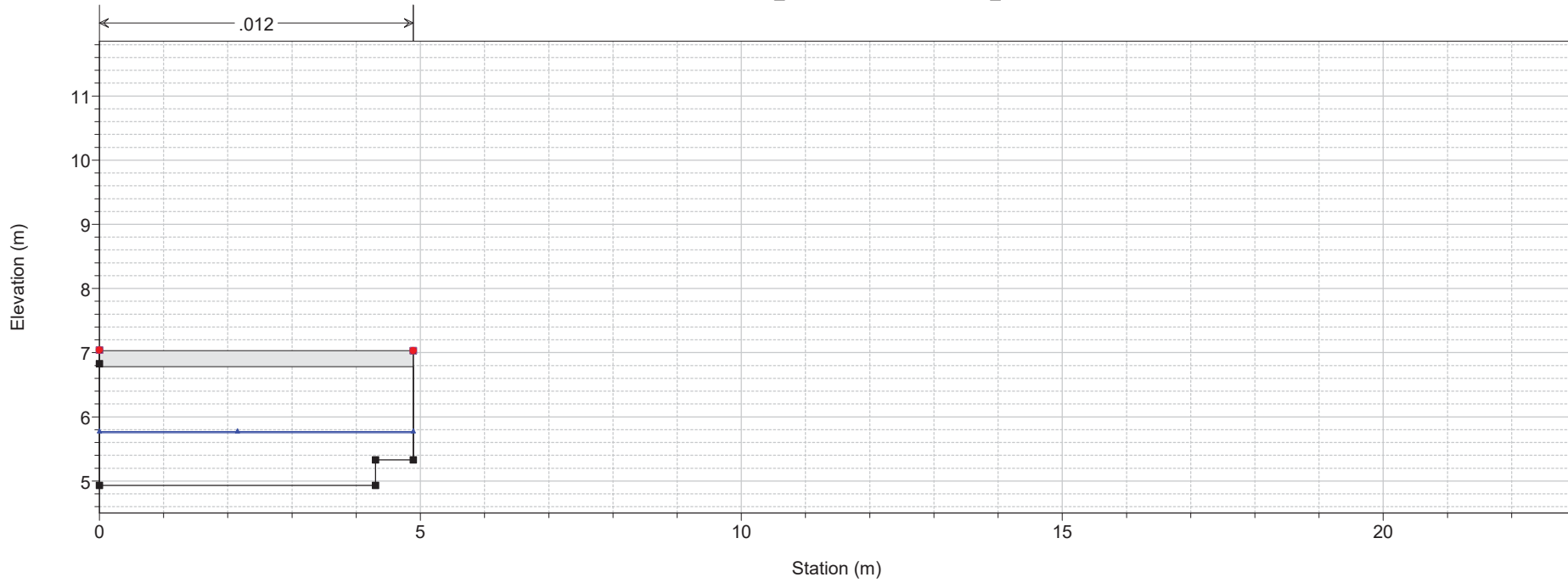

1) A TR 30 2) A TR 200_bis
 River = Botro_Cotone Reach = Cotone_valle2 RS = 1.5 Sez. 27bis

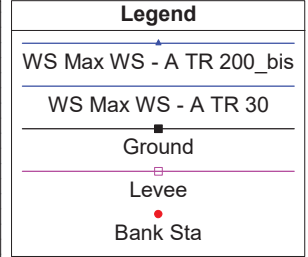
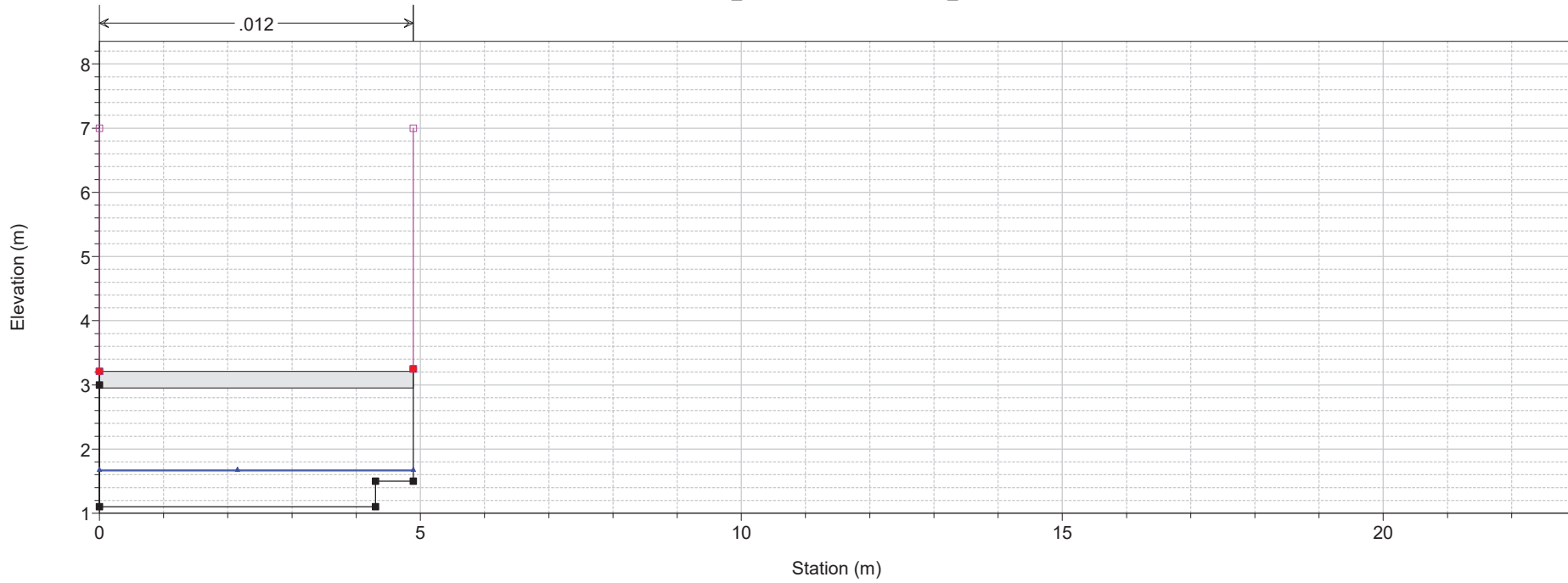

1) A TR 30 2) A TR 200_bis
 River = Botro_Cotone Reach = Cotone_valle2 RS = 1.4 Sez. 27

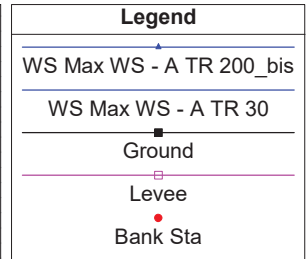
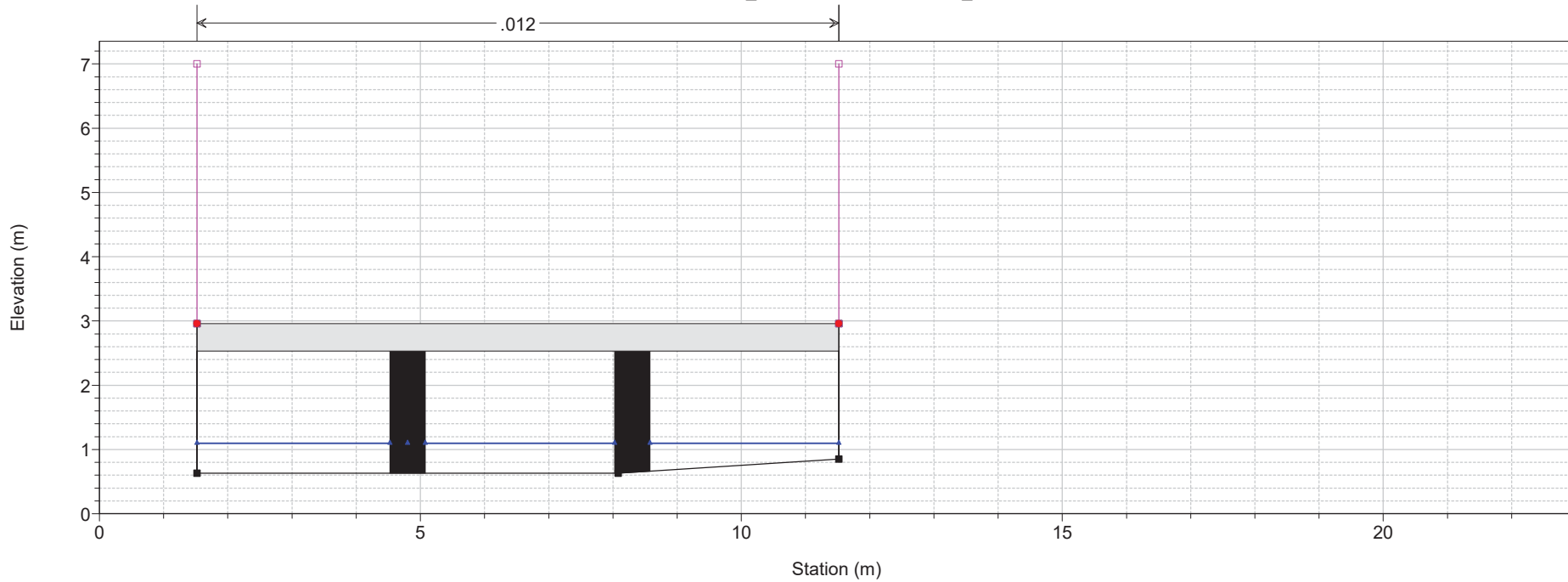

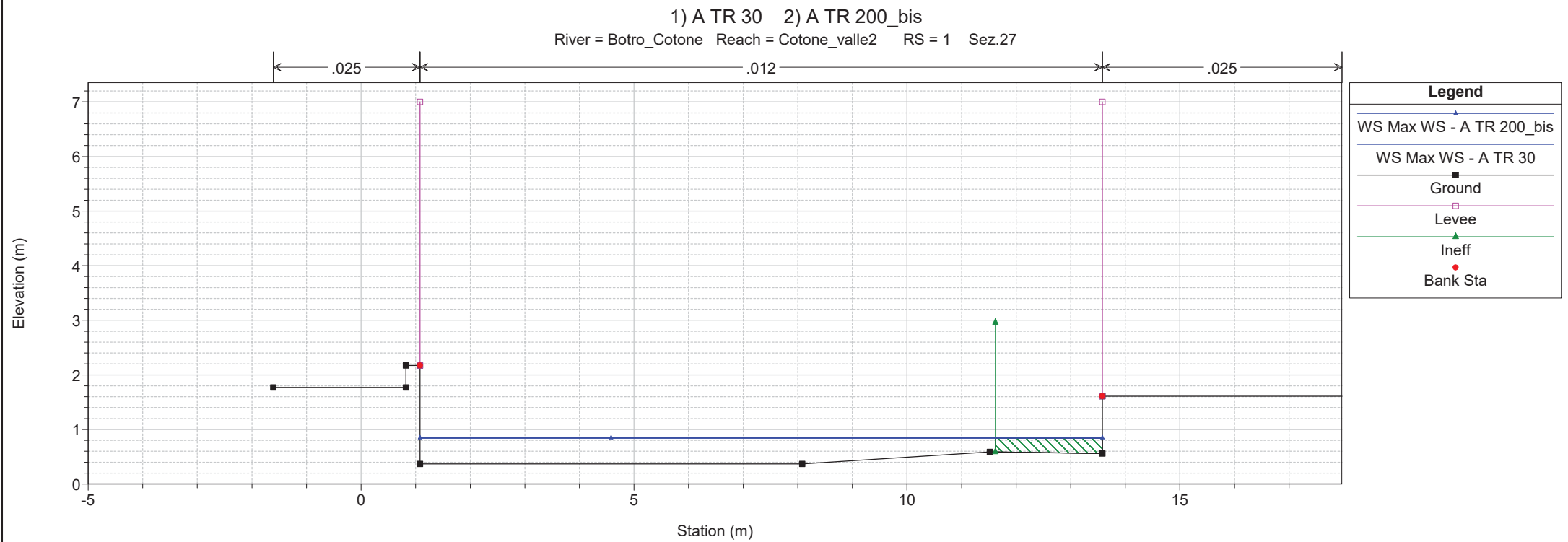
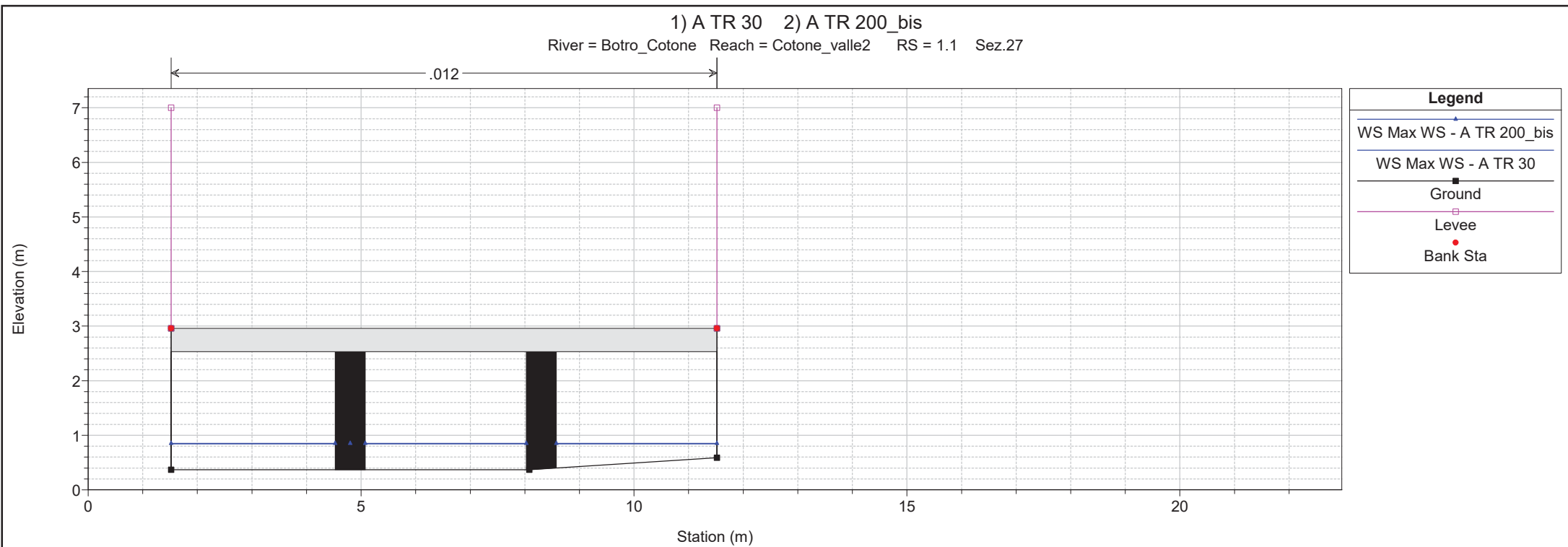

1 cm Horiz. = 1 m 1 cm Vert. = 1 m

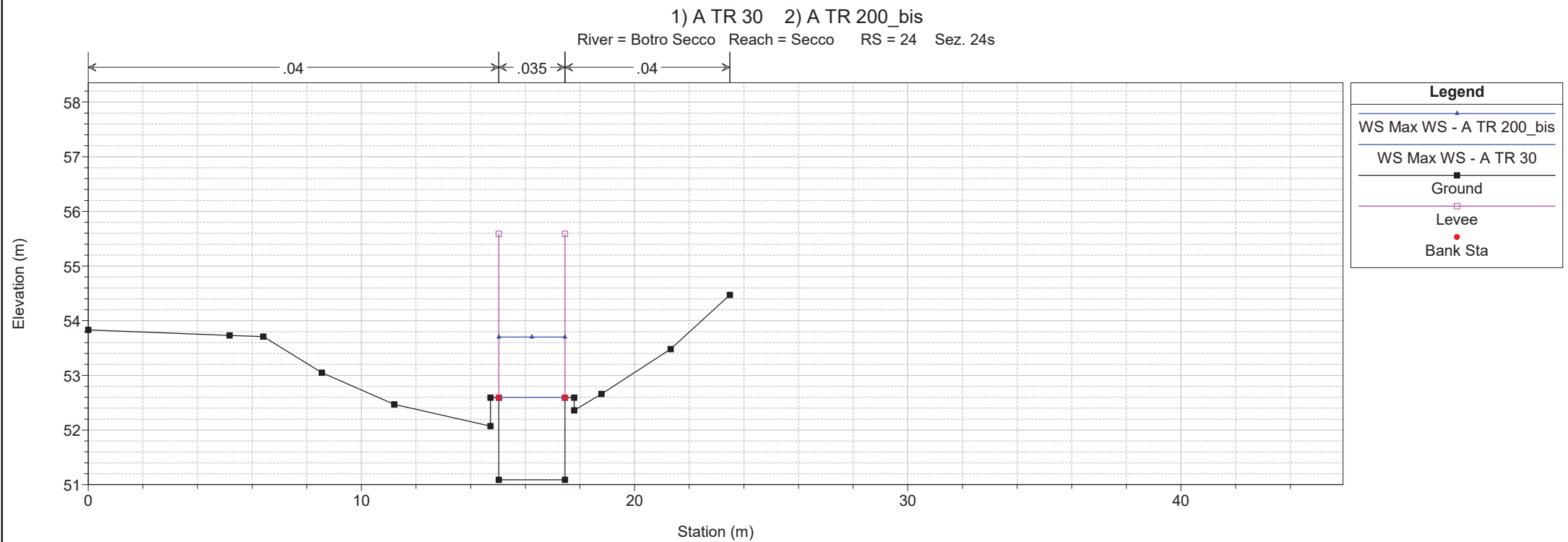
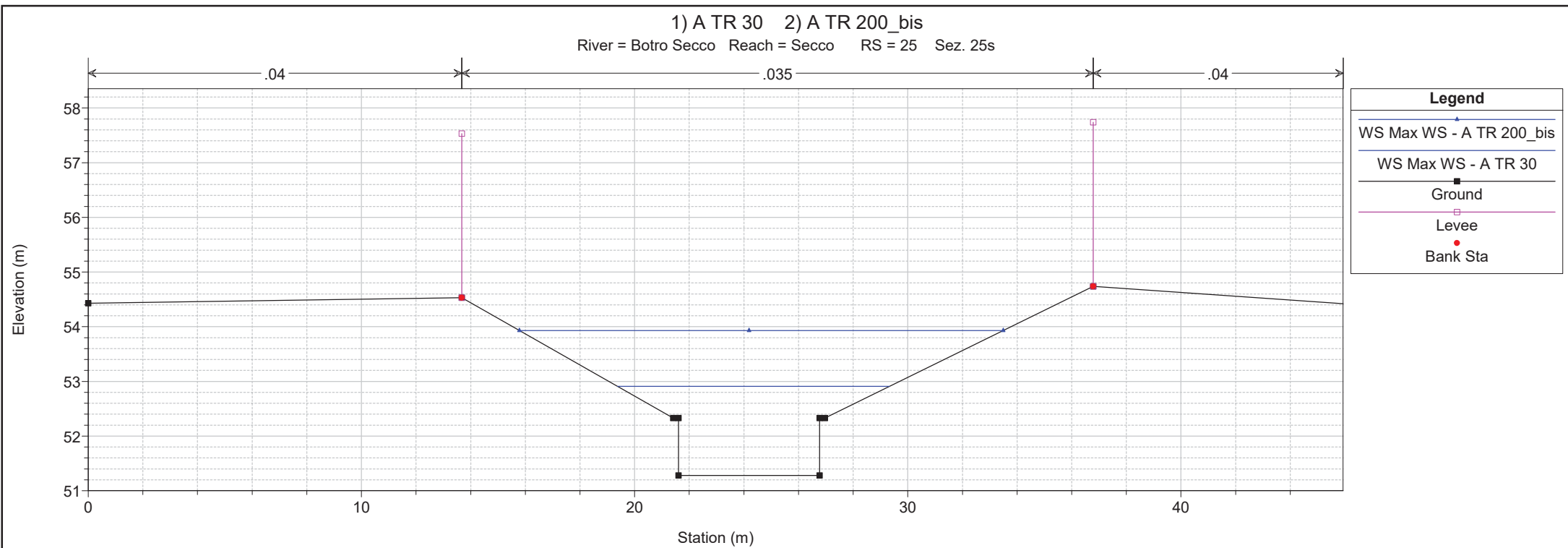

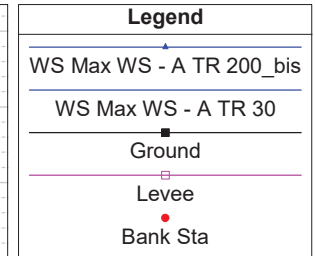
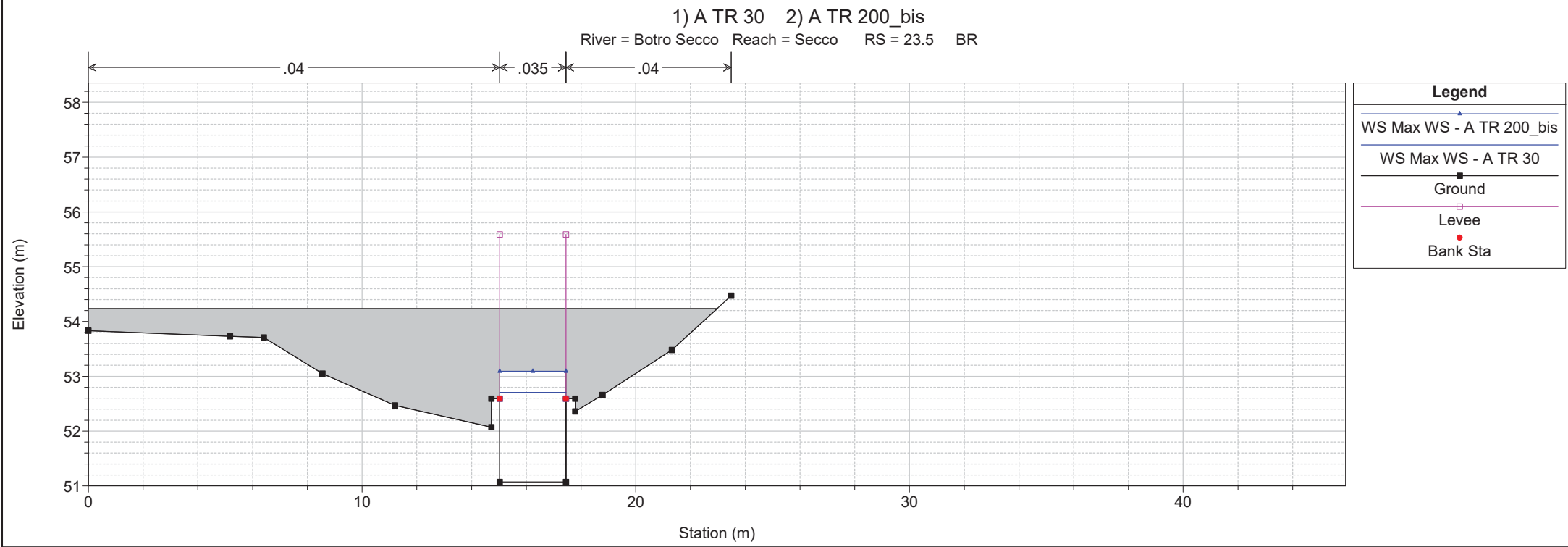
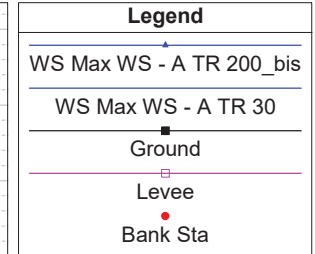
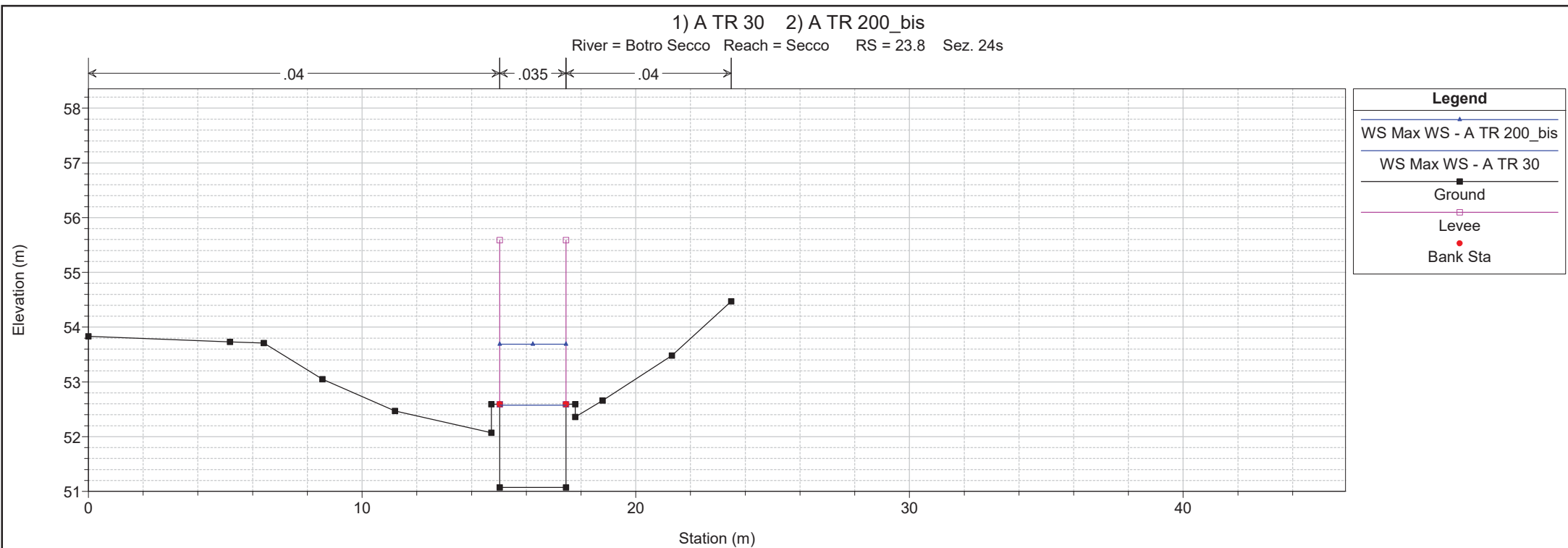

1 cm Horiz. = 2 m 1 cm Vert. = 1 m

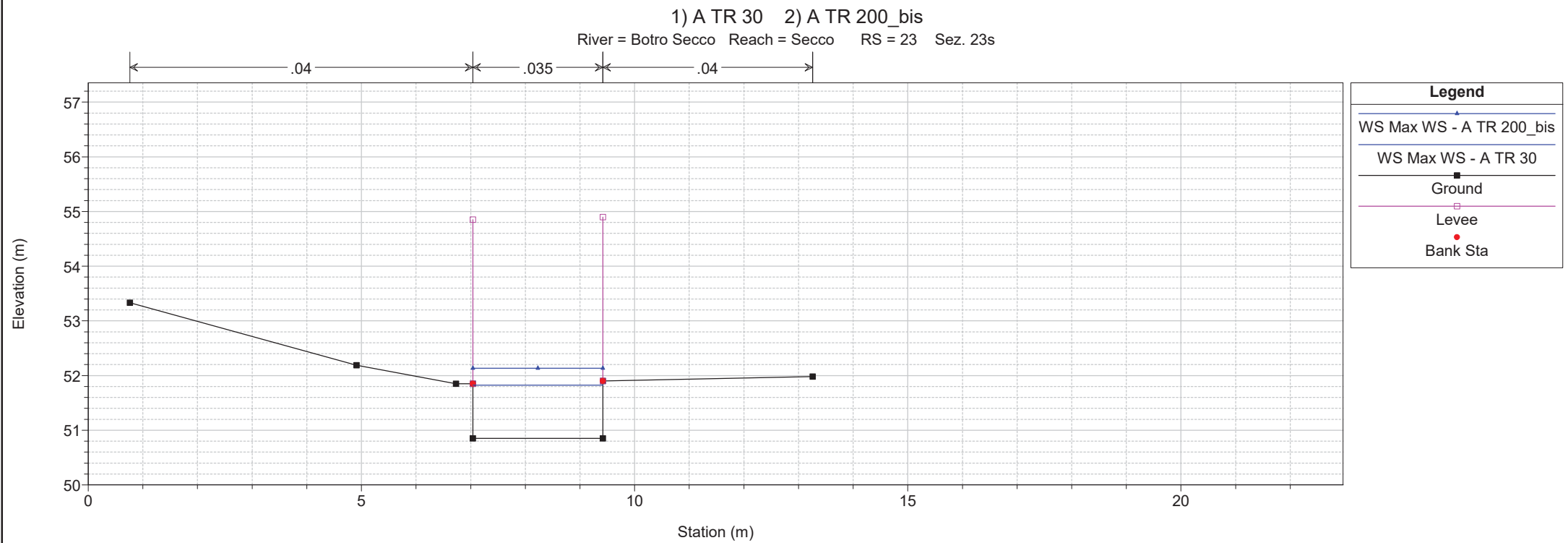
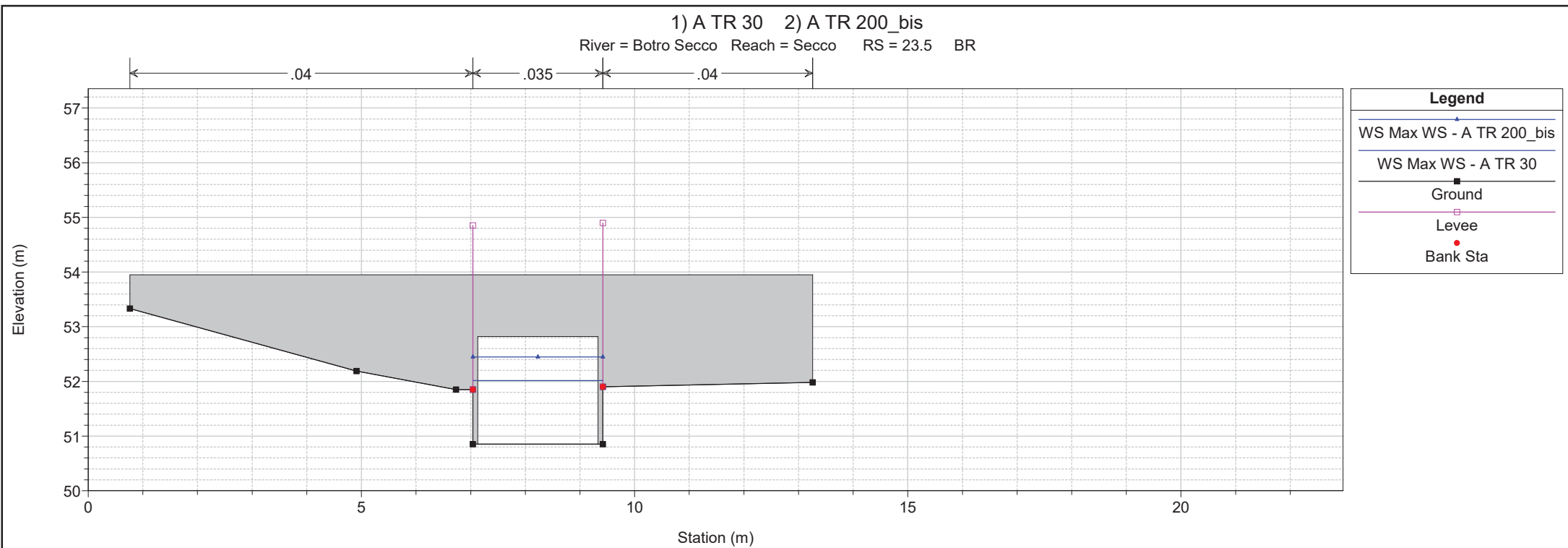

1) A TR 30 2) A TR 200_bis
 River = Botro Secco Reach = Secco RS = 22 Sez. 22s

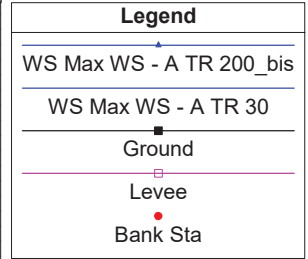
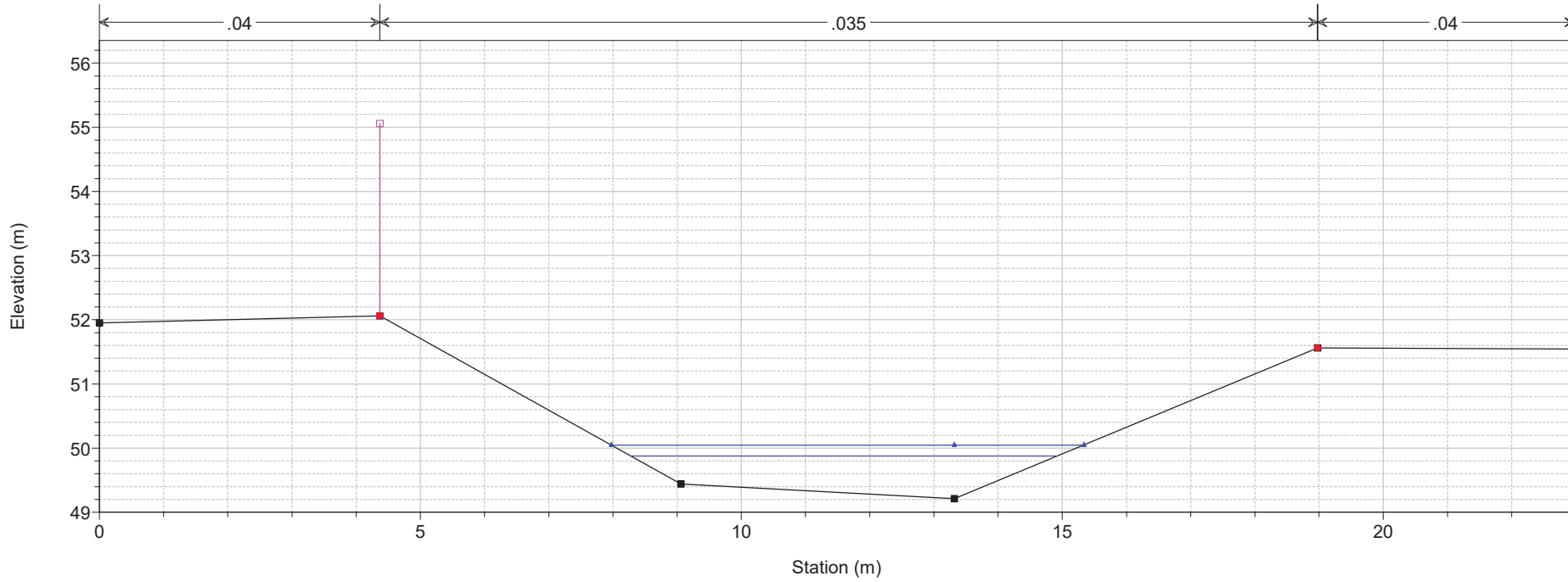

1) A TR 30 2) A TR 200_bis
 River = Botro Secco Reach = Secco RS = 21 Sez. 21s

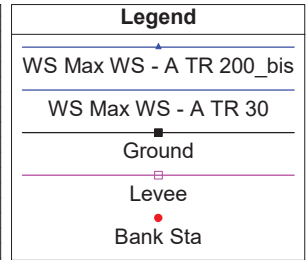
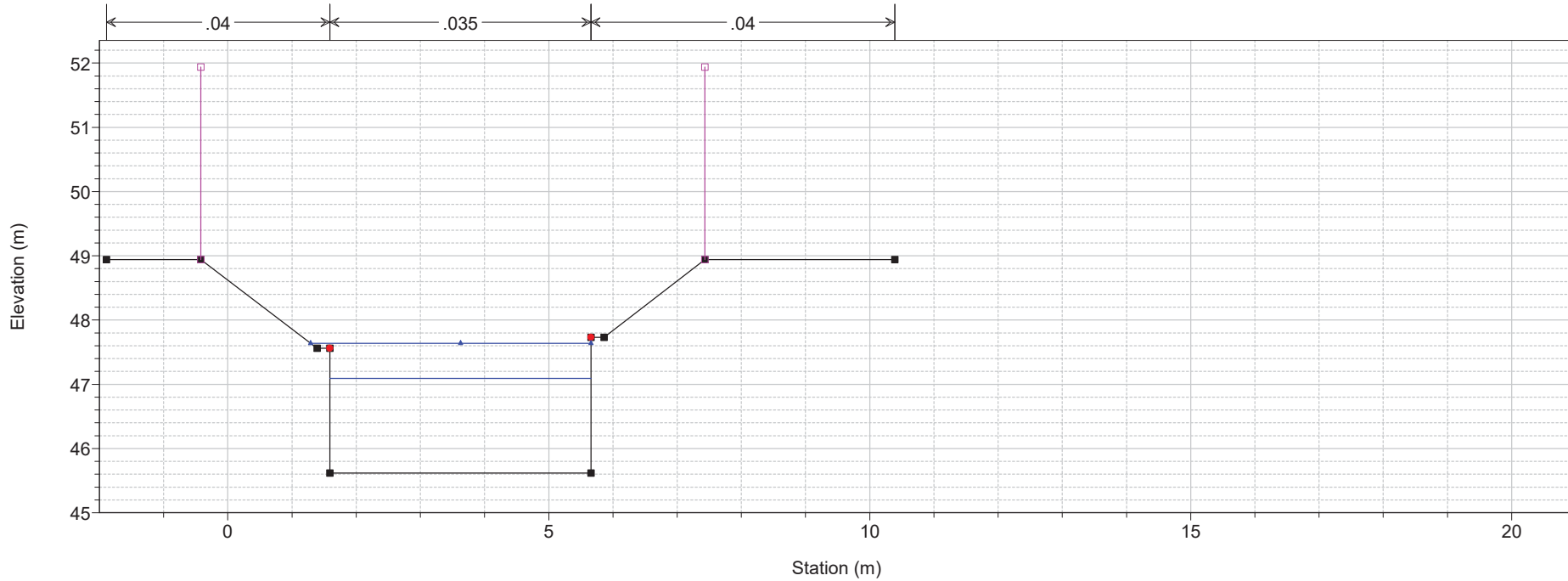

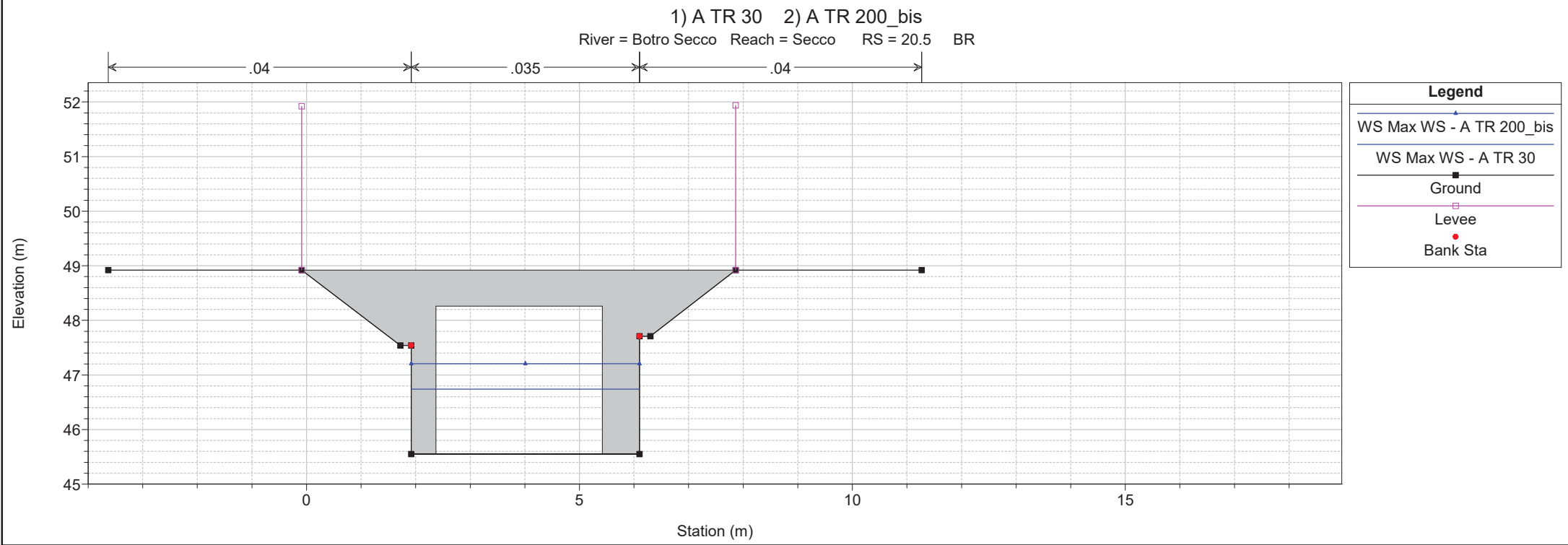
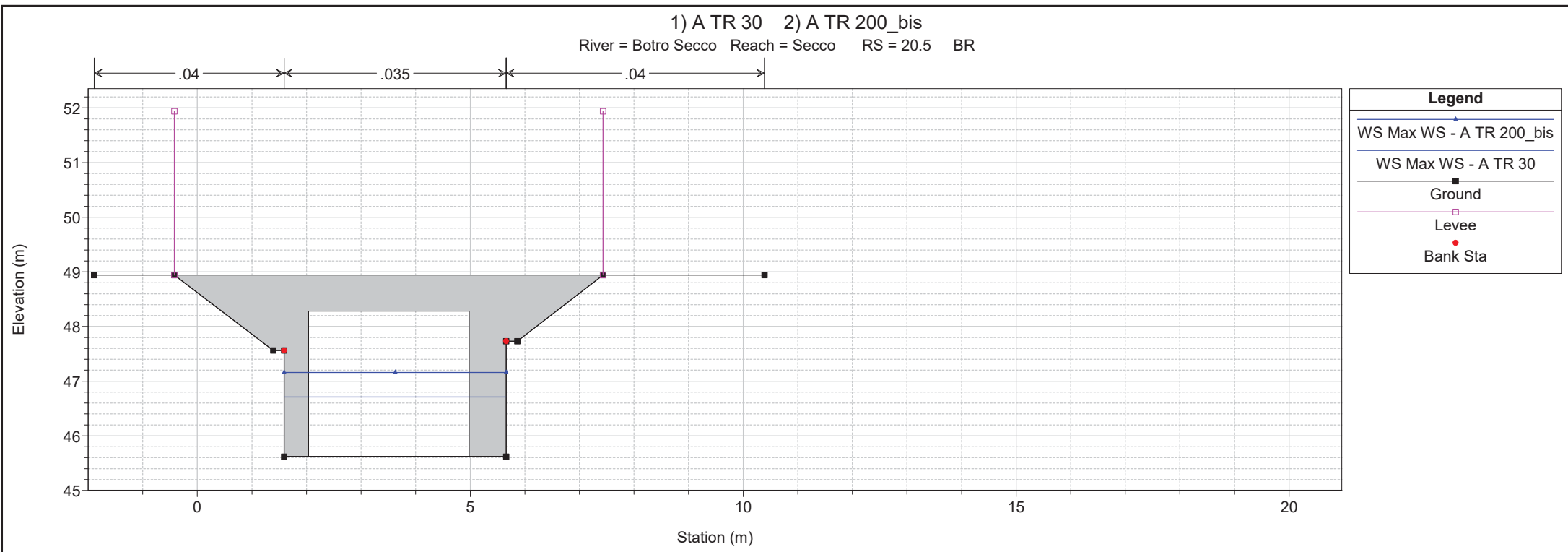

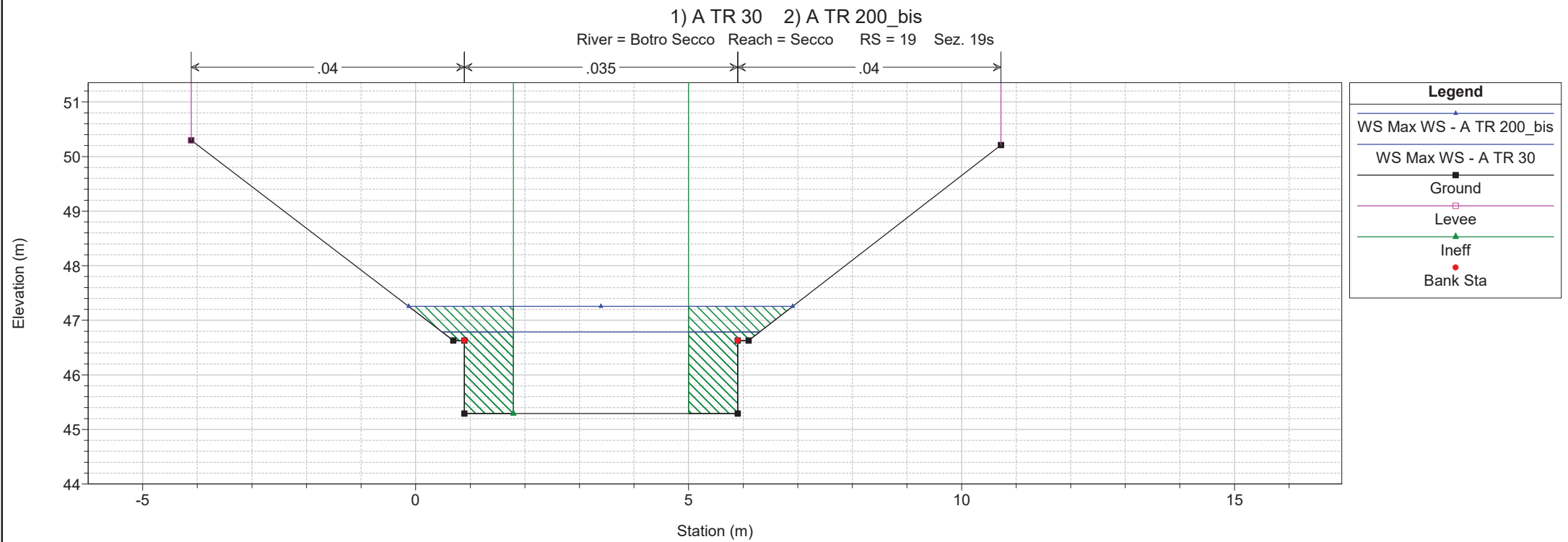
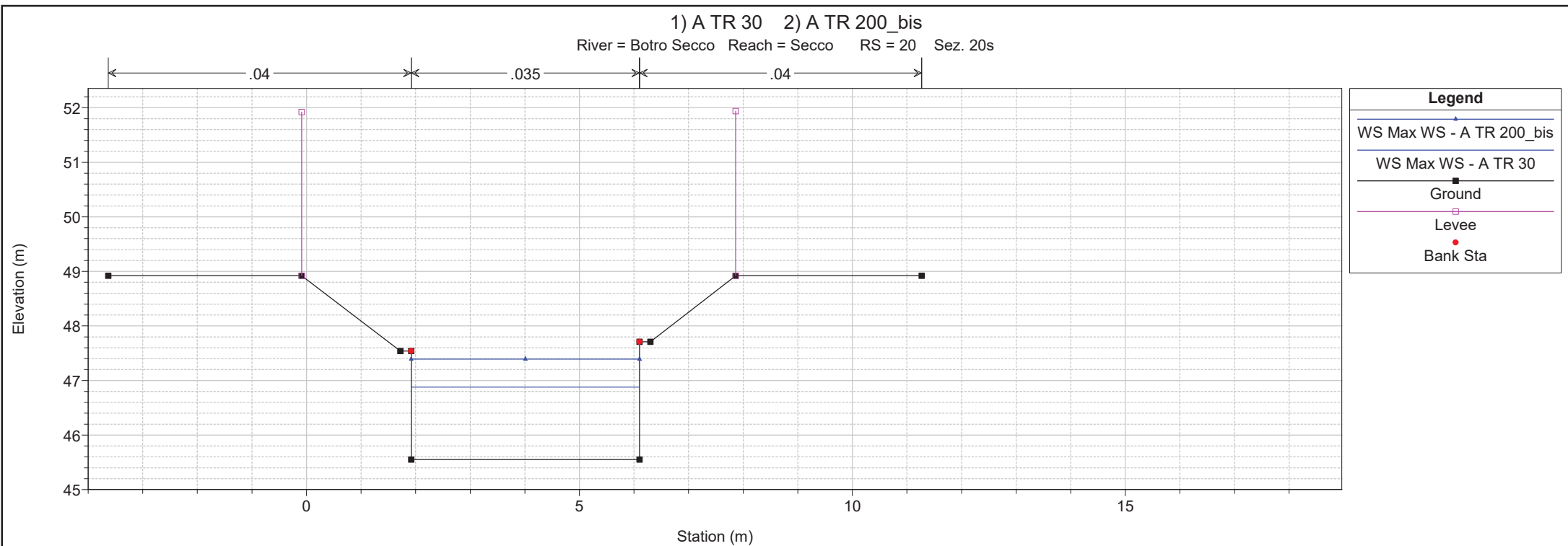

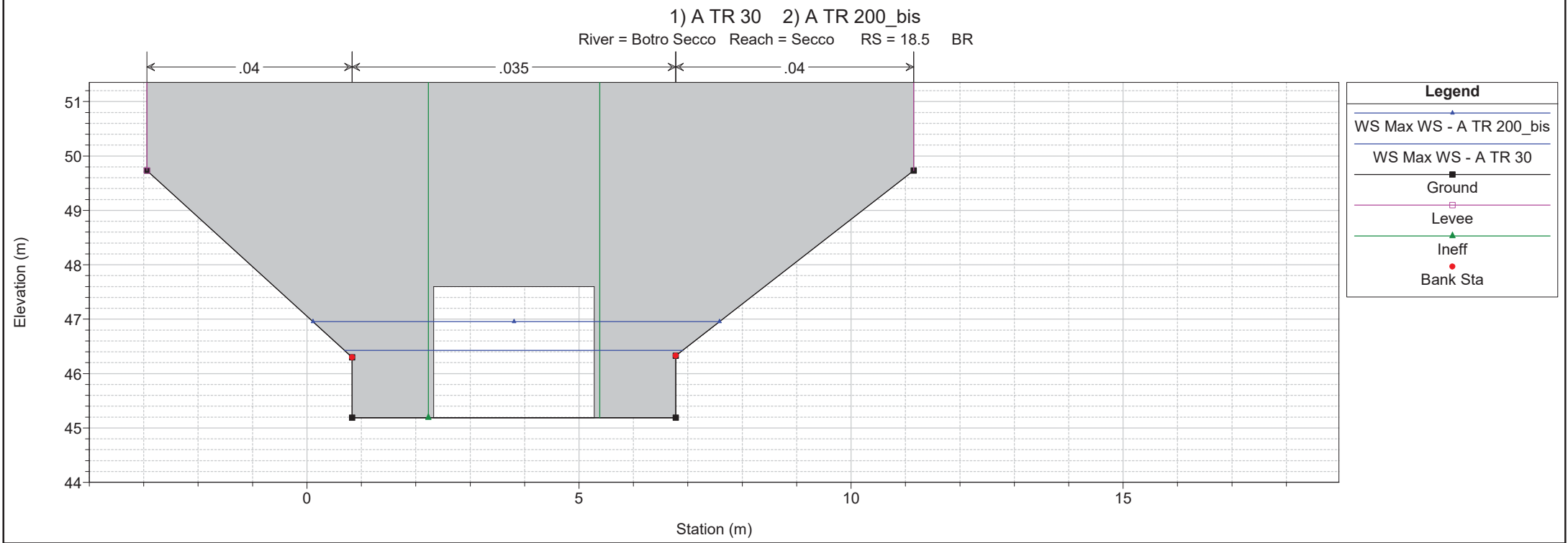
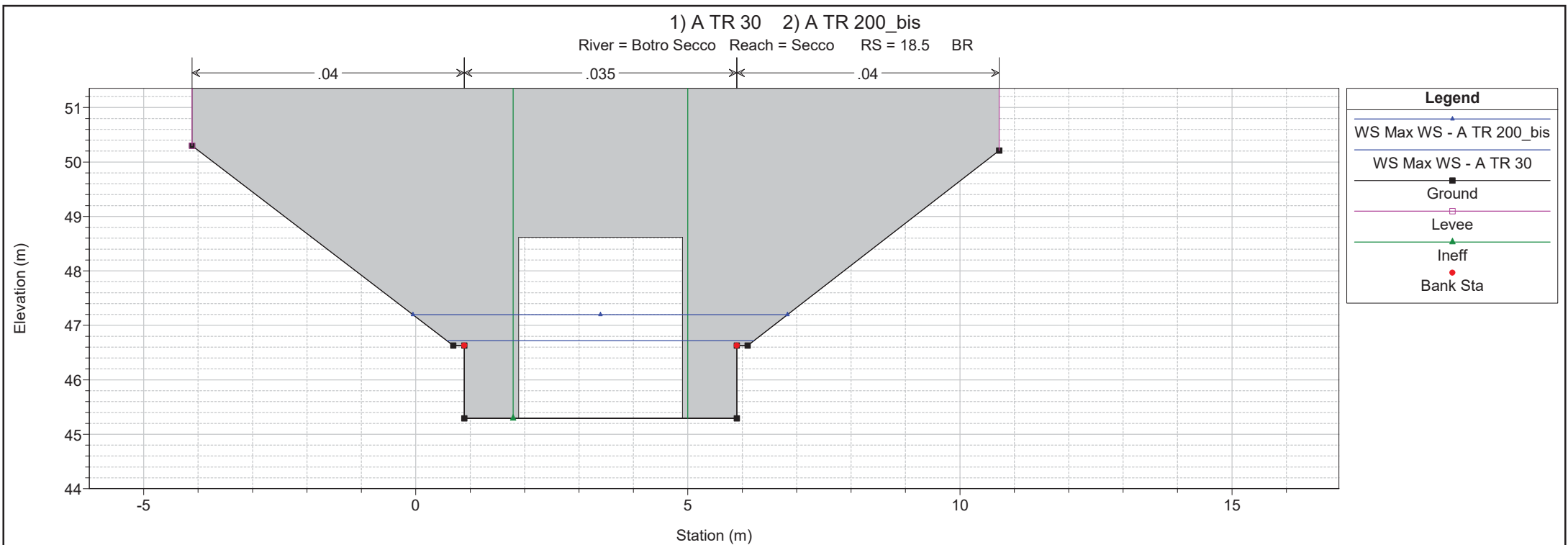

1 cm Horiz. = 1 m 1 cm Vert. = 1 m

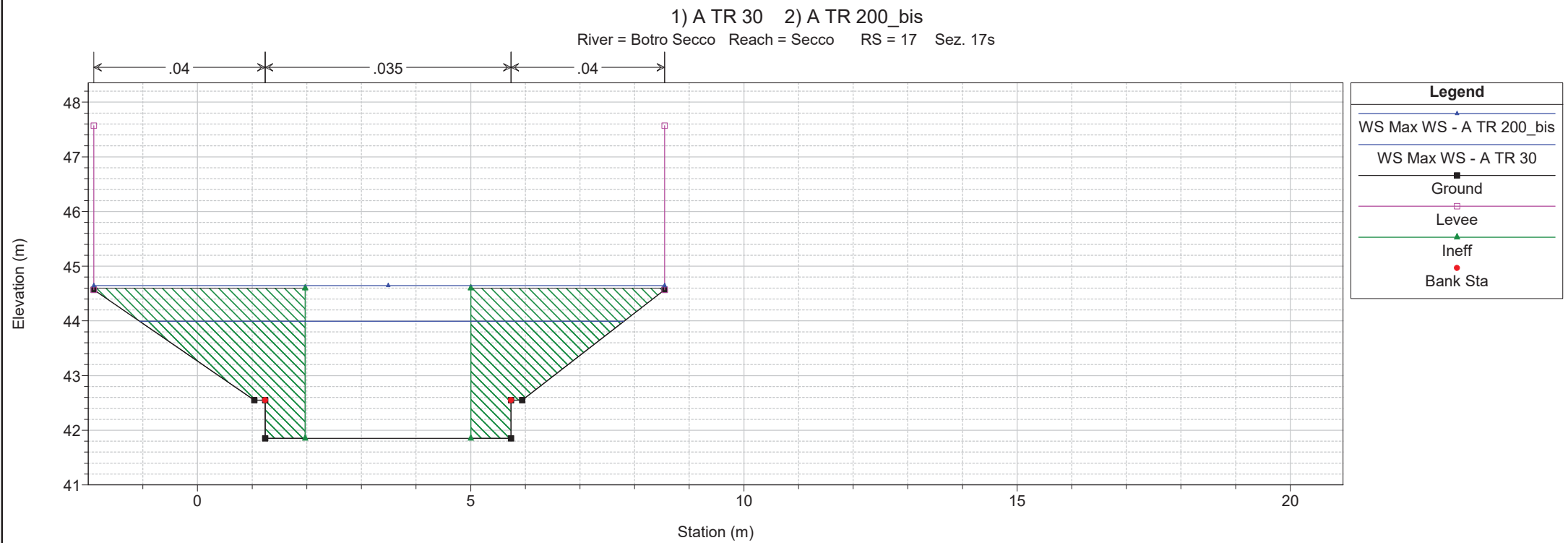
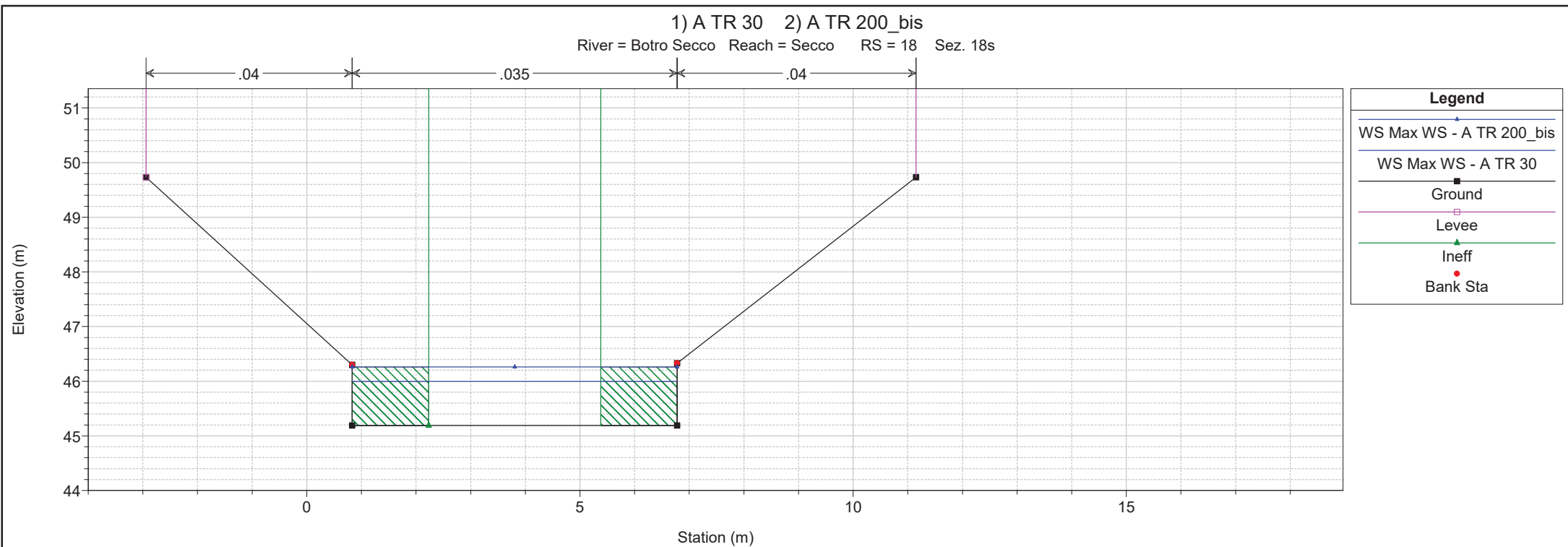

1) A TR 30 2) A TR 200_bis

River = Botro Secco Reach = Secco RS = 16.5 BR

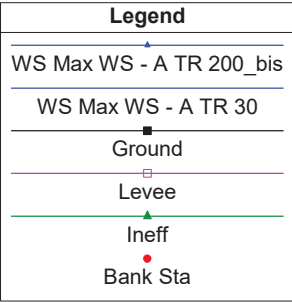
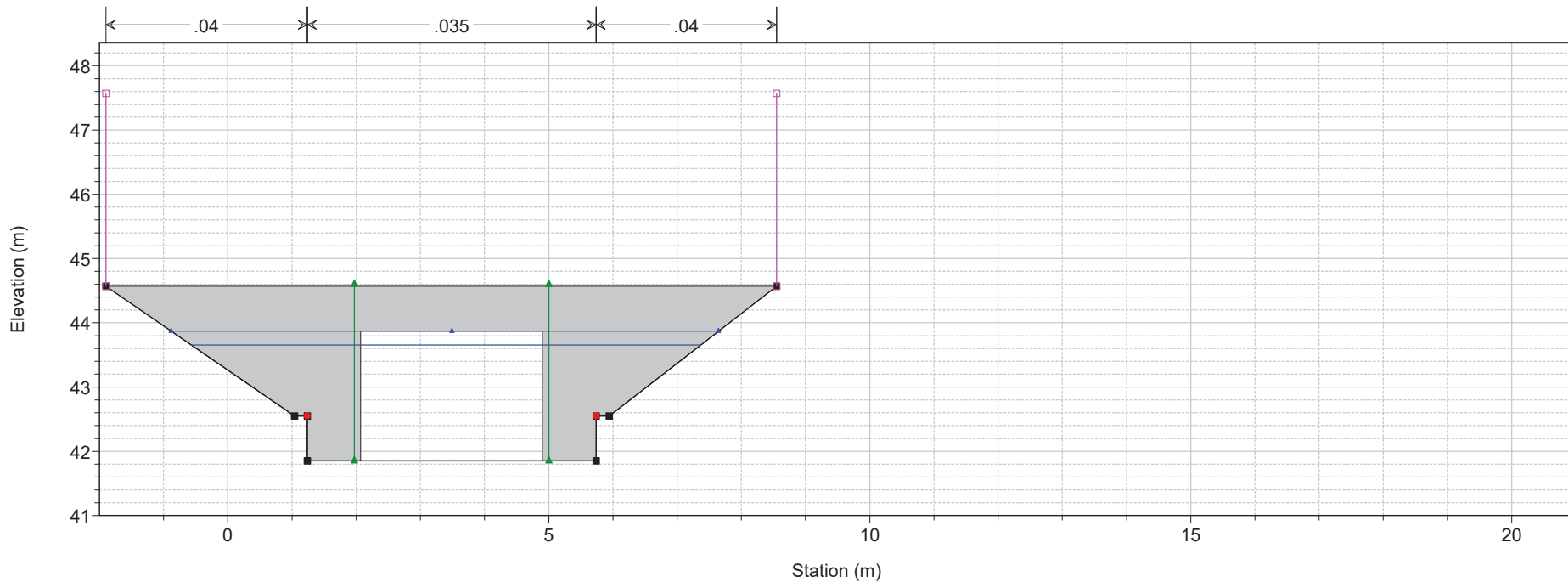

1) A TR 30 2) A TR 200_bis

River = Botro Secco Reach = Secco RS = 16.5 BR

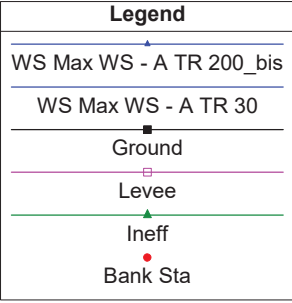
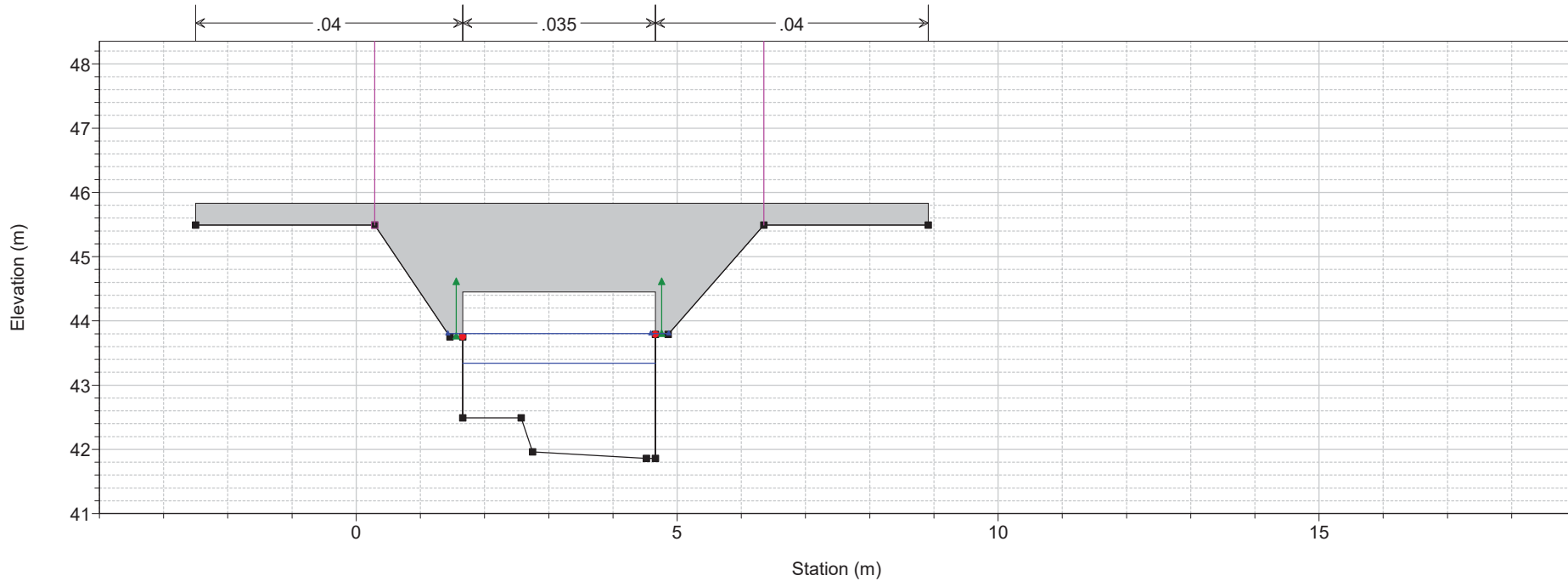

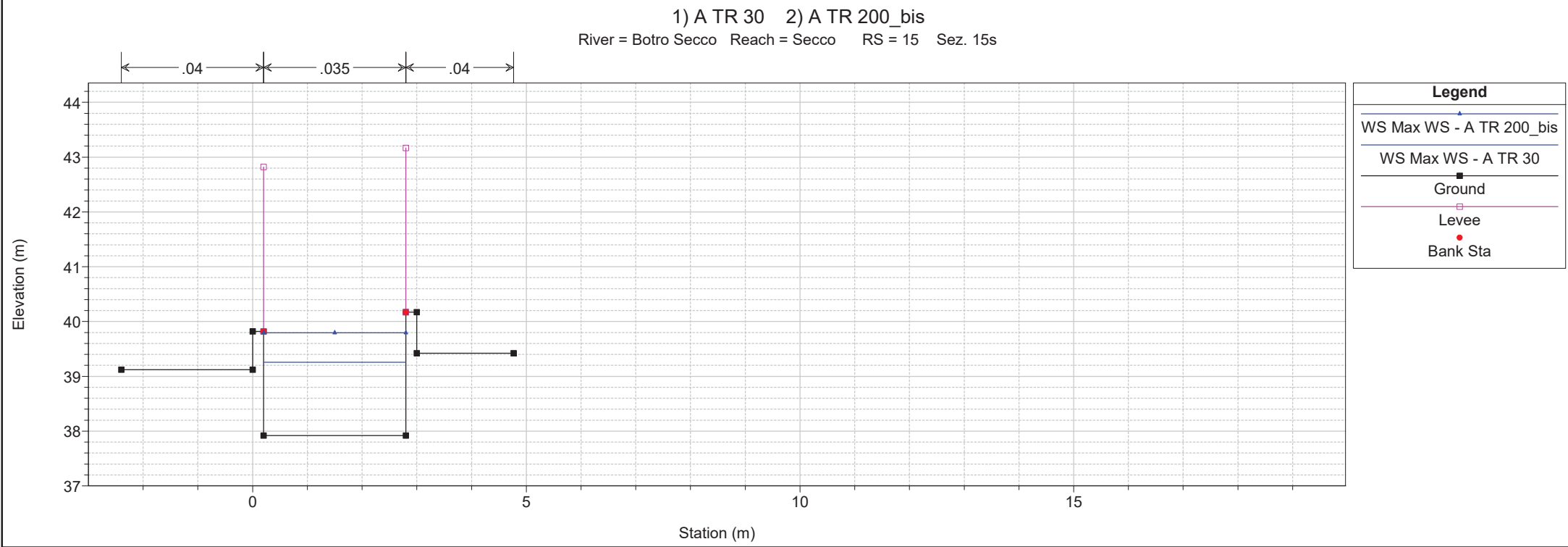
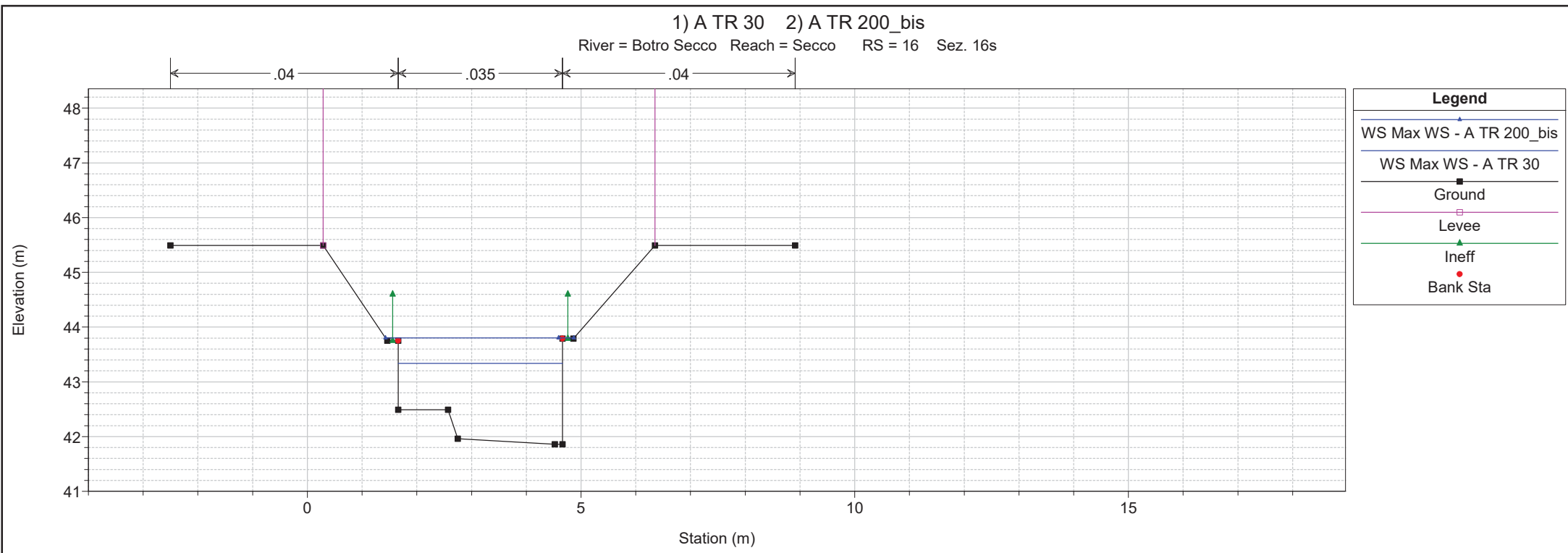

1 cm Horiz. = 1 m 1 cm Vert. = 1 m

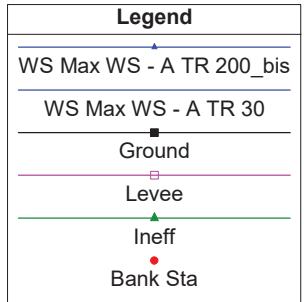
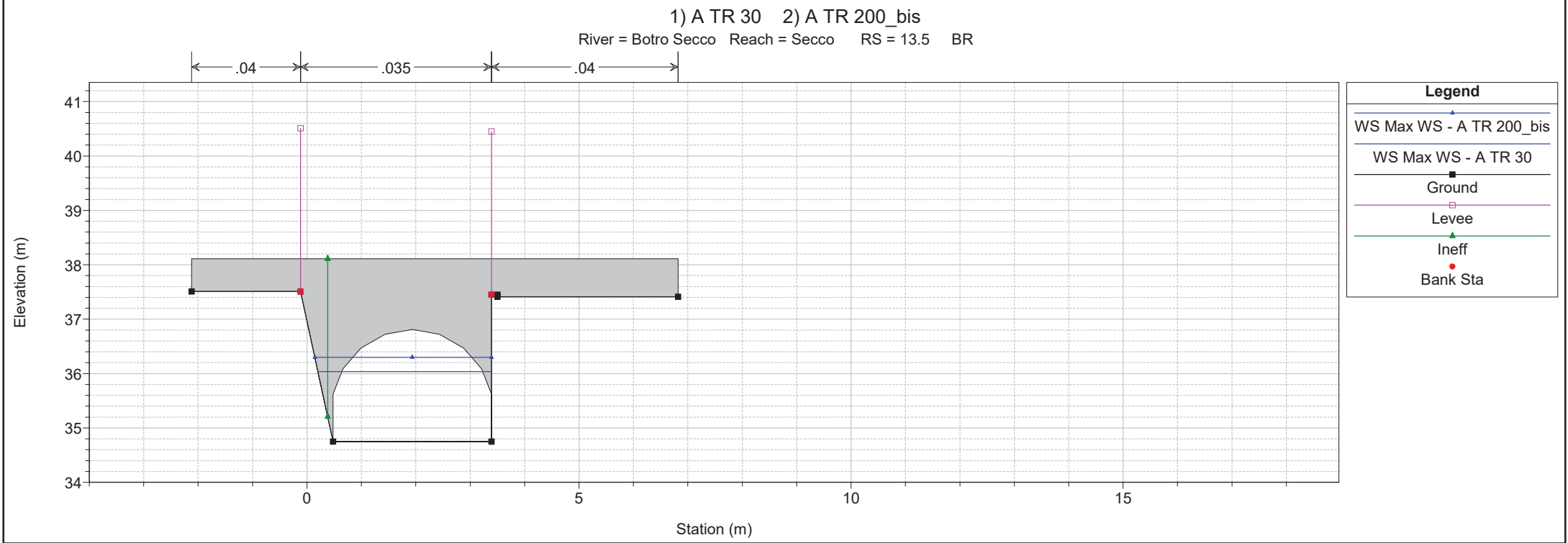
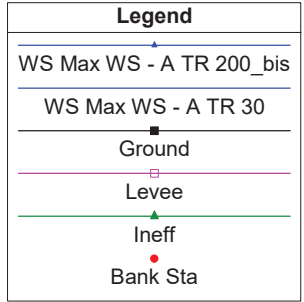
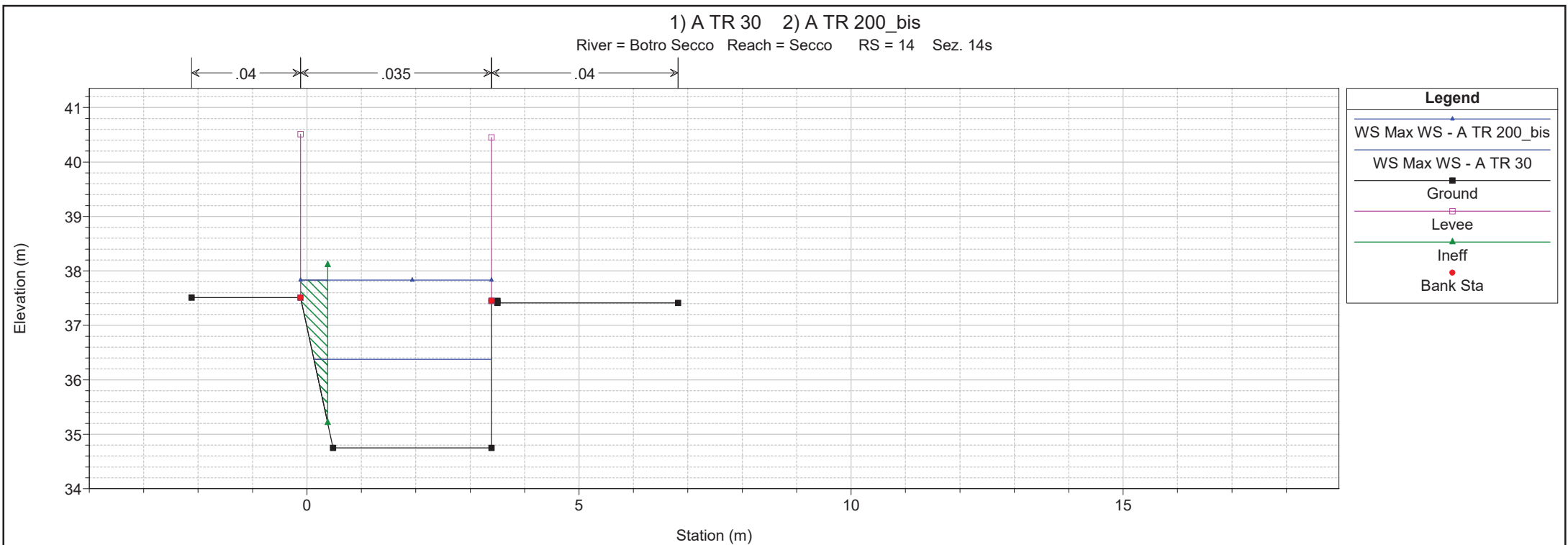

1 cm Horiz. = 1 m 1 cm Vert. = 1 m

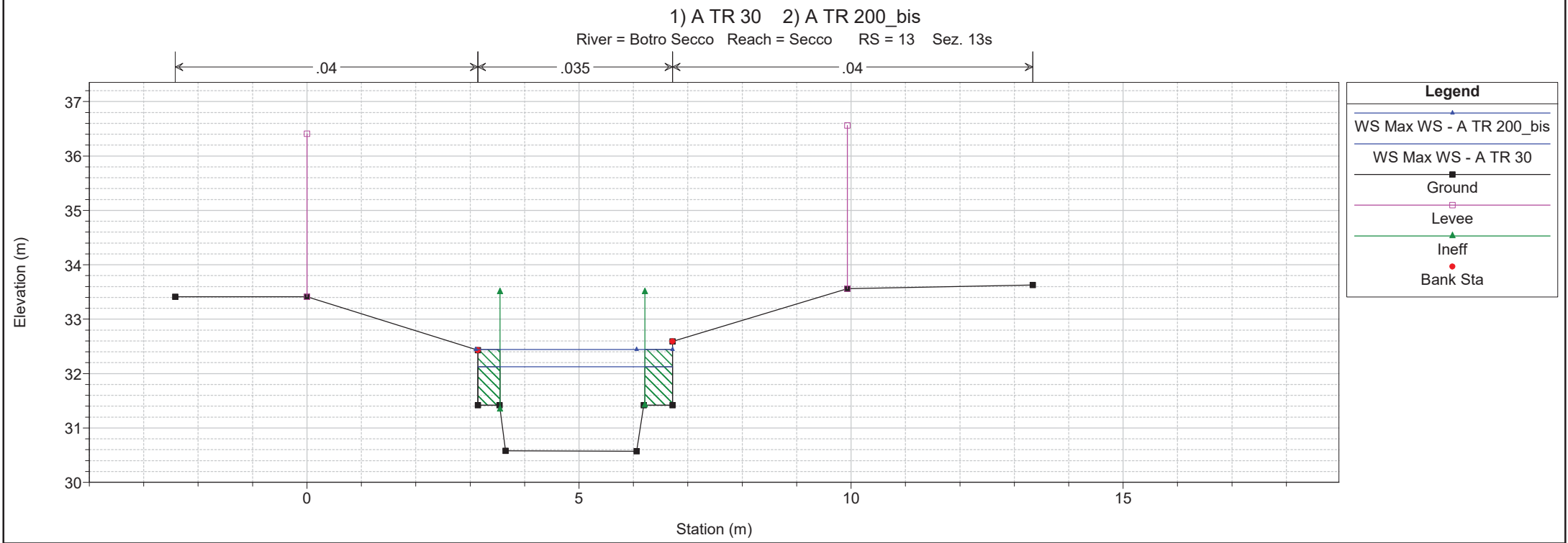
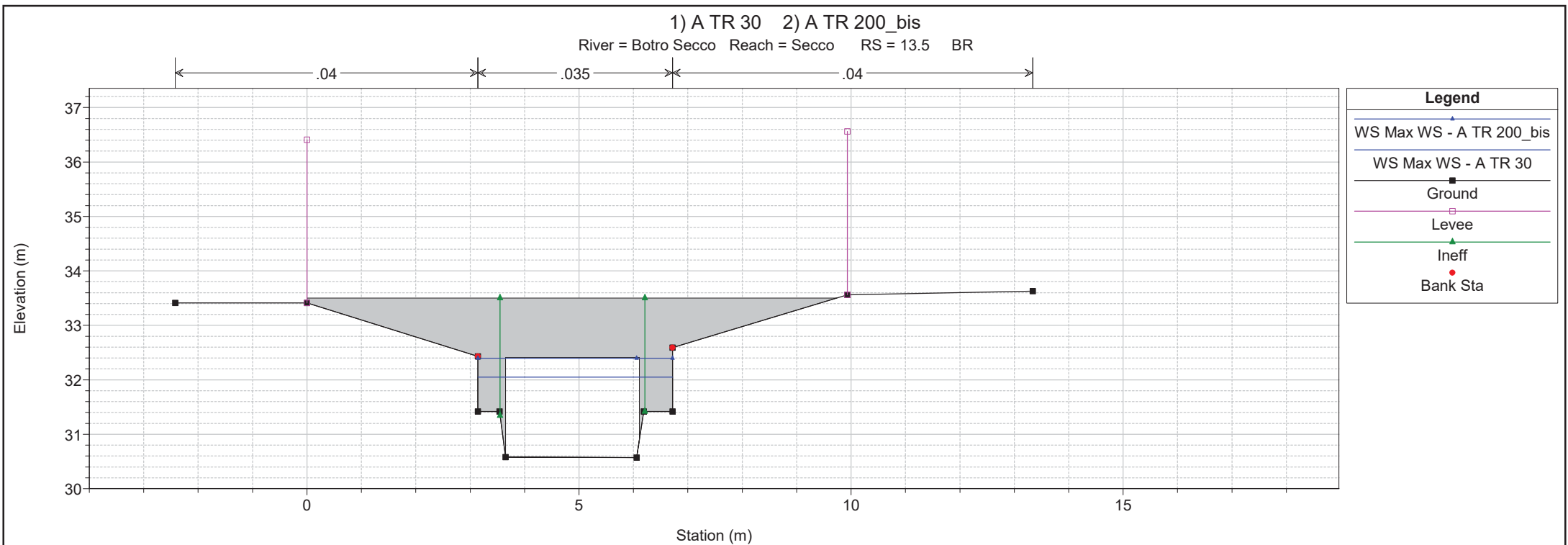

1 cm Horiz. = 1 m 1 cm Vert. = 1 m

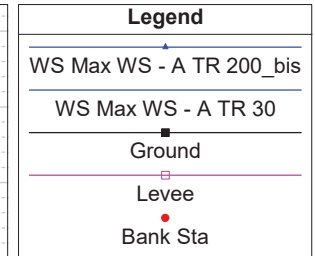
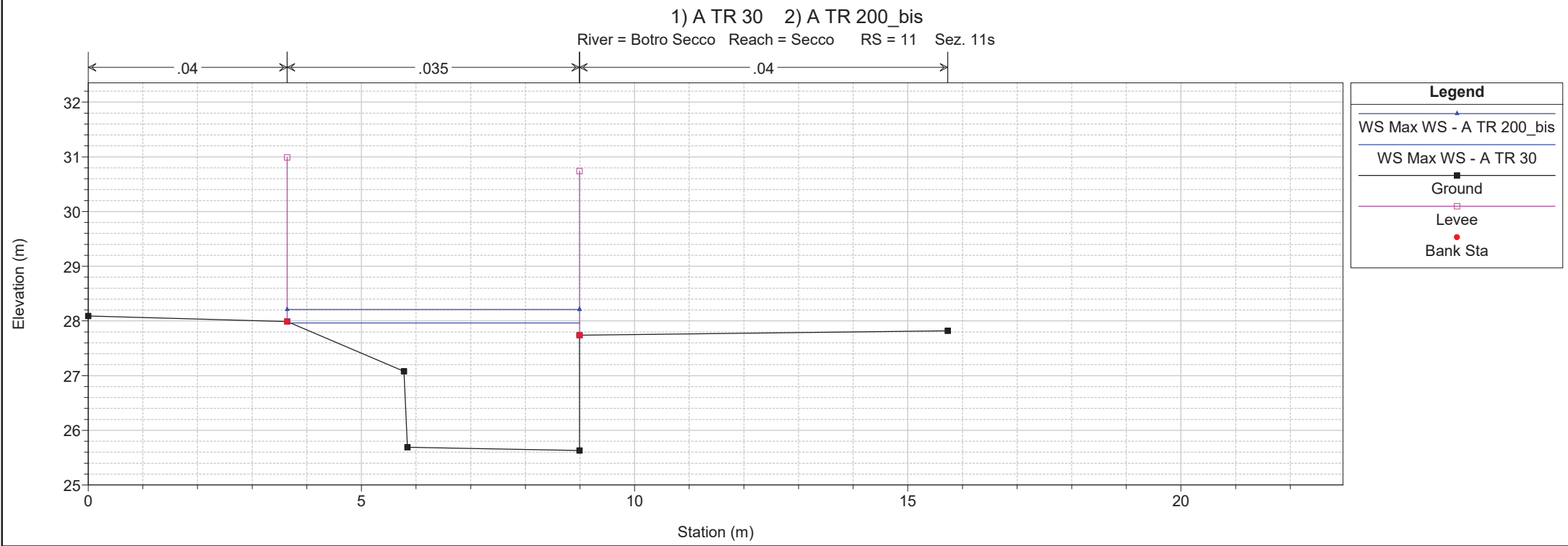
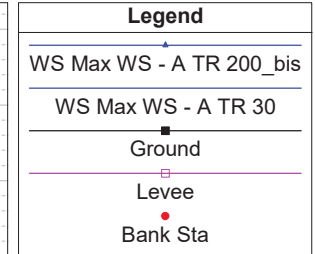
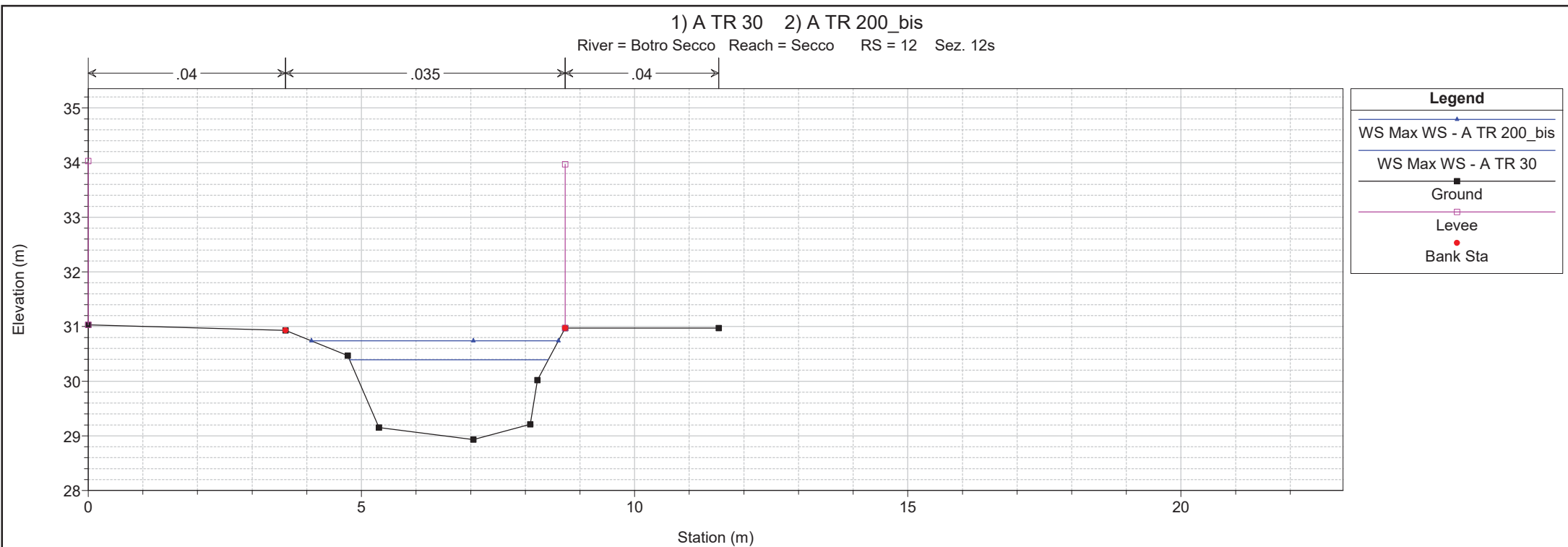

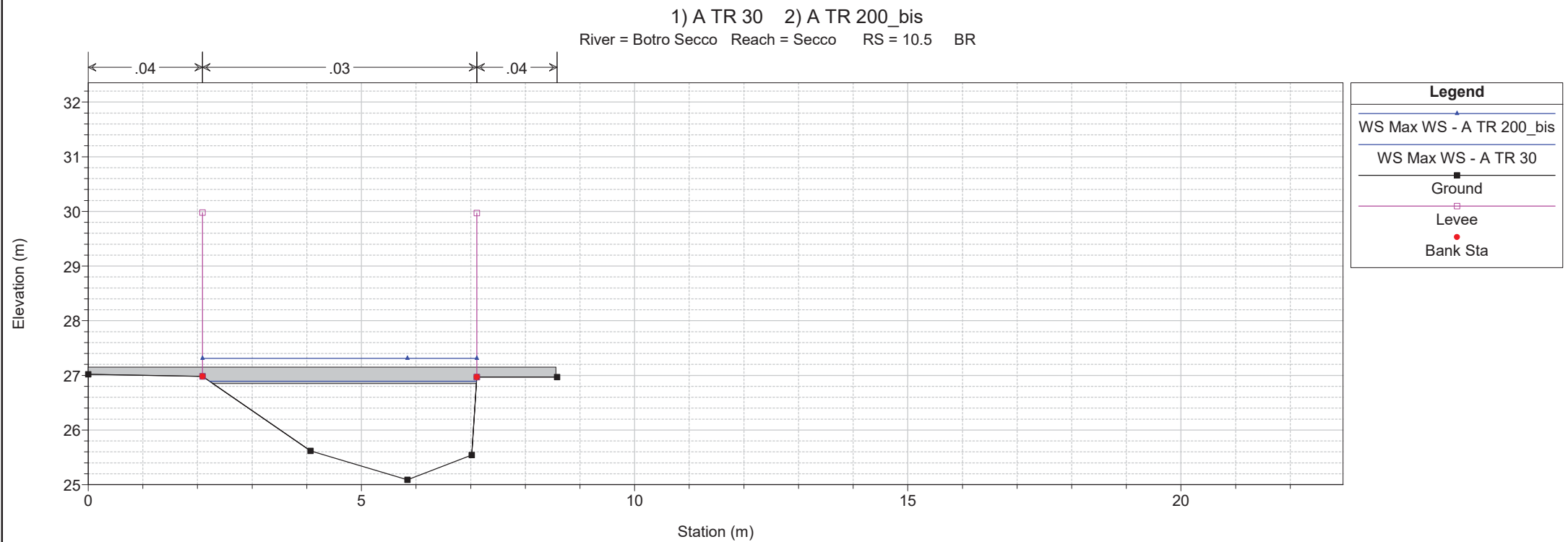
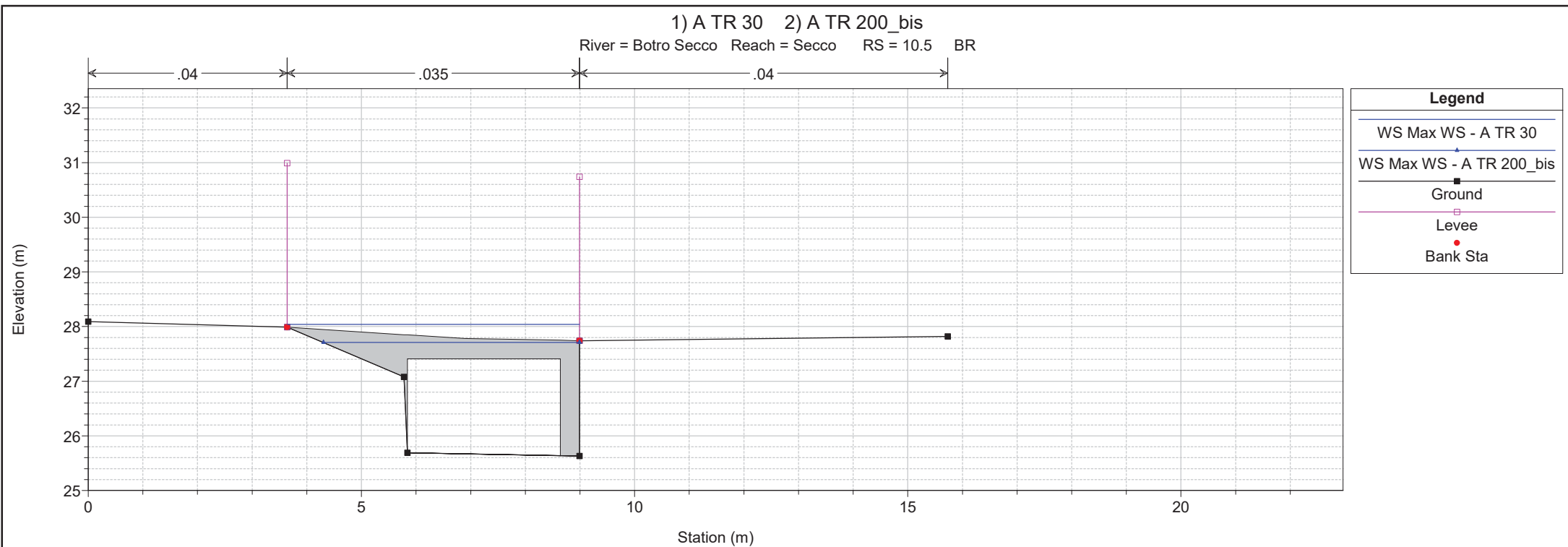

1) A TR 30 2) A TR 200_bis
 River = Botro Secco Reach = Secco RS = 10 Sez. 10s

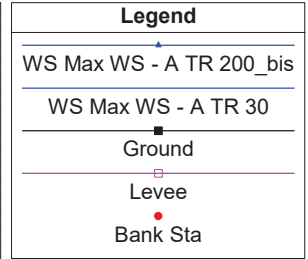
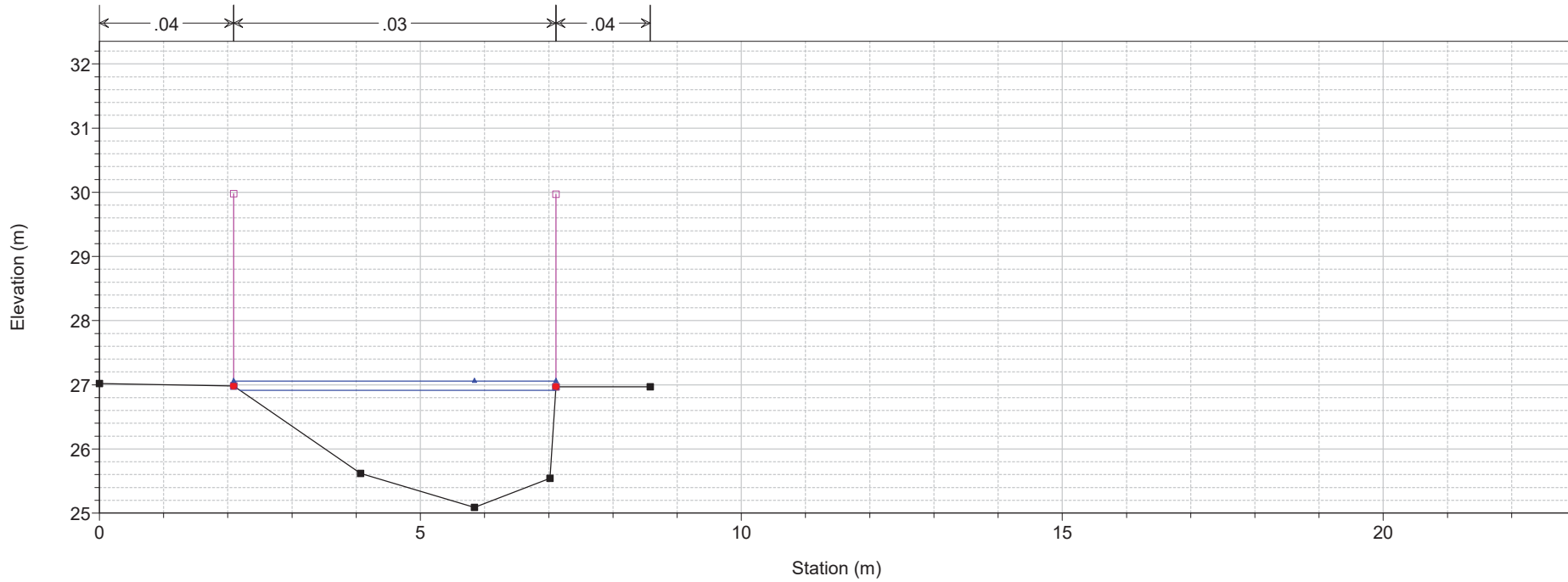

1) A TR 30 2) A TR 200_bis
 River = Botro Secco Reach = Secco RS = 9.7

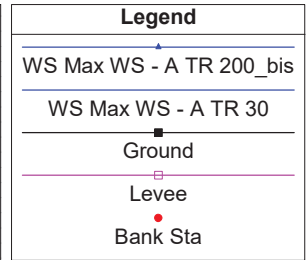
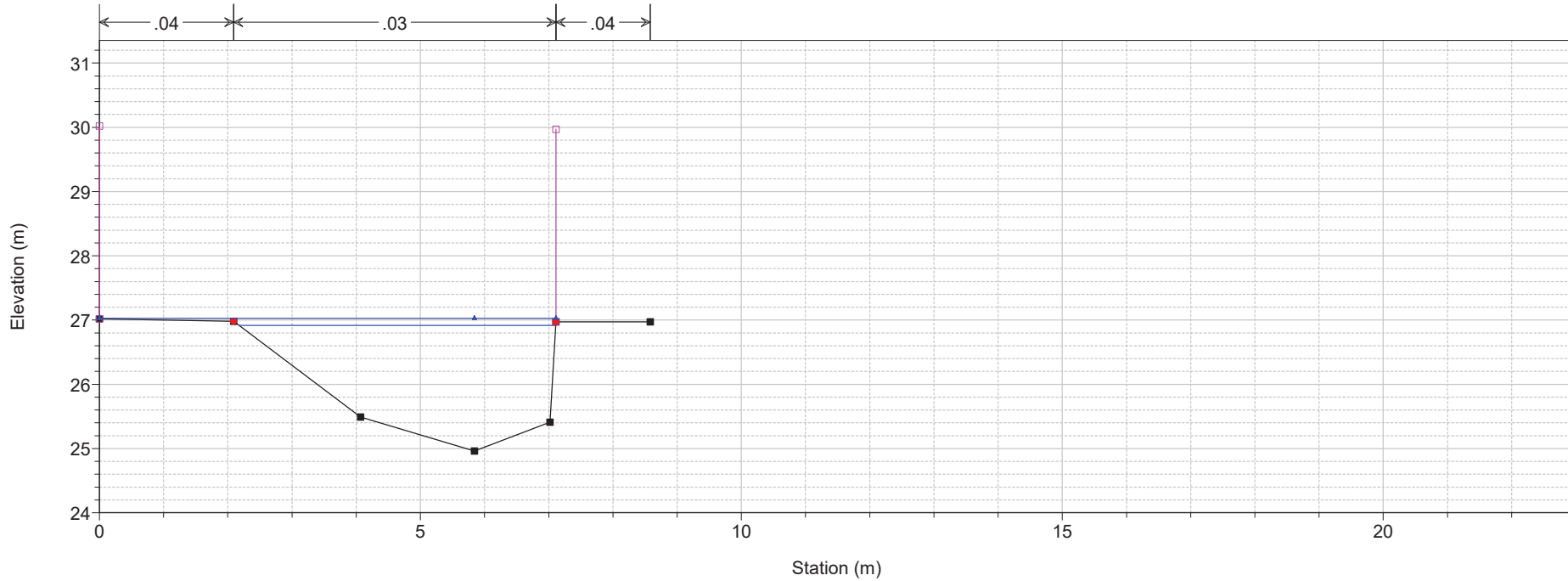

1) A TR 30 2) A TR 200_bis
 River = Botro Secco Reach = Secco RS = 9.5 IS

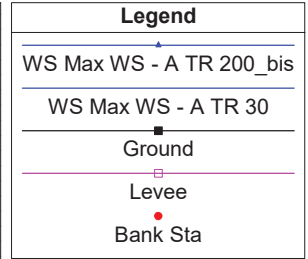
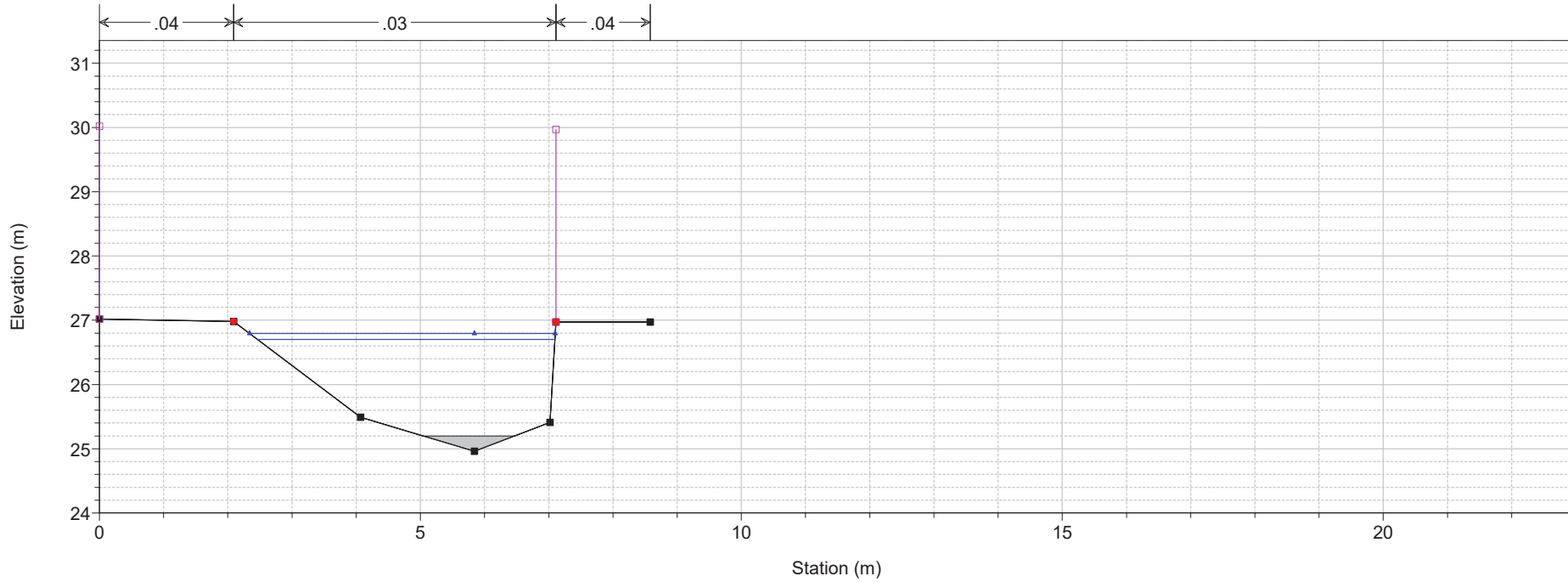

1) A TR 30 2) A TR 200_bis
 River = Botro Secco Reach = Secco RS = 9.3

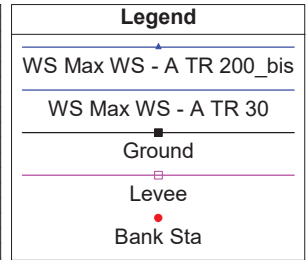
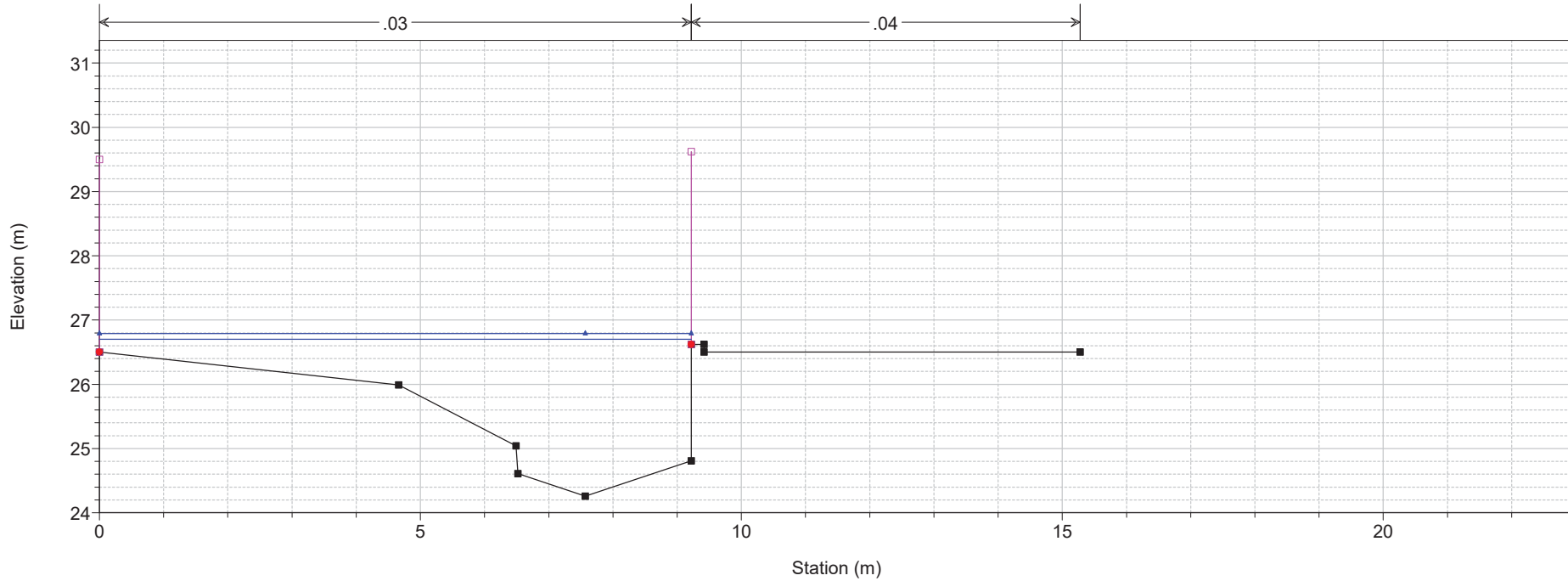

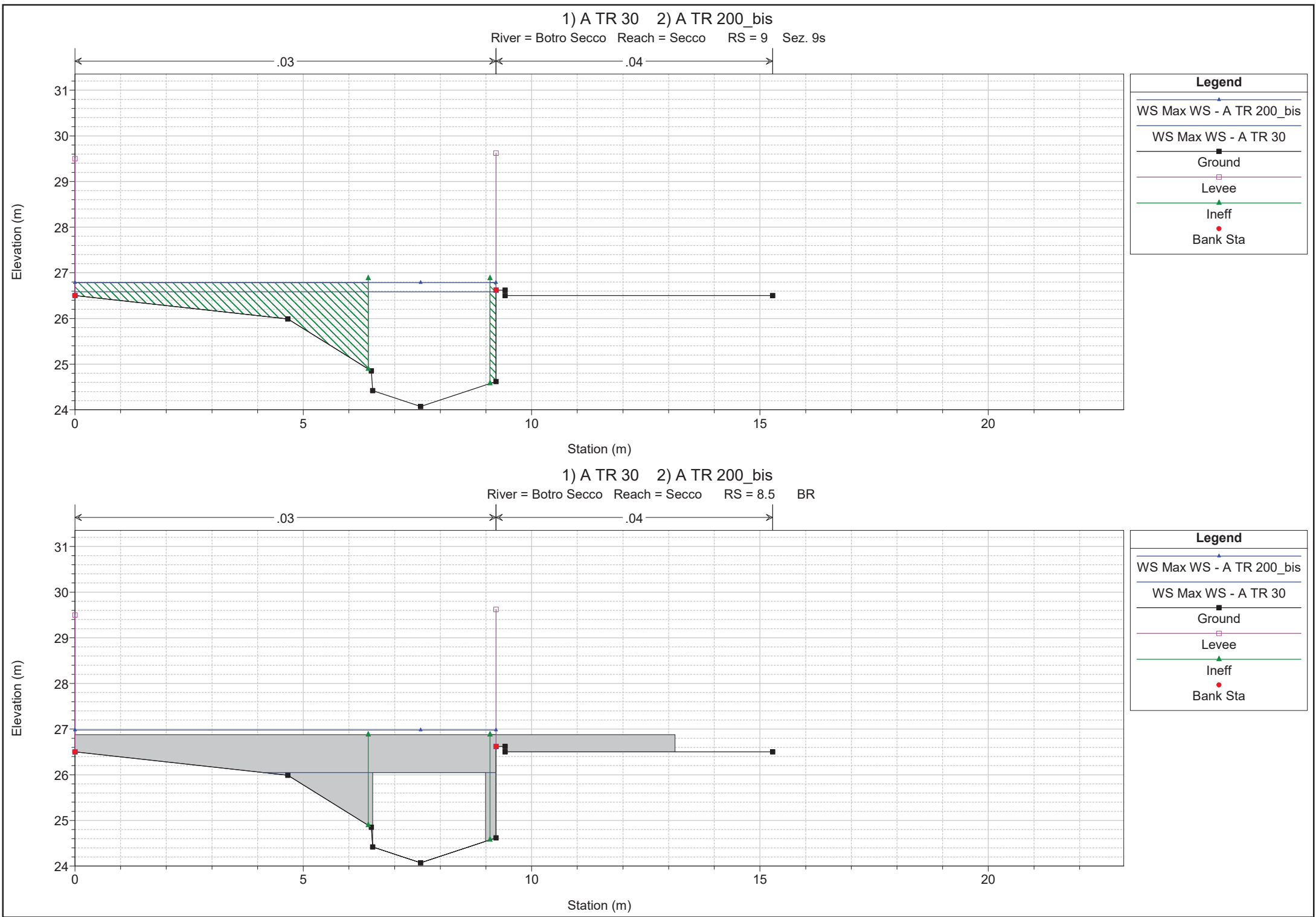

1 cm Horiz. = 1 m 1 cm Vert. = 1 m

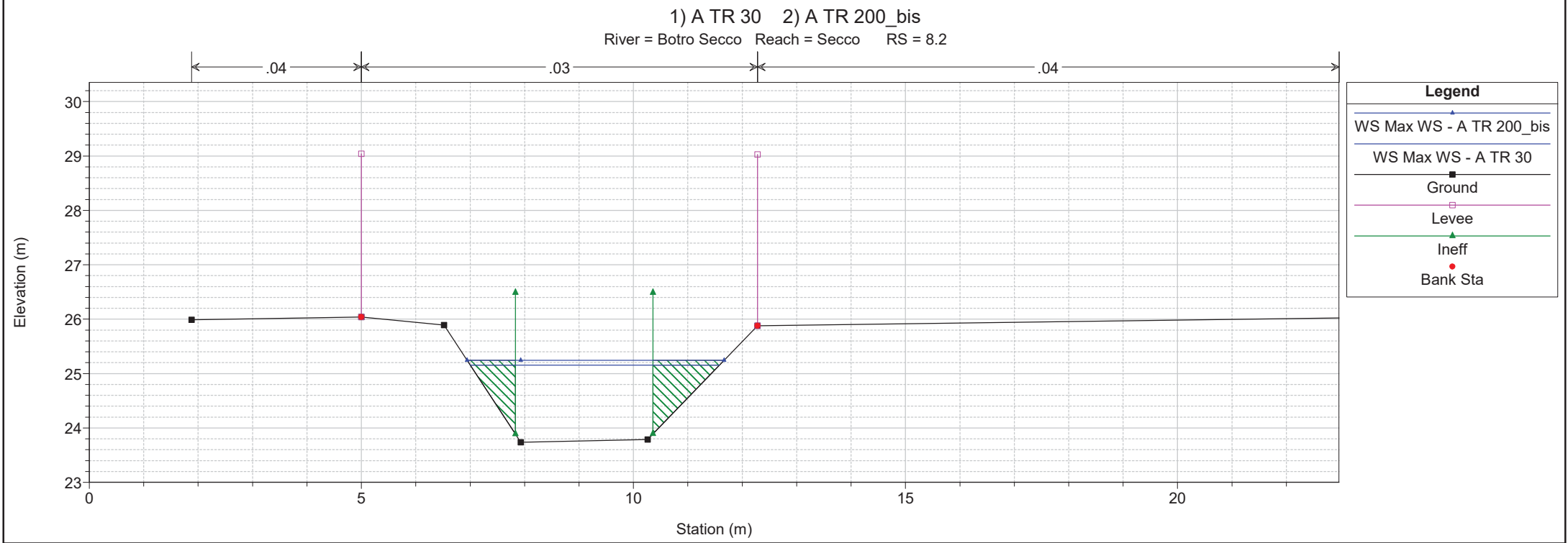
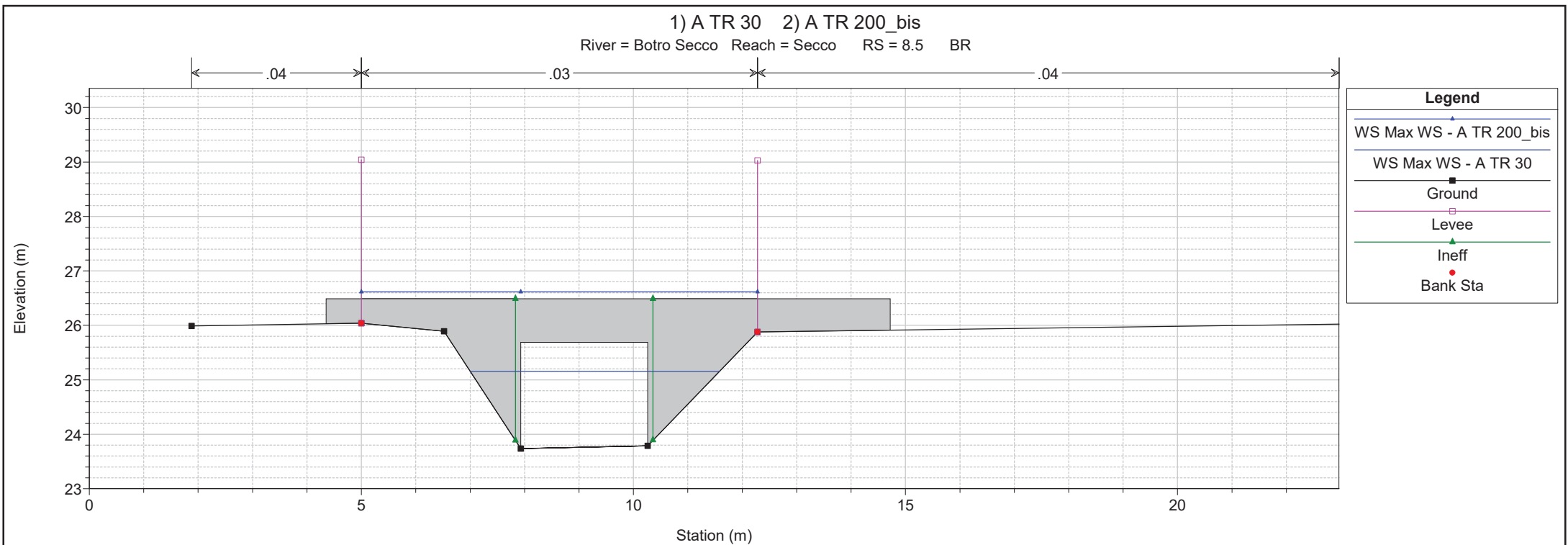

1 cm Horiz. = 1 m 1 cm Vert. = 1 m

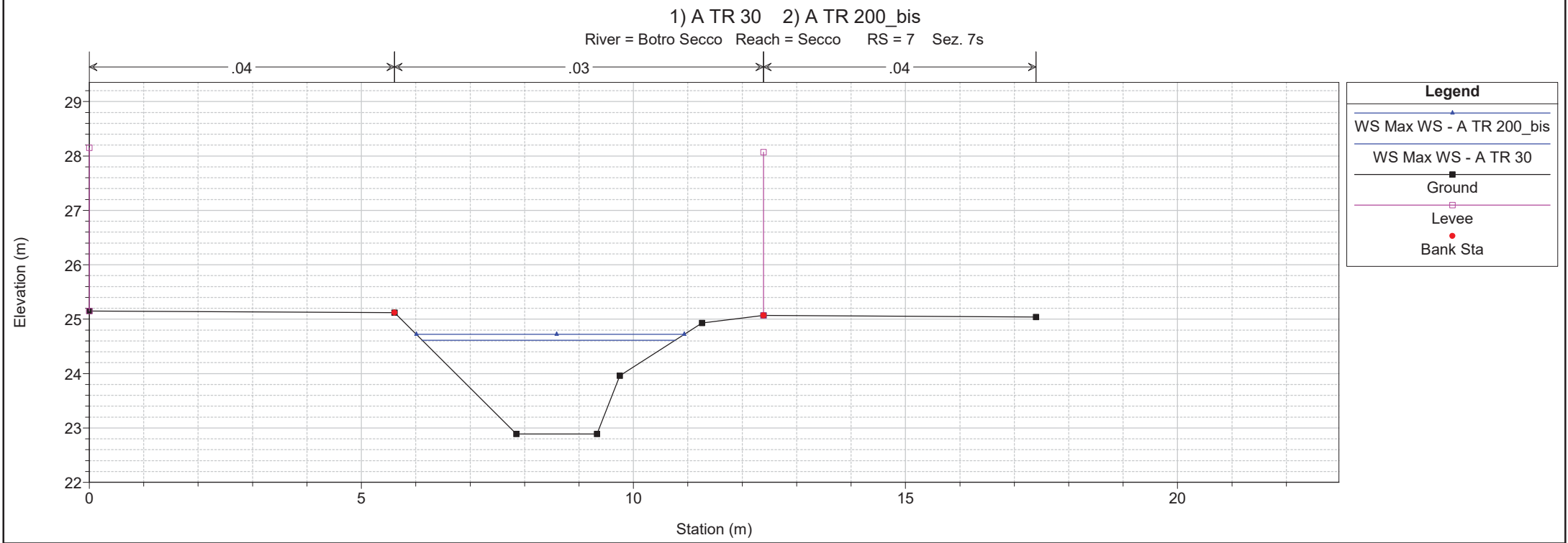
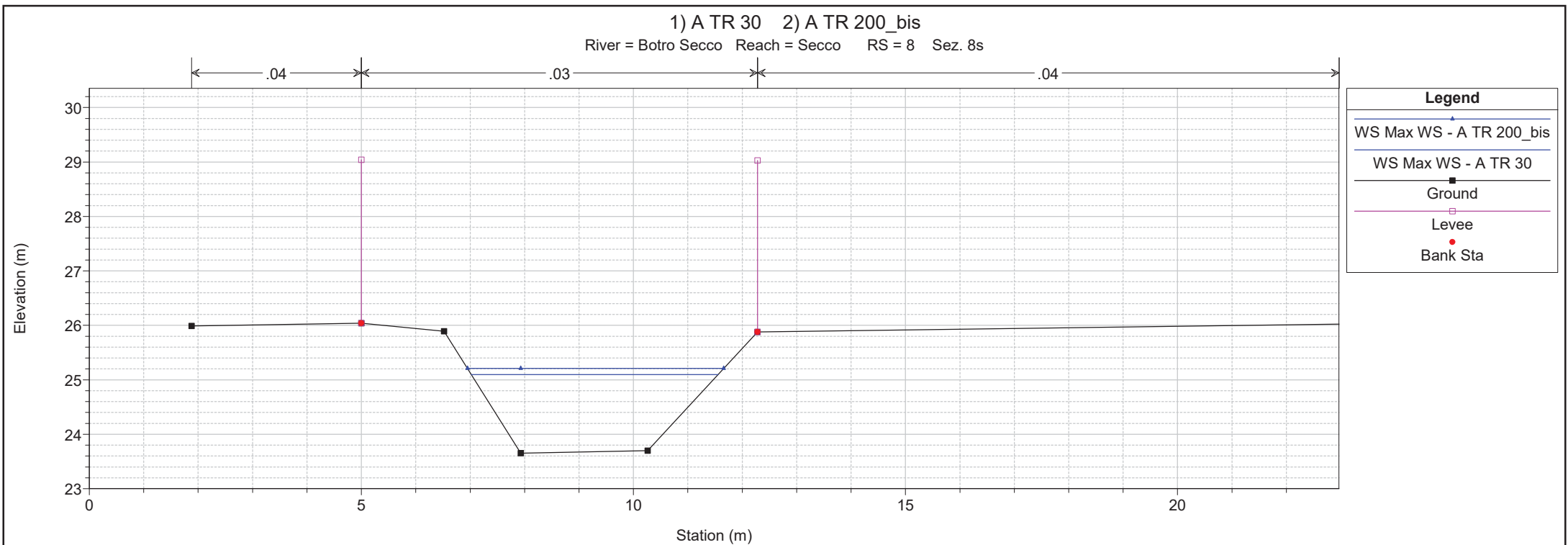

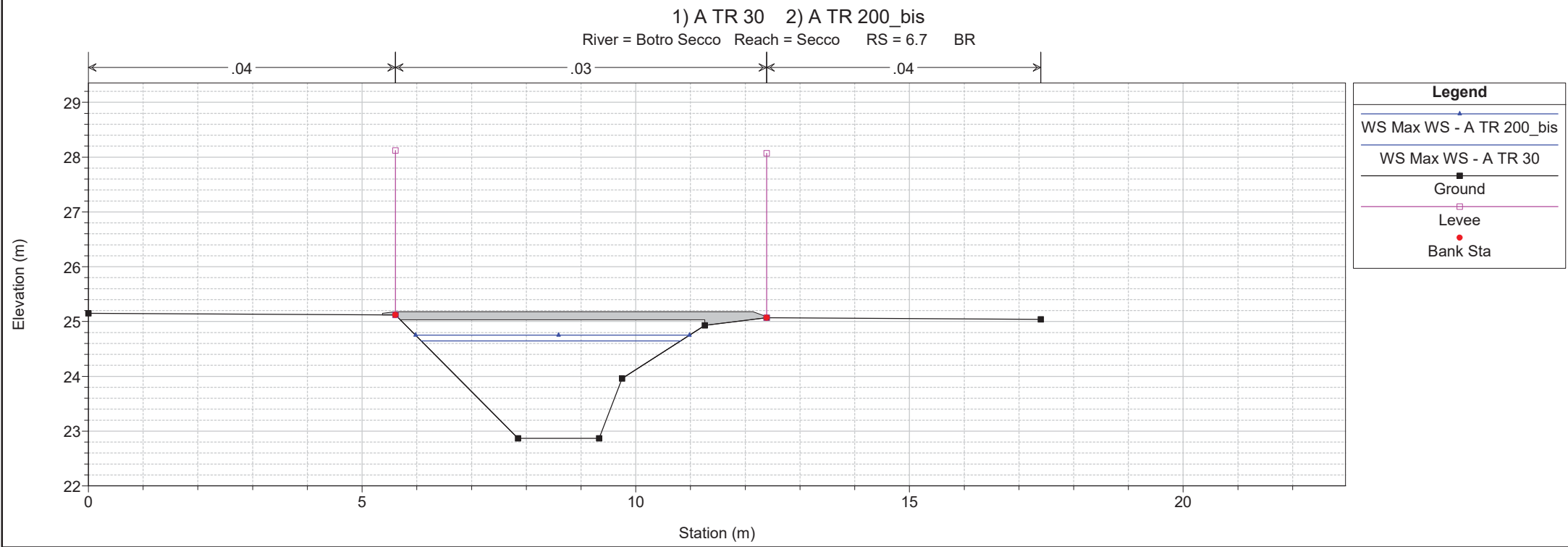
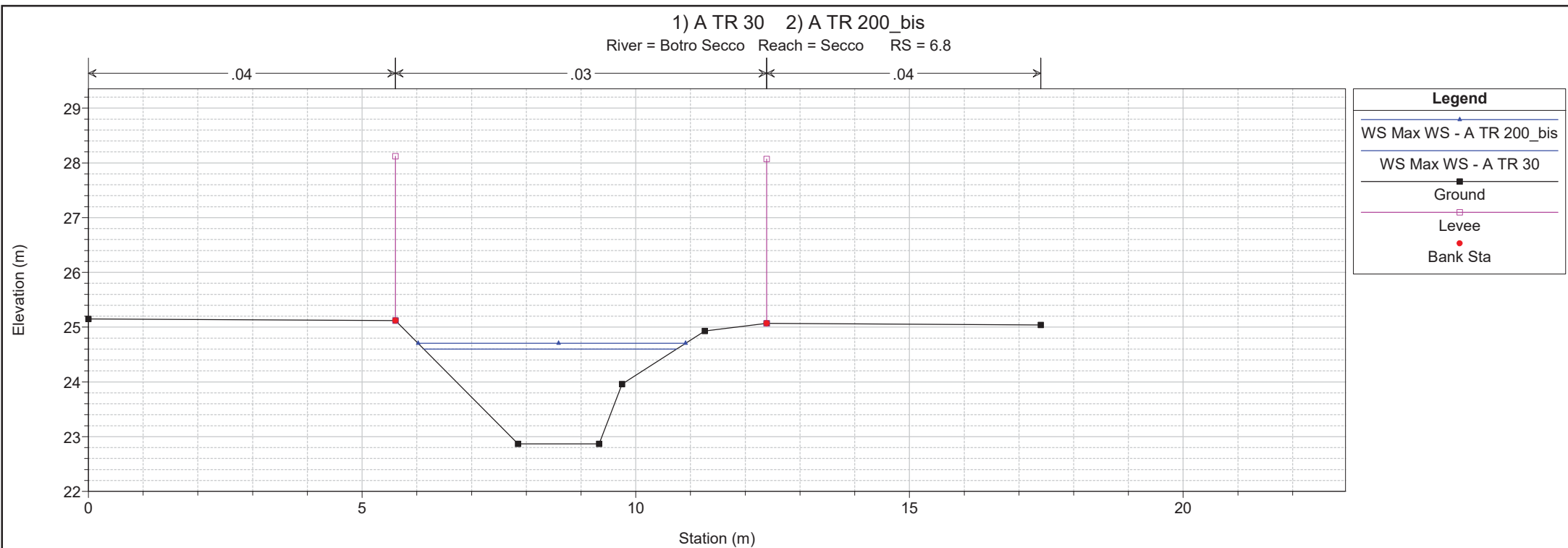

1 cm Horiz. = 1 m 1 cm Vert. = 1 m

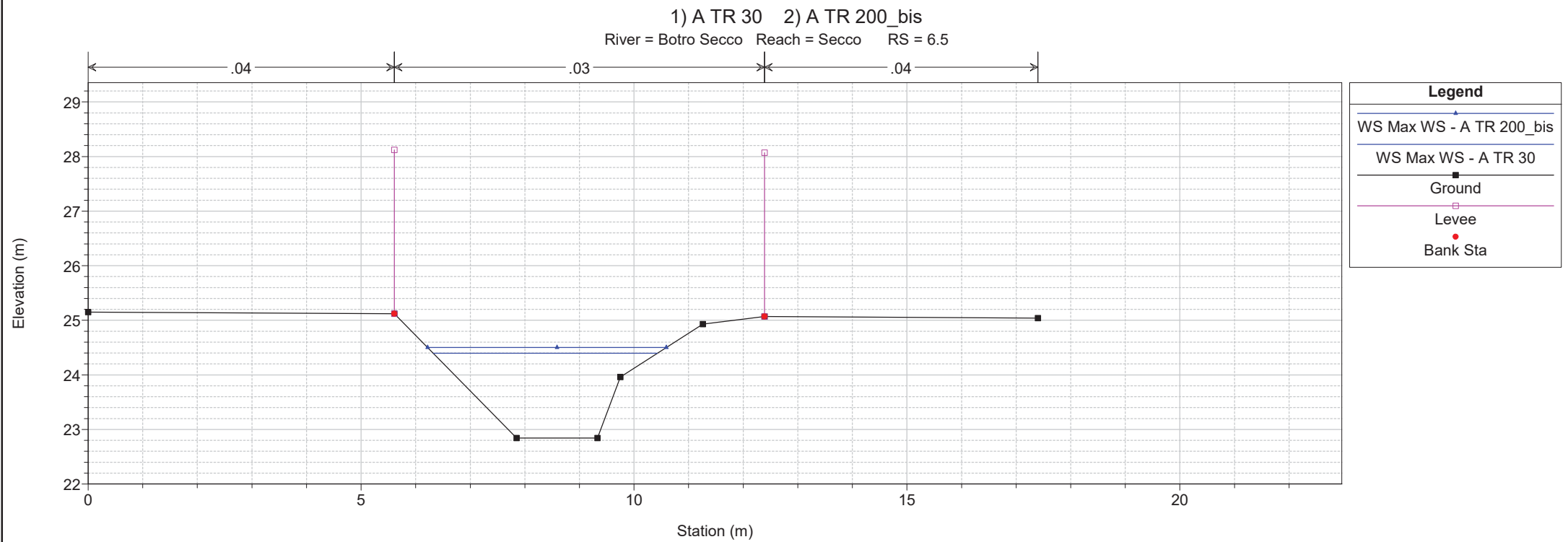
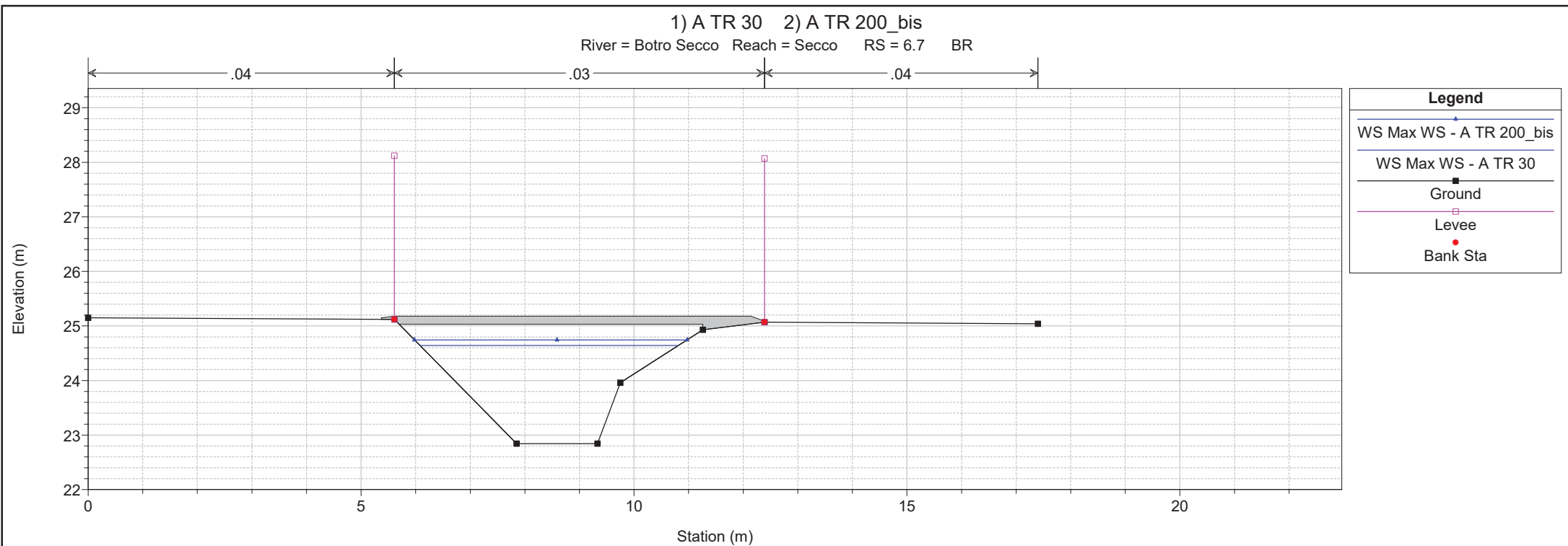

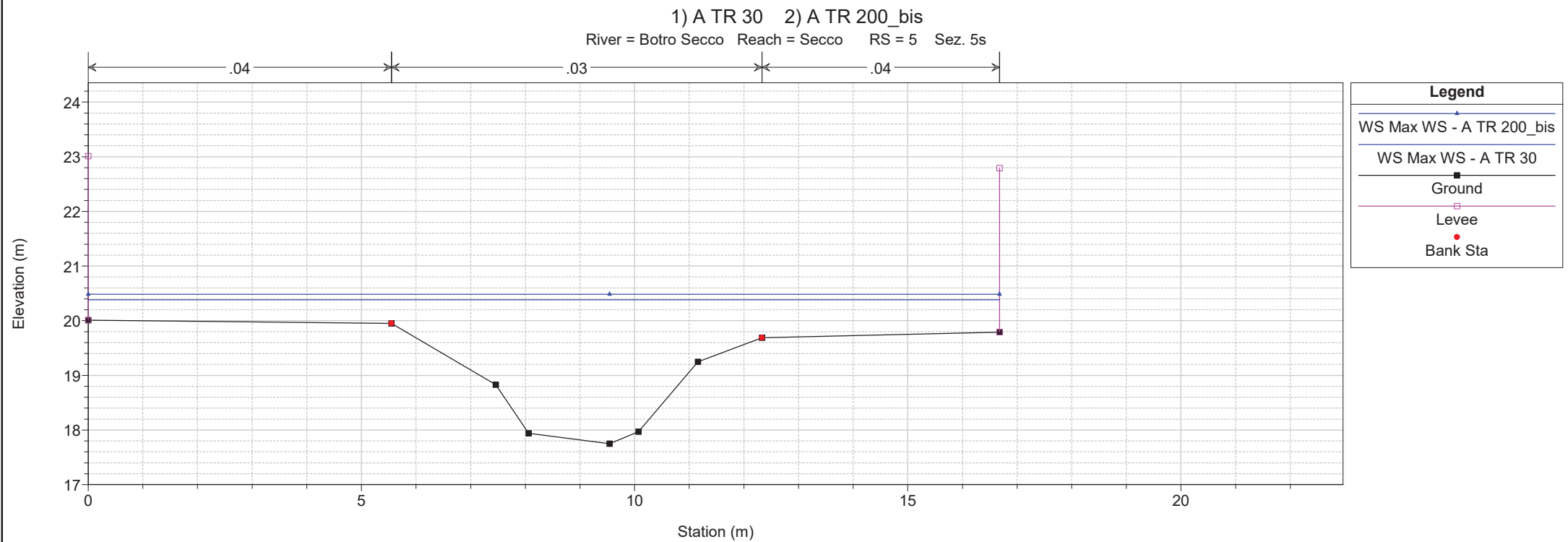
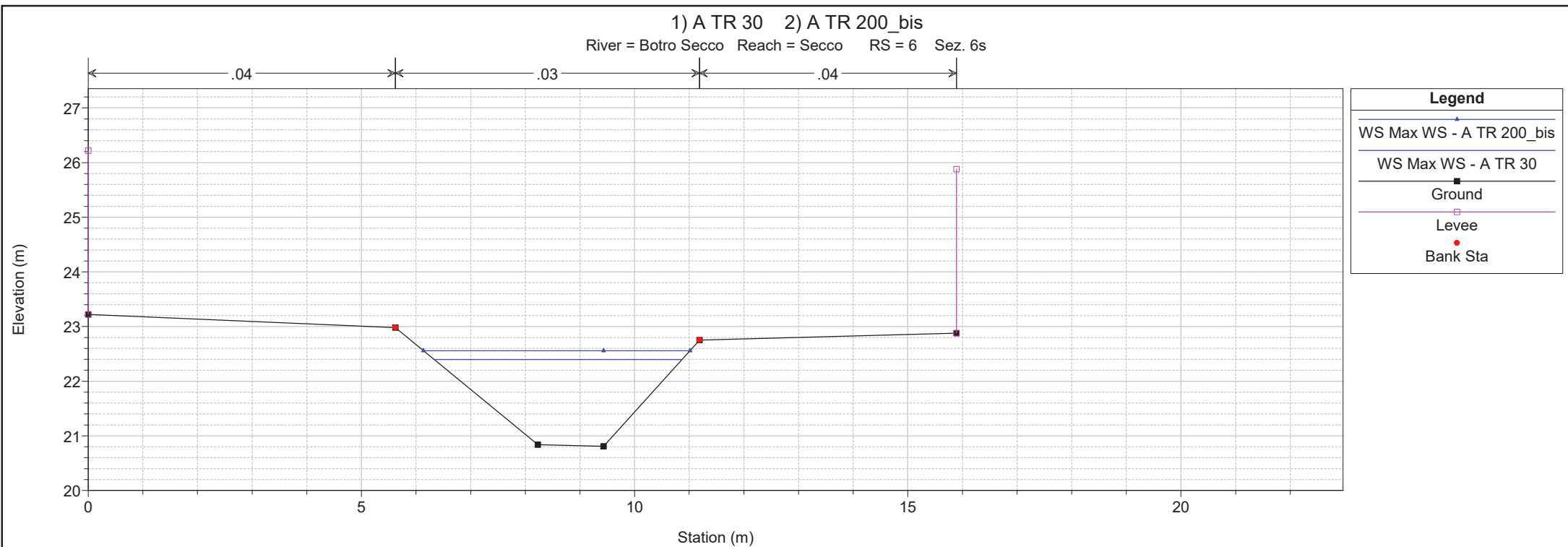

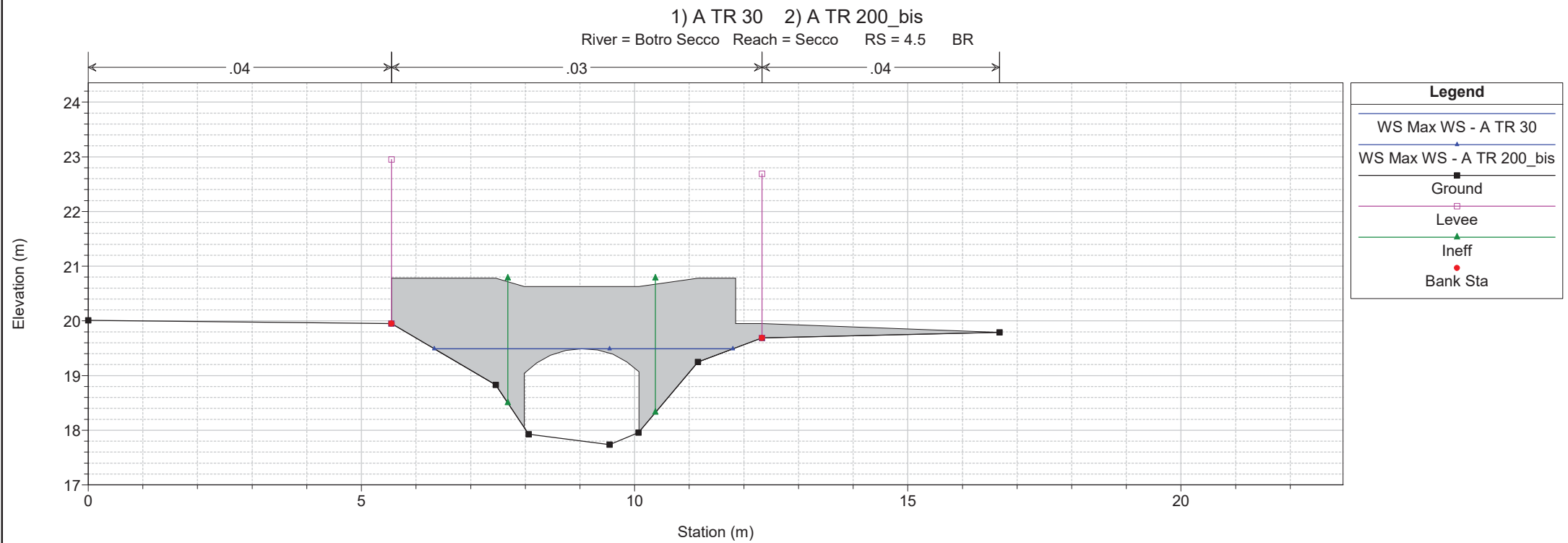
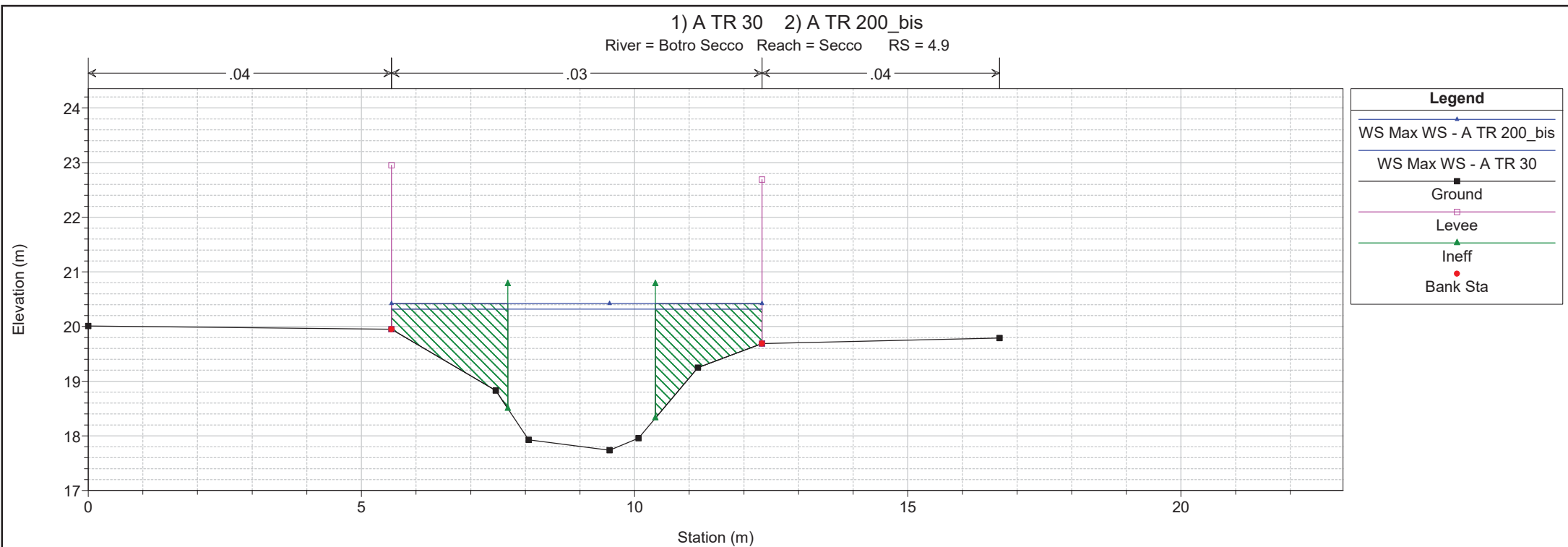

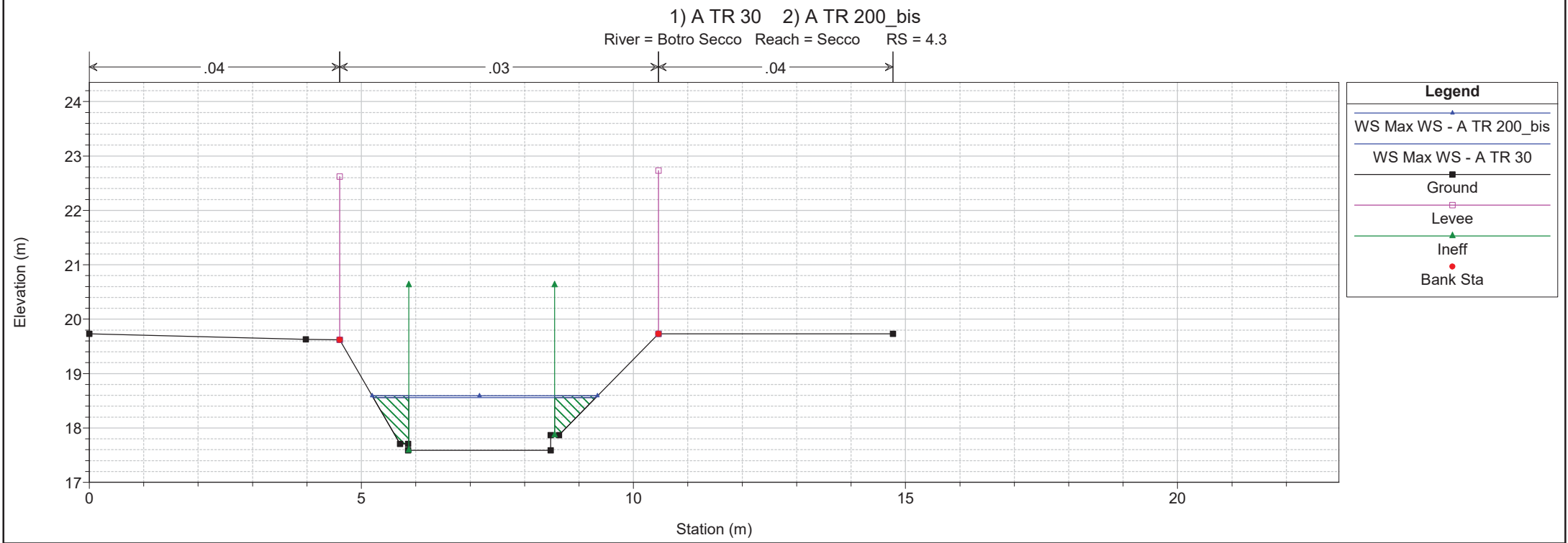
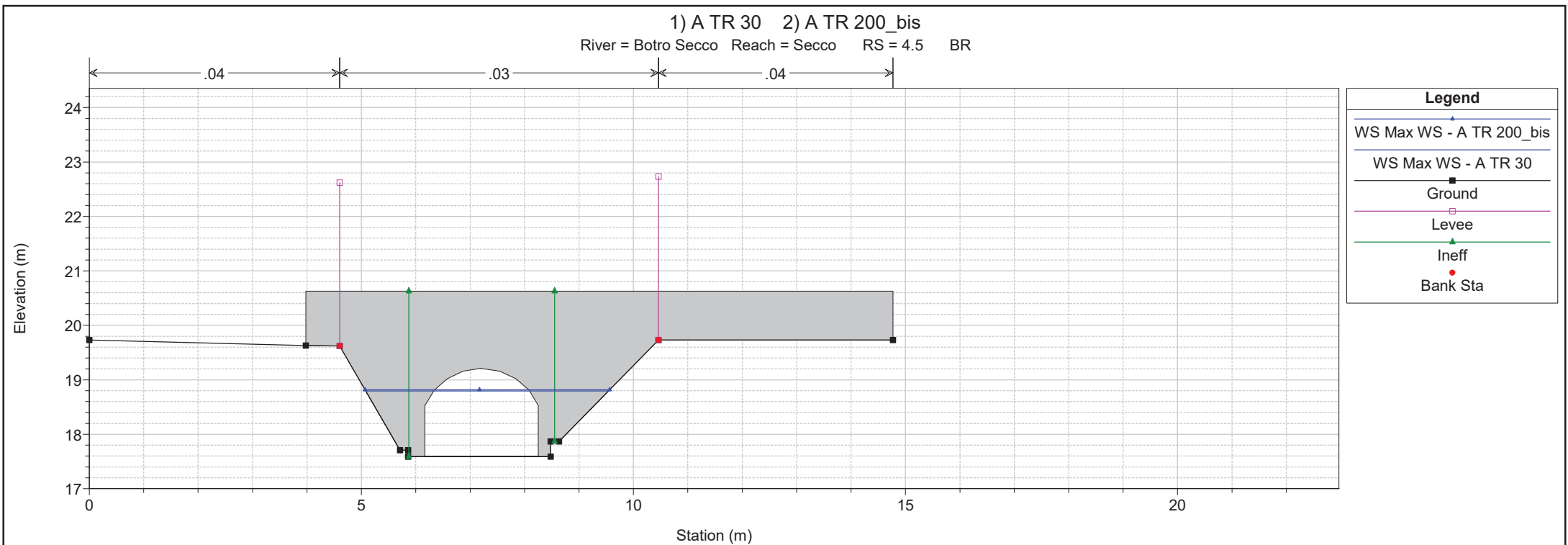

1 cm Horiz. = 1 m 1 cm Vert. = 1 m

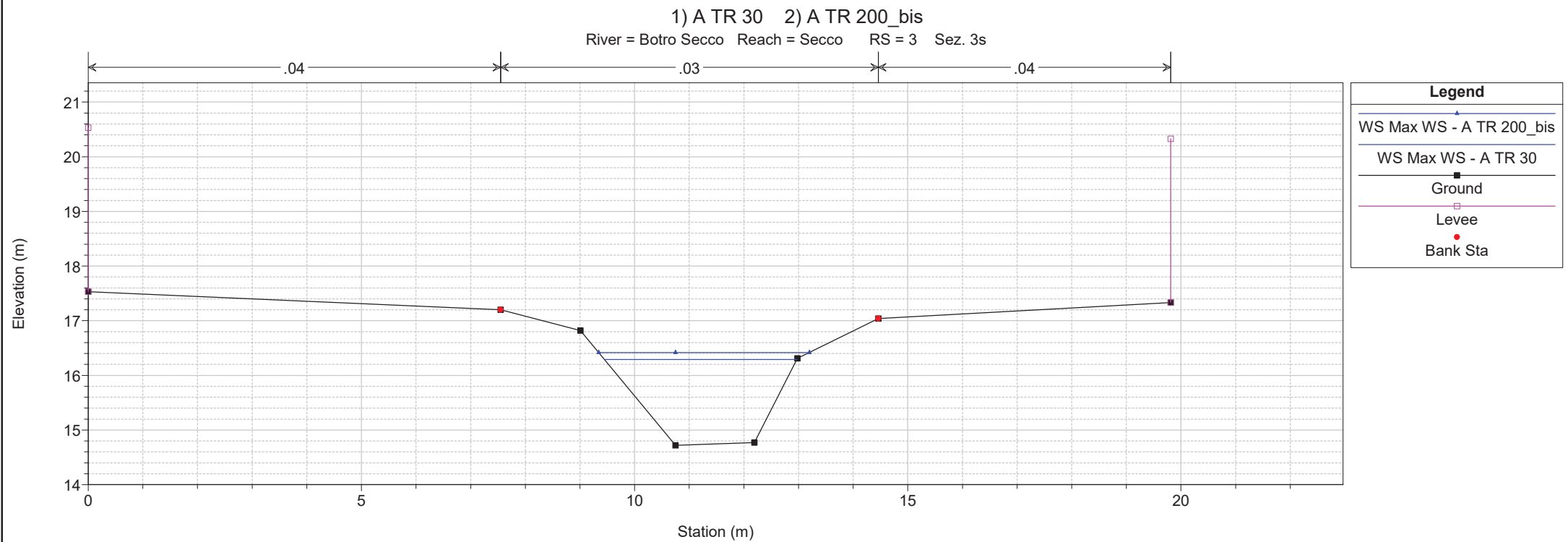
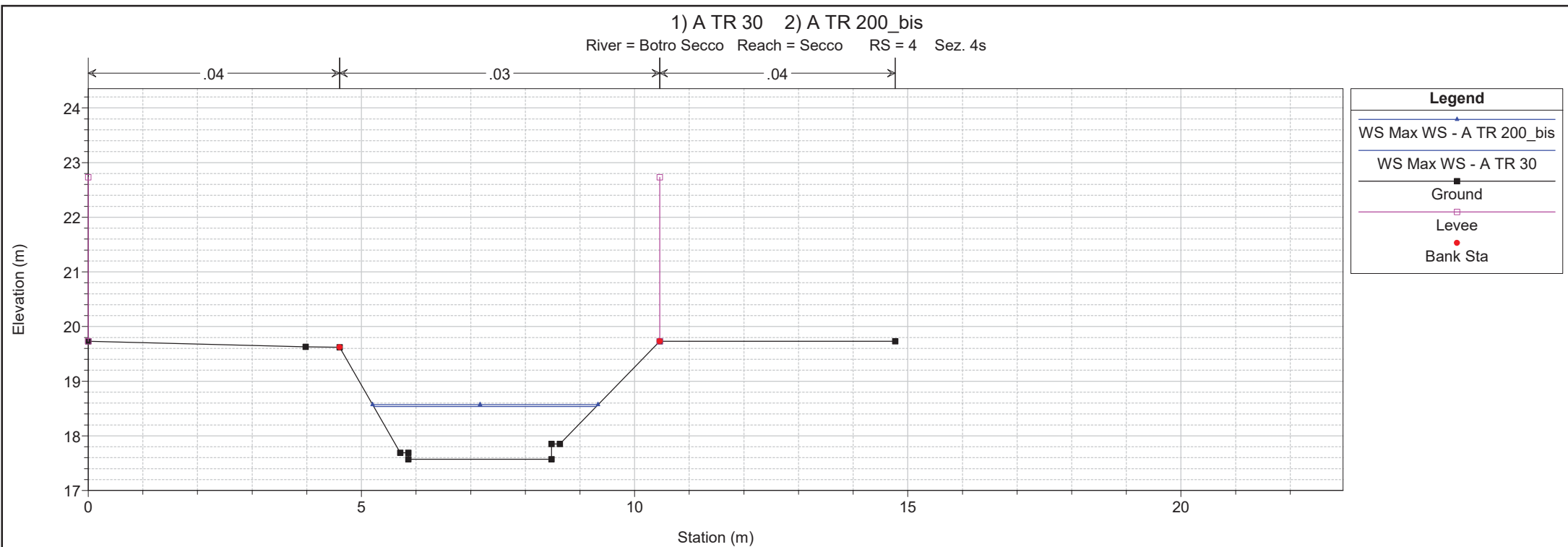

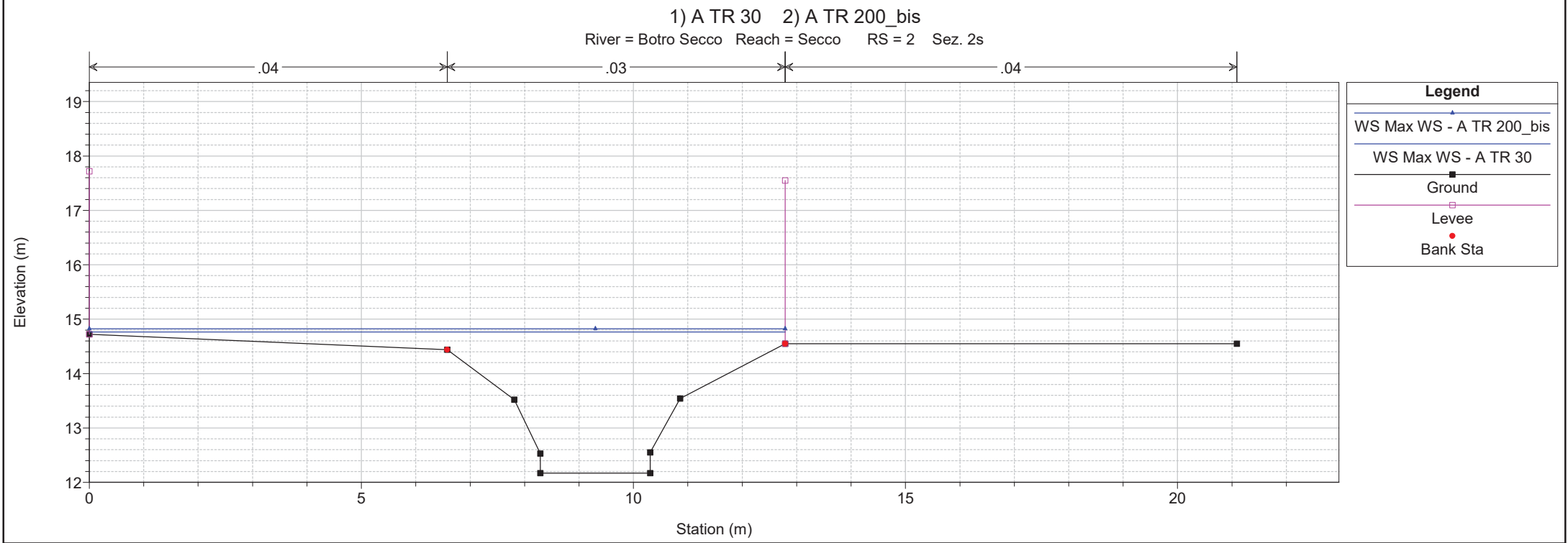
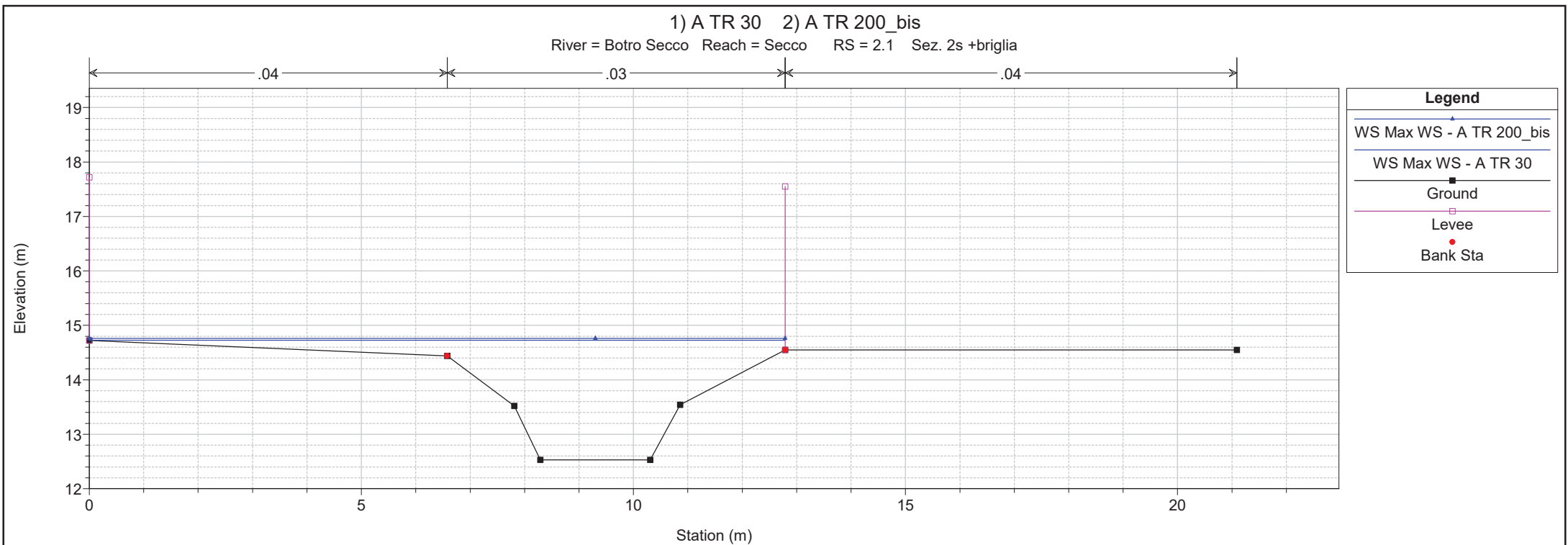

1 cm Horiz. = 1 m 1 cm Vert. = 1 m

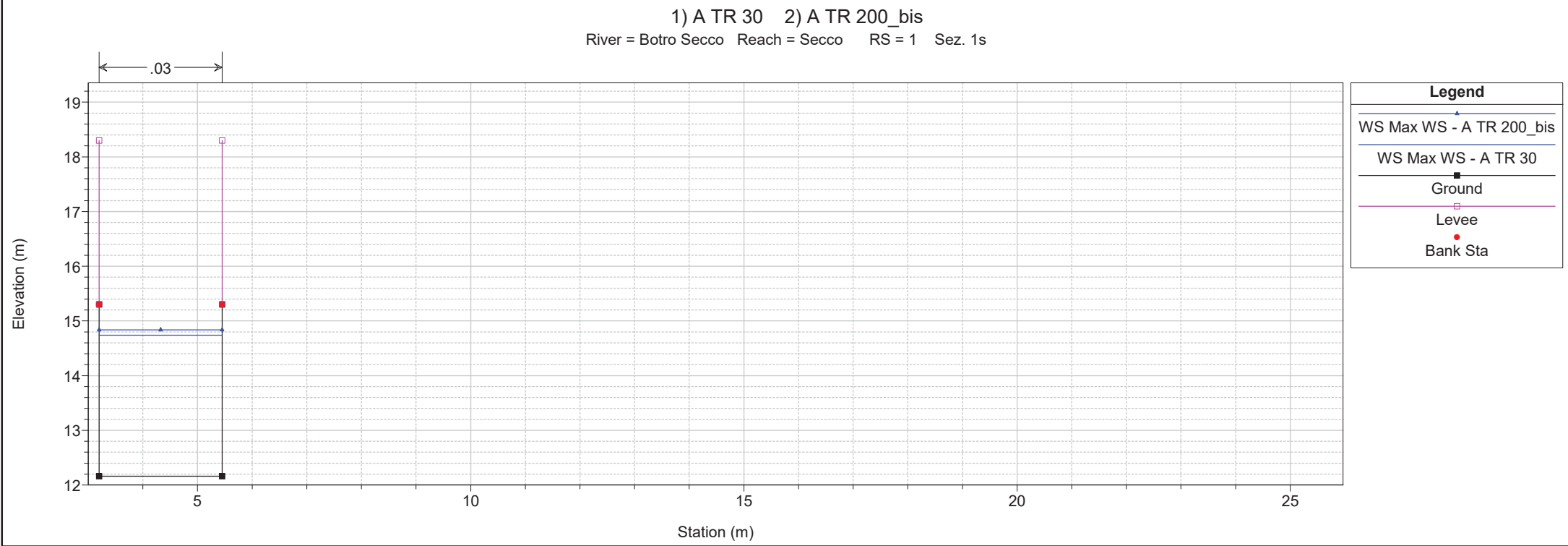
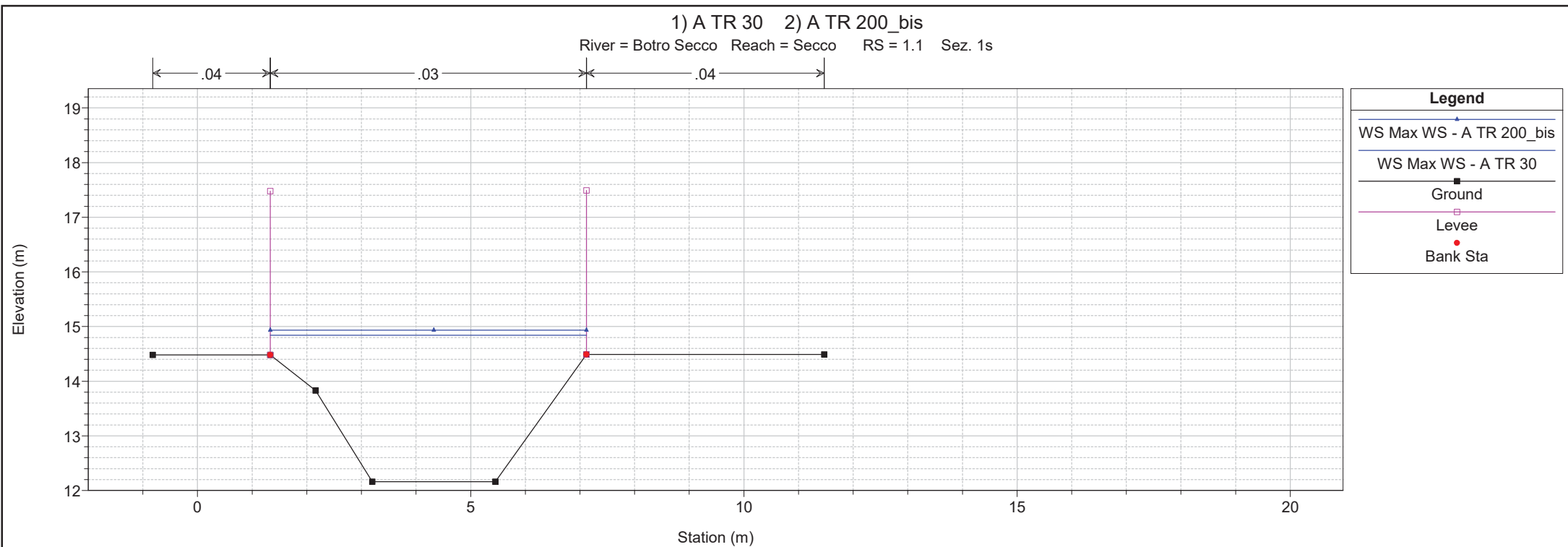

1 cm Horiz. = 1 m 1 cm Vert. = 1 m

1) A TR 30 2) A TR 200_bis
 River = Botro Secco Reach = Secco RS = 0.99 BR

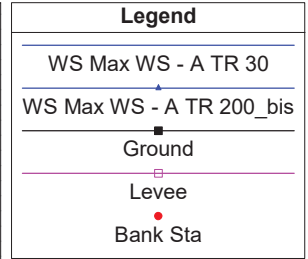
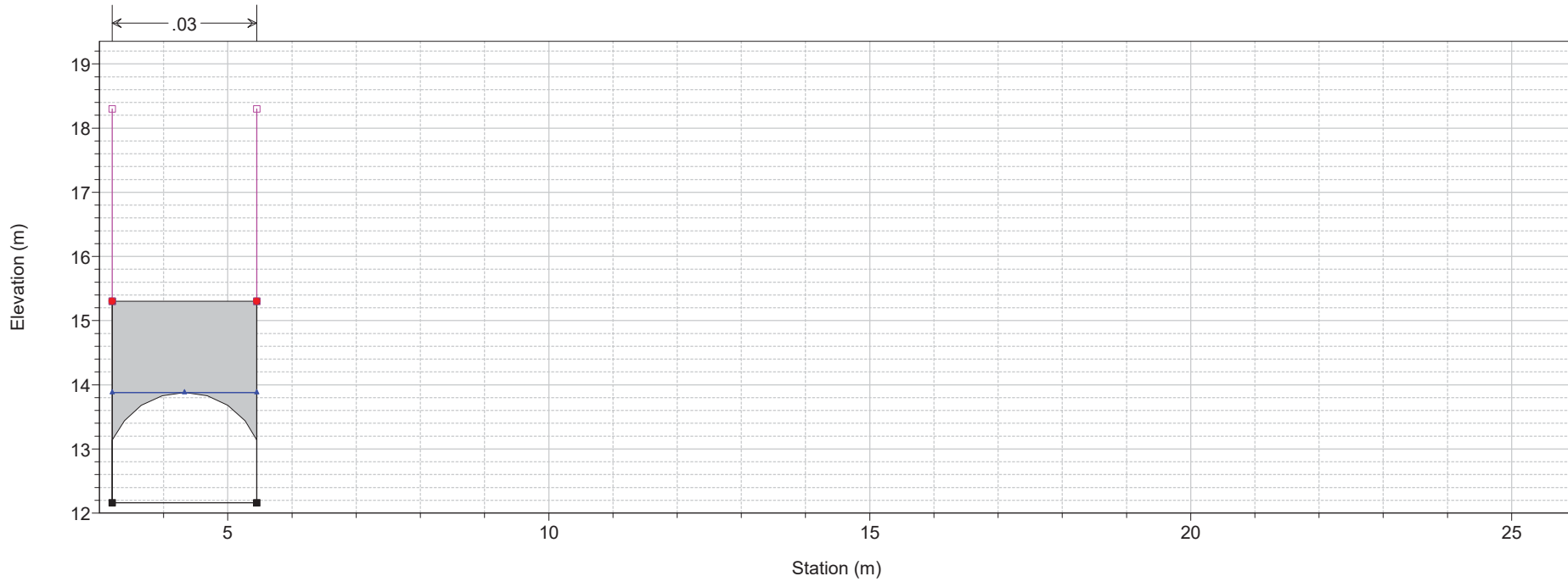

1) A TR 30 2) A TR 200_bis
 River = Botro Secco Reach = Secco RS = 0.99 BR

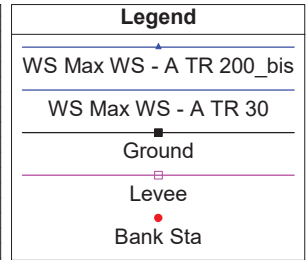
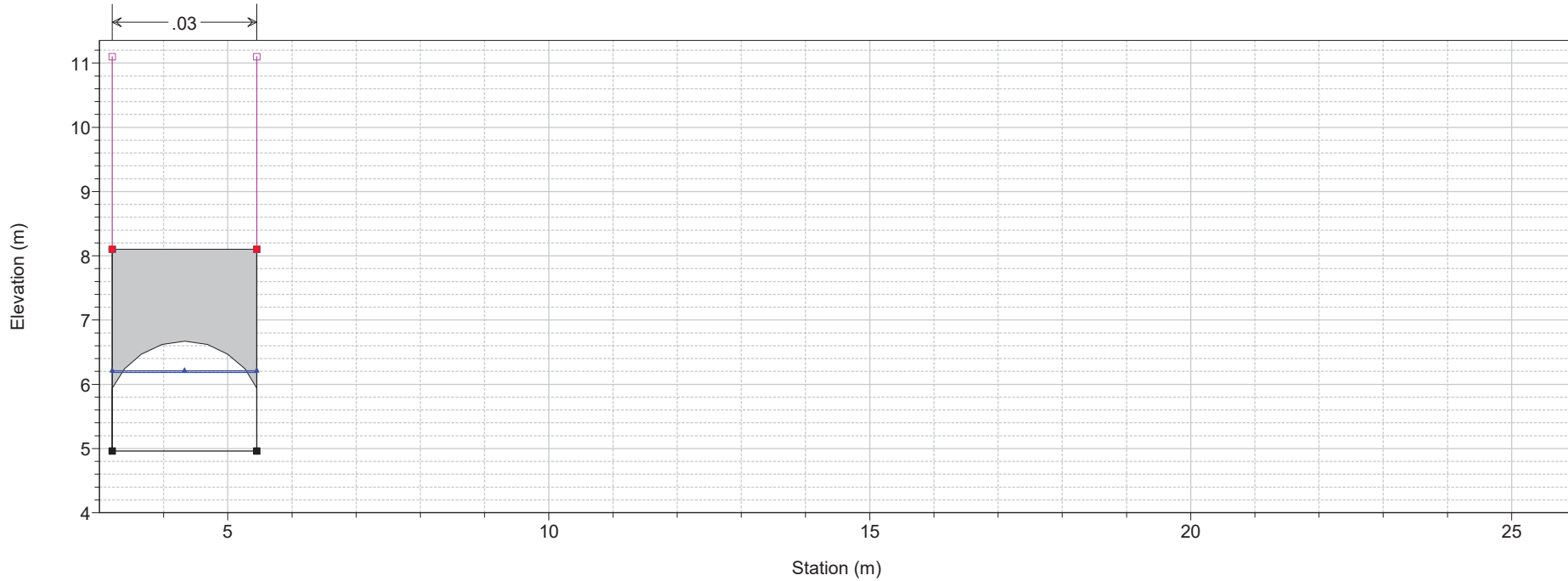

1) A TR 30 2) A TR 200_bis
River = Botro Secco Reach = Secco RS = 0.95

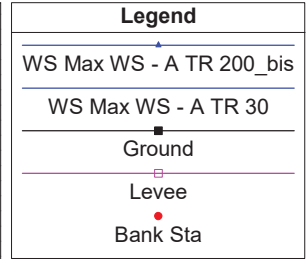
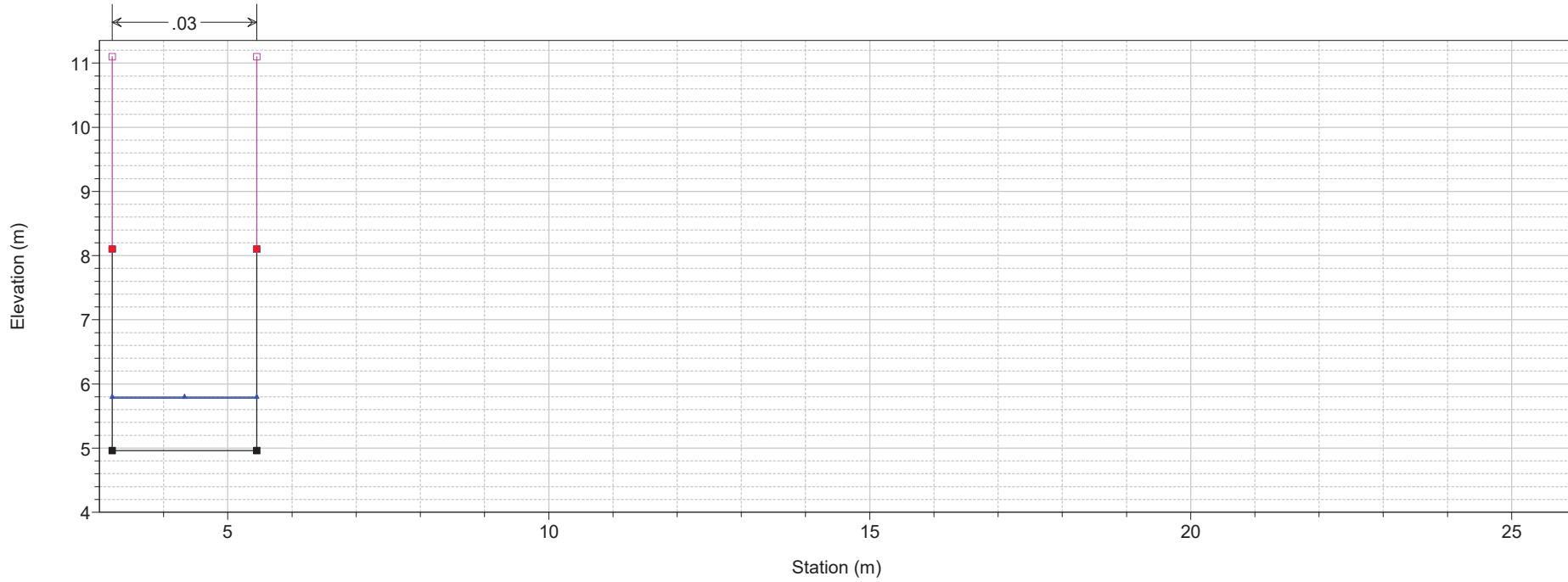

1) A TR 30 2) A TR 200_bis
River = Botro Secco Reach = Secco RS = 0.9

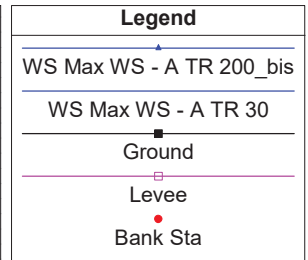
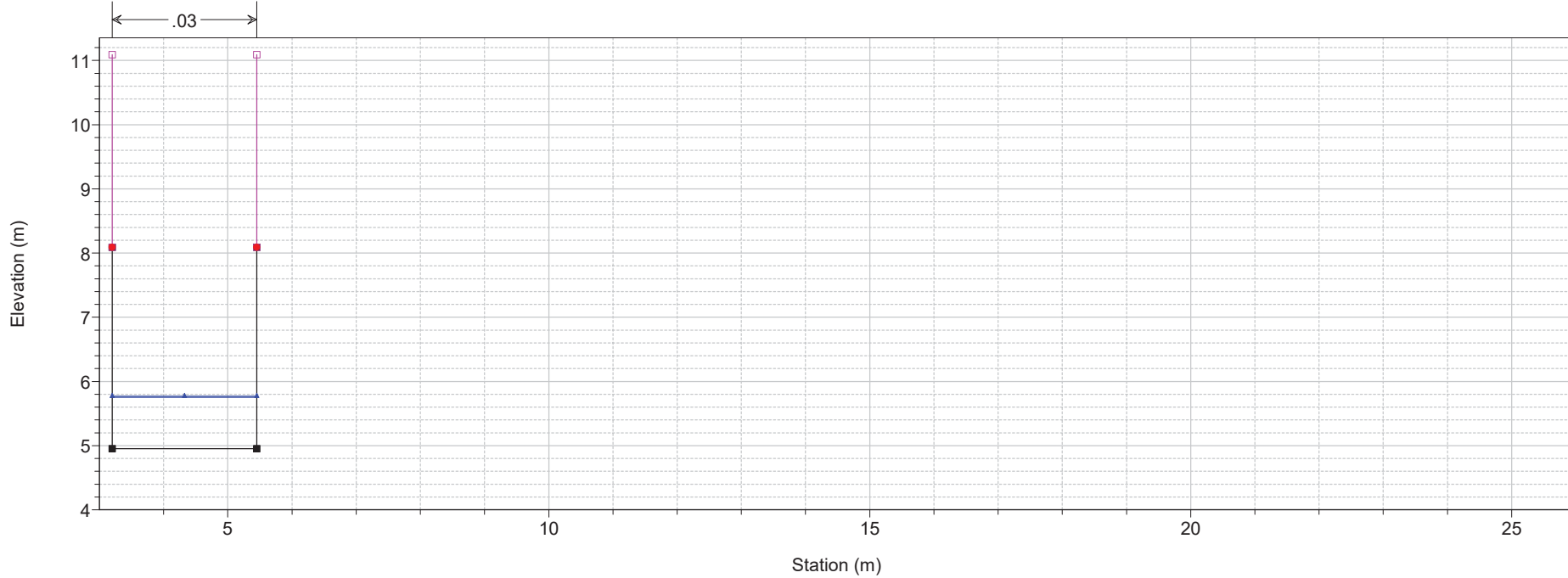

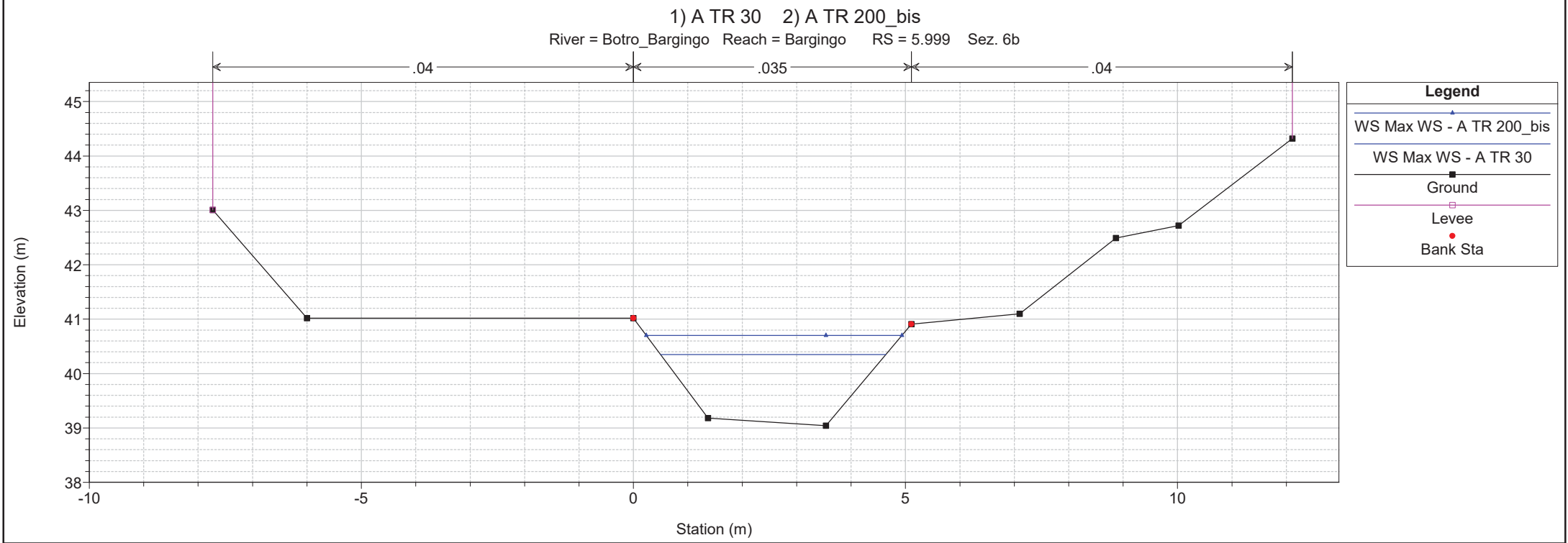
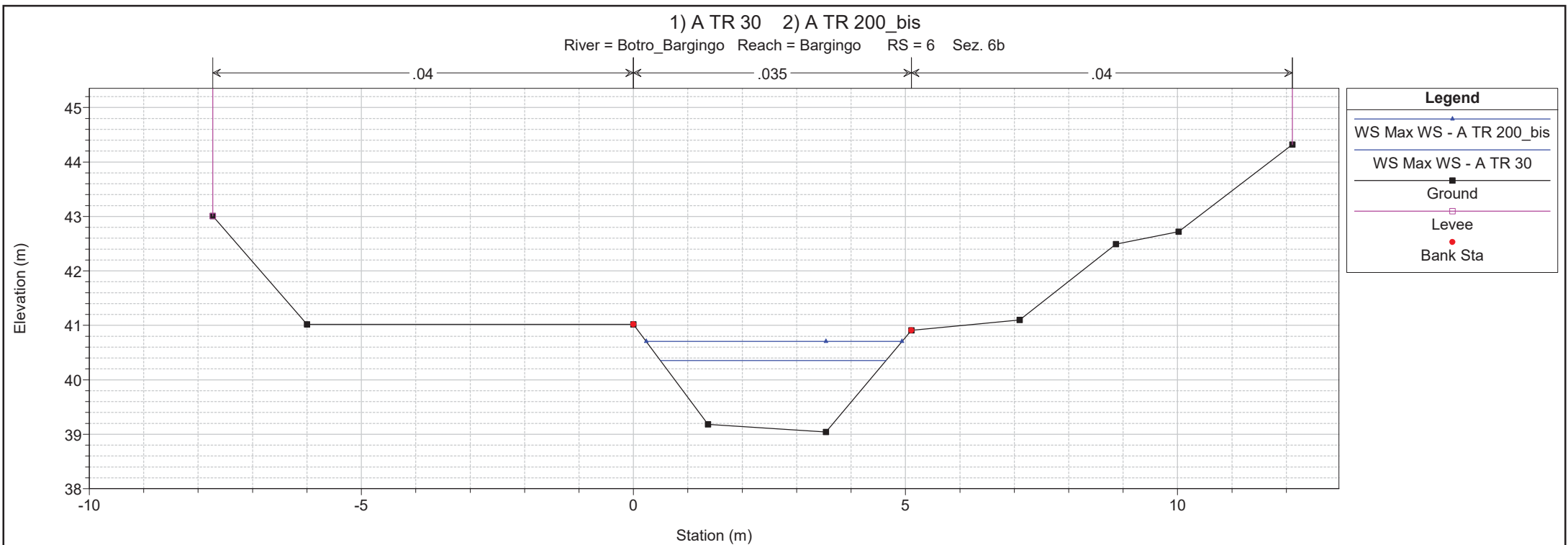

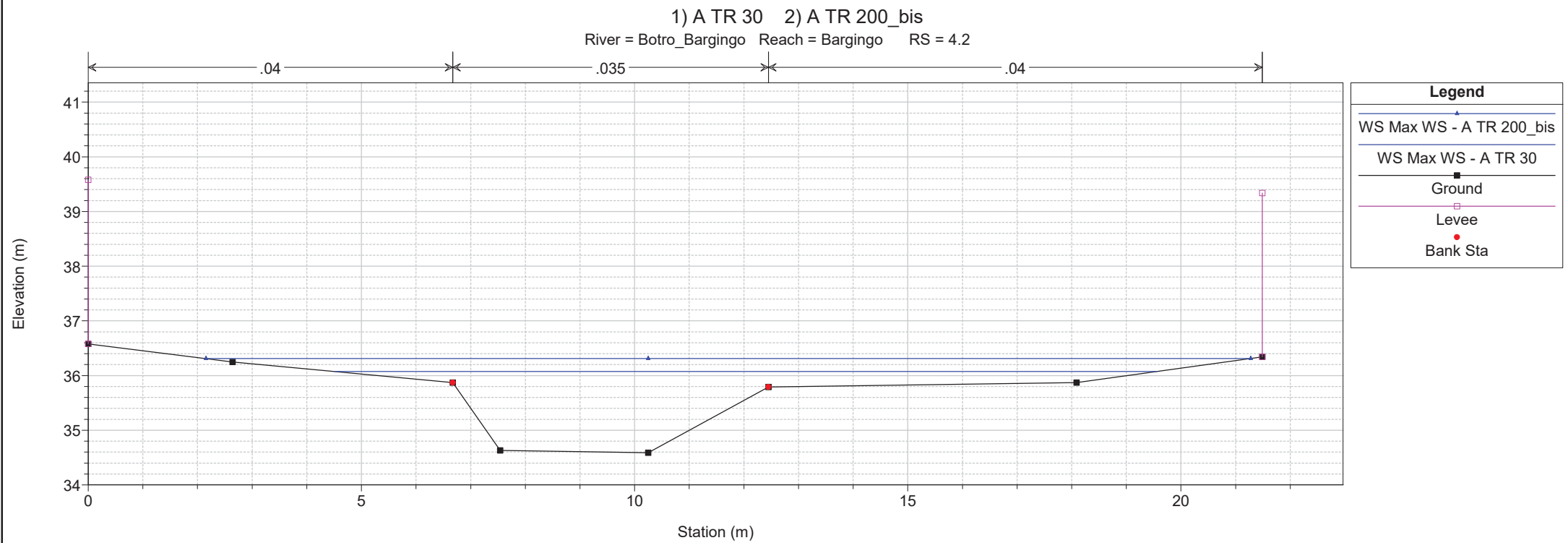
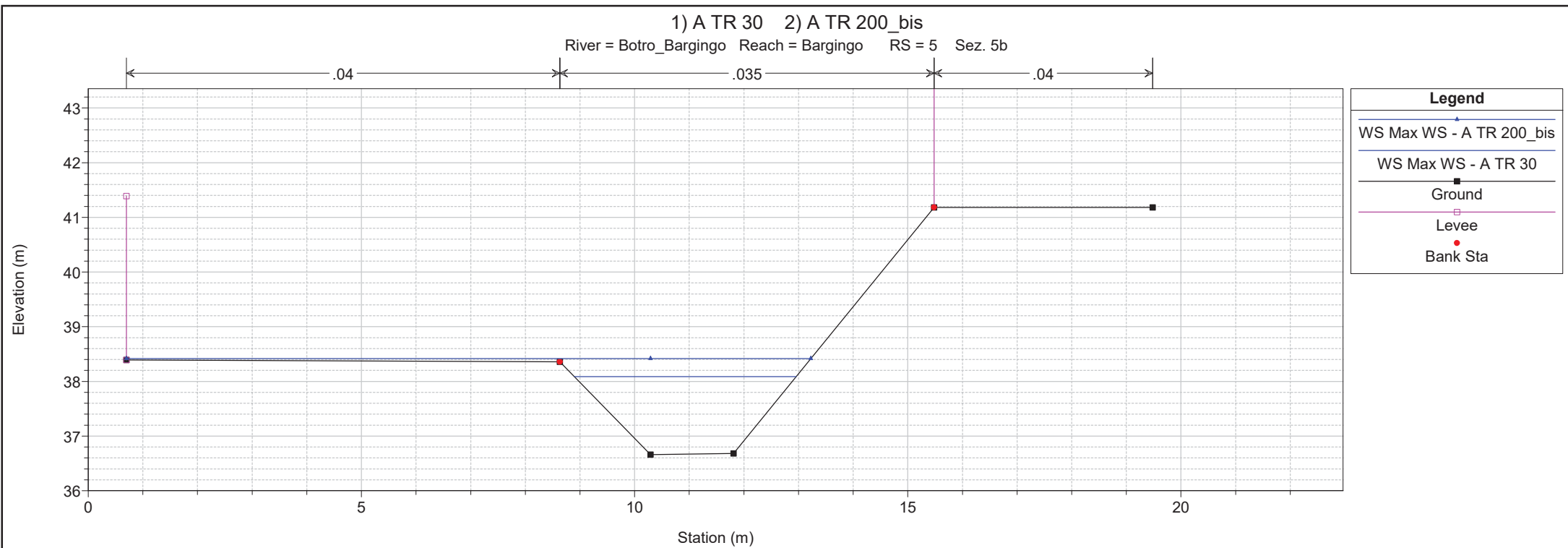

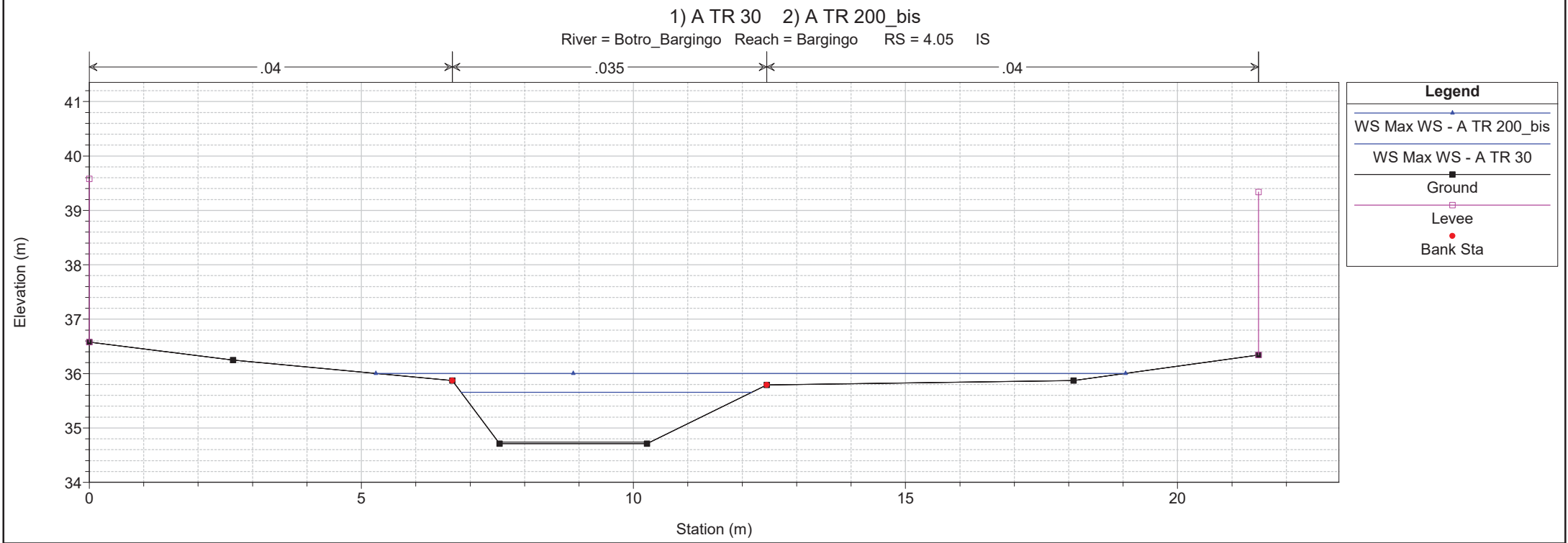
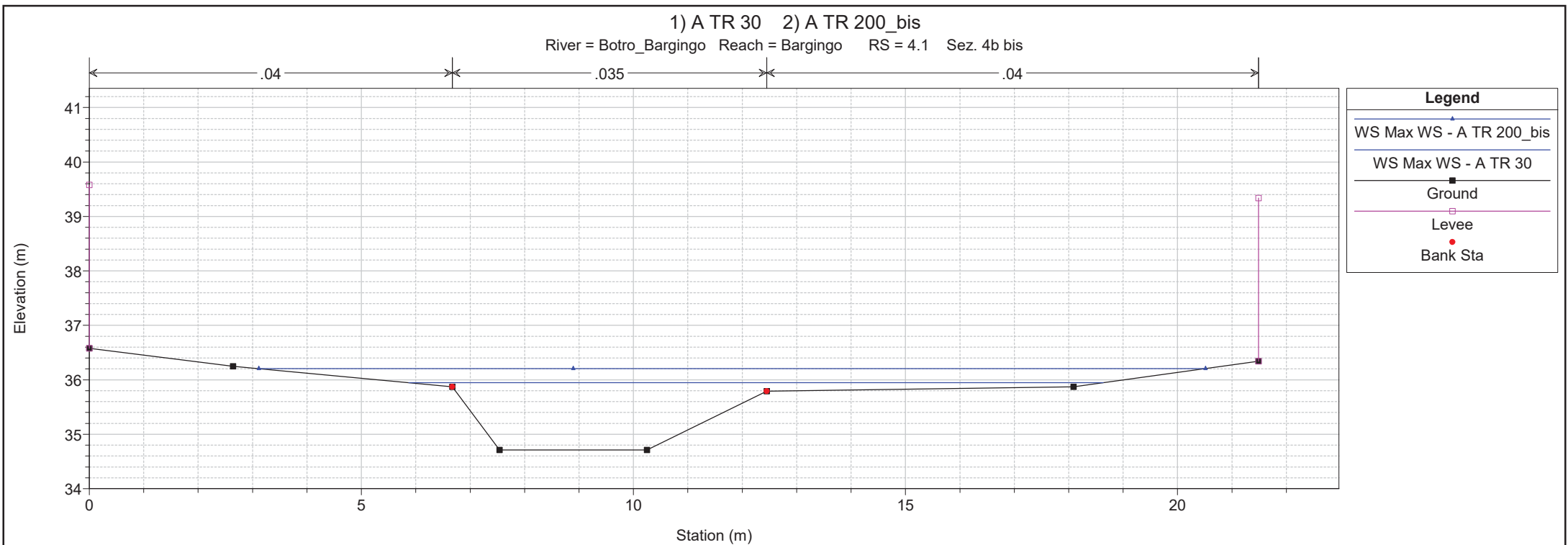

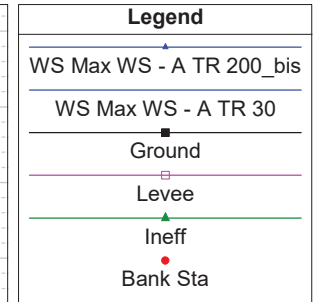
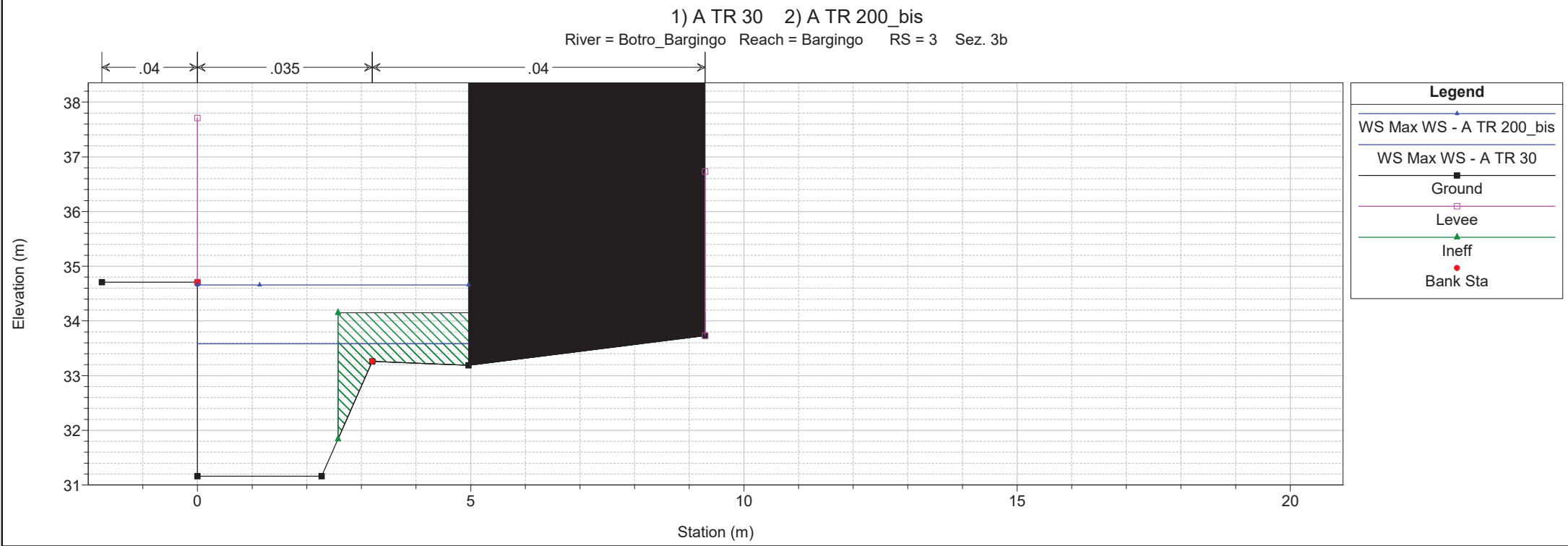
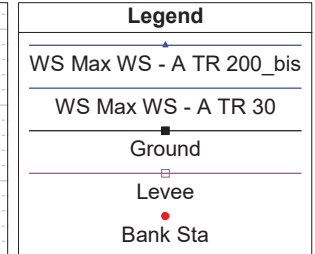
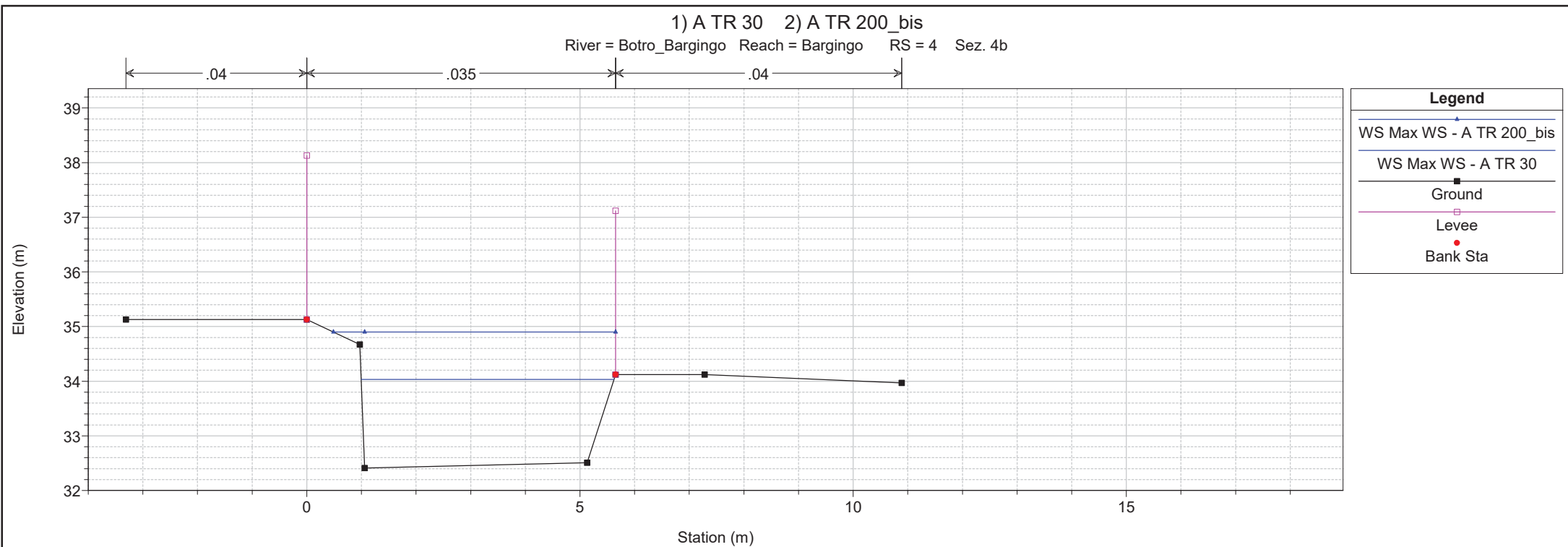

1 cm Horiz. = 1 m 1 cm Vert. = 1 m

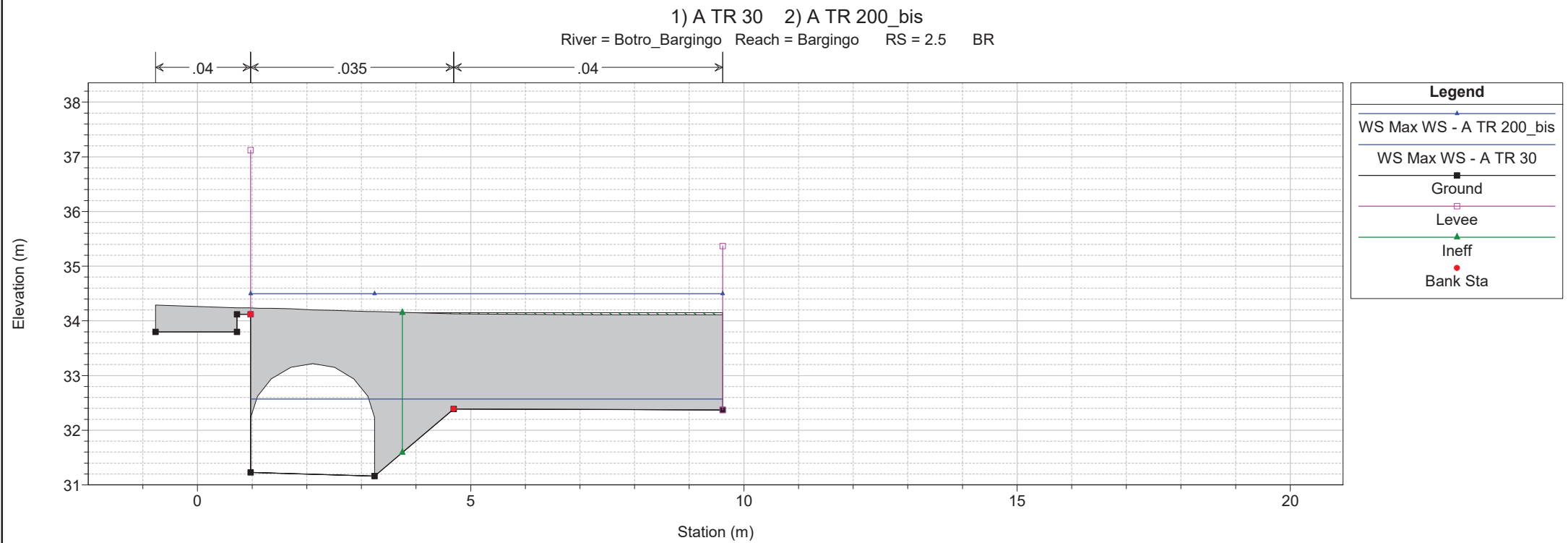
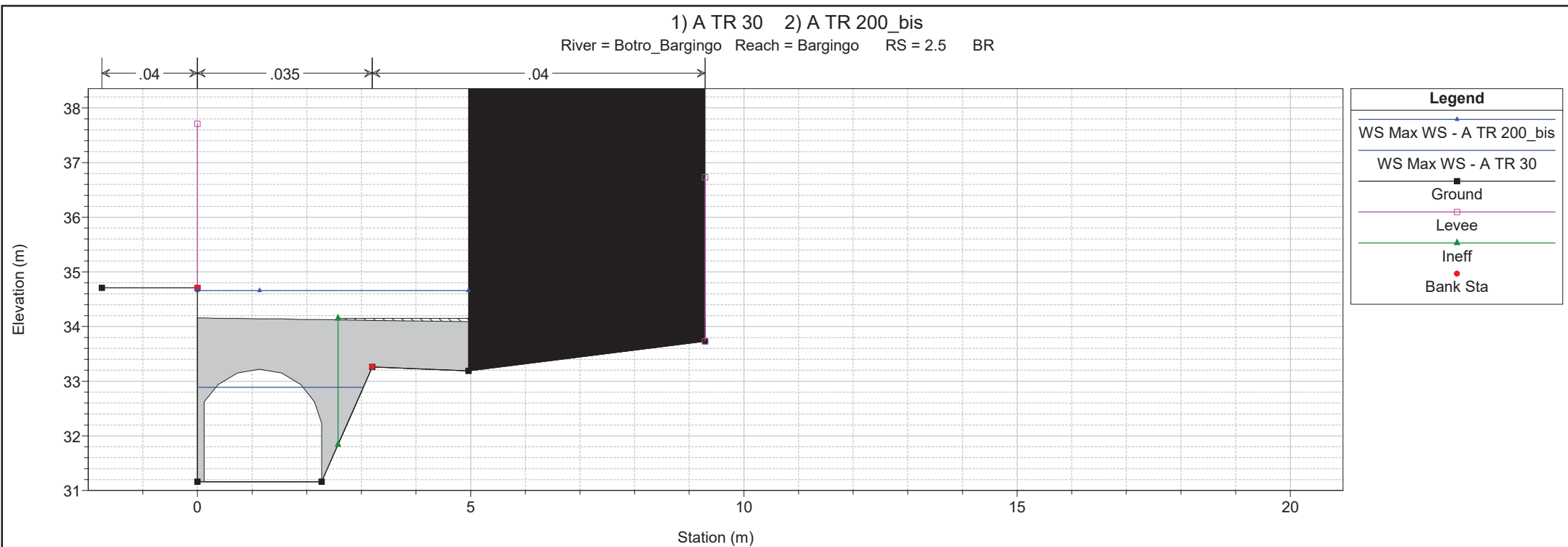

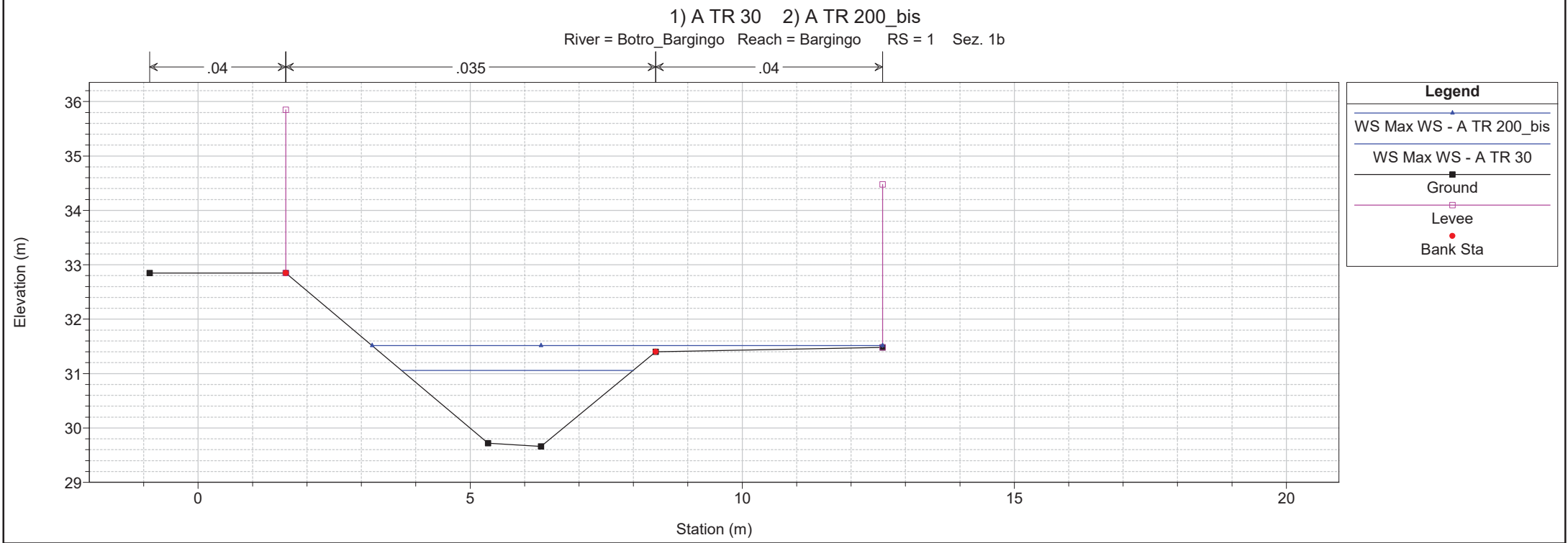
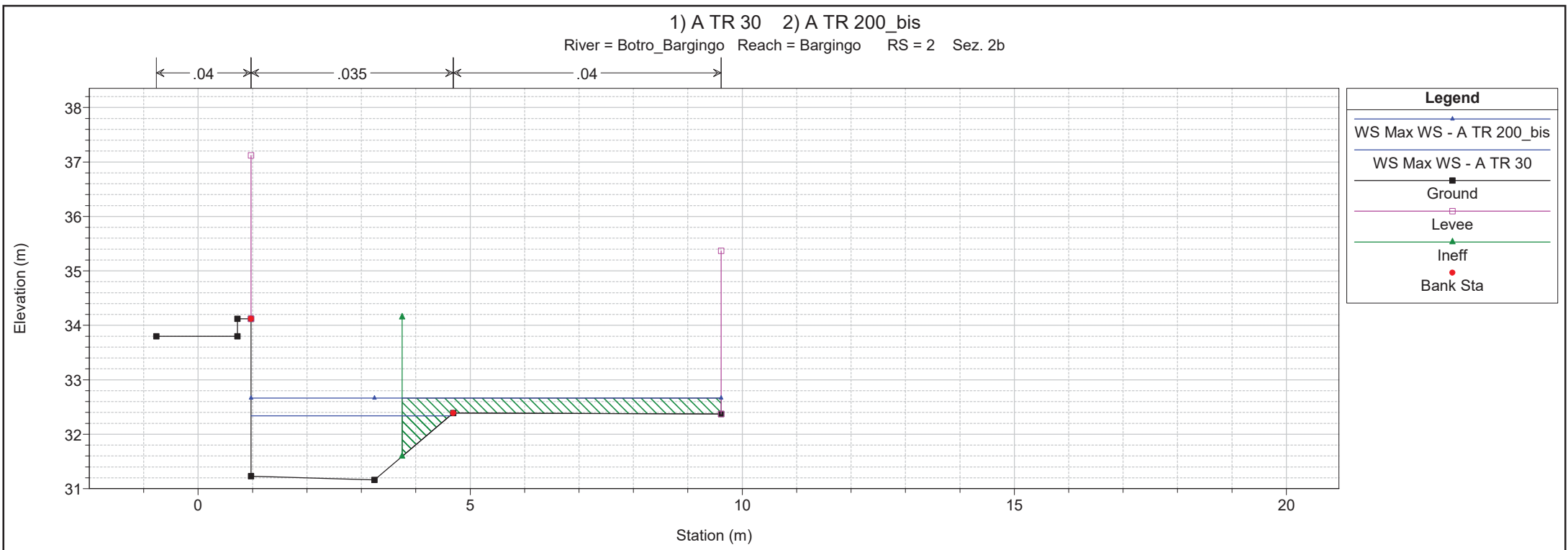

1 cm Horiz. = 1 m 1 cm Vert. = 1 m

1) A TR 30 2) A TR 200_bis
 River = Botro_Bargino Reach = Bargingo RS = 0.9

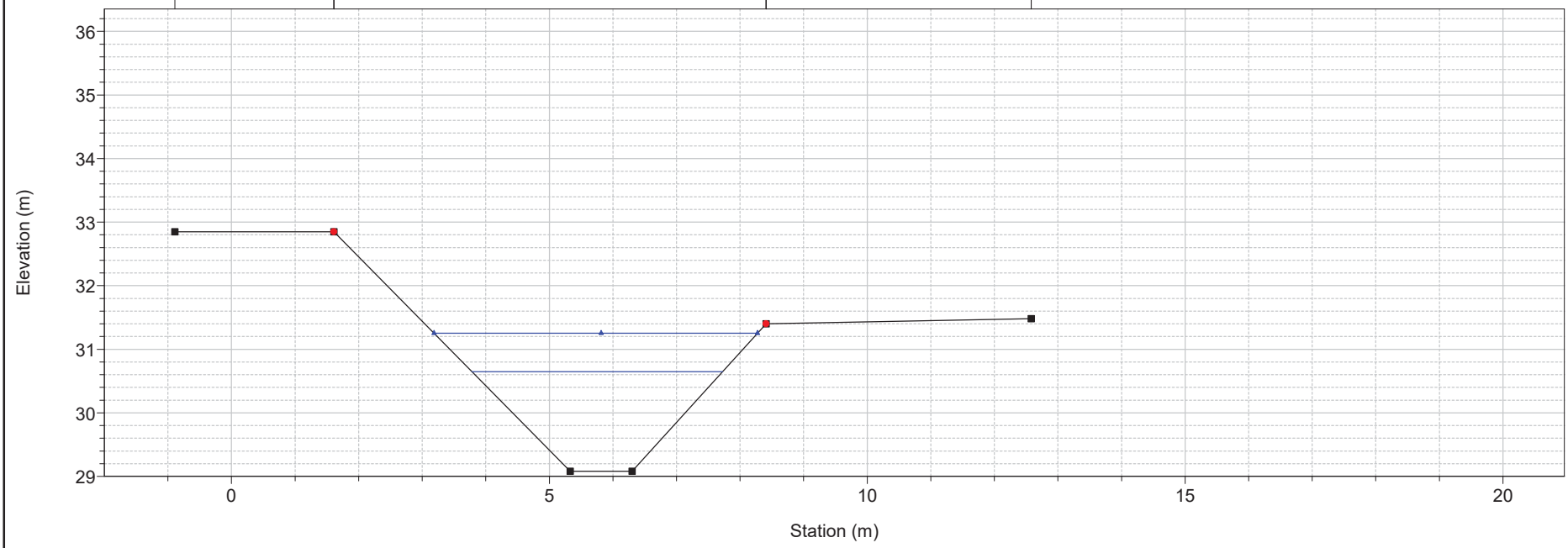

Legend

- WS Max WS - A TR 200_bis
- WS Max WS - A TR 30
- Ground
- Bank Sta

River	Reach	River Sta	Plan	Q Total (m3/s)	Min Ch El (m)	W.S. Elev (m)	Crit W.S. (m)	E.G. Elev (m)	E.G. Slope (m/m)	Vel Chnl (m/s)	Flow Area (m2)	Top Width (m)	Froude # Chl
Botro_Cotone	Cotone	29	A TR 30	9.93	39.78	40.80	40.97	41.46	0.031677	3.60	2.76	3.71	1.33
Botro_Cotone	Cotone	29	A TR 200_bis	15.31	39.78	41.06	41.37	41.89	0.031391	4.04	3.81	5.85	1.35
Botro_Cotone	Cotone	28	A TR 30	9.93	35.46	36.55	36.65	37.12	0.025253	3.33	2.98	3.55	1.16
Botro_Cotone	Cotone	28	A TR 200_bis	15.30	35.46	36.84	36.98	37.56	0.025466	3.75	4.08	3.95	1.18
Botro_Cotone	Cotone	27	A TR 30	9.93	32.59	33.73	33.88	34.36	0.028742	3.51	2.83	3.58	1.26
Botro_Cotone	Cotone	27	A TR 200_bis	15.30	32.59	34.00	34.20	34.79	0.028764	3.93	3.89	4.08	1.28
Botro_Cotone	Cotone	26	A TR 30	9.92	30.04	31.03	31.30	31.89	0.044451	4.11	2.42	3.51	1.58
Botro_Cotone	Cotone	26	A TR 200_bis	15.29	30.04	31.43	31.62	32.18	0.027339	3.83	3.99	4.36	1.28
Botro_Cotone	Cotone	25.5	A TR 30	9.91	29.08	30.65	30.41	30.95	0.010310	2.42	4.09	3.77	0.74
Botro_Cotone	Cotone	25.5	A TR 200_bis	15.29	29.08	31.25	30.76	31.52	0.006763	2.30	6.64	4.67	0.62
Botro_Cotone	Cotone_valle1	25.9	A TR 30	21.68	29.08	30.65	31.08	32.15	0.007990	5.44	3.99	3.42	1.61
Botro_Cotone	Cotone_valle1	25.9	A TR 200_bis	34.36	29.08	31.25	31.66	32.89	0.006269	5.67	6.06	3.42	1.36
Botro_Cotone	Cotone_valle1	25	A TR 30	21.63	28.98	30.57	31.02	32.11	0.008441	5.51	3.92	3.42	1.64
Botro_Cotone	Cotone_valle1	25	A TR 200_bis	34.36	28.98	31.19	31.59	32.83	0.006344	5.67	6.06	3.42	1.36
Botro_Cotone	Cotone_valle1	24	A TR 30	17.76	27.99	30.53	29.44	30.76	0.000730	2.12	8.38	4.10	0.47
Botro_Cotone	Cotone_valle1	24	A TR 200_bis	26.84	27.99	31.28	29.90	31.56	0.000723	2.35	11.44	4.10	0.45
Botro_Cotone	Cotone_valle1	23.5		Bridge									
Botro_Cotone	Cotone_valle1	23	A TR 30	22.29	25.43	26.53	27.55	30.49	0.013198	8.81	2.53	2.76	2.70
Botro_Cotone	Cotone_valle1	23	A TR 200_bis	34.58	25.43	26.84	28.27	32.59	0.013685	10.62	3.26	2.94	2.87
Botro_Cotone	Cotone_valle1	22.1	A TR 30	22.51	25.03	25.59	26.85	36.32	0.099317	14.52	1.55	2.96	6.41
Botro_Cotone	Cotone_valle1	22.1	A TR 200_bis	34.61	25.03	25.91	27.48	35.41	0.056839	13.66	2.53	3.17	4.88
Botro_Cotone	Cotone_valle1	22	A TR 30	22.53	24.30	25.49	26.32	28.39	0.014747	7.55	2.98	2.90	2.38
Botro_Cotone	Cotone_valle1	22	A TR 200_bis	34.62	24.30	25.83	27.56	29.60	0.015536	8.59	4.03	3.12	2.42
Botro_Cotone	Cotone_valle1	21	A TR 30	22.55	24.30	25.44	26.32	28.67	0.016958	7.96	2.83	2.85	2.54
Botro_Cotone	Cotone_valle1	21	A TR 200_bis	34.63	24.30	25.79	27.57	29.90	0.017491	8.98	3.86	3.07	2.56
Botro_Cotone	Cotone_valle1	20	A TR 30	22.90	23.51	24.62	25.52	27.91	0.017303	8.04	2.85	2.92	2.60
Botro_Cotone	Cotone_valle1	20	A TR 200_bis	34.79	23.51	24.93	26.70	29.27	0.018739	9.23	3.77	3.12	2.68
Botro_Cotone	Cotone_valle1	19	A TR 30	22.92	23.49	24.58	25.50	28.06	0.018703	8.27	2.77	2.90	2.70
Botro_Cotone	Cotone_valle1	19	A TR 200_bis	34.80	23.49	24.88	26.68	29.45	0.020090	9.47	3.67	3.10	2.78
Botro_Cotone	Cotone_valle1	18	A TR 30	23.23	22.83	23.56	24.75	31.26	0.057870	12.30	1.89	2.96	4.91
Botro_Cotone	Cotone_valle1	18	A TR 200_bis	34.94	22.83	23.80	25.79	32.81	0.051430	13.30	2.63	3.14	4.64
Botro_Cotone	Cotone_valle1	17	A TR 30	23.25	22.79	23.37	24.66	34.50	0.099794	14.78	1.57	2.93	6.43
Botro_Cotone	Cotone_valle1	17	A TR 200_bis	34.94	22.79	23.65	25.72	34.15	0.064240	14.36	2.43	3.13	5.20
Botro_Cotone	Cotone_valle1	16.99	A TR 30	23.25	22.79	23.36	24.66	34.93	0.105645	15.07	1.54	2.92	6.62
Botro_Cotone	Cotone_valle1	16.99	A TR 200_bis	34.94	22.79	23.65	25.33	34.32	0.065759	14.47	2.41	3.13	5.26
Botro_Cotone	Cotone_valle1	16.9	A TR 30	23.25	22.26	23.33	24.31	27.22	0.021381	8.74	2.66	2.89	2.91
Botro_Cotone	Cotone_valle1	16.9	A TR 200_bis	34.95	22.26	23.63	24.86	28.59	0.022252	9.87	3.54	3.11	2.95
Botro_Cotone	Cotone_valle1	16	A TR 30	23.52	21.70	22.66	23.50	25.83	0.017432	7.89	2.98	3.25	2.63
Botro_Cotone	Cotone_valle1	16	A TR 200_bis	35.06	21.70	22.90	24.69	27.30	0.020029	9.29	3.77	3.31	2.78
Botro_Cotone	Cotone_valle1	15.1	A TR 30	23.63	21.66	22.16	23.47	34.55	0.125872	15.59	1.52	3.10	7.12
Botro_Cotone	Cotone_valle1	15.1	A TR 200_bis	35.10	21.66	22.43	24.65	33.61	0.074438	14.81	2.37	3.18	5.48
Botro_Cotone	Cotone_valle1	15	A TR 30	23.63	21.66	22.07	23.47	40.49	0.229200	19.01	1.24	3.07	9.54
Botro_Cotone	Cotone_valle1	15	A TR 200_bis	35.11	21.66	22.39	24.23	34.88	0.087400	15.66	2.24	3.17	5.94
Botro_Cotone	Cotone_valle1	14.7	A TR 30	23.64	20.82	22.01	22.74	24.46	0.011776	6.93	3.41	3.05	2.09
Botro_Cotone	Cotone_valle1	14.7	A TR 200_bis	35.11	20.82	22.36	23.29	25.48	0.012394	7.83	4.49	3.16	2.10
Botro_Cotone	Cotone_valle1	14	A TR 30	24.34	19.92	21.06	21.73	23.30	0.010321	6.63	3.67	3.50	2.07
Botro_Cotone	Cotone_valle1	14	A TR 200_bis	35.37	19.92	21.37	22.43	24.15	0.010481	7.39	4.79	3.65	2.06
Botro_Cotone	Cotone_valle1	13	A TR 30	25.35	18.61	19.48	20.49	23.97	0.026831	9.39	2.70	3.25	3.29
Botro_Cotone	Cotone_valle1	13	A TR 200_bis	36.06	18.61	19.70	21.68	25.32	0.027503	10.50	3.43	3.32	3.30
Botro_Cotone	Cotone_valle1	12	A TR 30	25.44	18.40	19.02	20.29	28.15	0.075089	13.39	1.90	3.17	5.52
Botro_Cotone	Cotone_valle1	12	A TR 200_bis	36.14	18.40	19.29	20.76	28.00	0.051049	13.08	2.76	3.26	4.53
Botro_Cotone	Cotone_valle1	11.9	A TR 30	25.45	18.39	18.98	20.28	29.14	0.087814	14.12	1.80	3.16	5.97
Botro_Cotone	Cotone_valle1	11.9	A TR 200_bis	36.14	18.39	19.26	20.75	28.32	0.054023	13.34	2.71	3.25	4.66
Botro_Cotone	Cotone_valle1	11.7	A TR 30	25.46	17.86	18.94	19.76	21.86	0.014576	7.57	3.36	3.26	2.38
Botro_Cotone	Cotone_valle1	11.7	A TR 200_bis	36.15	17.86	19.23	20.24	22.79	0.014681	8.36	4.33	3.33	2.34
Botro_Cotone	Cotone_valle1	11.68		Lat Struct									
Botro_Cotone	Cotone_valle1	11	A TR 30	26.47	16.09	17.36	17.99	19.40	0.008531	6.33	4.18	3.64	1.88
Botro_Cotone	Cotone_valle1	11	A TR 200_bis	36.94	16.09	17.66	18.61	20.14	0.008684	6.97	5.30	3.79	1.88
Botro_Cotone	Cotone_valle1	10.998		Lat Struct									
Botro_Cotone	Cotone_valle1	10	A TR 30	25.85	14.16	17.02	16.52	17.29	0.000741	2.31	11.18	7.18	0.59

River	Reach	River Sta	Plan	Q Total (m3/s)	Min Ch El (m)	W.S. Elev (m)	Crit W.S. (m)	E.G. Elev (m)	E.G. Slope (m/m)	Vel Chnl (m/s)	Flow Area (m2)	Top Width (m)	Froude # Chl
Botro_Cotone	Cotone_valle1	10	A TR 200_bis	31.31	14.16	17.32	16.71	17.60	0.000645	2.34	13.37	7.18	0.55
Botro_Cotone	Cotone_valle1	9.9	A TR 30	24.33	14.11	17.09	16.39	17.31	0.000556	2.05	11.87	7.18	0.51
Botro_Cotone	Cotone_valle1	9.9	A TR 200_bis	27.51	14.11	17.47	16.56	17.65	0.000394	1.89	14.53	7.18	0.42
Botro_Cotone	Cotone_valle1	9.5		Bridge									
Botro_Cotone	Cotone_valle1	9.1	A TR 30	24.32	13.89	15.86	16.04	16.83	0.003219	4.35	5.59	3.52	1.10
Botro_Cotone	Cotone_valle1	9.1	A TR 200_bis	27.50	13.89	15.97	16.25	17.05	0.003515	4.59	5.99	3.81	1.17
Botro_Cotone	Cotone_valle1	9	A TR 30	24.33	13.88	15.86	16.02	16.82	0.003190	4.34	5.61	3.52	1.10
Botro_Cotone	Cotone_valle1	9	A TR 200_bis	27.50	13.88	15.97	16.24	17.04	0.003487	4.57	6.01	3.80	1.16
Botro_Cotone	Cotone_valle1	8.998		Lat Struct									
Botro_Cotone	Cotone_valle1	8	A TR 30	22.17	13.20	16.10	15.19	16.33	0.000622	2.10	10.54	6.05	0.51
Botro_Cotone	Cotone_valle1	8	A TR 200_bis	22.29	13.20	16.32	15.20	16.50	0.000445	1.88	11.89	6.05	0.43
Botro_Cotone	Cotone_valle1	7.5		Bridge									
Botro_Cotone	Cotone_valle1	7	A TR 30	22.16	12.16	13.33	13.70	14.64	0.005587	5.06	4.38	3.85	1.52
Botro_Cotone	Cotone_valle1	7	A TR 200_bis	22.26	12.16	13.36	13.71	14.63	0.005358	4.99	4.46	3.86	1.48
Botro_Cotone	Cotone_valle1	6	A TR 30	22.87	10.77	13.57	12.32	13.71	0.000253	1.62	14.11	6.15	0.34
Botro_Cotone	Cotone_valle1	6	A TR 200_bis	23.28	10.77	13.59	12.33	13.73	0.000256	1.63	14.24	6.15	0.34
Botro_Cotone	Cotone_valle1	5.9	A TR 30	22.88	10.77	13.46	12.54	13.72	0.000714	2.24	10.21	6.03	0.55
Botro_Cotone	Cotone_valle1	5.9	A TR 200_bis	23.29	10.77	13.49	12.56	13.74	0.000714	2.25	10.34	6.03	0.55
Botro_Cotone	Cotone_valle1	5.5		Bridge									
Botro_Cotone	Cotone_valle1	5.1	A TR 30	22.86	10.42	12.18	12.15	12.99	0.001357	3.98	5.75	4.69	0.97
Botro_Cotone	Cotone_valle1	5.1	A TR 200_bis	23.29	10.42	12.22	12.17	13.02	0.001316	3.97	5.87	4.72	0.96
Botro_Cotone	Cotone_valle1	5	A TR 30	22.87	10.42	12.21	12.07	12.77	0.007119	3.33	6.88	4.71	0.88
Botro_Cotone	Cotone_valle1	5	A TR 200_bis	23.31	10.42	12.25	12.09	12.80	0.006783	3.28	7.10	4.75	0.86
Botro_Cotone	Cotone_valle1	4.998		Lat Struct									
Botro_Cotone	Cotone_valle1	4.997		Lat Struct									
Botro_Cotone	Cotone_valle1	4	A TR 30	12.70	8.27	11.38	9.97	11.63	0.005041	2.25	5.65	1.82	0.41
Botro_Cotone	Cotone_valle1	4	A TR 200_bis	12.79	8.27	11.39	9.98	11.65	0.005070	2.25	5.67	1.82	0.41
Botro_Cotone	Cotone_valle1	3.5		Bridge									
Botro_Cotone	Cotone_valle1	3	A TR 30	12.70	7.71	9.05	9.33	10.23	0.010682	4.83	2.63	4.95	1.35
Botro_Cotone	Cotone_valle1	3	A TR 200_bis	12.79	7.71	9.06	9.34	10.24	0.010332	4.79	2.67	4.99	1.33
Botro_Cotone	Cotone_valle1	2.98		Lat Struct									
Botro_Cotone	Cotone_valle1	2.97		Lat Struct									
Botro_Cotone	Cotone_valle1	2.1	A TR 30	13.74	6.99	8.31	8.32	8.72	0.008588	2.82	4.87	6.13	1.01
Botro_Cotone	Cotone_valle1	2.1	A TR 200_bis	14.24	6.99	8.38	8.34	8.75	0.007448	2.70	5.27	6.37	0.95
Botro_Cotone	Cotone_valle1	2	A TR 30	13.75	6.99	8.31	8.28	8.92	0.002798	3.48	3.95	3.00	0.97
Botro_Cotone	Cotone_valle1	2	A TR 200_bis	14.26	6.99	8.34	8.31	8.97	0.002815	3.52	4.05	3.00	0.97
Botro_Cotone	Cotone_valle1	1.9		Bridge									
Botro_Cotone	Cotone_valle1	1.81	A TR 30	13.75	4.95	5.76	6.24	7.41	0.011048	5.69	2.42	3.00	2.02
Botro_Cotone	Cotone_valle1	1.81	A TR 200_bis	14.25	4.95	5.77	6.27	7.47	0.011155	5.77	2.47	3.00	2.03
Botro_Cotone	Cotone_valle1	1.8	A TR 30	13.75	4.95	5.75	6.24	7.41	0.011084	5.70	2.41	3.00	2.03
Botro_Cotone	Cotone_valle1	1.8	A TR 200_bis	14.25	4.95	5.77	6.27	7.47	0.011203	5.78	2.46	3.00	2.04
Botro_Cotone	Cotone_valle2	1.71	A TR 30	23.84	4.93	5.75	6.32	7.77	0.011746	6.28	3.79	4.89	2.28
Botro_Cotone	Cotone_valle2	1.71	A TR 200_bis	24.65	4.93	5.77	6.35	7.83	0.011758	6.36	3.88	4.89	2.28
Botro_Cotone	Cotone_valle2	1.7	A TR 30	23.84	4.93	5.75	6.32	7.77	0.011801	6.29	3.79	4.89	2.28
Botro_Cotone	Cotone_valle2	1.7	A TR 200_bis	24.65	4.93	5.77	6.35	7.83	0.011812	6.37	3.87	4.89	2.28
Botro_Cotone	Cotone_valle2	1.5	A TR 30	23.84	1.10	1.66	2.49	6.26	0.041668	9.50	2.51	4.89	4.23
Botro_Cotone	Cotone_valle2	1.5	A TR 200_bis	24.65	1.10	1.67	2.52	6.39	0.041859	9.63	2.56	4.89	4.25
Botro_Cotone	Cotone_valle2	1.4	A TR 30	23.84	0.63	1.09	1.57	3.17	0.026071	6.39	3.73	8.90	3.15
Botro_Cotone	Cotone_valle2	1.4	A TR 200_bis	24.65	0.63	1.10	1.59	3.22	0.026045	6.46	3.82	8.90	3.15
Botro_Cotone	Cotone_valle2	1.1	A TR 30	23.84	0.37	0.84	1.31	2.83	0.024366	6.24	3.82	8.90	3.04
Botro_Cotone	Cotone_valle2	1.1	A TR 200_bis	24.65	0.37	0.85	1.33	2.89	0.024431	6.32	3.90	8.90	3.05
Botro_Cotone	Cotone_valle2	1	A TR 30	23.84	0.37	0.84	1.21	2.24	0.012943	5.25	4.54	12.50	2.55
Botro_Cotone	Cotone_valle2	1	A TR 200_bis	24.65	0.37	0.85	1.23	2.29	0.012913	5.32	4.64	12.50	2.56
Botro_Bargingo	Bargingo	6	A TR 30	12.53	39.04	40.35	40.38	40.87	0.018784	3.19	3.93	4.14	1.05
Botro_Bargingo	Bargingo	6	A TR 200_bis	19.64	39.04	40.70	40.76	41.36	0.018674	3.58	5.49	4.70	1.06
Botro_Bargingo	Bargingo	5.999	A TR 30	12.53	39.04	40.35	40.38	40.87	0.018886	3.19	3.92	4.14	1.05
Botro_Bargingo	Bargingo	5.999	A TR 200_bis	19.64	39.04	40.70	40.76	41.36	0.018753	3.59	5.48	4.70	1.06

River	Reach	River Sta	Plan	Q Total (m3/s)	Min Ch El (m)	W.S. Elev (m)	Crit W.S. (m)	E.G. Elev (m)	E.G. Slope (m/m)	Vel Chnl (m/s)	Flow Area (m2)	Top Width (m)	Froude # Chl
Botro_Bargingo	Bargingo	5.997		Lat Struct									
Botro_Bargingo	Bargingo	5	A TR 30	12.52	36.66	38.09	38.11	38.60	0.018342	3.17	3.95	4.06	1.03
Botro_Bargingo	Bargingo	5	A TR 200_bis	19.47	36.66	38.42	38.64	39.07	0.018783	3.59	5.71	12.53	1.06
Botro_Bargingo	Bargingo	4.2	A TR 30	12.05	34.59	36.07	35.67	36.21	0.003547	1.68	8.38	15.06	0.50
Botro_Bargingo	Bargingo	4.2	A TR 200_bis	17.89	34.59	36.31	36.04	36.46	0.003310	1.84	12.43	19.12	0.50
Botro_Bargingo	Bargingo	4.1	A TR 30	10.09	34.71	35.95	35.66	36.11	0.005139	1.80	6.15	12.76	0.59
Botro_Bargingo	Bargingo	4.1	A TR 200_bis	15.30	34.71	36.21	36.00	36.37	0.004105	1.89	10.07	17.40	0.55
Botro_Bargingo	Bargingo	4.05		Inl Struct									
Botro_Bargingo	Bargingo	4	A TR 30	14.14	32.41	34.03	33.52	34.25	0.005758	2.07	6.82	4.63	0.55
Botro_Bargingo	Bargingo	4	A TR 200_bis	25.56	32.41	34.90	34.02	35.18	0.005432	2.34	10.93	5.16	0.51
Botro_Bargingo	Bargingo	3.998		Lat Struct									
Botro_Bargingo	Bargingo	3.997		Lat Struct									
Botro_Bargingo	Bargingo	3	A TR 30	11.87	31.16	33.58	32.49	33.77	0.003918	1.94	6.13	4.96	0.40
Botro_Bargingo	Bargingo	3	A TR 200_bis	19.52	31.16	34.66	33.00	34.87	0.004320	2.05	10.10	4.96	0.39
Botro_Bargingo	Bargingo	2.5		Bridge									
Botro_Bargingo	Bargingo	2	A TR 30	11.87	31.16	32.34	32.46	33.09	0.026130	3.85	3.08	3.66	1.17
Botro_Bargingo	Bargingo	2	A TR 200_bis	19.52	31.16	32.66	32.94	33.88	0.033096	4.89	3.99	8.64	1.30
Botro_Bargingo	Bargingo	1	A TR 30	11.78	29.66	31.06	31.15	31.61	0.022207	3.30	3.57	4.25	1.15
Botro_Bargingo	Bargingo	1	A TR 200_bis	19.30	29.66	31.51	31.64	32.07	0.015848	3.32	6.07	9.38	1.01
Botro_Bargingo	Bargingo	0.9	A TR 30	11.76	29.08	30.65	30.64	31.12	0.017529	3.06	3.85	3.94	0.99
Botro_Bargingo	Bargingo	0.9	A TR 200_bis	19.07	29.08	31.25	31.05	31.68	0.011088	2.90	6.58	5.09	0.81
Botro Secco	Secco	25	A TR 30	8.66	51.28	52.91	51.94	52.95	0.001240	0.88	9.89	9.94	0.28
Botro Secco	Secco	25	A TR 200_bis	13.92	51.28	53.93	52.19	53.95	0.000326	0.58	24.05	17.71	0.16
Botro Secco	Secco	24	A TR 30	8.66	51.09	52.59	52.18	52.88	0.011811	2.38	3.64	2.42	0.62
Botro Secco	Secco	24	A TR 200_bis	13.92	51.09	53.70	52.59	53.95	0.007665	2.20	6.32	2.42	0.44
Botro Secco	Secco	23.8	A TR 30	8.66	51.07	52.57	52.16	52.86	0.011867	2.38	3.63	2.42	0.62
Botro Secco	Secco	23.8	A TR 200_bis	13.92	51.07	53.69	52.57	53.94	0.007624	2.20	6.33	2.42	0.43
Botro Secco	Secco	23.5		Bridge									
Botro Secco	Secco	23	A TR 30	8.66	50.85	51.82	51.95	52.53	0.039280	3.73	2.32	2.38	1.21
Botro Secco	Secco	23	A TR 200_bis	13.92	50.85	52.13	52.37	53.19	0.048528	4.56	3.05	2.38	1.29
Botro Secco	Secco	22	A TR 30	8.66	49.21	49.88	49.98	50.29	0.029438	2.84	3.05	6.64	1.34
Botro Secco	Secco	22	A TR 200_bis	13.92	49.21	50.05	50.20	50.59	0.029021	3.28	4.25	7.36	1.38
Botro Secco	Secco	21	A TR 30	9.65	45.62	47.09	46.45	47.22	0.003943	1.61	5.98	4.07	0.43
Botro Secco	Secco	21	A TR 200_bis	15.42	45.62	47.64	46.75	47.82	0.004186	1.88	8.23	4.37	0.42
Botro Secco	Secco	20.5		Bridge									
Botro Secco	Secco	20	A TR 30	9.75	45.55	46.88	46.37	47.04	0.004958	1.75	5.56	4.18	0.48
Botro Secco	Secco	20	A TR 200_bis	15.42	45.55	47.39	46.66	47.60	0.005053	2.00	7.70	4.18	0.47
Botro Secco	Secco	19	A TR 30	9.80	45.29	46.79	46.27	47.00	0.002988	2.04	4.80	5.81	0.53
Botro Secco	Secco	19	A TR 200_bis	15.54	45.29	47.26	46.63	47.56	0.003018	2.46	6.31	7.04	0.56
Botro Secco	Secco	18.5		Bridge									
Botro Secco	Secco	18	A TR 30	9.80	45.19	46.00	46.19	46.75	0.023987	3.84	2.55	5.95	1.36
Botro Secco	Secco	18	A TR 200_bis	15.54	45.19	46.26	46.54	47.34	0.023692	4.60	3.37	5.95	1.42
Botro Secco	Secco	17	A TR 30	10.91	41.85	43.99	42.95	44.14	0.001250	1.68	6.50	8.87	0.37
Botro Secco	Secco	17	A TR 200_bis	17.27	41.85	44.65	43.34	44.85	0.003042	2.02	8.82	10.45	0.47
Botro Secco	Secco	16.5		Bridge									
Botro Secco	Secco	16	A TR 30	11.52	41.86	43.34	43.25	43.83	0.021117	3.11	3.70	3.00	0.89
Botro Secco	Secco	16	A TR 200_bis	17.26	41.86	43.80	43.60	44.39	0.019702	3.39	5.10	3.45	0.83
Botro Secco	Secco	15.998		Lat Struct									
Botro Secco	Secco	15.997		Lat Struct									
Botro Secco	Secco	15	A TR 30	12.80	37.92	39.26	39.27	39.95	0.028988	3.68	3.47	2.60	1.02
Botro Secco	Secco	15	A TR 200_bis	20.08	37.92	39.80	39.75	40.66	0.029540	4.12	4.88	2.60	0.96
Botro Secco	Secco	14	A TR 30	13.75	34.75	36.38	36.04	36.78	0.010140	2.82	4.87	3.26	0.71
Botro Secco	Secco	14	A TR 200_bis	18.89	34.75	37.83	36.35	38.04	0.003168	2.04	9.25	3.51	0.37
Botro Secco	Secco	13.5		Bridge									
Botro Secco	Secco	13	A TR 30	13.75	30.57	32.12	32.01	32.72	0.014653	3.43	4.01	3.58	0.89
Botro Secco	Secco	13	A TR 200_bis	18.89	30.57	32.44	32.34	33.21	0.014614	3.89	4.85	3.62	0.92
Botro Secco	Secco	12	A TR 30	14.69	28.93	30.39	30.43	31.02	0.021350	3.51	4.18	3.63	1.05

River	Reach	River Sta	Plan	Q Total (m3/s)	Min Ch El (m)	W.S. Elev (m)	Crit W.S. (m)	E.G. Elev (m)	E.G. Slope (m/m)	Vel Chnl (m/s)	Flow Area (m2)	Top Width (m)	Froude # Chl
Botro Secco	Secco	12	A TR 200_bis	20.66	28.93	30.74	30.81	31.44	0.021081	3.70	5.58	4.52	1.06
Botro Secco	Secco	11.998		Lat Struct									
Botro Secco	Secco	11.997		Lat Struct									
Botro Secco	Secco	11	A TR 30	14.31	25.63	27.96	26.94	28.12	0.004193	1.73	8.27	5.29	0.44
Botro Secco	Secco	11	A TR 200_bis	18.37	25.63	28.21	27.21	28.40	0.004550	1.92	9.59	5.35	0.46
Botro Secco	Secco	10.5		Bridge									
Botro Secco	Secco	10	A TR 30	13.33	25.09	26.91	26.56	27.17	0.005437	2.25	5.93	4.92	0.65
Botro Secco	Secco	10	A TR 200_bis	17.32	25.09	27.06	26.77	27.40	0.006727	2.61	6.63	5.02	0.73
Botro Secco	Secco	9.98		Lat Struct									
Botro Secco	Secco	9.97		Lat Struct									
Botro Secco	Secco	9.7	A TR 30	11.60	24.96	26.91	26.34	27.08	0.003246	1.80	6.45	4.93	0.50
Botro Secco	Secco	9.7	A TR 200_bis	14.86	24.96	27.03	26.52	27.26	0.004197	2.12	7.07	7.11	0.57
Botro Secco	Secco	9.5		Inl Struct									
Botro Secco	Secco	9.3	A TR 30	15.14	24.26	26.70	25.94	26.81	0.002422	1.47	10.29	9.22	0.44
Botro Secco	Secco	9.3	A TR 200_bis	20.87	24.26	26.79	26.32	26.97	0.003612	1.87	11.13	9.22	0.54
Botro Secco	Secco	9.298		Lat Struct									
Botro Secco	Secco	9.297		Lat Struct									
Botro Secco	Secco	9	A TR 30	11.63	24.07	26.58	25.56	26.77	0.001422	1.92	6.07	9.22	0.41
Botro Secco	Secco	9	A TR 200_bis	14.04	24.07	26.78	25.72	27.02	0.001562	2.13	6.61	9.22	0.43
Botro Secco	Secco	8.5		Bridge									
Botro Secco	Secco	8.2	A TR 30	13.15	23.74	25.15	25.17	25.87	0.008778	3.75	3.50	4.57	1.02
Botro Secco	Secco	8.2	A TR 200_bis	14.03	23.74	25.24	25.23	25.96	0.008084	3.76	3.73	4.72	0.99
Botro Secco	Secco	8	A TR 30	13.23	23.65	25.10	24.96	25.47	0.008611	2.71	4.88	4.54	0.83
Botro Secco	Secco	8	A TR 200_bis	14.19	23.65	25.21	25.01	25.56	0.007563	2.63	5.39	4.71	0.79
Botro Secco	Secco	7	A TR 30	13.69	22.89	24.61	24.50	25.02	0.009948	2.81	4.88	4.65	0.88
Botro Secco	Secco	7	A TR 200_bis	15.43	22.89	24.72	24.60	25.14	0.009719	2.86	5.39	4.92	0.87
Botro Secco	Secco	6.8	A TR 30	13.70	22.87	24.60	24.48	25.00	0.010019	2.82	4.87	4.61	0.88
Botro Secco	Secco	6.8	A TR 200_bis	15.46	22.87	24.70	24.59	25.13	0.009868	2.88	5.37	4.88	0.88
Botro Secco	Secco	6.7		Bridge									
Botro Secco	Secco	6.5	A TR 30	13.70	22.84	24.39	24.46	24.98	0.016099	3.38	4.05	4.10	1.09
Botro Secco	Secco	6.5	A TR 200_bis	15.45	22.84	24.50	24.57	25.10	0.015583	3.43	4.50	4.37	1.08
Botro Secco	Secco	6.498		Lat Struct									
Botro Secco	Secco	6.497		Lat Struct									
Botro Secco	Secco	6	A TR 30	15.43	20.81	22.39	22.47	22.99	0.014881	3.43	4.49	4.53	1.10
Botro Secco	Secco	6	A TR 200_bis	18.84	20.81	22.56	22.64	23.21	0.014548	3.58	5.27	4.88	1.10
Botro Secco	Secco	5	A TR 30	9.16	17.75	20.38	19.01	20.41	0.000295	0.70	16.24	16.68	0.17
Botro Secco	Secco	5	A TR 200_bis	9.45	17.75	20.48	19.03	20.50	0.000243	0.66	17.91	16.68	0.16
Botro Secco	Secco	4.9	A TR 30	9.18	17.74	20.32	18.98	20.42	0.000719	1.42	6.47	6.78	0.29
Botro Secco	Secco	4.9	A TR 200_bis	9.48	17.74	20.42	19.00	20.52	0.000669	1.41	6.74	6.78	0.28
Botro Secco	Secco	4.5		Bridge									
Botro Secco	Secco	4.3	A TR 30	9.16	17.59	18.56	18.65	19.20	0.013616	3.55	2.58	4.09	1.15
Botro Secco	Secco	4.3	A TR 200_bis	9.48	17.59	18.59	18.68	19.23	0.013034	3.55	2.67	4.14	1.14
Botro Secco	Secco	4.298		Lat Struct									
Botro Secco	Secco	4.297		Lat Struct									
Botro Secco	Secco	4	A TR 30	9.19	17.57	18.54	18.56	18.96	0.014386	2.87	3.20	4.08	1.03
Botro Secco	Secco	4	A TR 200_bis	9.52	17.57	18.57	18.58	18.98	0.013684	2.85	3.34	4.13	1.01
Botro Secco	Secco	3	A TR 30	12.30	14.72	16.29	16.27	16.81	0.013803	3.20	3.84	3.52	0.98
Botro Secco	Secco	3	A TR 200_bis	14.06	14.72	16.42	16.40	16.96	0.013612	3.26	4.31	3.86	0.98
Botro Secco	Secco	2.1	A TR 30	14.81	12.53	14.72	14.10	14.87	0.002567	1.72	9.35	12.79	0.47
Botro Secco	Secco	2.1	A TR 200_bis	17.58	12.53	14.76	14.24	14.95	0.003261	1.97	9.84	12.79	0.53
Botro Secco	Secco	2	A TR 30	13.69	12.17	14.76	13.81	14.86	0.001701	1.42	10.56	12.79	0.37
Botro Secco	Secco	2	A TR 200_bis	15.82	12.17	14.82	13.95	14.94	0.001952	1.55	11.34	12.79	0.40
Botro Secco	Secco	1.1	A TR 30	10.19	12.16	14.84	13.29	14.88	0.000570	0.92	11.05	5.79	0.21
Botro Secco	Secco	1.1	A TR 200_bis	10.59	12.16	14.93	13.32	14.98	0.000540	0.91	11.58	5.79	0.21
Botro Secco	Secco	1	A TR 30	10.09	12.16	14.74	13.43	14.89	0.003761	1.74	5.81	2.25	0.35
Botro Secco	Secco	1	A TR 200_bis	10.41	12.16	14.84	13.46	14.99	0.003672	1.73	6.02	2.25	0.34

HEC-RAS Profile: Max WS (Continued)

River	Reach	River Sta	Plan	Q Total (m3/s)	Min Ch El (m)	W.S. Elev (m)	Crit W.S. (m)	E.G. Elev (m)	E.G. Slope (m/m)	Vel Chnl (m/s)	Flow Area (m2)	Top Width (m)	Froude # Chl
Botro Secco	Secco	0.99		Bridge									
Botro Secco	Secco	0.95	A TR 30	10.09	4.96	5.78	6.23	7.31	0.073517	5.49	1.84	2.25	1.94
Botro Secco	Secco	0.95	A TR 200_bis	10.40	4.96	5.79	6.26	7.36	0.073781	5.54	1.88	2.25	1.94
Botro Secco	Secco	0.9	A TR 30	10.09	4.95	5.75	6.22	7.35	0.077542	5.60	1.80	2.25	2.00
Botro Secco	Secco	0.9	A TR 200_bis	10.40	4.95	5.77	6.25	7.40	0.077727	5.65	1.84	2.25	1.99

River	Reach	River Sta	Plan	Q US (m3/s)	Q Leaving Total (m3/s)	Q DS (m3/s)	Q Weir (m3/s)	Q Gates (m3/s)	Wr Top Width (m)	Weir Max Depth (m)	Weir Avg Depth (m)	Min El Weir Flow (m)	E.G. U.S. (m)	W.S. U.S. (m)	E.G. DS (m)	W.S. DS (m)
Botro_Cotone	Cotone_valle1	11.68	A TR 30	25.47	0.00	26.47	0.00					18.59	21.83	18.91	19.40	17.36
Botro_Cotone	Cotone_valle1	11.68	A TR 200_bis	36.16	0.00	36.94	0.00					18.59	22.76	19.20	20.14	17.66
Botro_Cotone	Cotone_valle1	10.998	A TR 30	26.47	3.28	24.33	3.28	17.42	0.44	0.21	16.65	19.40	17.36	17.31	17.09	
Botro_Cotone	Cotone_valle1	10.998	A TR 200_bis	36.94	10.39	27.51	10.39	32.79	0.81	0.28	16.65	20.13	17.66	17.65	17.46	
Botro_Cotone	Cotone_valle1	8.998	A TR 30	24.33	2.56	22.17	2.56	14.83	0.45	0.20	15.65	16.82	15.86	16.32	16.10	
Botro_Cotone	Cotone_valle1	8.998	A TR 200_bis	27.50	5.55	22.29	5.55	18.86	0.67	0.28	15.65	17.03	15.97	16.50	16.32	
Botro_Cotone	Cotone_valle1	4.998	A TR 30	22.87	3.76	12.70	3.76	48.24	0.85	0.10	10.50	12.77	12.21	11.63	11.35	
Botro_Cotone	Cotone_valle1	4.998	A TR 200_bis	23.31	4.10	12.79	4.10	52.83	0.86	0.10	10.50	12.80	12.25	11.64	11.36	
Botro_Cotone	Cotone_valle1	4.997	A TR 30	22.87	8.18	12.70	8.18	67.24	0.96	0.15	10.39	12.77	12.21	11.63	11.35	
Botro_Cotone	Cotone_valle1	4.997	A TR 200_bis	23.31	8.85	12.79	8.85	71.04	0.97	0.15	10.39	12.80	12.25	11.64	11.36	
Botro_Cotone	Cotone_valle1	2.98	A TR 30	12.72	0.00	13.75	0.00				9.75	9.45	9.03	8.91	8.31	
Botro_Cotone	Cotone_valle1	2.98	A TR 200_bis	12.82	0.00	14.26	0.00				9.75	9.46	9.05	8.95	8.34	
Botro_Cotone	Cotone_valle1	2.97	A TR 30	12.72	0.00	13.75	0.00				9.61	9.45	9.03	8.91	8.31	
Botro_Cotone	Cotone_valle1	2.97	A TR 200_bis	12.82	0.00	14.26	0.00				9.61	9.46	9.05	8.95	8.34	
Botro_Bargingo	Bargingo	5.997	A TR 30	12.53	0.00	12.05	0.00				36.58	40.87	40.35	36.21	36.07	
Botro_Bargingo	Bargingo	5.997	A TR 200_bis	19.64	0.26	17.89	0.26	29.28	0.06	0.03	36.58	41.36	40.70	36.46	36.31	
Botro_Bargingo	Bargingo	3.998	A TR 30	14.14	3.82	11.87	3.82	41.92	0.42	0.20	33.26	34.25	34.03	33.77	33.59	
Botro_Bargingo	Bargingo	3.998	A TR 200_bis	25.56	21.84	19.52	21.84	72.90	1.54	1.13	33.26	35.18	34.90	34.87	34.66	
Botro_Bargingo	Bargingo	3.997	A TR 30	14.14	0.00	11.87	0.00				34.70	34.25	34.03	33.77	33.59	
Botro_Bargingo	Bargingo	3.997	A TR 200_bis	25.56	0.09	19.52	0.09	19.02	0.13	0.07	34.70	35.18	34.90	34.87	34.66	
Botro_Secco	Secco	15.998	A TR 30	11.52	0.00	13.75	0.00				37.45	43.83	43.33	36.78	36.38	
Botro_Secco	Secco	15.998	A TR 200_bis	17.26	1.68	18.89	1.68	11.12	0.38	0.18	37.45	44.38	43.80	38.04	37.83	
Botro_Secco	Secco	15.997	A TR 30	11.52	0.00	13.75	0.00				37.51	43.83	43.33	36.78	36.38	
Botro_Secco	Secco	15.997	A TR 200_bis	17.26	1.21	18.89	1.21	9.97	0.32	0.16	37.51	44.38	43.80	38.04	37.83	
Botro_Secco	Secco	11.998	A TR 30	14.69	0.25	14.31	0.25	6.74	0.14	0.07	27.82	31.02	30.39	28.12	27.96	
Botro_Secco	Secco	11.998	A TR 200_bis	20.66	2.18	18.37	2.18	15.72	0.39	0.17	27.82	31.44	30.74	28.40	28.21	
Botro_Secco	Secco	11.997	A TR 30	14.69	0.00	14.31	0.00				28.09	31.02	30.39	28.12	27.96	
Botro_Secco	Secco	11.997	A TR 200_bis	20.66	0.11	18.37	0.11	4.08	0.12	0.06	28.09	31.44	30.74	28.40	28.21	
Botro_Secco	Secco	9.98	A TR 30	13.33	0.00	11.60	0.00				26.97	27.17	26.91	27.08	26.91	
Botro_Secco	Secco	9.98	A TR 200_bis	17.32	0.36	14.86	0.36	14.35	0.09	0.06	26.97	27.40	27.06	27.26	27.03	
Botro_Secco	Secco	9.97	A TR 30	13.33	0.00	11.60	0.00				27.02	27.17	26.91	27.08	26.91	
Botro_Secco	Secco	9.97	A TR 200_bis	17.32	0.03	14.86	0.03	11.70	0.04	0.01	27.02	27.40	27.06	27.26	27.03	
Botro_Secco	Secco	9.298	A TR 30	15.14	0.43	11.63	0.43	11.88	0.10	0.07	26.62	26.81	26.70	26.77	26.58	
Botro_Secco	Secco	9.298	A TR 200_bis	20.87	2.05	14.04	2.05	13.63	0.23	0.20	26.62	26.97	26.79	27.01	26.79	
Botro_Secco	Secco	9.297	A TR 30	15.14	1.85	11.63	1.85	13.63	0.22	0.18	26.50	26.81	26.70	26.77	26.58	
Botro_Secco	Secco	9.297	A TR 200_bis	20.87	4.18	14.04	4.18	13.63	0.35	0.32	26.50	26.97	26.79	27.01	26.79	
Botro_Secco	Secco	6.498	A TR 30	13.70	7.17	9.16	7.17	28.70	0.59	0.25	19.79	24.98	24.39	20.41	20.38	
Botro_Secco	Secco	6.498	A TR 200_bis	15.45	11.17	9.45	11.17	45.77	0.69	0.24	19.79	25.10	24.50	20.50	20.48	
Botro_Secco	Secco	6.497	A TR 30	13.70	2.07	9.16	2.07	14.04	0.37	0.18	20.01	24.98	24.39	20.41	20.38	
Botro_Secco	Secco	6.497	A TR 200_bis	15.45	3.55	9.45	3.55	18.79	0.47	0.21	20.01	25.10	24.50	20.50	20.48	
Botro_Secco	Secco	4.298	A TR 30	9.16	3.82	10.09	3.82	26.07	0.35	0.18	14.49	19.18	18.56	14.89	14.75	
Botro_Secco	Secco	4.298	A TR 200_bis	9.48	5.55	10.41	5.55	28.87	0.44	0.22	14.49	19.22	18.59	14.99	14.85	
Botro_Secco	Secco	4.297	A TR 30	9.16	1.48	10.09	1.48	17.32	0.36	0.11	14.48	19.18	18.56	14.89	14.75	
Botro_Secco	Secco	4.297	A TR 200_bis	9.48	2.56	10.41	2.56	19.16	0.45	0.16	14.48	19.22	18.59	14.99	14.85	

HEC-RAS Profile: Max WS

Storage Area	Plan	W.S. Elev (m)	SA Min El (m)	Net Flux (m3/s)	SA Area (1000 m2)	SA Volume (1000 m3)
BA_S1	A TR 30	32.10	32.10	0.00	0.02	0.00
BA_S1	A TR 200_bis	34.81	32.10	0.35	0.20	0.19
SA_BA_2	A TR 30	33.68	32.91	3.82	0.33	0.25
SA_BA_2	A TR 200_bis	34.80	32.91	21.84	0.68	0.90

Fosso dei Morti

Stato attuale



None of the XS's are Geo-Referenced (Geo-Ref user entered XS, Geo-Ref interpolated XS, Non Geo-Ref user entered XS, Non Geo-Ref interpolated XS)

1 cm Horiz. = 116 m 1 cm Vert. = 95 m

1) A TR30 2) ATR200

N.B. in grigio sono indicati gli sfioratori laterali in destra idrografica

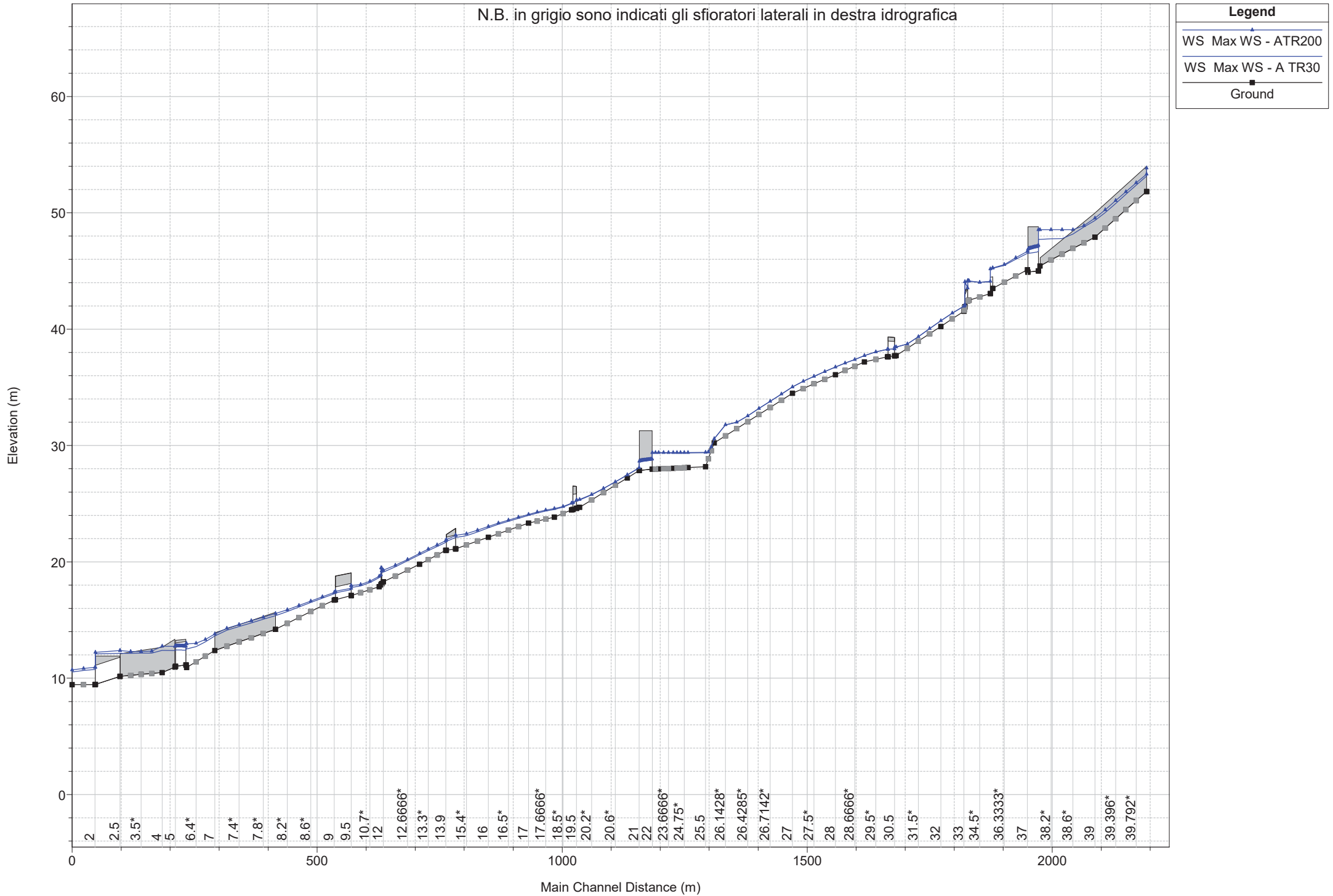

1) A TR30 2) ATR200

N.B. in grigio sono indicati gli sfioratori laterali in sinistra idrografica

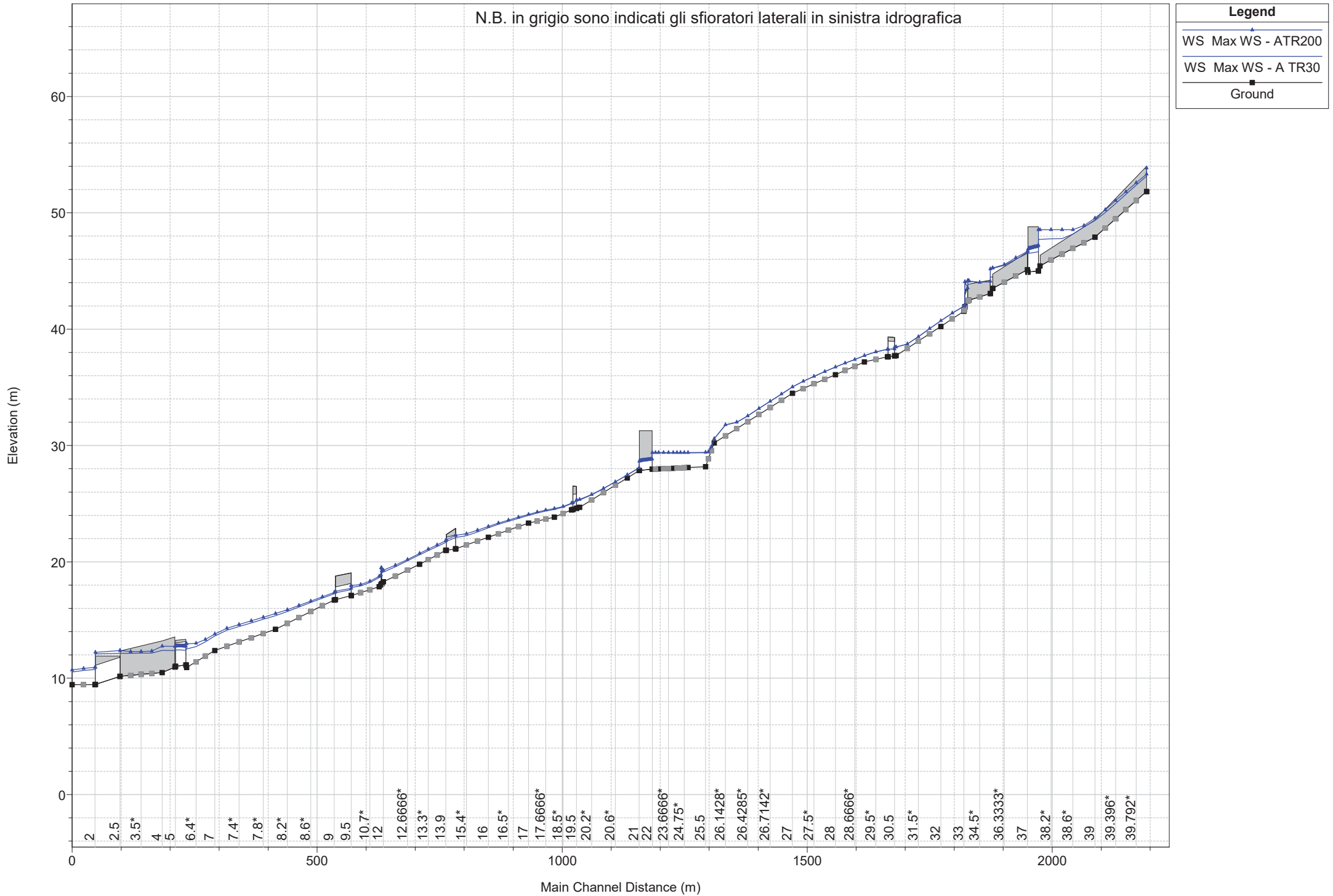

1 cm Horiz. = 95 m 1 cm Vert. = 4 m

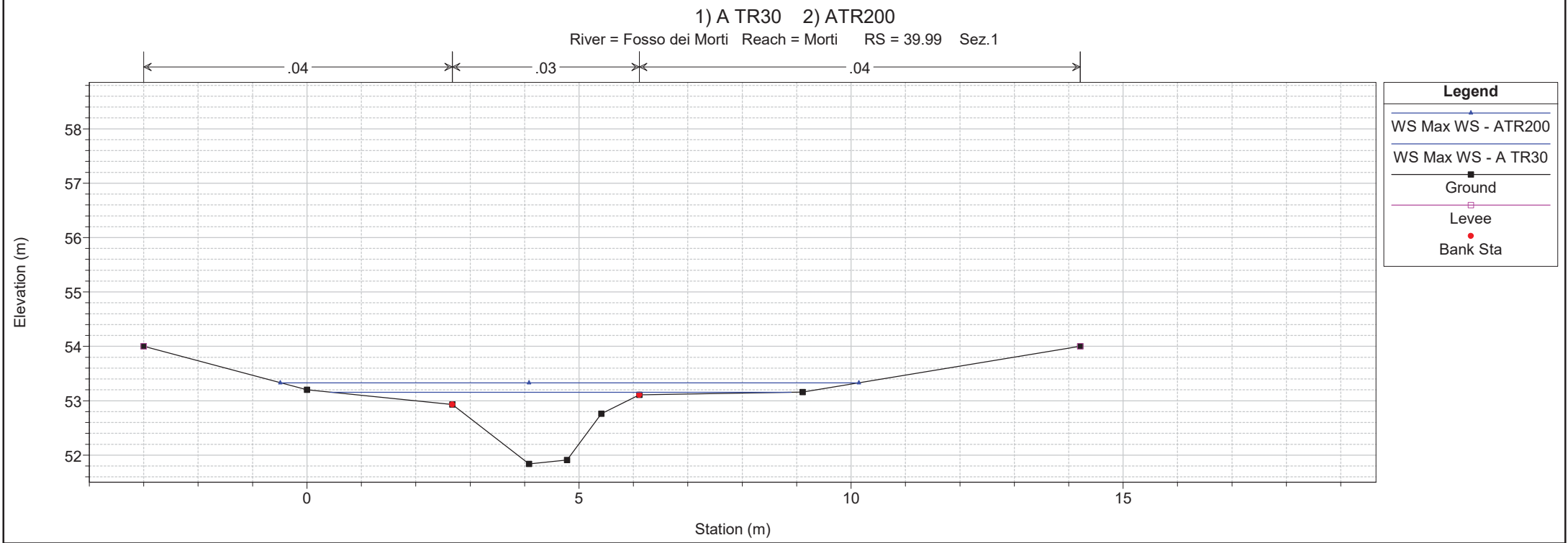
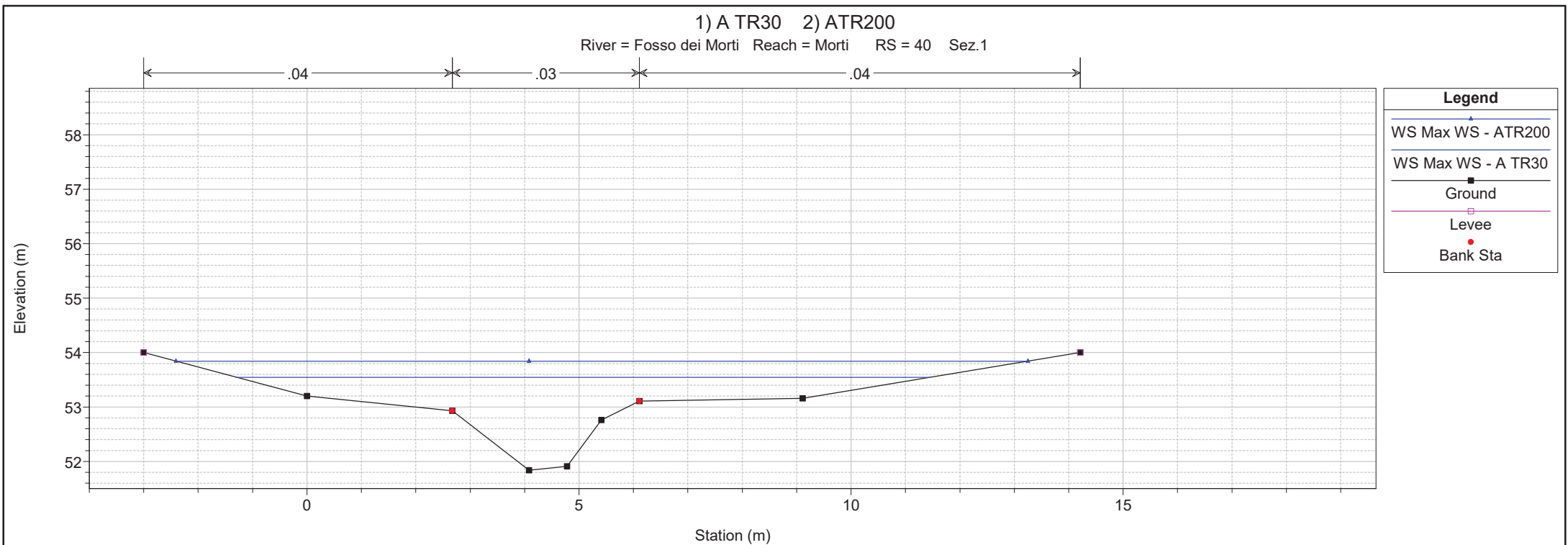

1 cm Horiz. = 1 m 1 cm Vert. = 1 m

1) A TR30 2) ATR200

River = Fosso dei Morti Reach = Morti RS = 39 Sez.2

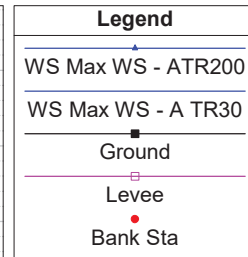
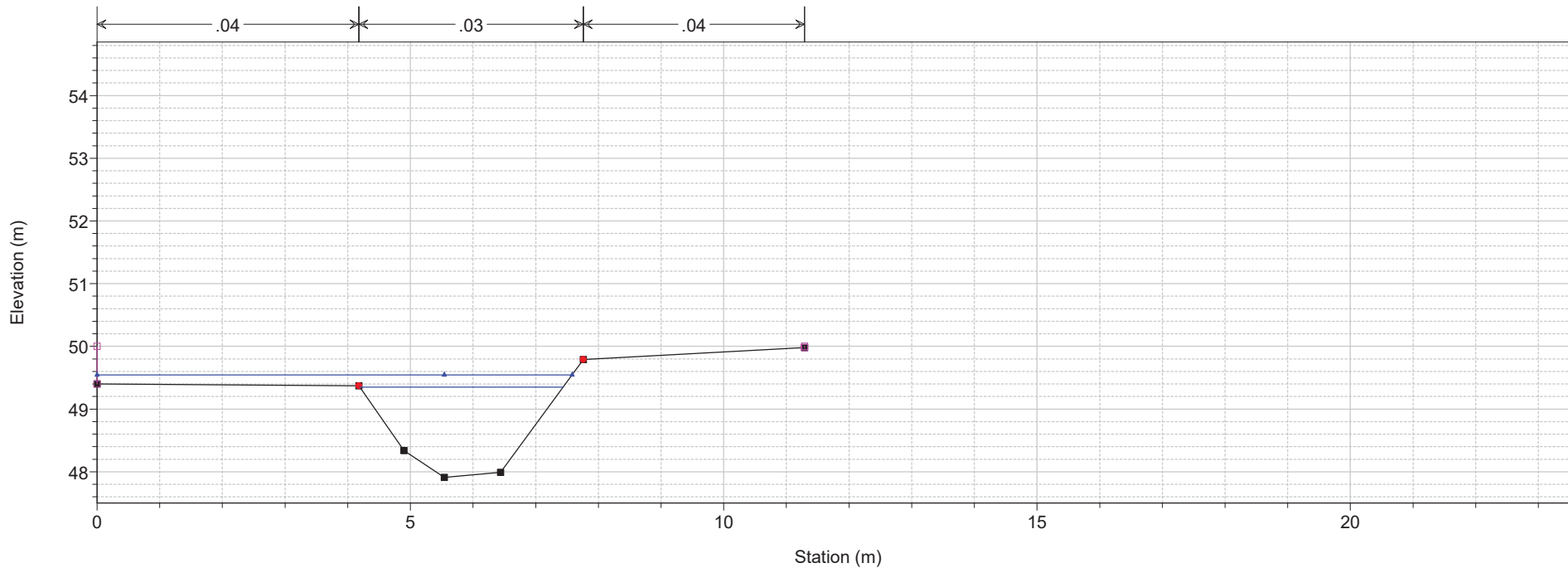

1) A TR30 2) ATR200

River = Fosso dei Morti Reach = Morti RS = 38 Sez. 3

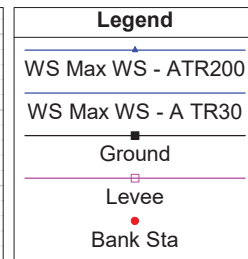
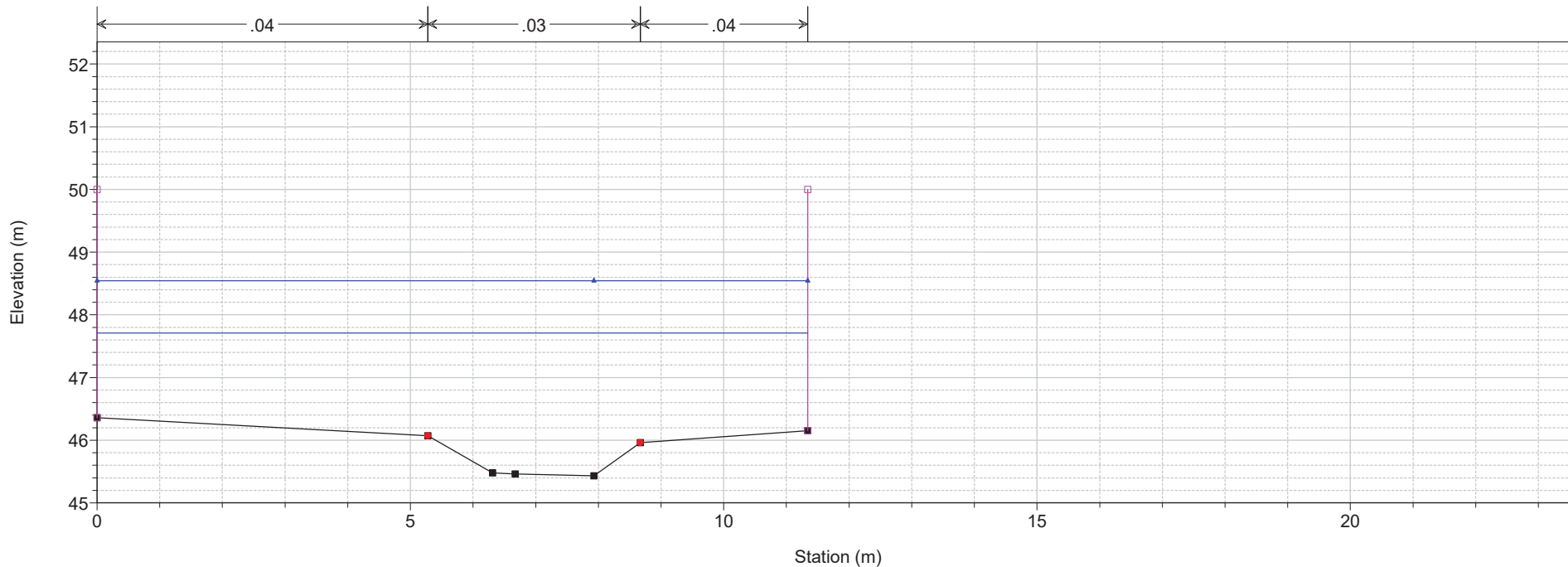

1) A TR30 2) ATR200

River = Fosso dei Morti Reach = Morti RS = 37.9

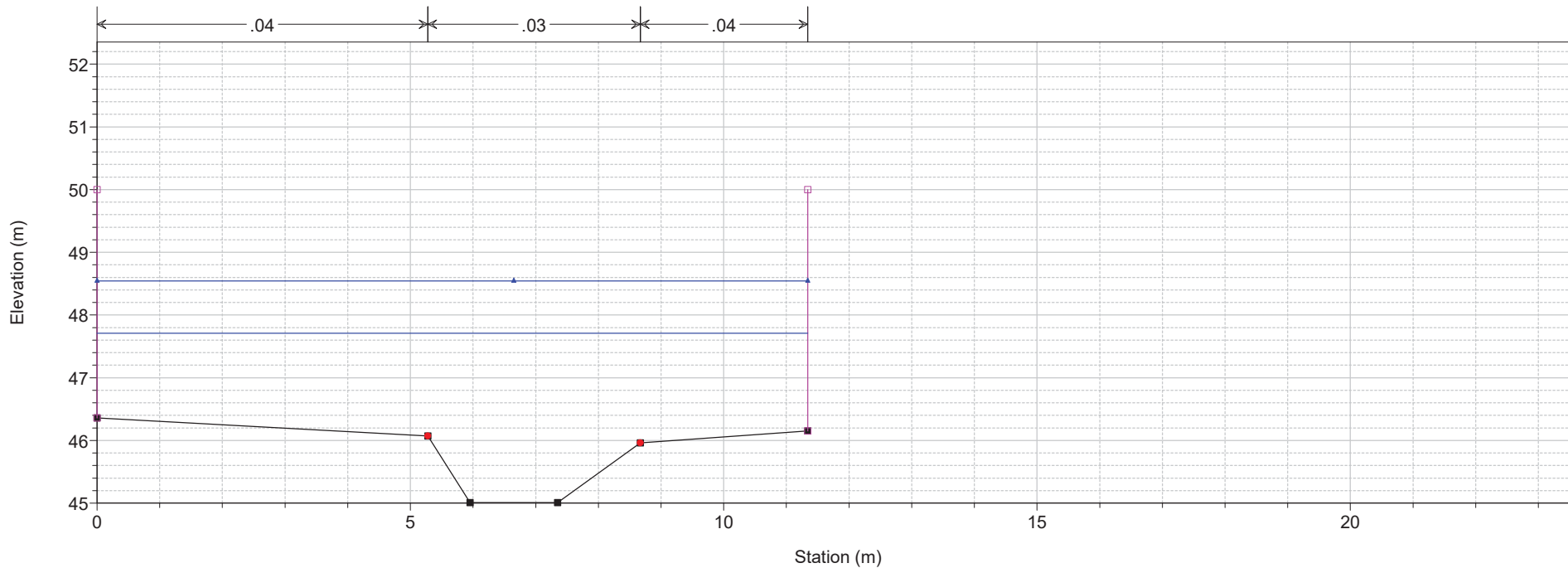

1) A TR30 2) ATR200

River = Fosso dei Morti Reach = Morti RS = 37.5 Culv

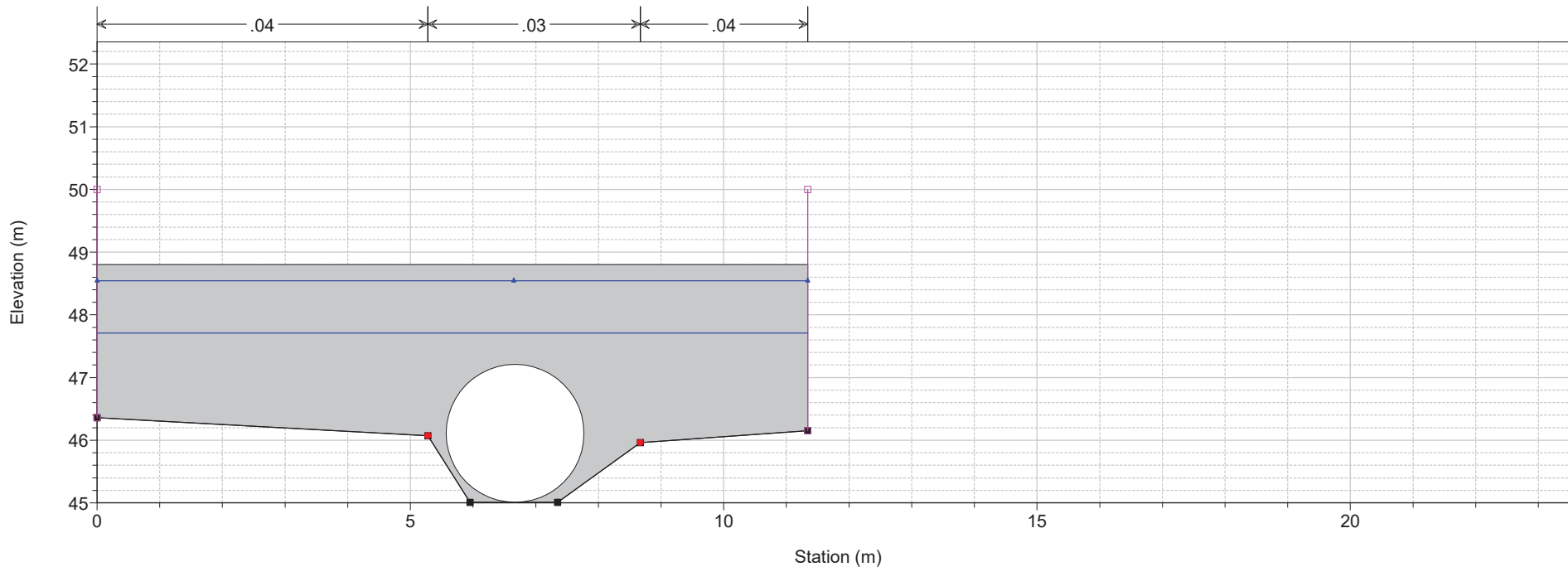

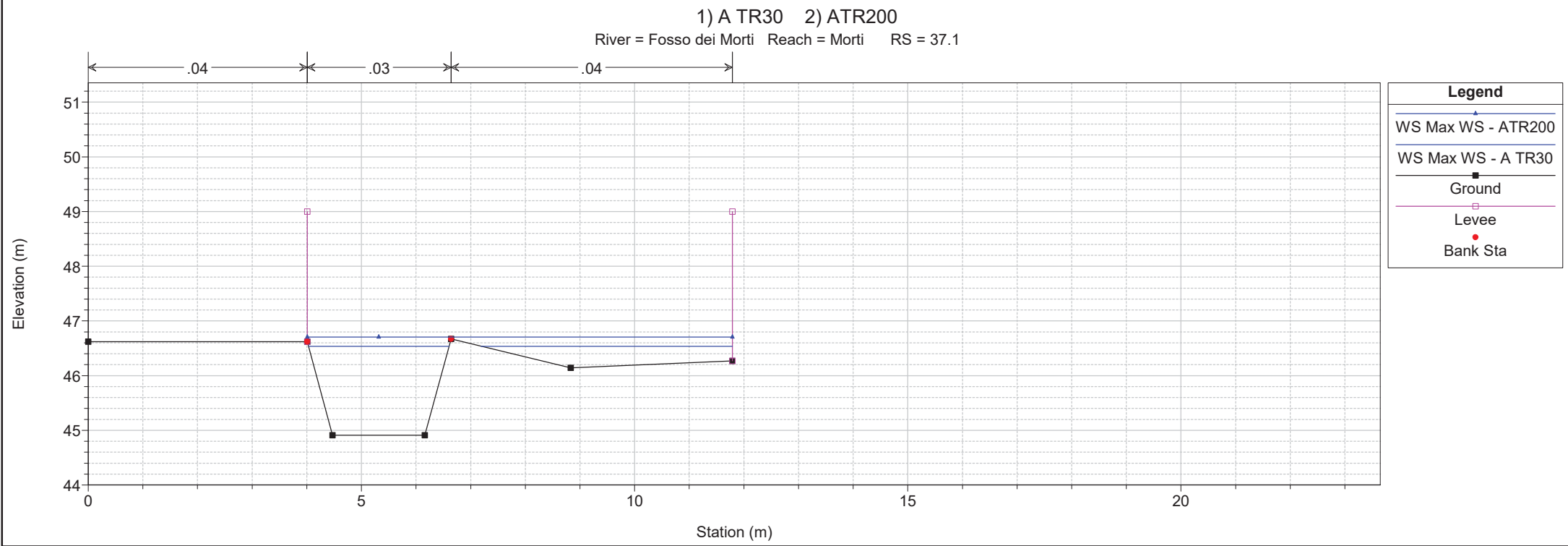
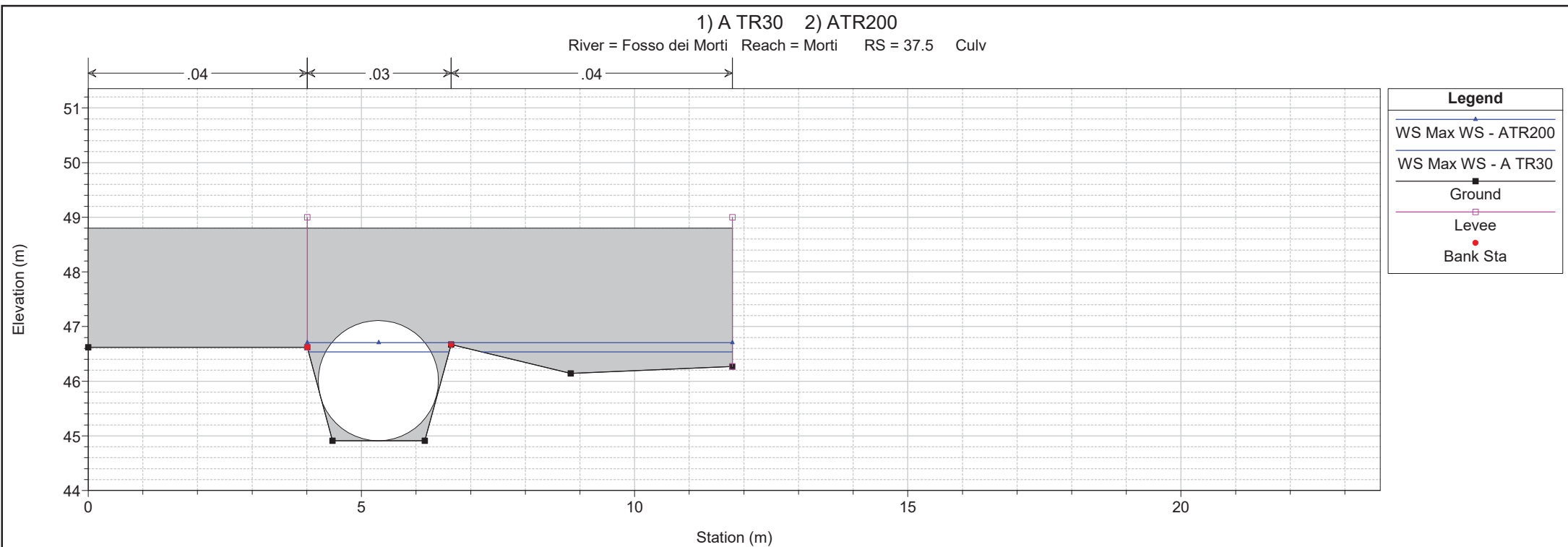

1) A TR30 2) ATR200
 River = Fosso dei Morti Reach = Morti RS = 37 Sez. 4

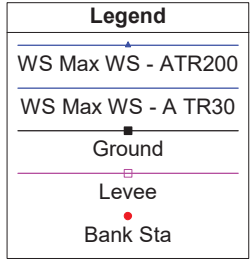
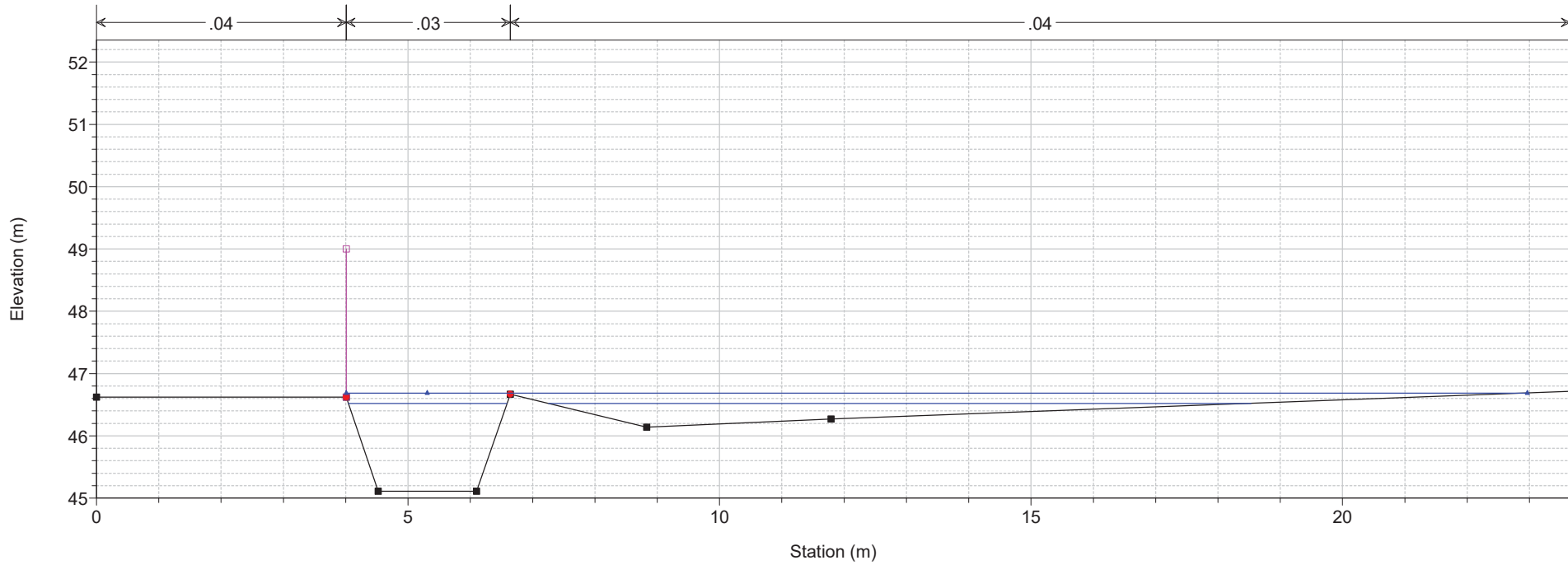

1) A TR30 2) ATR200
 River = Fosso dei Morti Reach = Morti RS = 36 Sez. 5

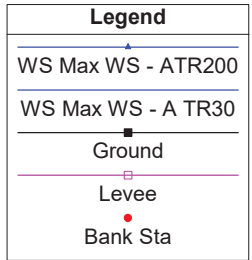
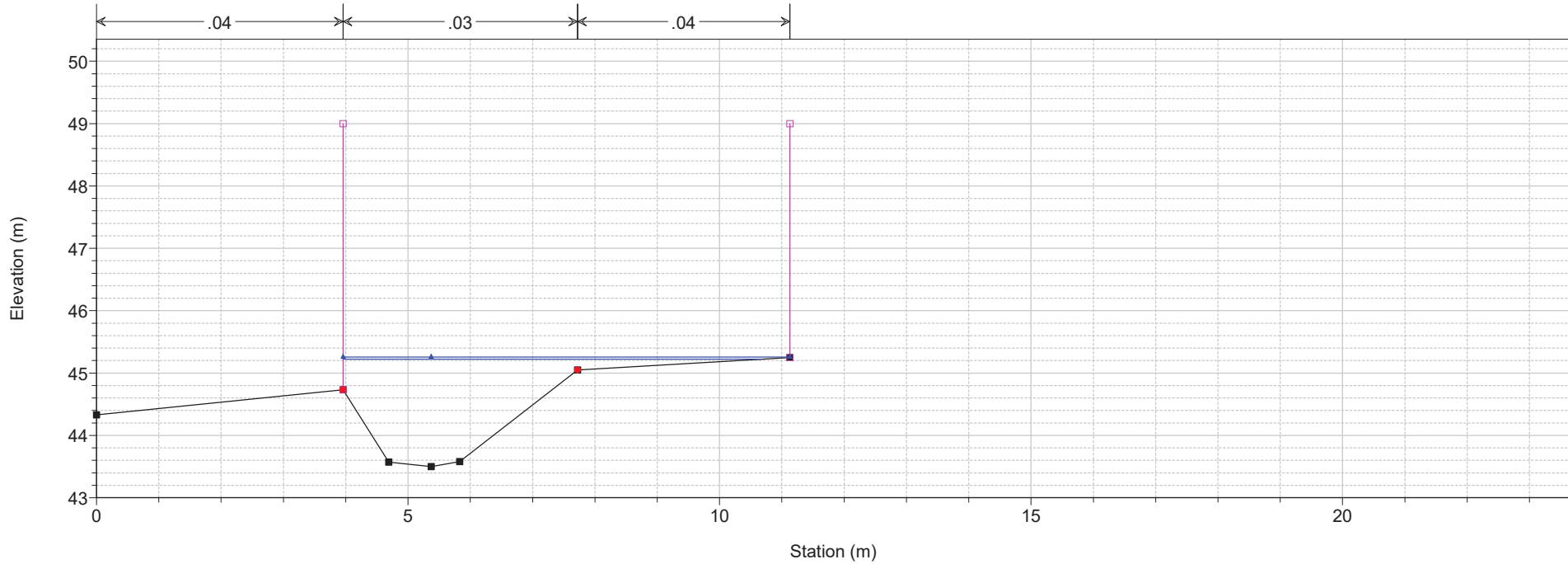

1) A TR30 2) ATR200

River = Fosso dei Morti Reach = Morti RS = 35.5 Culv

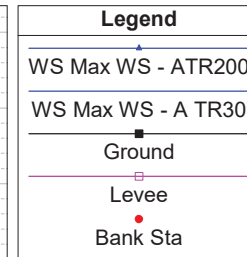
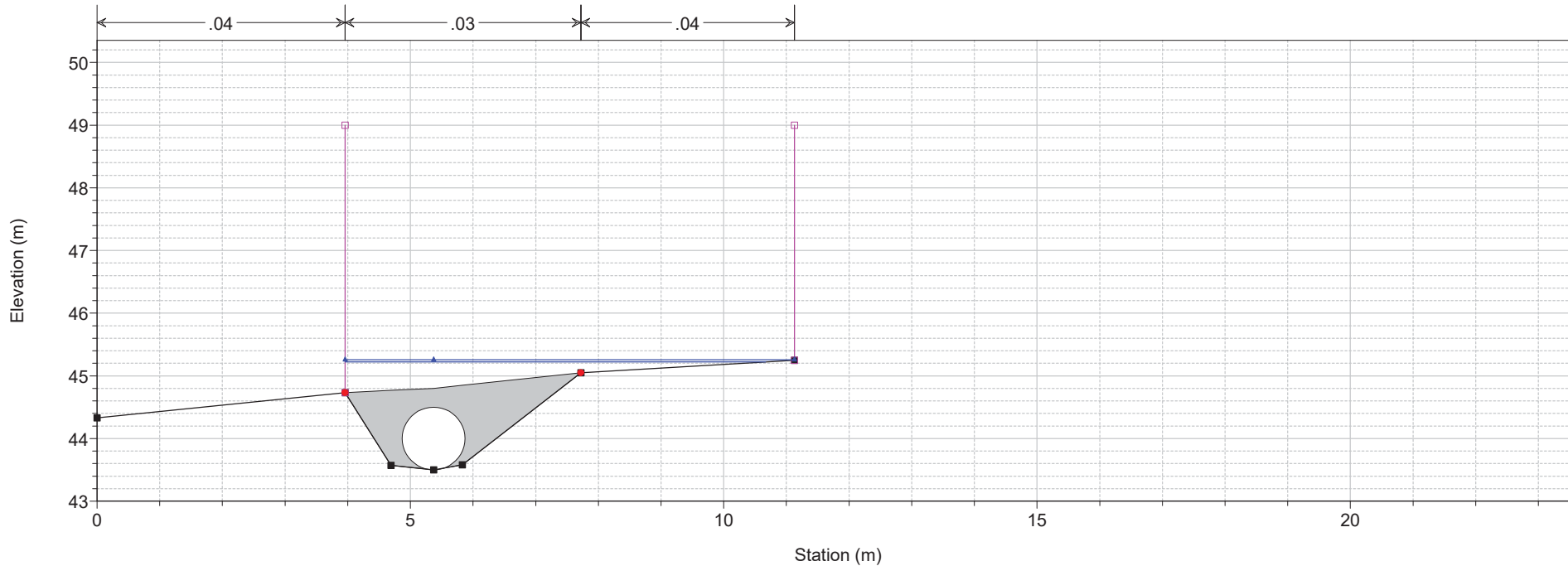

1) A TR30 2) ATR200

River = Fosso dei Morti Reach = Morti RS = 35.5 Culv

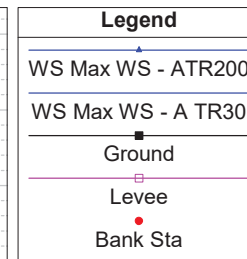
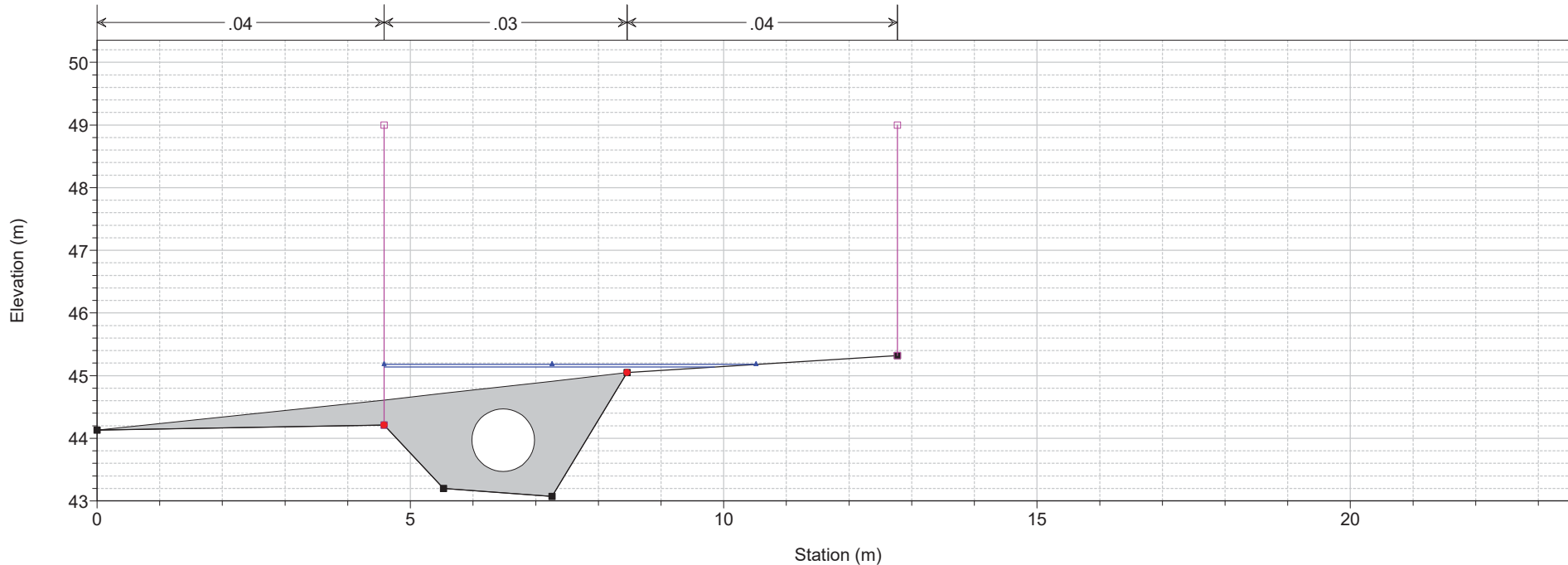

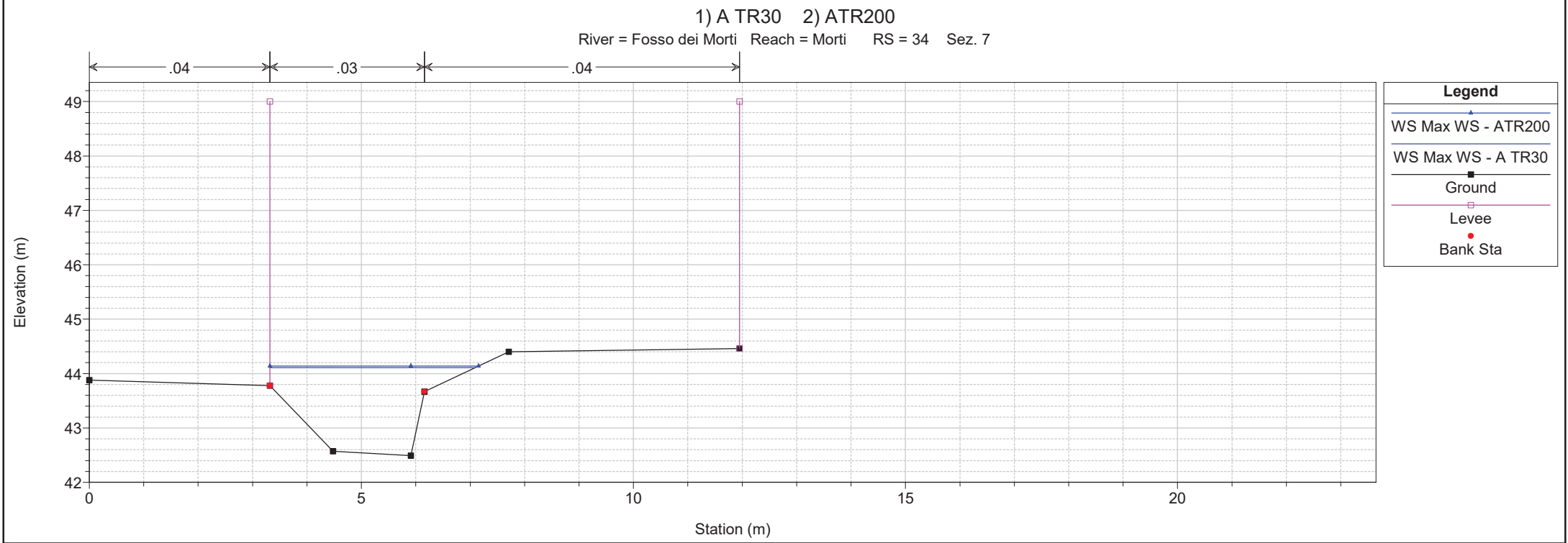
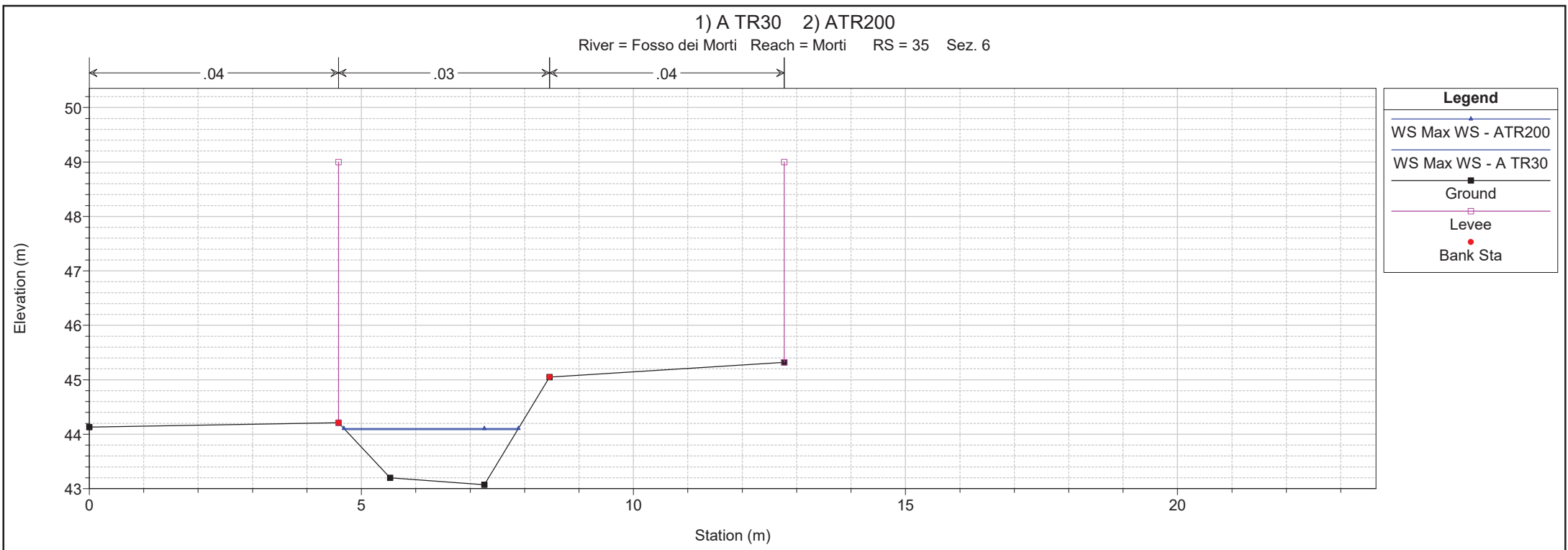

1 cm Horiz. = 1 m 1 cm Vert. = 1 m

1) A TR30 2) ATR200

River = Fosso dei Morti Reach = Morti RS = 33.9

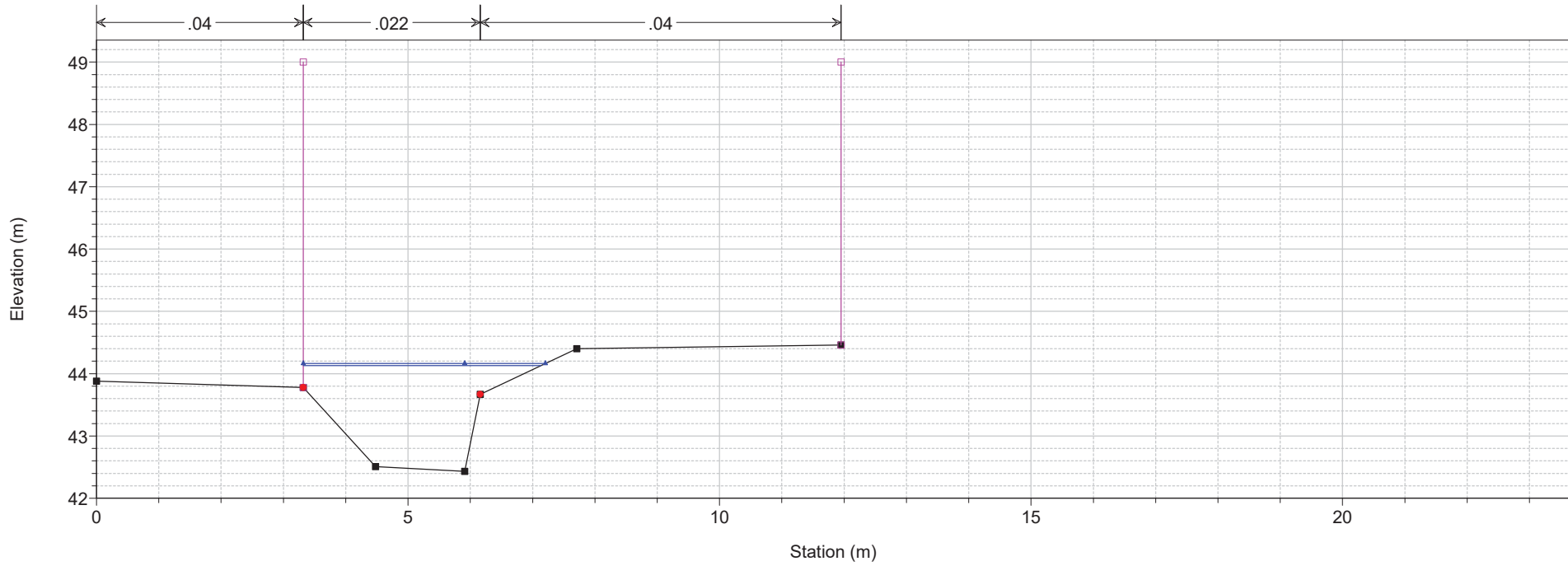

1) A TR30 2) ATR200

River = Fosso dei Morti Reach = Morti RS = 33.5 BR

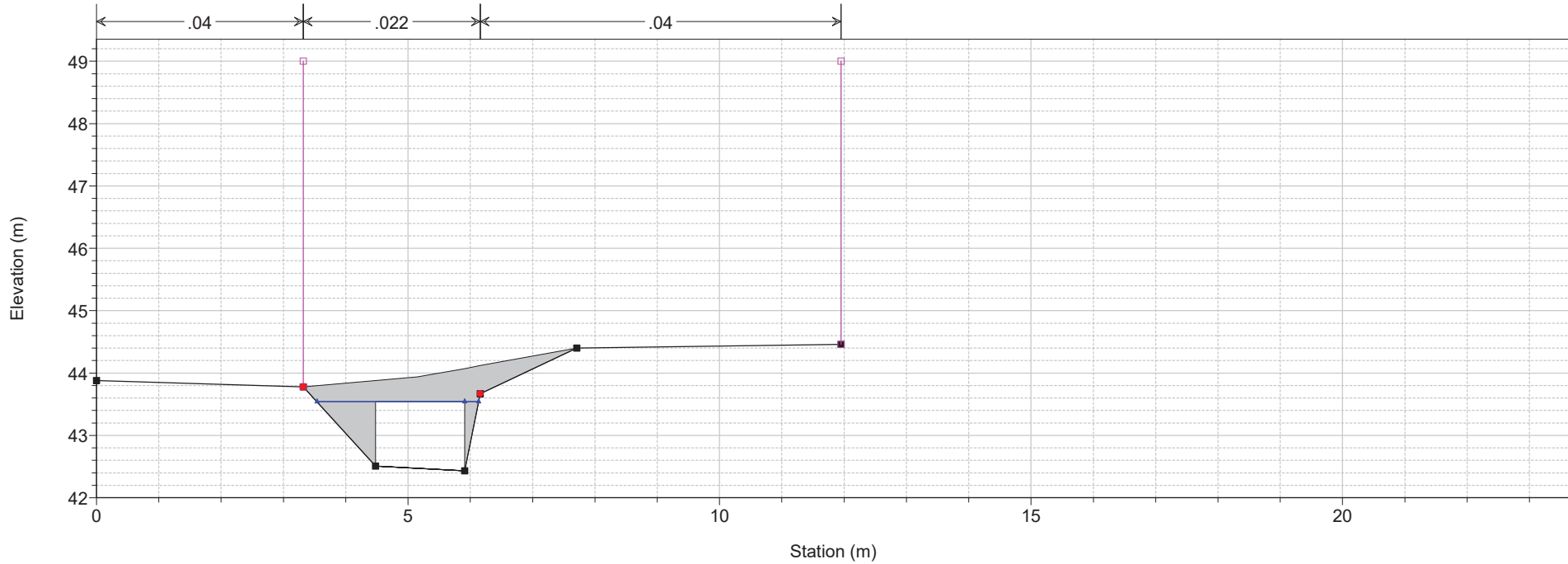

1 cm Horiz. = 1 m 1 cm Vert. = 1 m

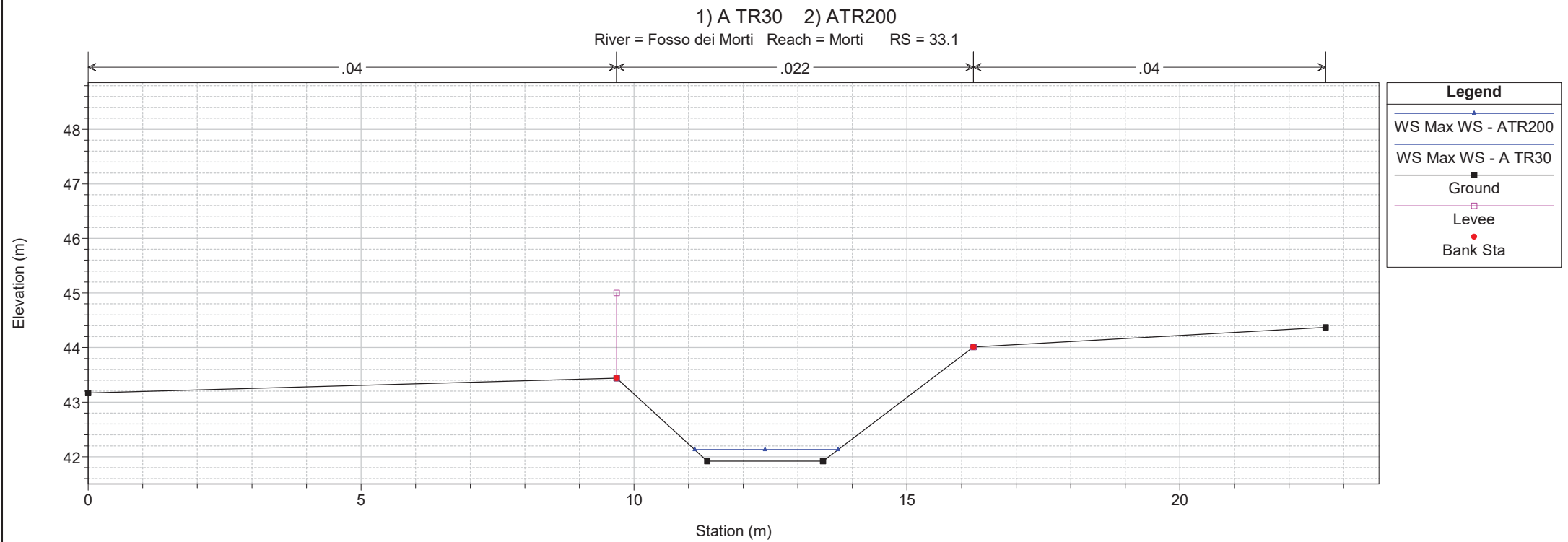
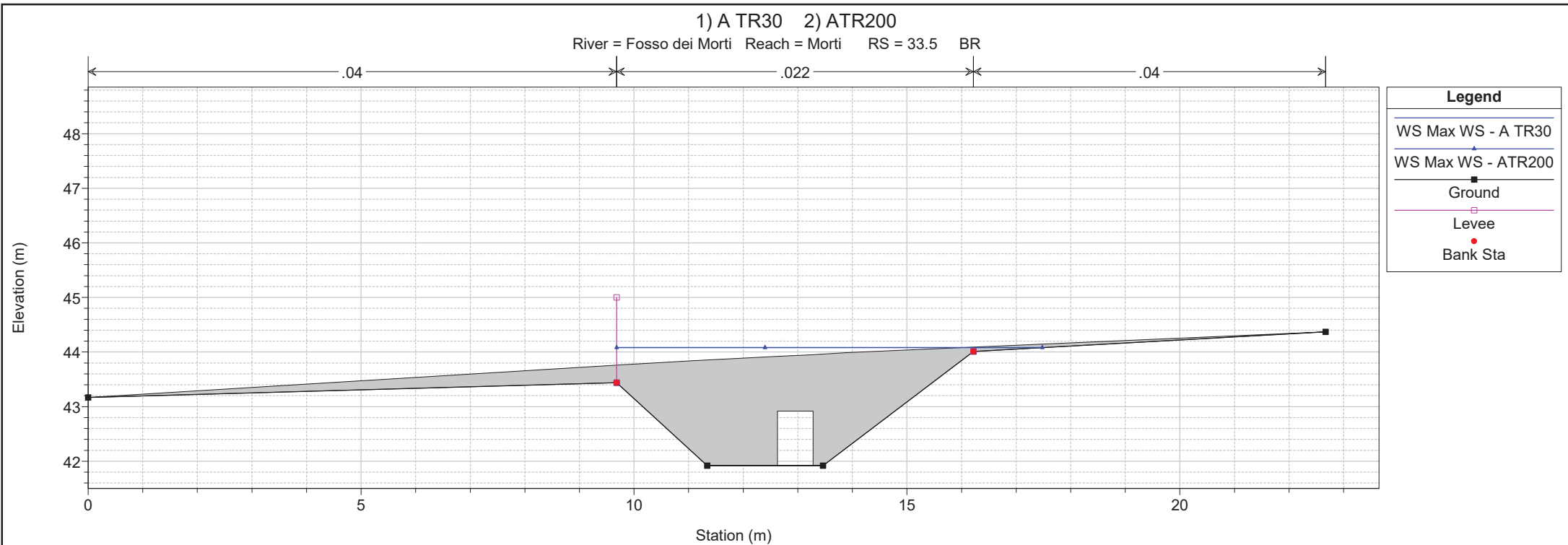

1) A TR30 2) ATR200

River = Fosso dei Morti Reach = Morti RS = 33 Sez. 8

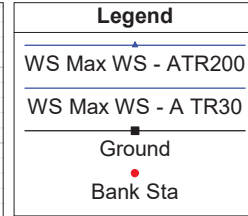
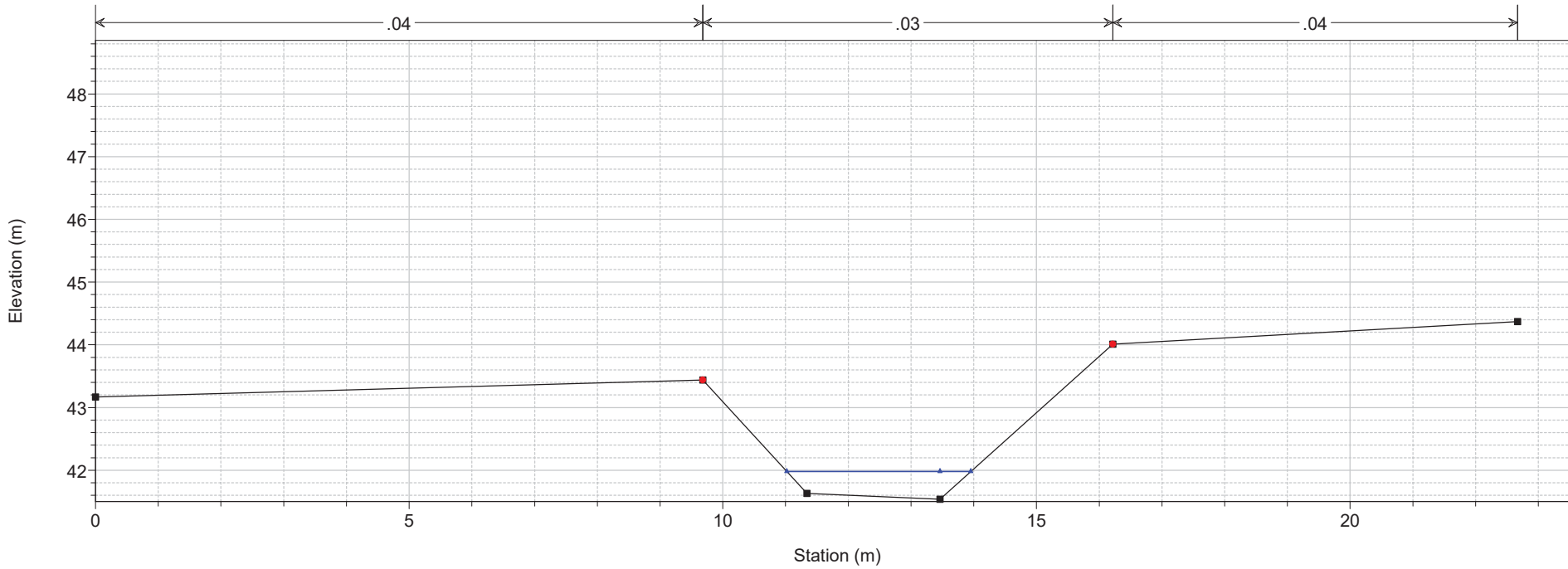

1) A TR30 2) ATR200

River = Fosso dei Morti Reach = Morti RS = 32 Sez. 9

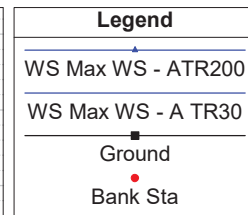
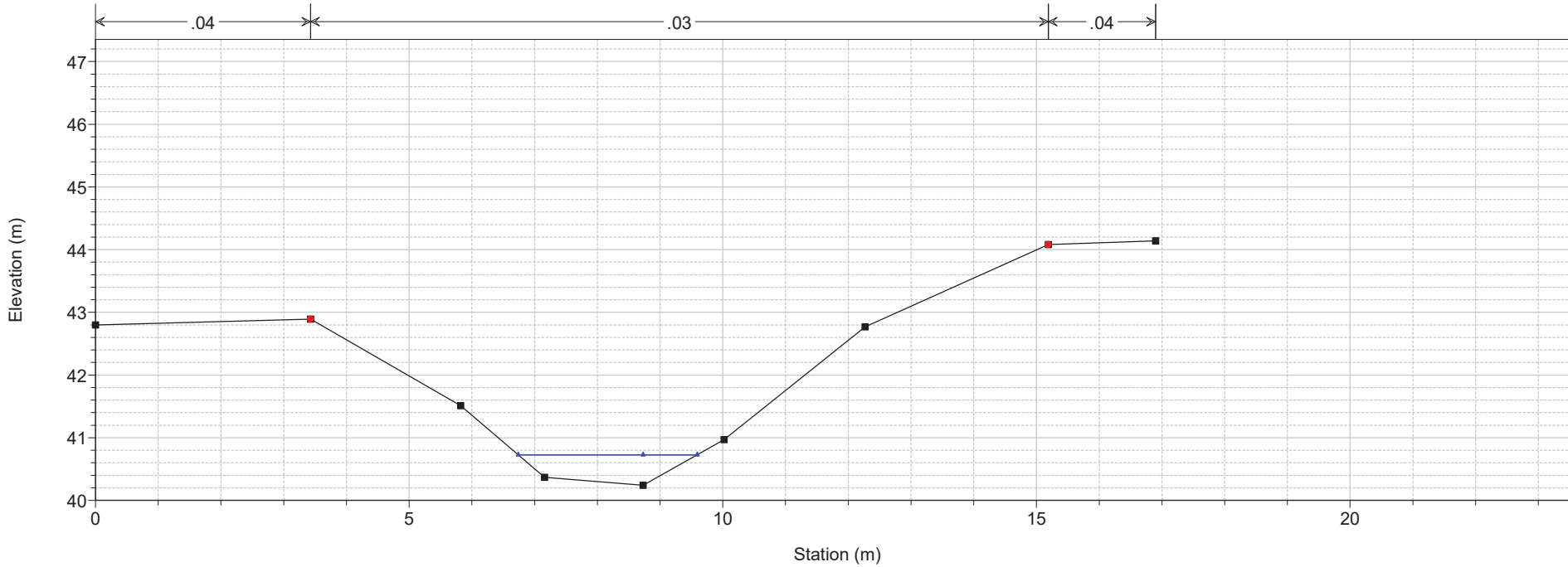

1) A TR30 2) ATR200
 River = Fosso dei Morti Reach = Morti RS = 31 Sez. 10

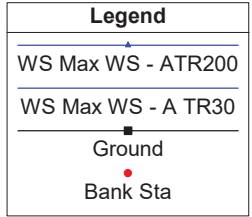
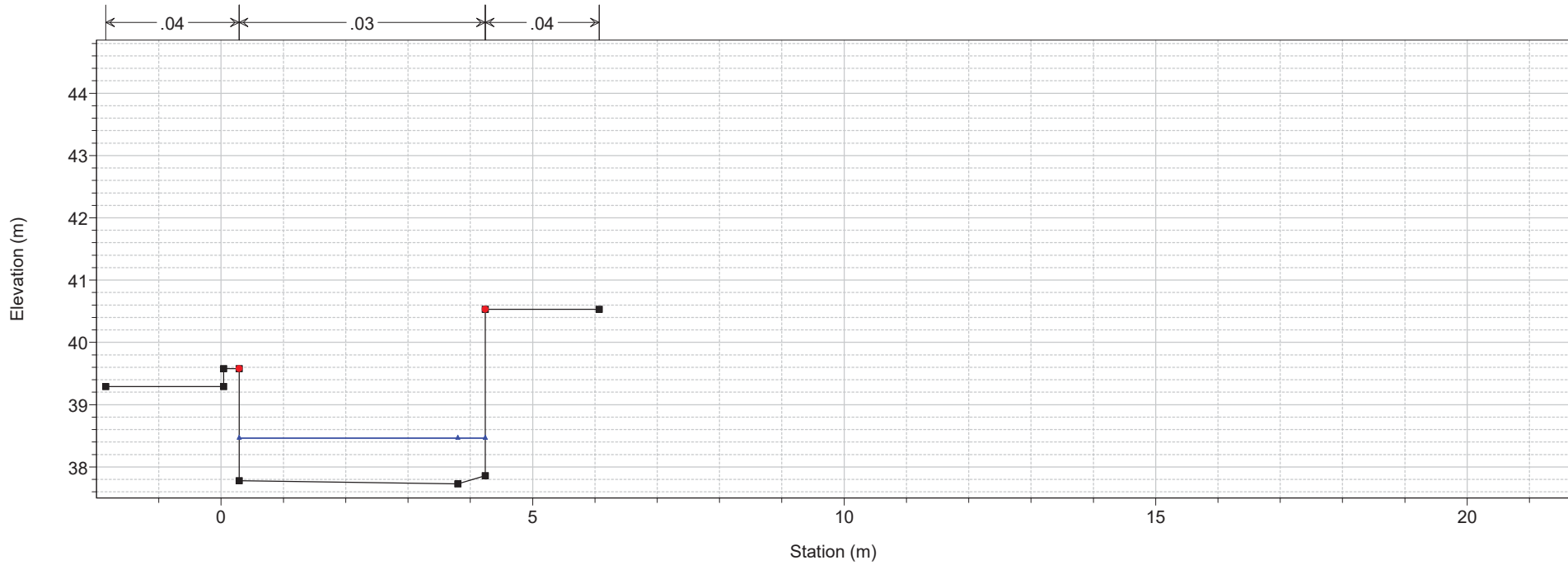

1) A TR30 2) ATR200
 River = Fosso dei Morti Reach = Morti RS = 30.9

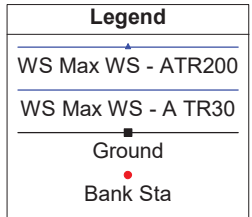
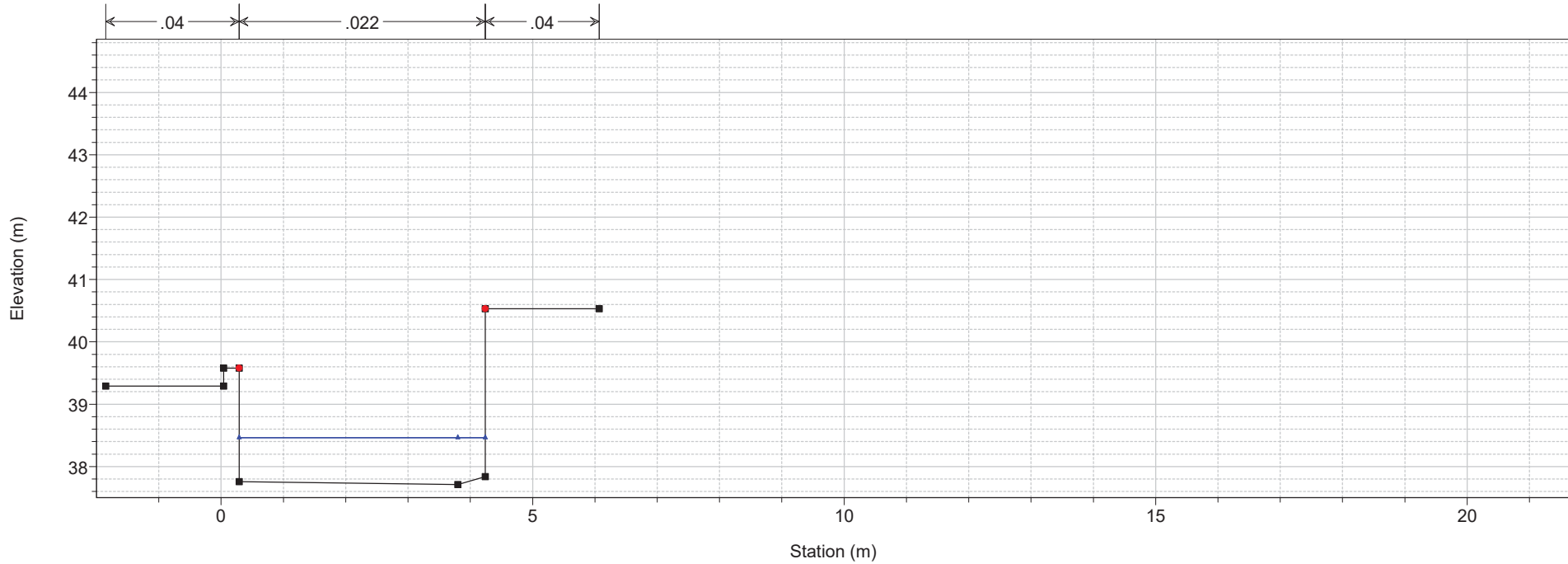

1) A TR30 2) ATR200

River = Fosso dei Morti Reach = Morti RS = 30.5 BR

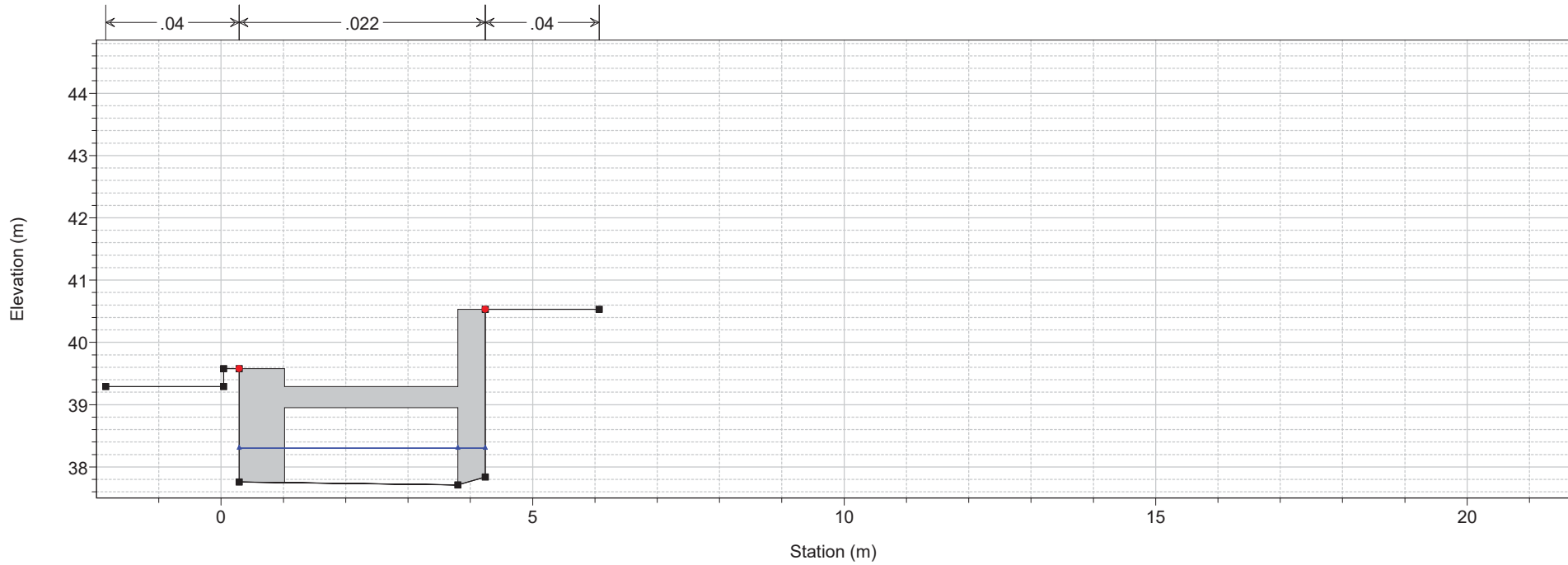

1) A TR30 2) ATR200

River = Fosso dei Morti Reach = Morti RS = 30.5 BR

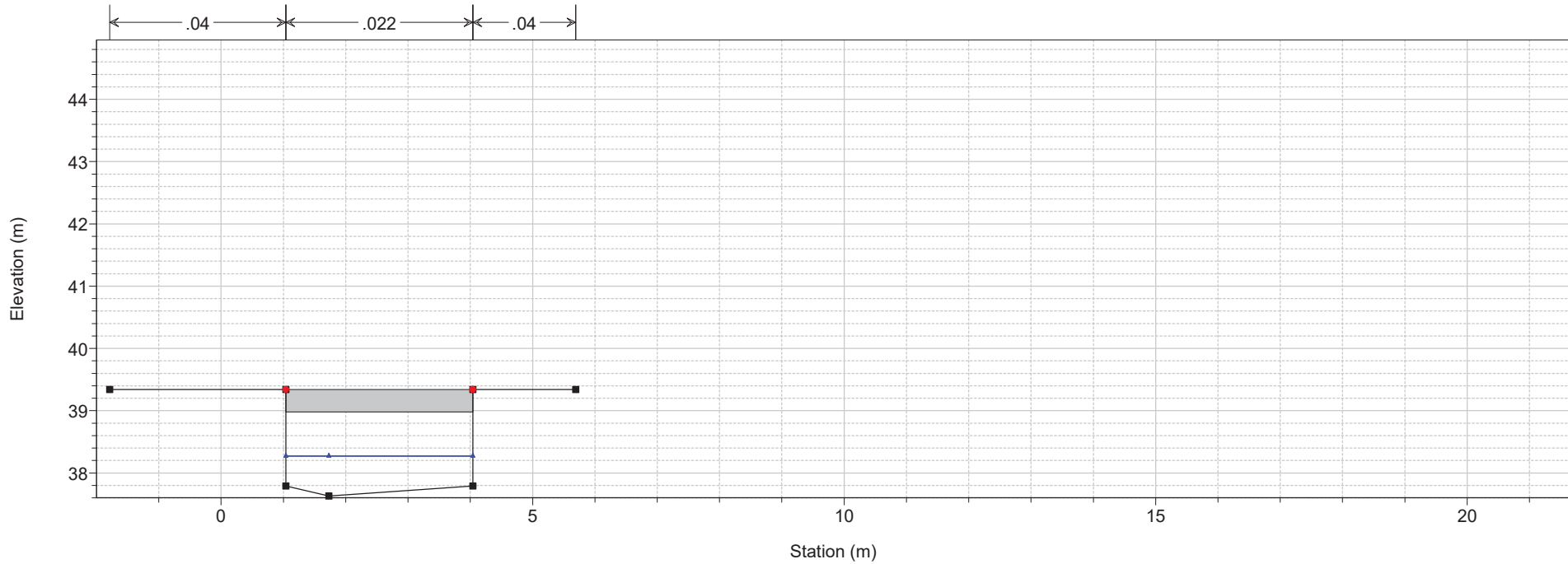

1) A TR30 2) ATR200
River = Fosso dei Morti Reach = Morti RS = 30.1 Sez. 11

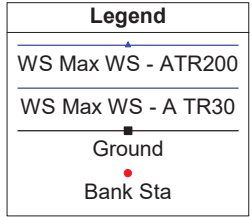
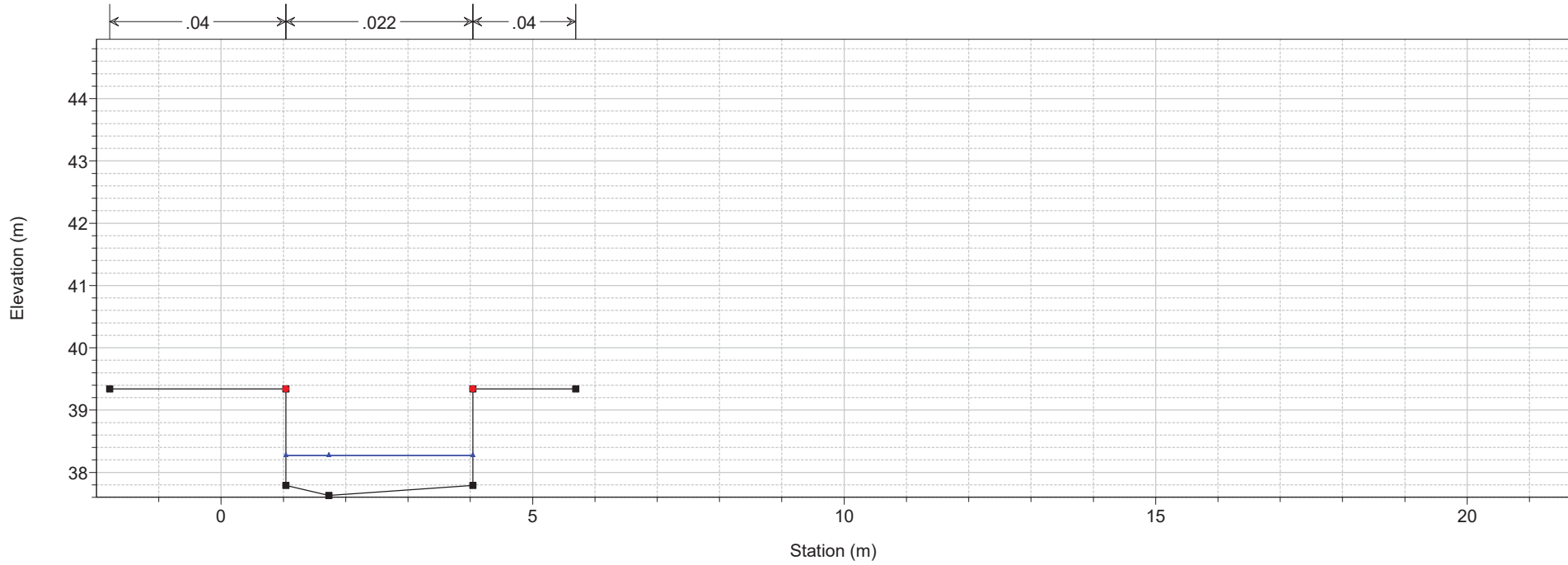

1) A TR30 2) ATR200
River = Fosso dei Morti Reach = Morti RS = 30 Sez. 11

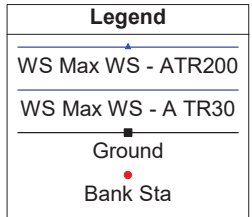
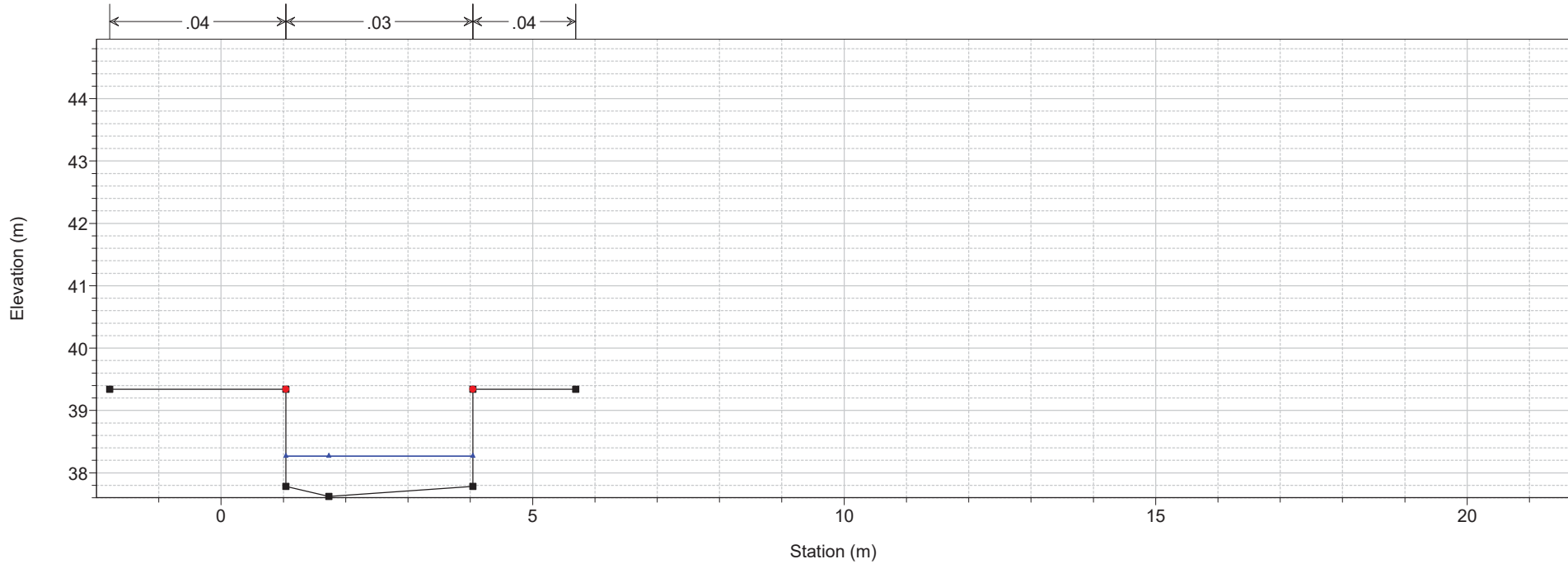

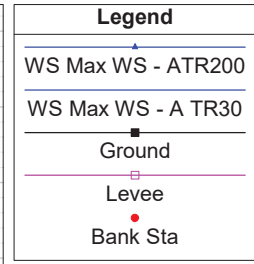
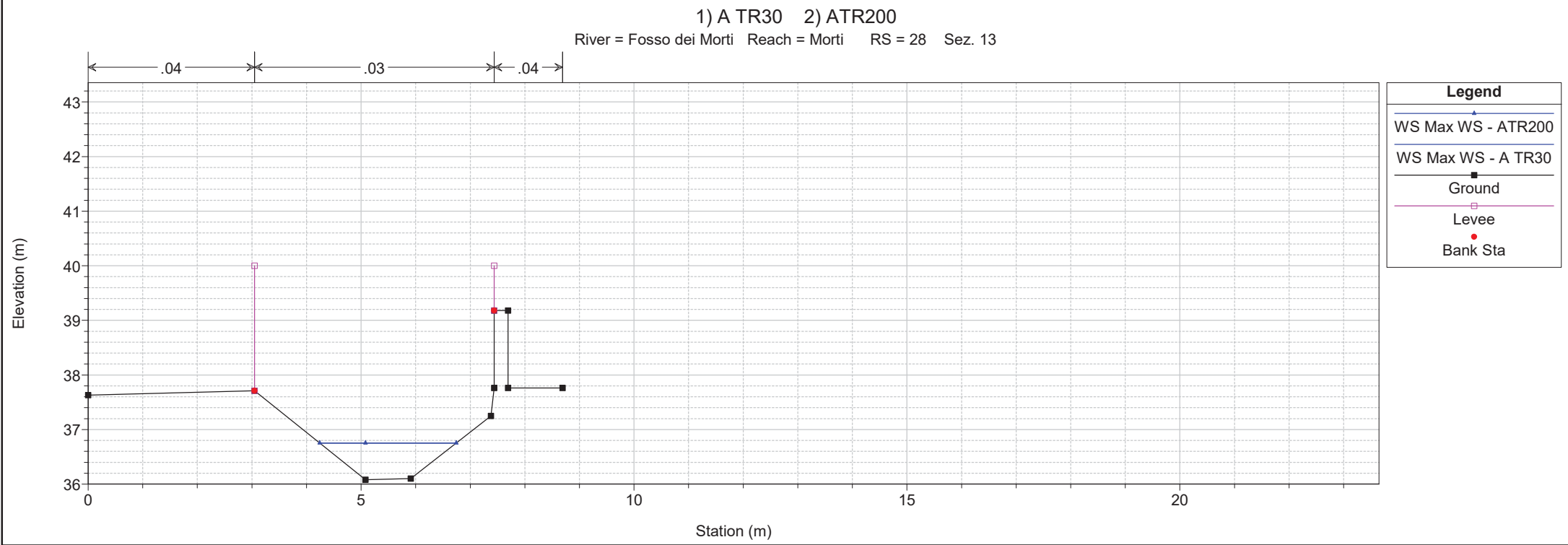
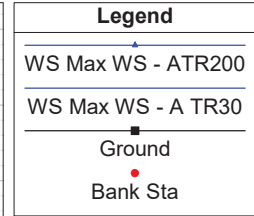
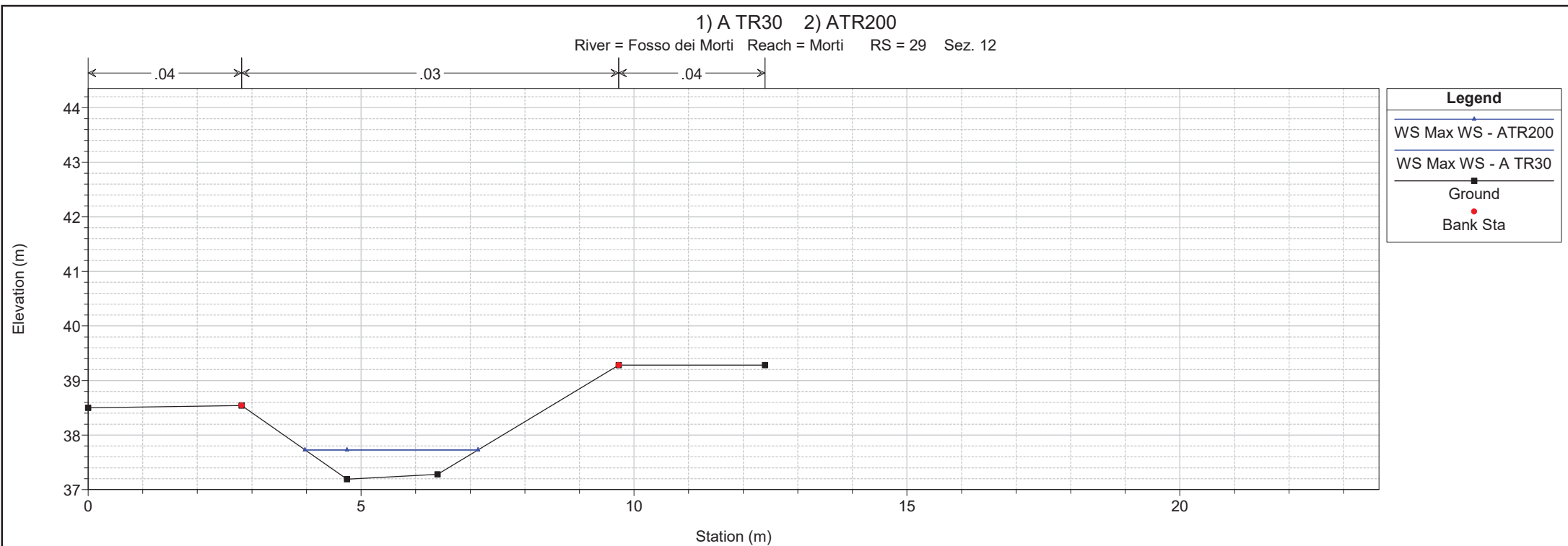

1) A TR30 2) ATR200
 River = Fosso dei Morti Reach = Morti RS = 27 Sez. 14

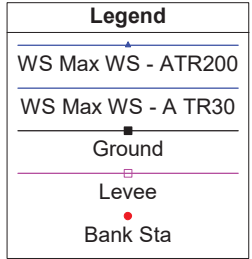
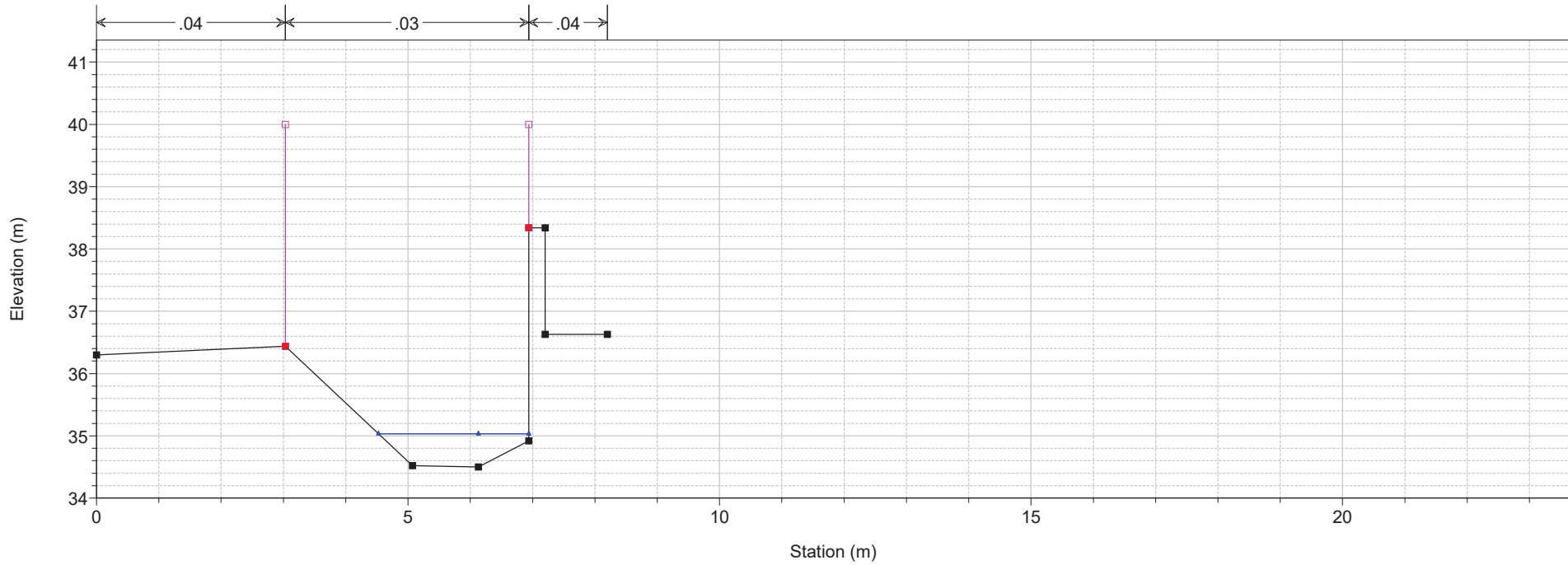

1) A TR30 2) ATR200
 River = Fosso dei Morti Reach = Morti RS = 26 Sez. 15

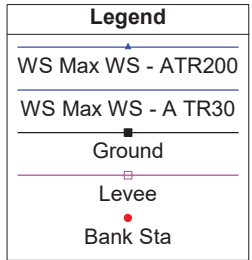
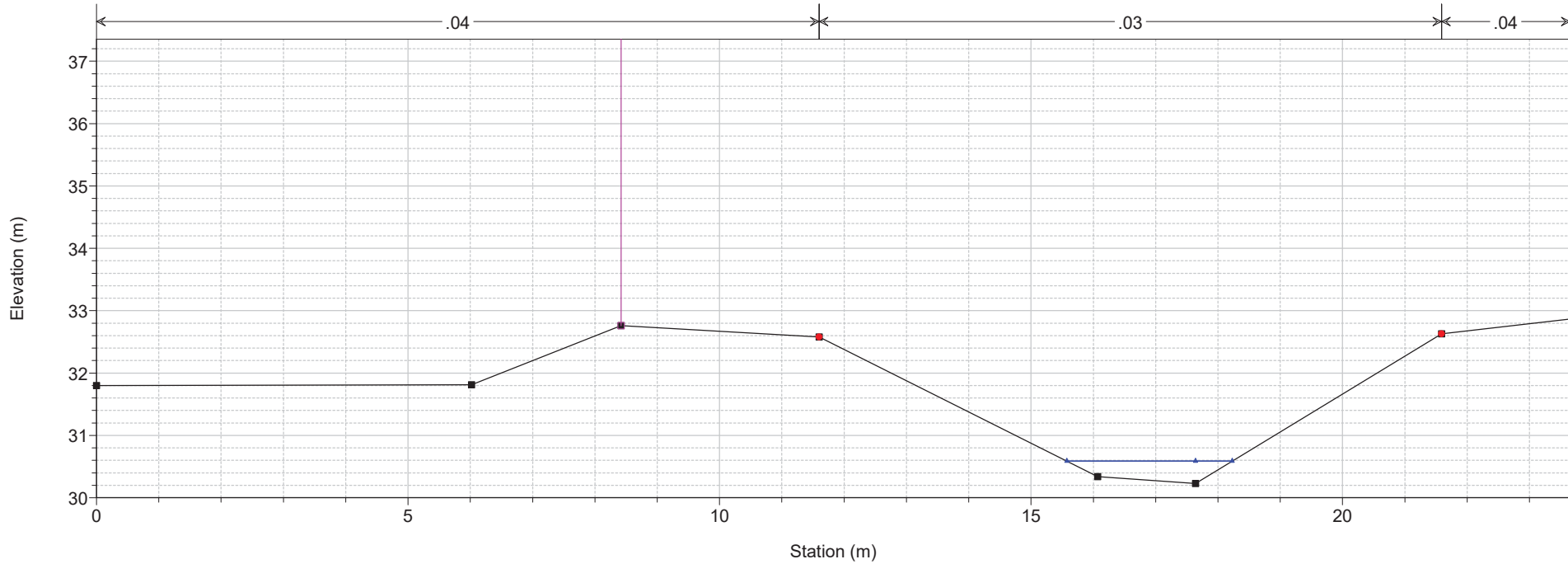

1) A TR30 2) ATR200
 River = Fosso dei Morti Reach = Morti RS = 25.5 Sez. esp1

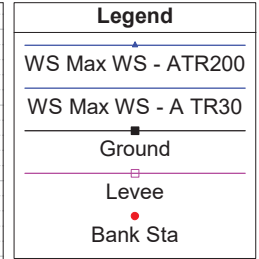
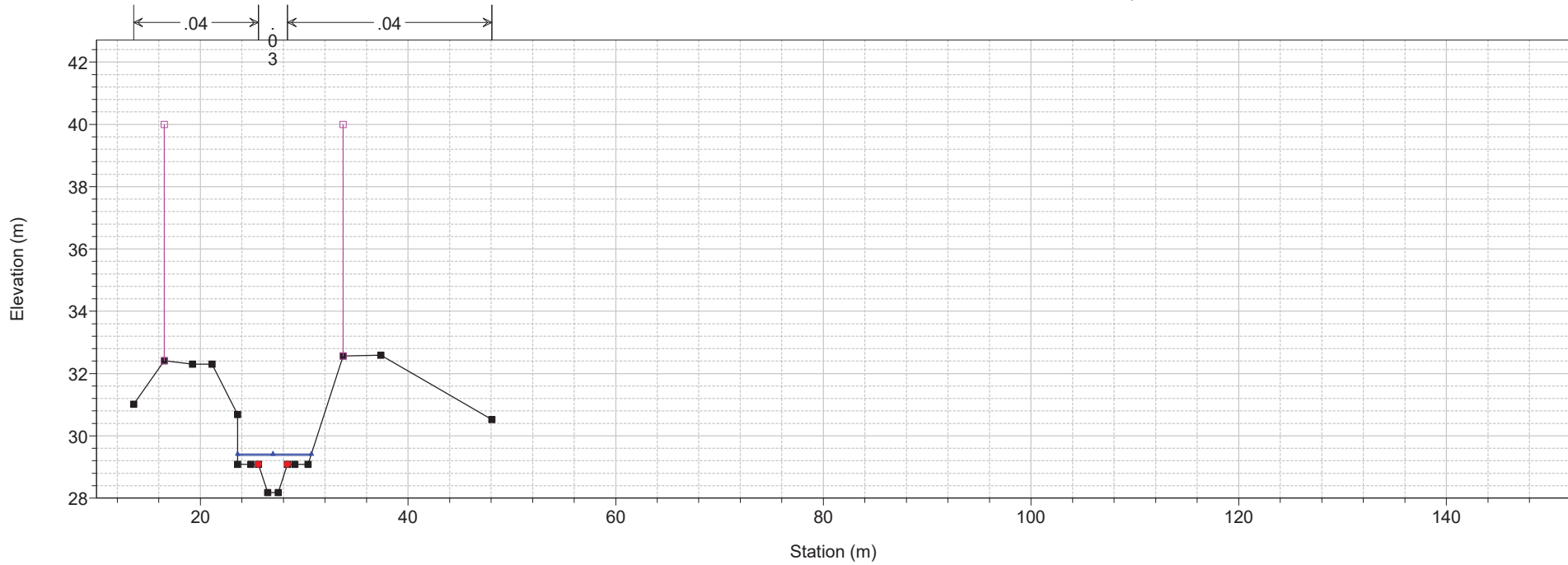

1) A TR30 2) ATR200
 River = Fosso dei Morti Reach = Morti RS = 25 Sez. esp1

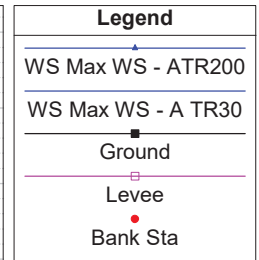
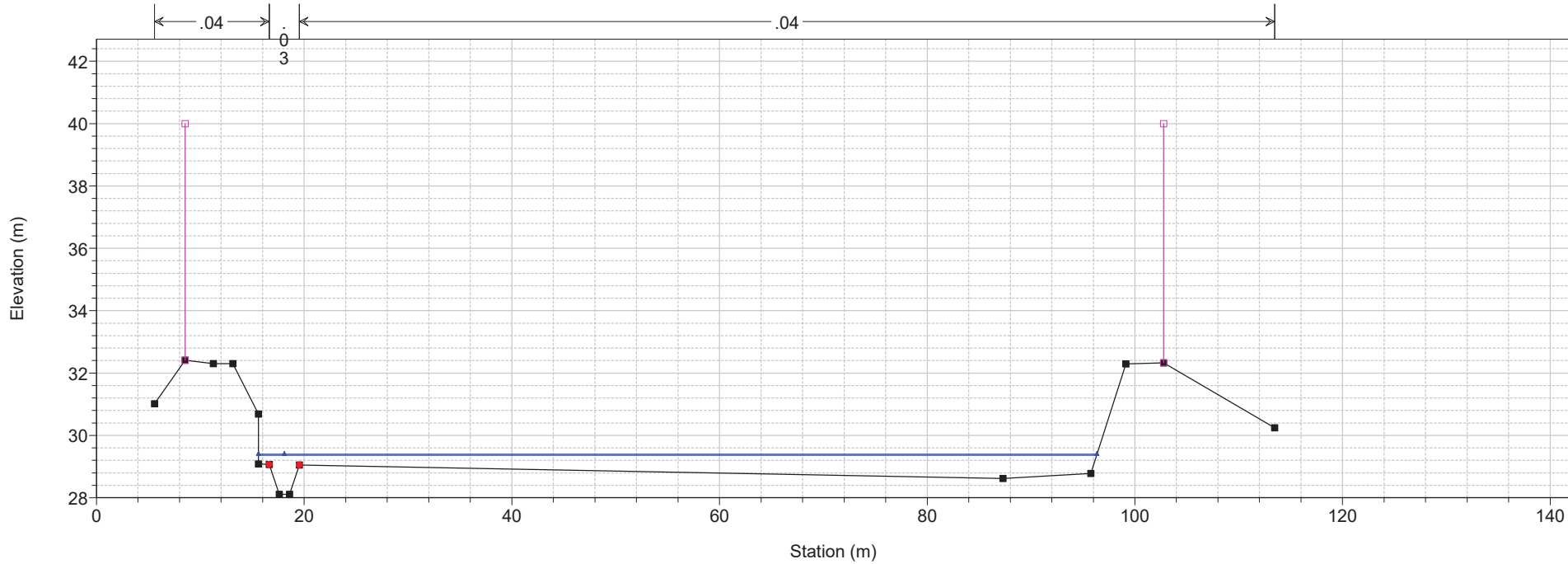

1 cm Horiz. = 6 m 1 cm Vert. = 2 m

1) A TR30 2) ATR200
 River = Fosso dei Morti Reach = Morti RS = 24 Sez. esp2

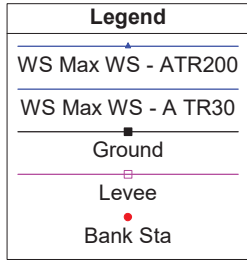
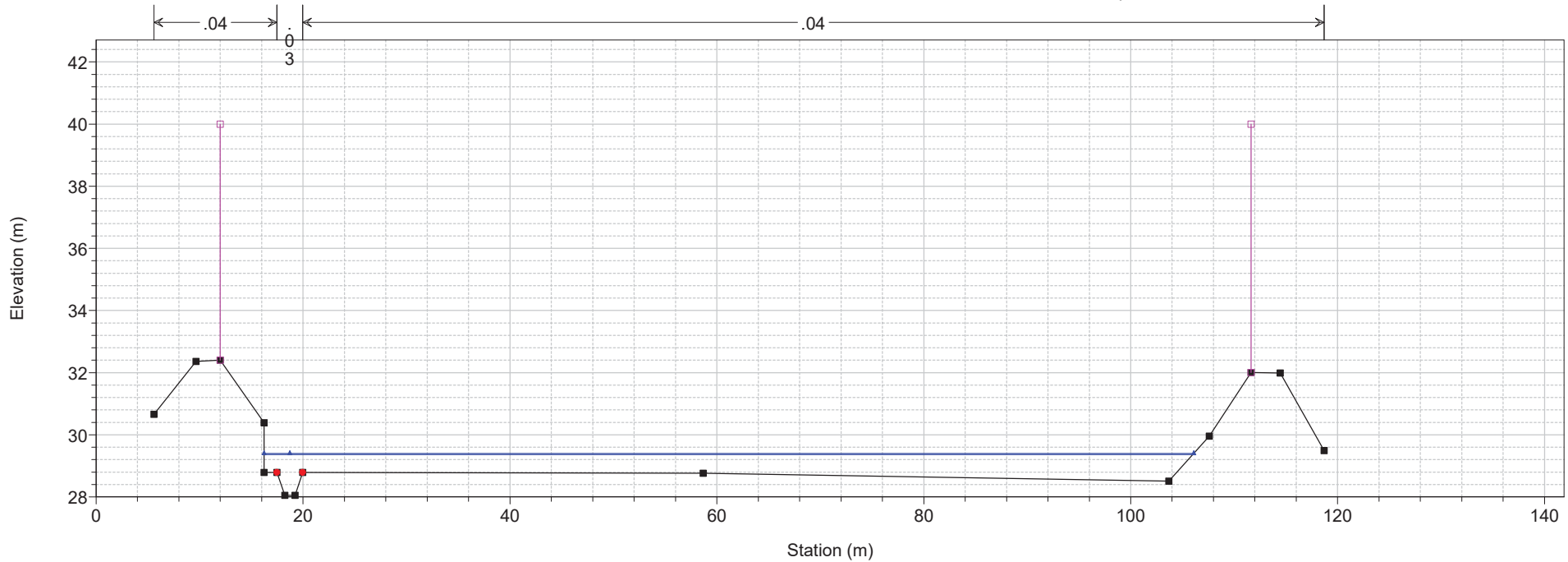

1) A TR30 2) ATR200
 River = Fosso dei Morti Reach = Morti RS = 23 Sez. esp3

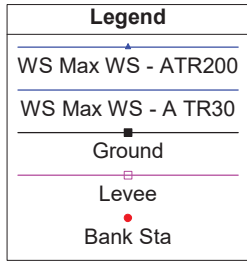
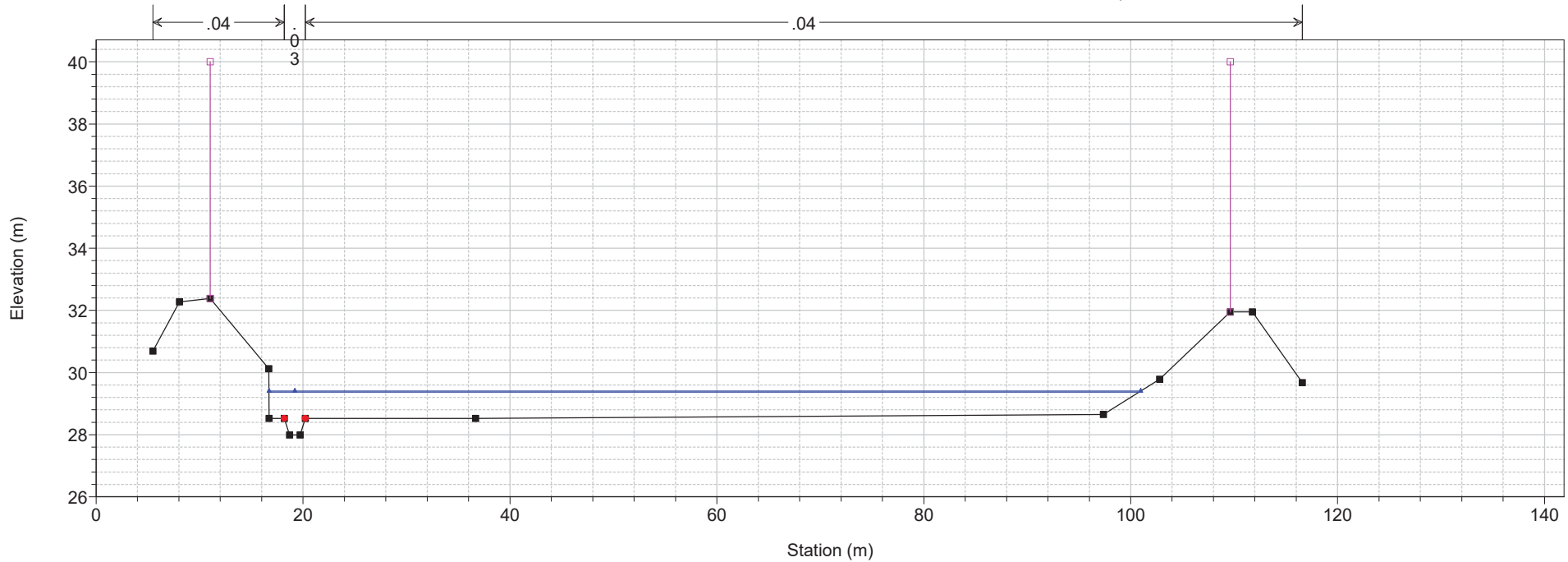

1 cm Horiz. = 6 m 1 cm Vert. = 2 m

1) A TR30 2) ATR200
 River = Fosso dei Morti Reach = Morti RS = 22 Sez. 16_1

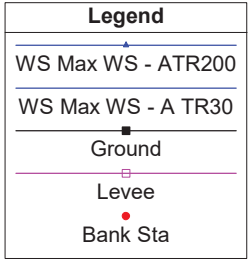
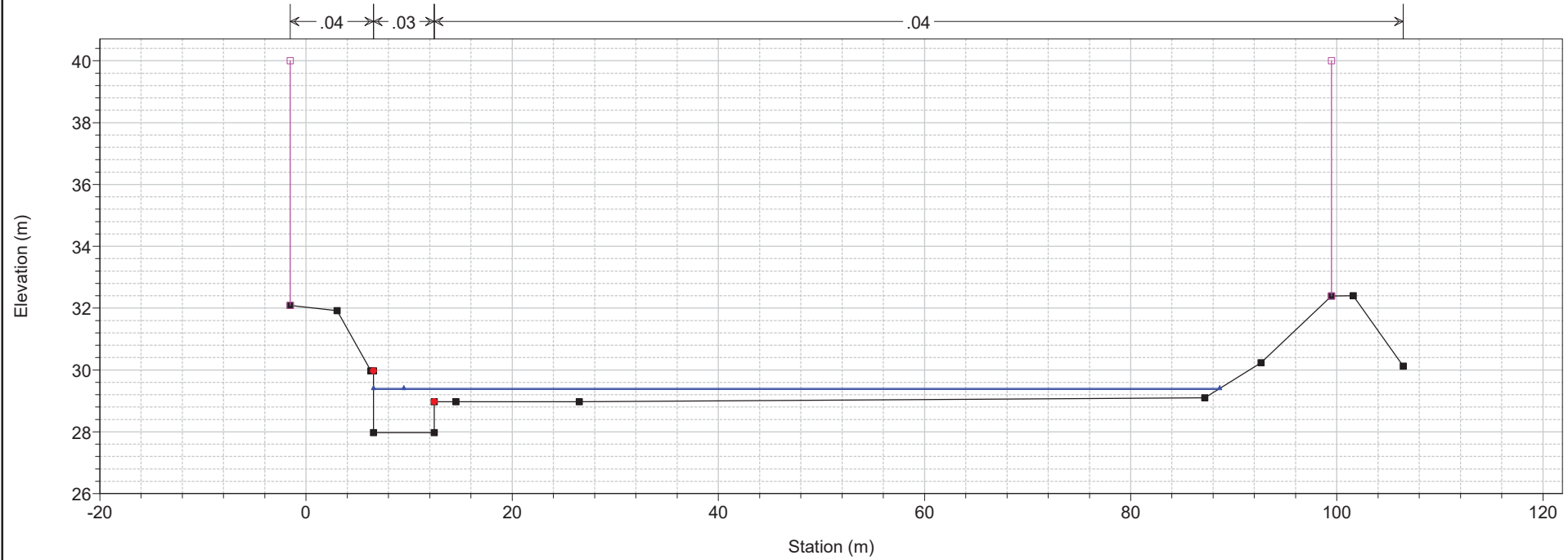

1) A TR30 2) ATR200
 River = Fosso dei Morti Reach = Morti RS = 21.5 Culv

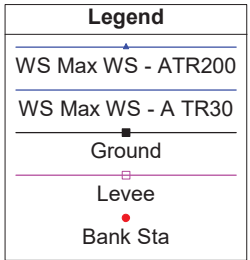
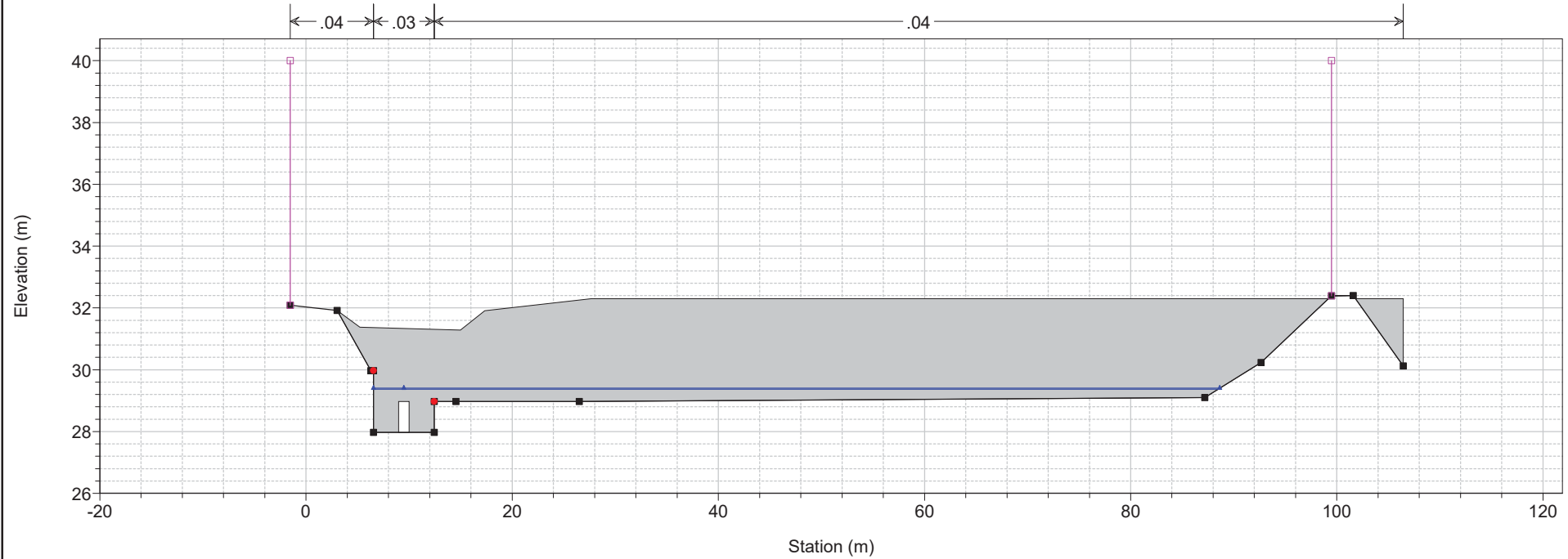

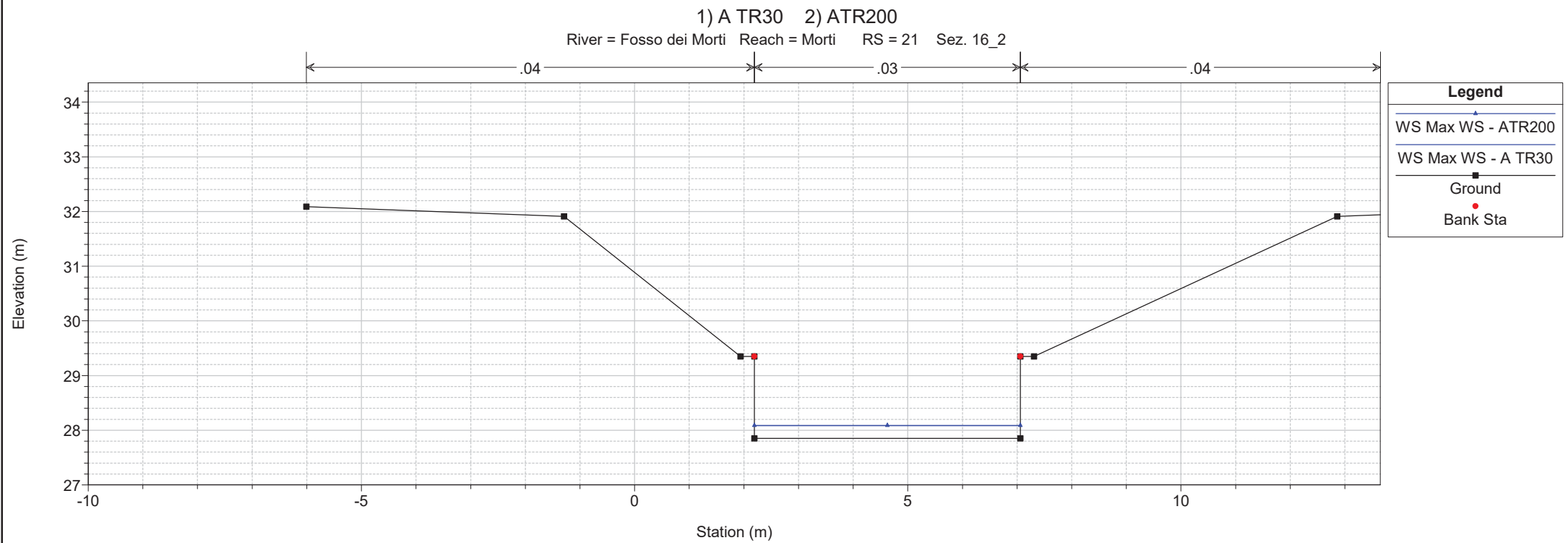
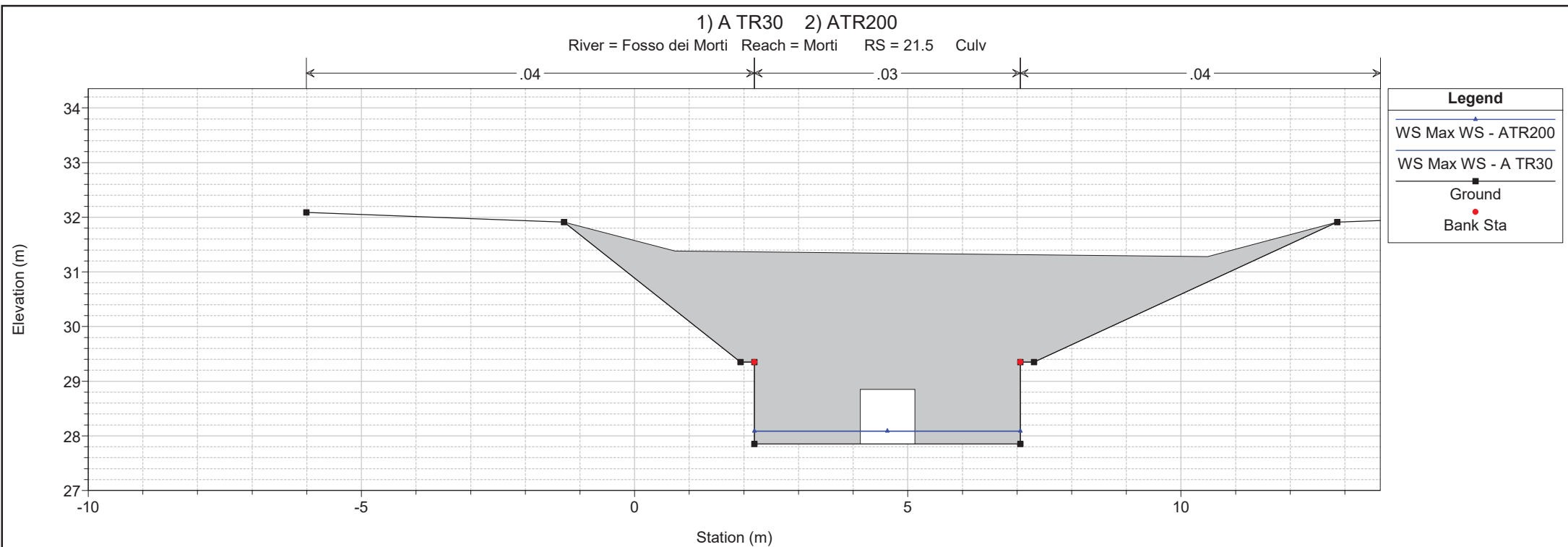

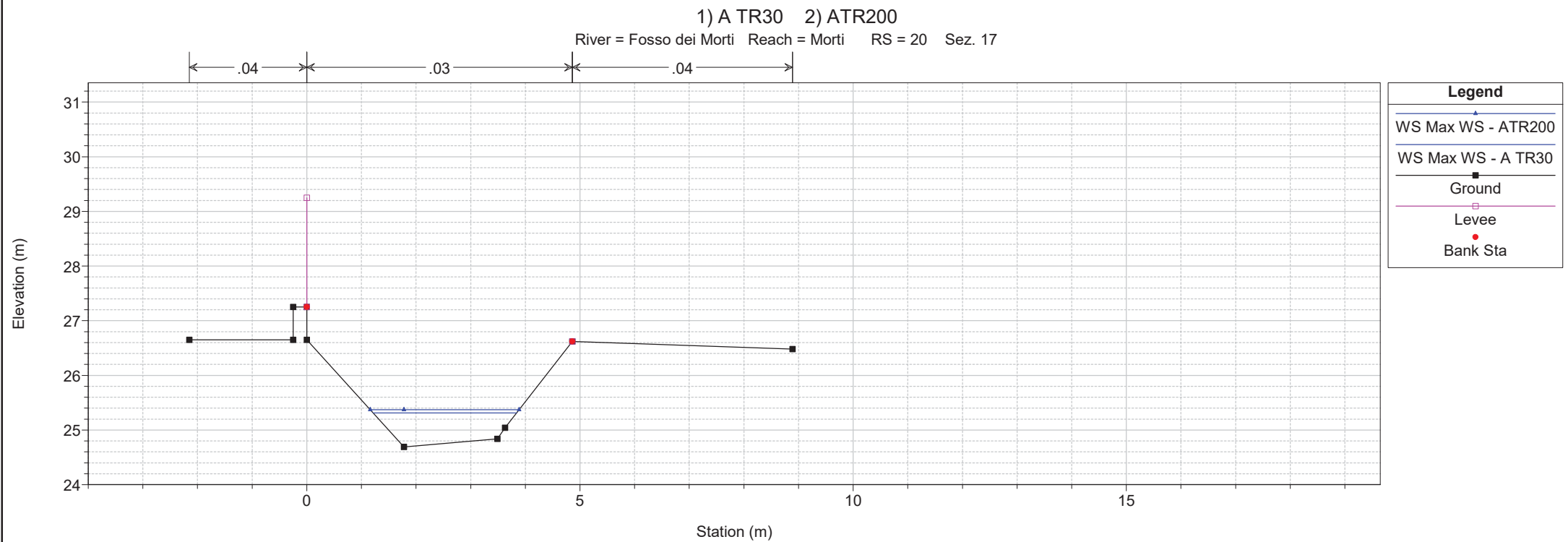
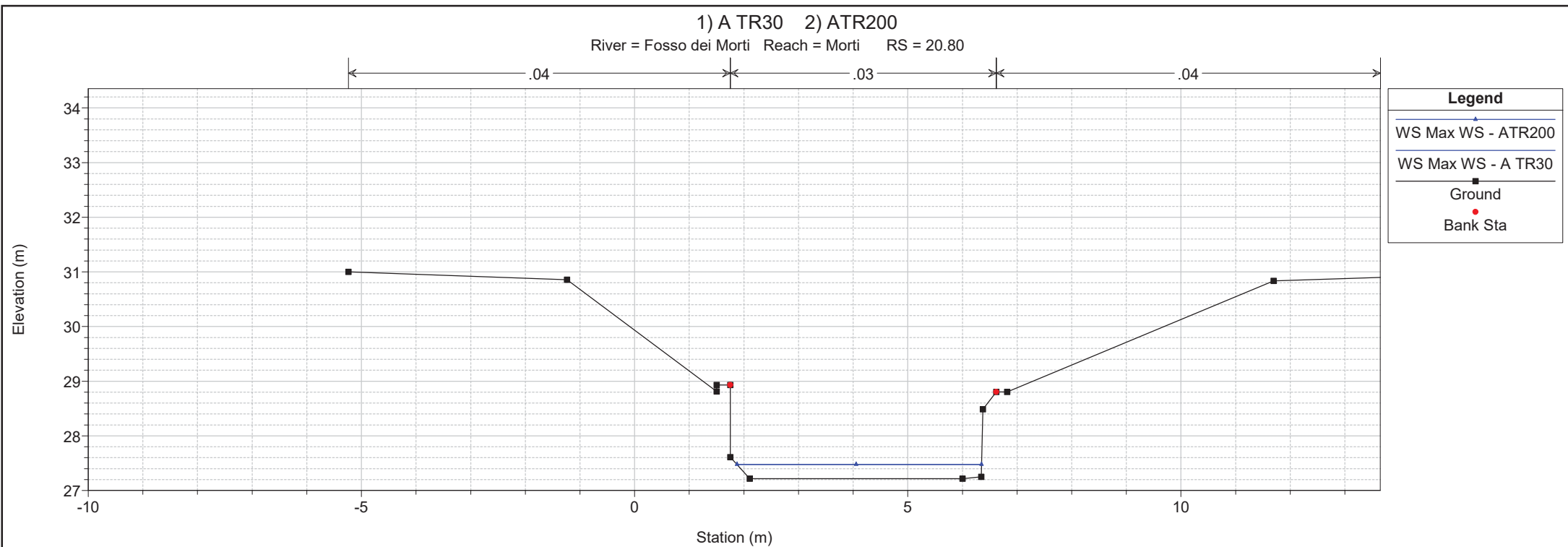

1) A TR30 2) ATR200

River = Fosso dei Morti Reach = Morti RS = 19.9

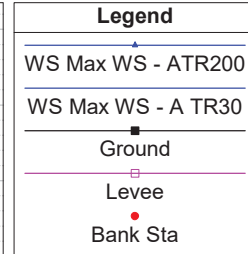
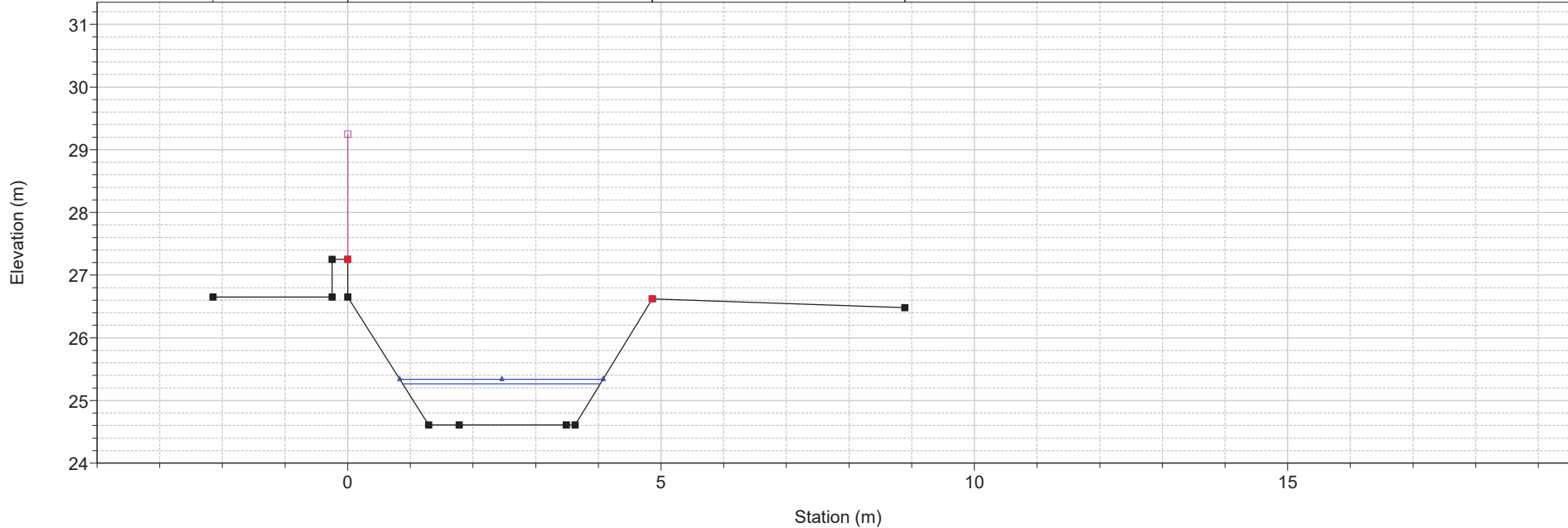

1) A TR30 2) ATR200

River = Fosso dei Morti Reach = Morti RS = 19.5 BR

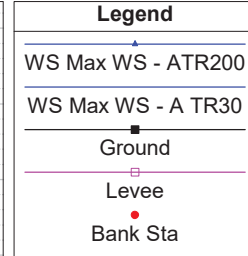
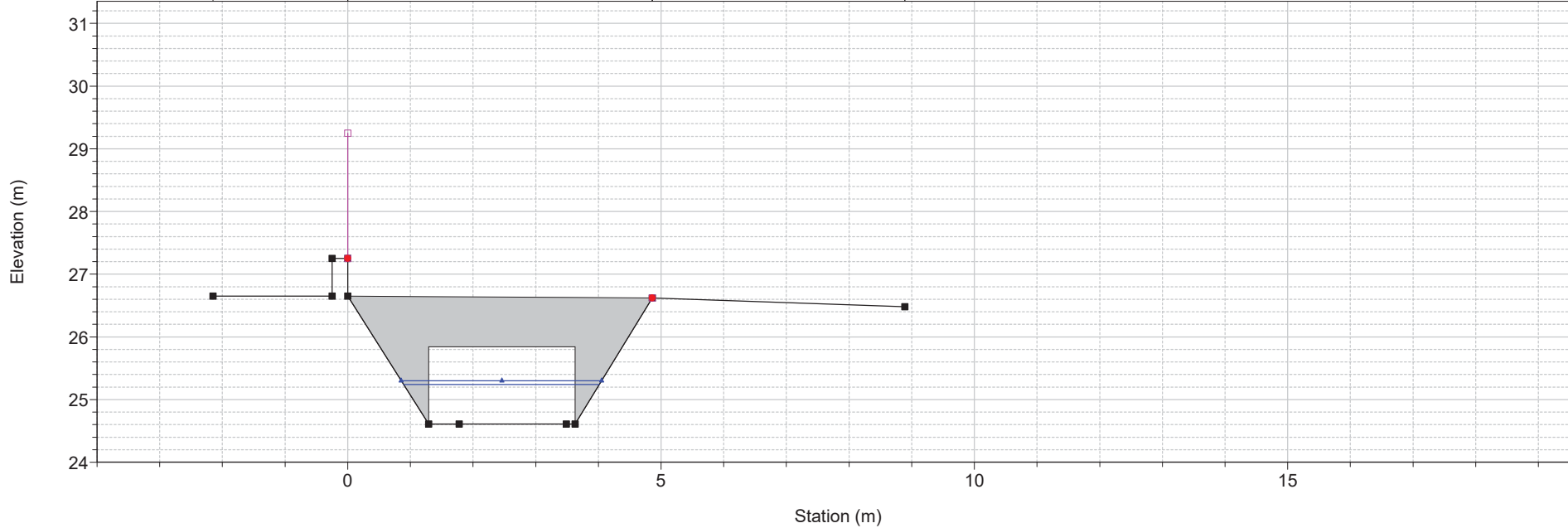

1) A TR30 2) ATR200

River = Fosso dei Morti Reach = Morti RS = 19.5 BR

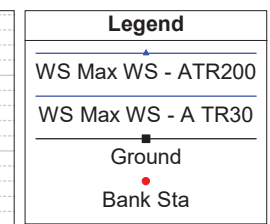
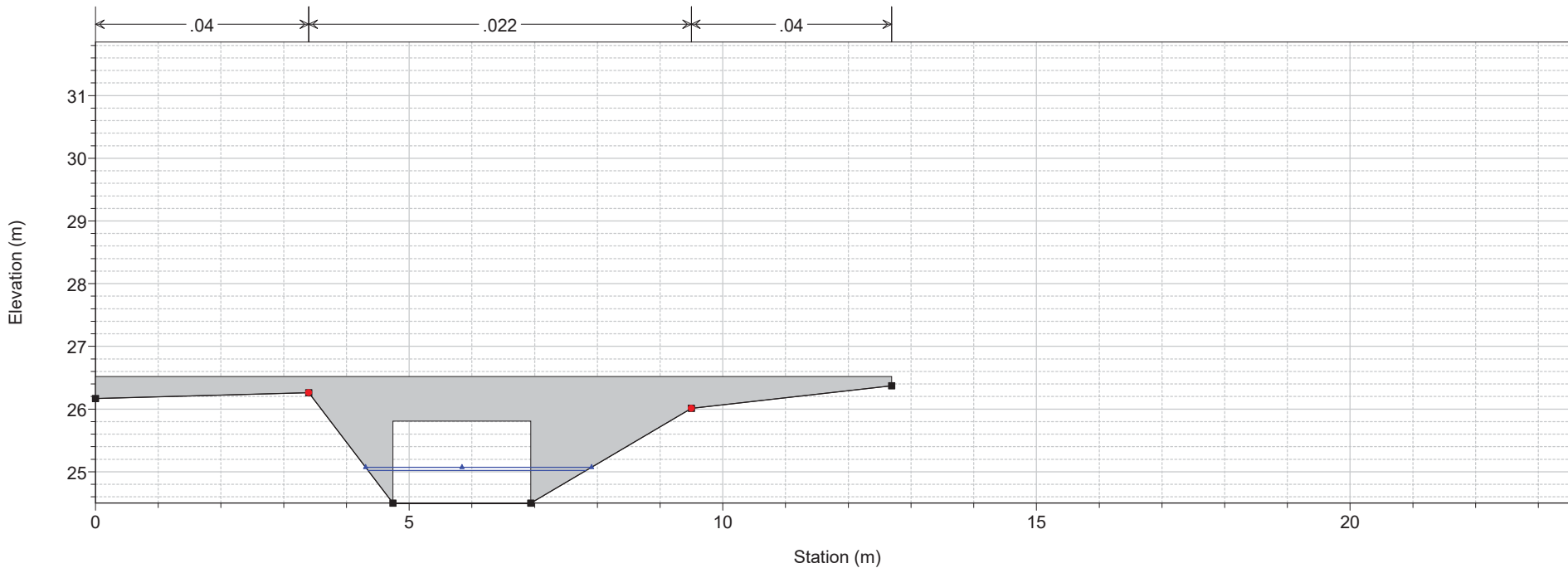

1) A TR30 2) ATR200

River = Fosso dei Morti Reach = Morti RS = 19.1 Sez. 18

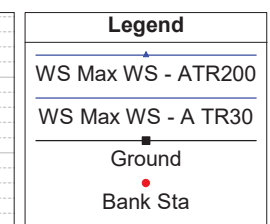
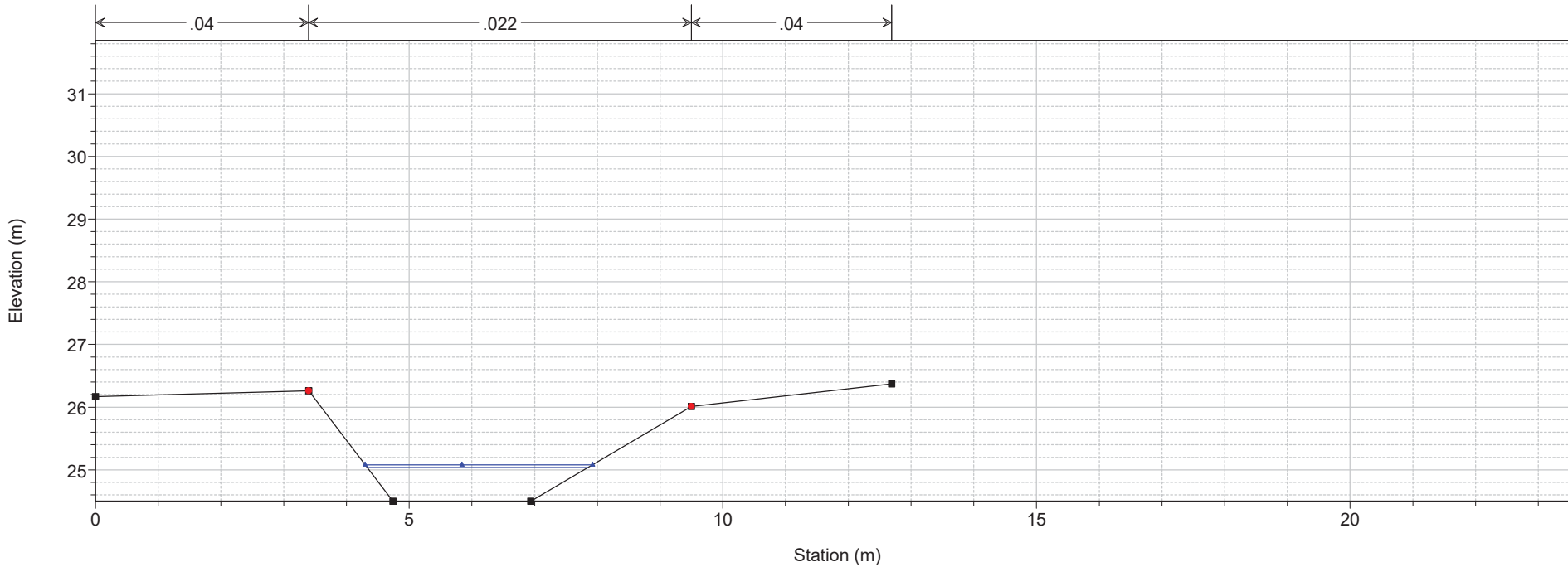

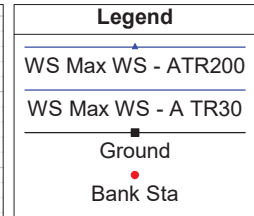
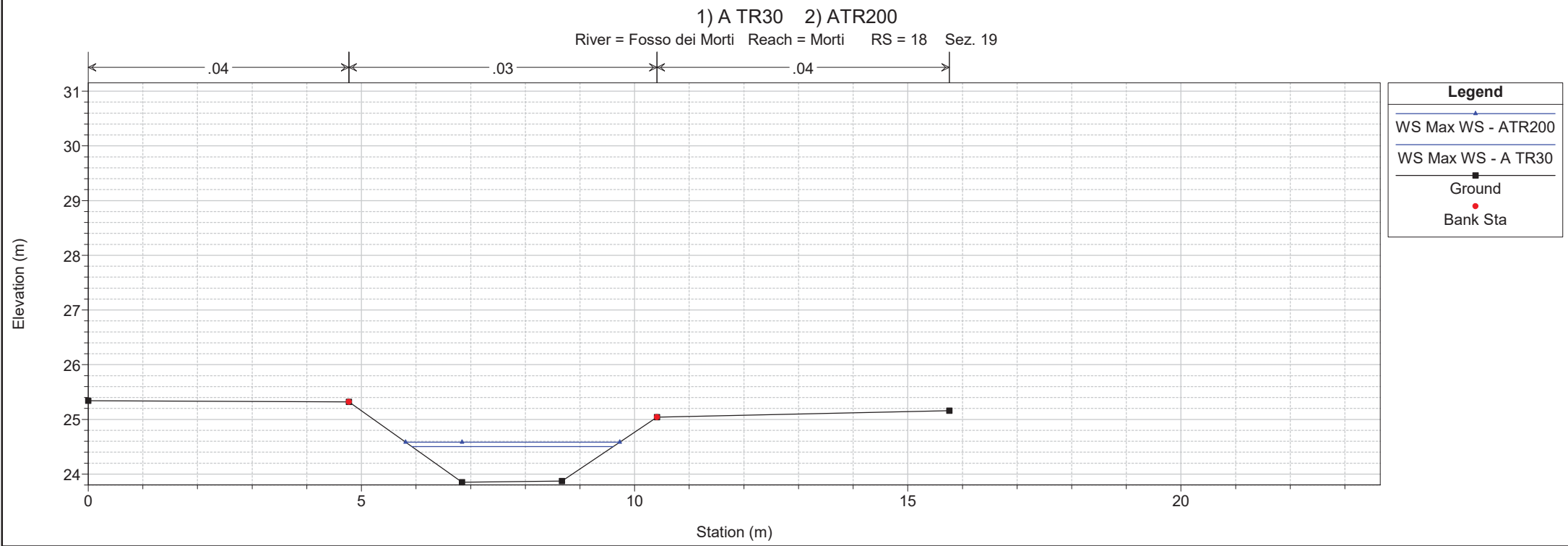
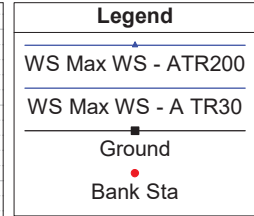
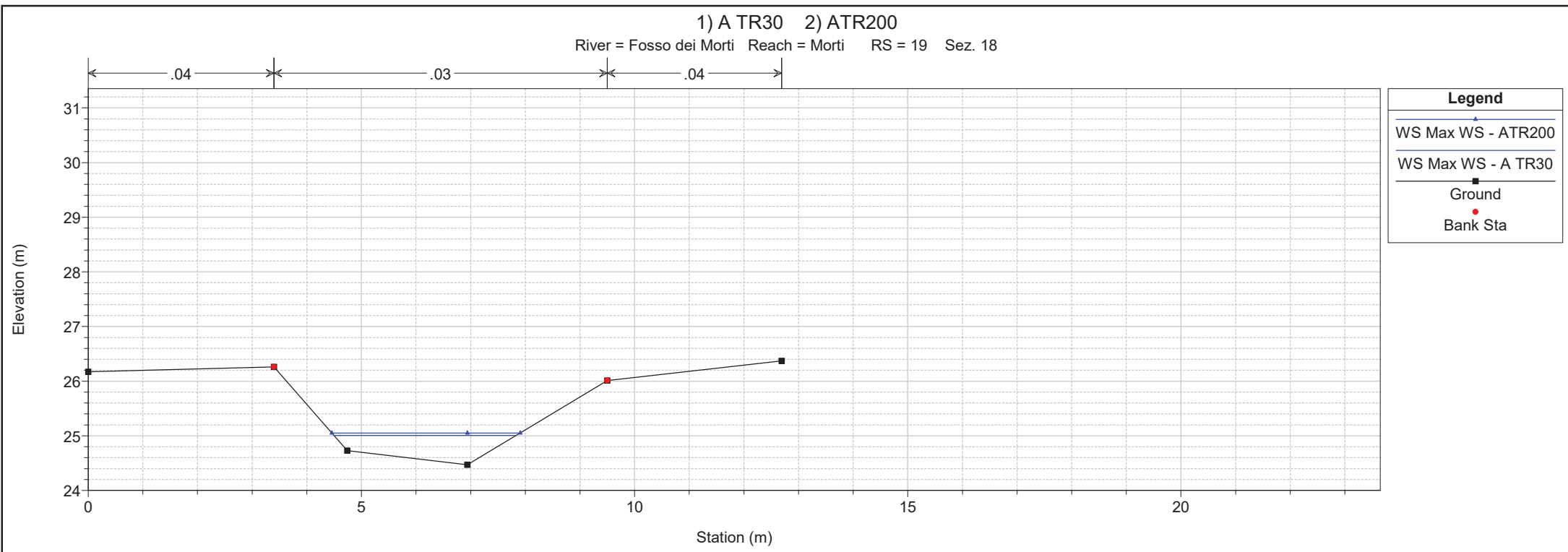

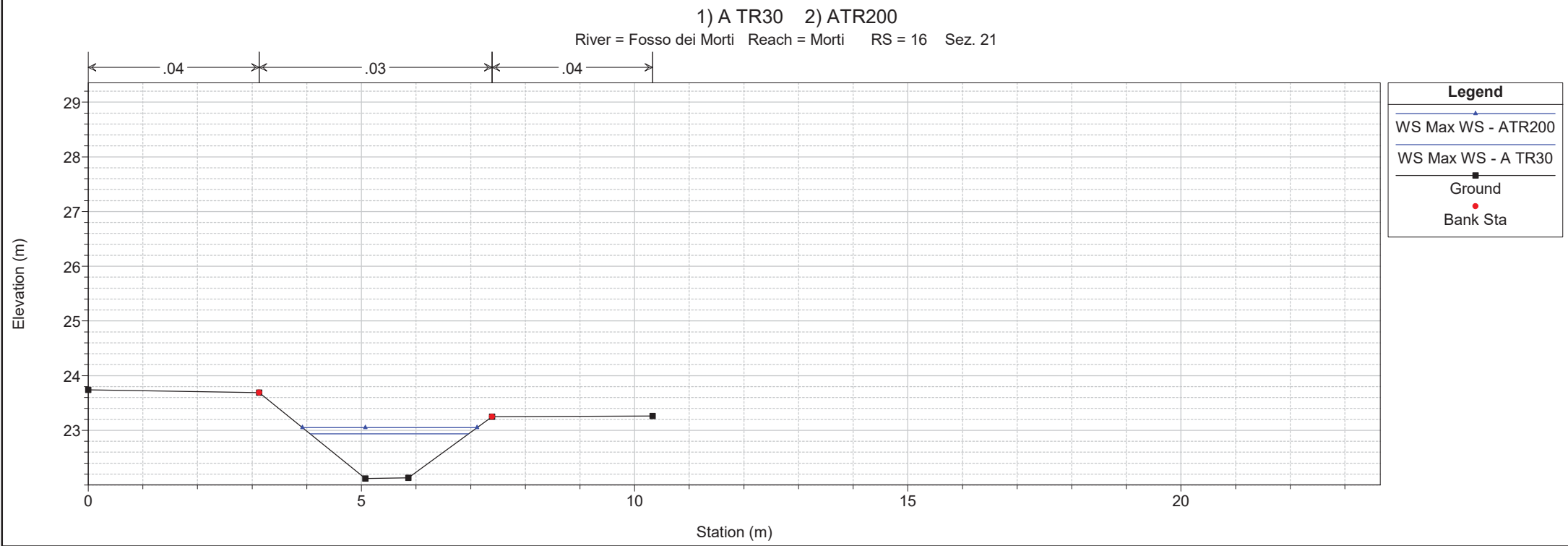
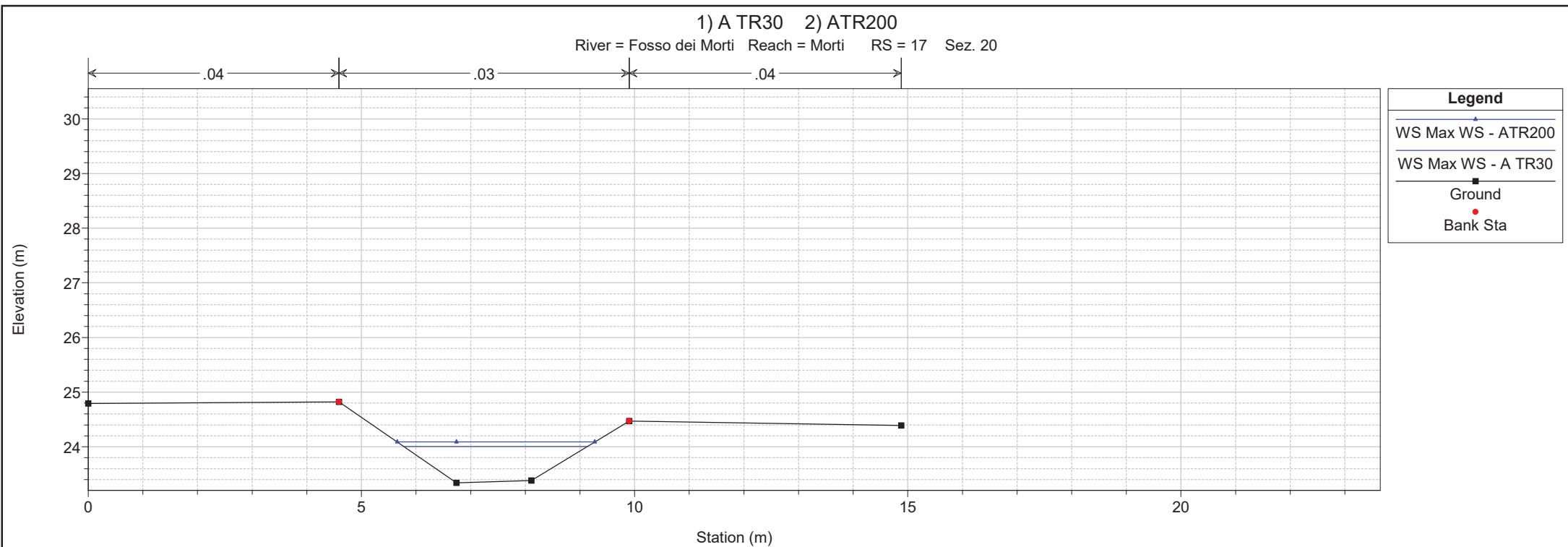

1) A TR30 2) ATR200
 River = Fosso dei Morti Reach = Morti RS = 15.1 Sez. 22

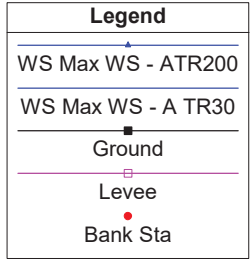
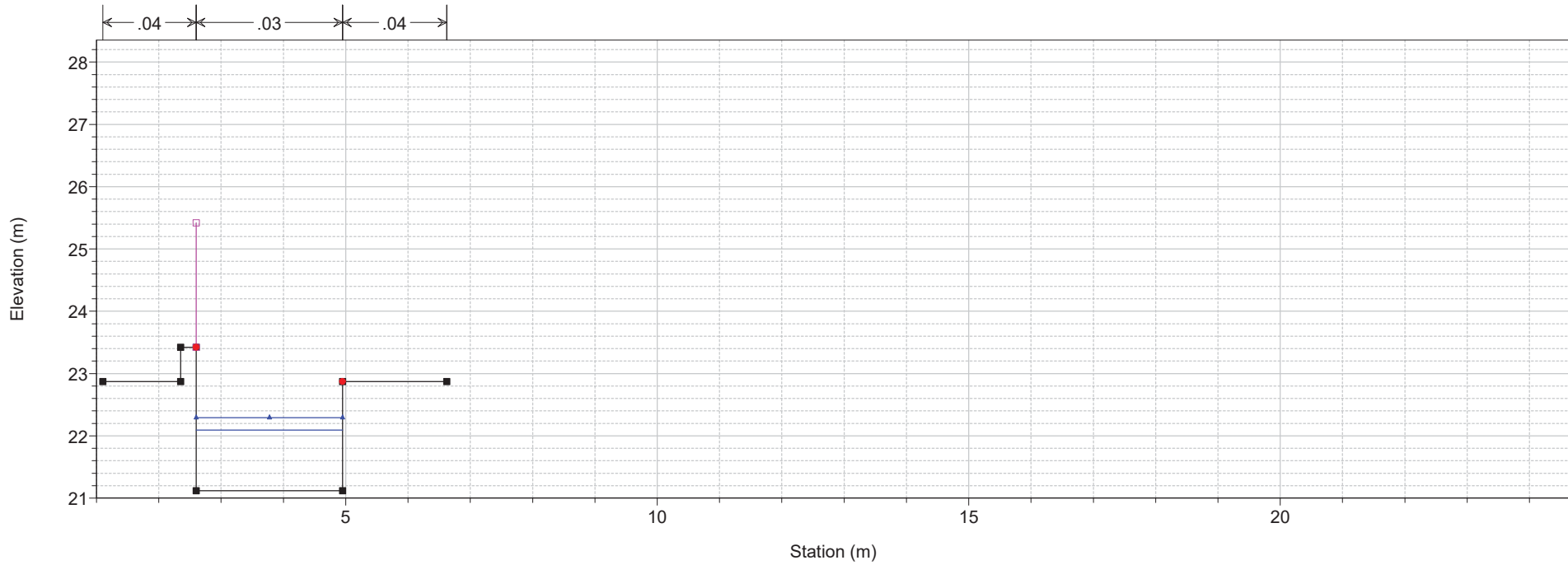

1) A TR30 2) ATR200
 River = Fosso dei Morti Reach = Morti RS = 15 Sez. 22

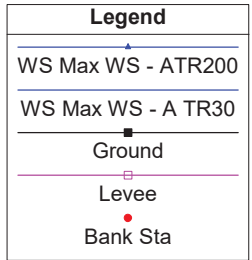
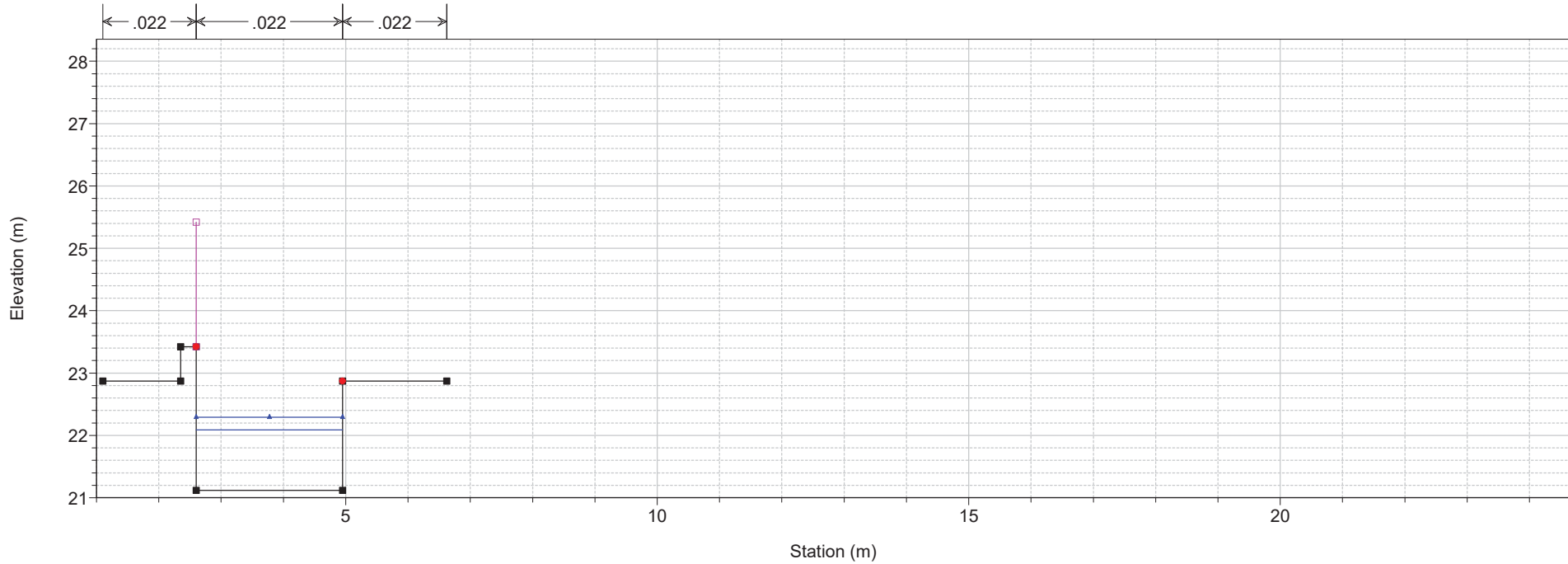

1) A TR30 2) ATR200
 River = Fosso dei Morti Reach = Morti RS = 14.5 BR

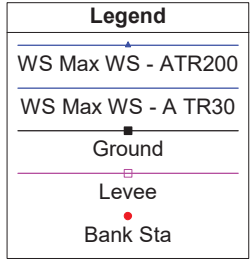
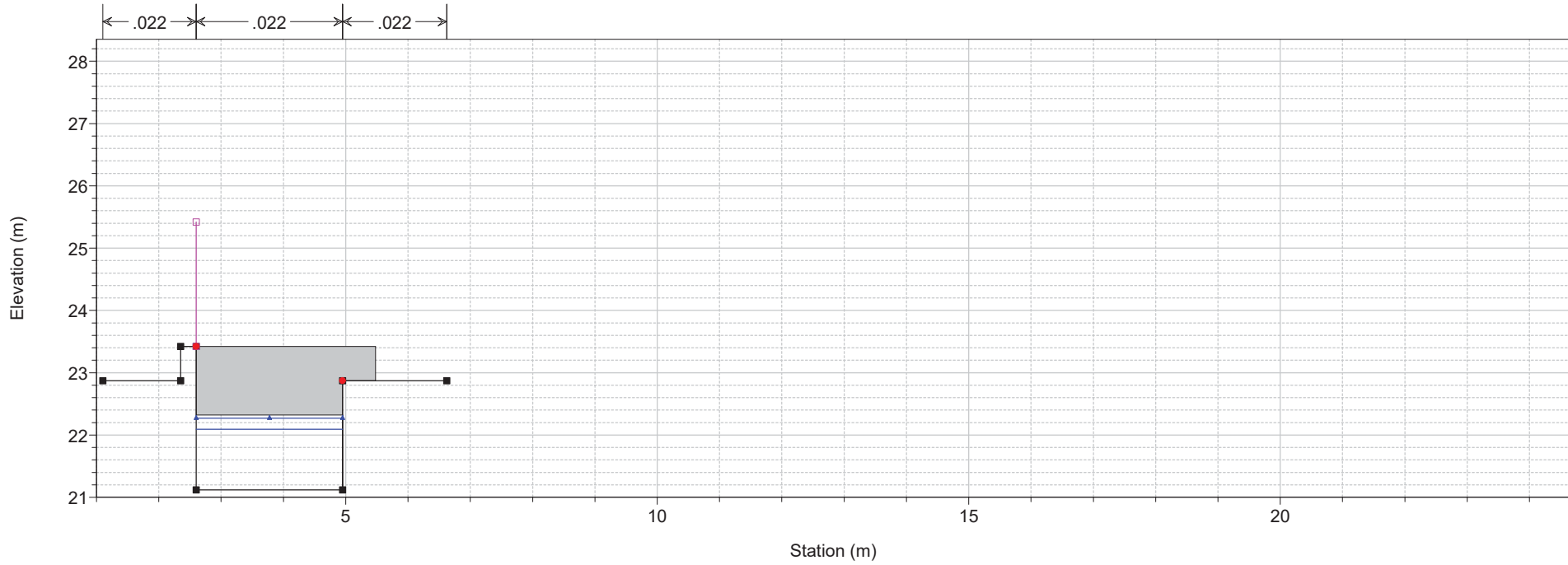

1) A TR30 2) ATR200
 River = Fosso dei Morti Reach = Morti RS = 14.5 BR

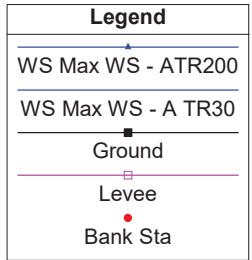
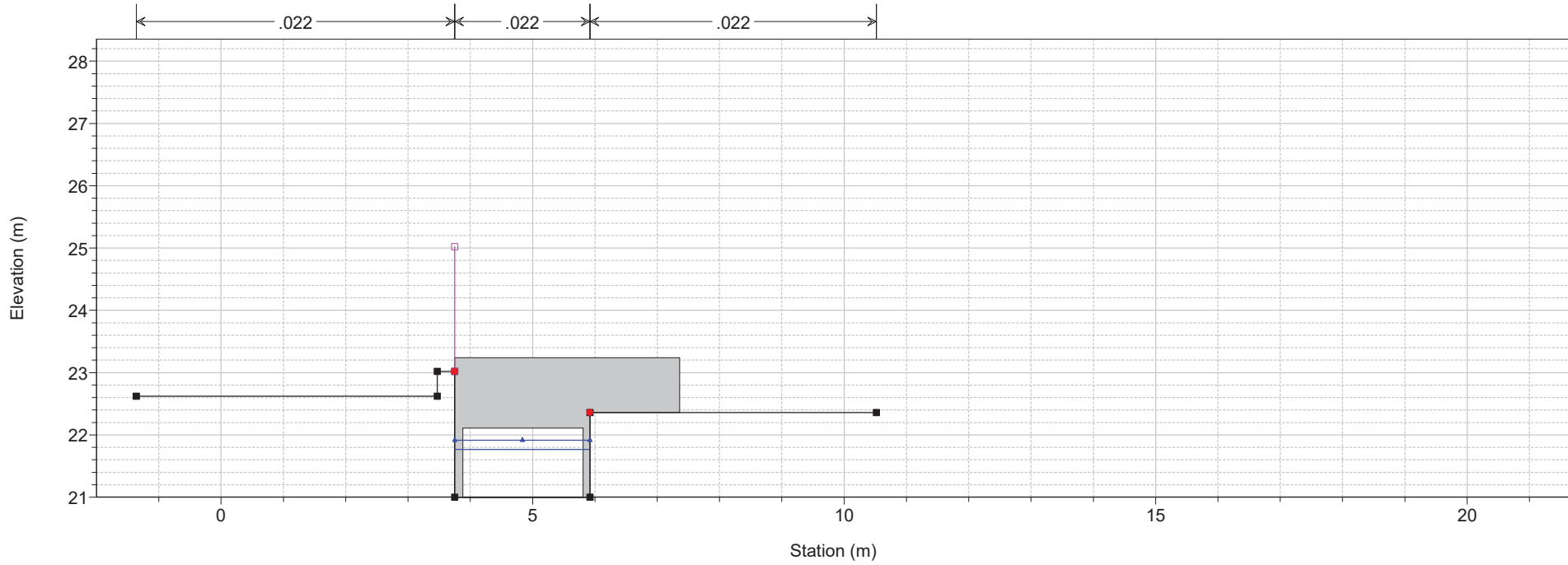

1 cm Horiz. = 1 m 1 cm Vert. = 1 m

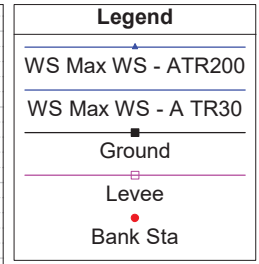
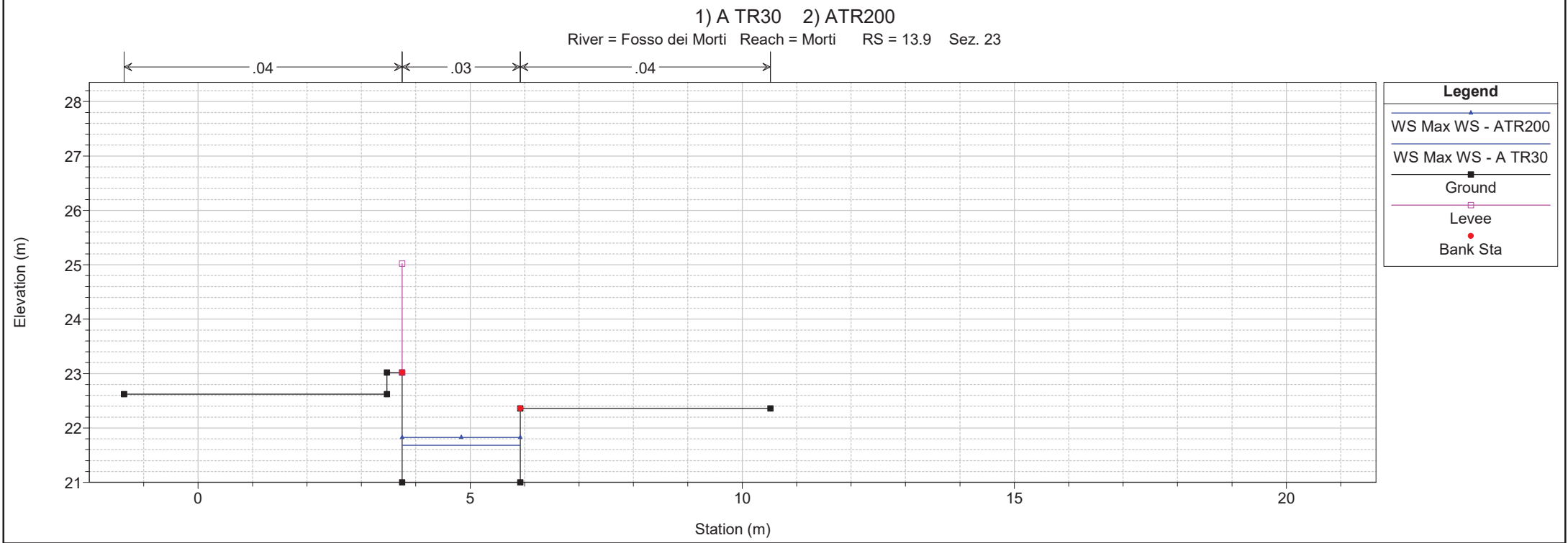
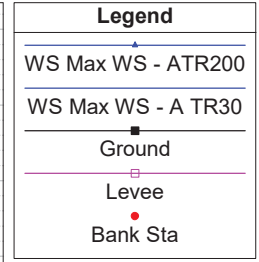
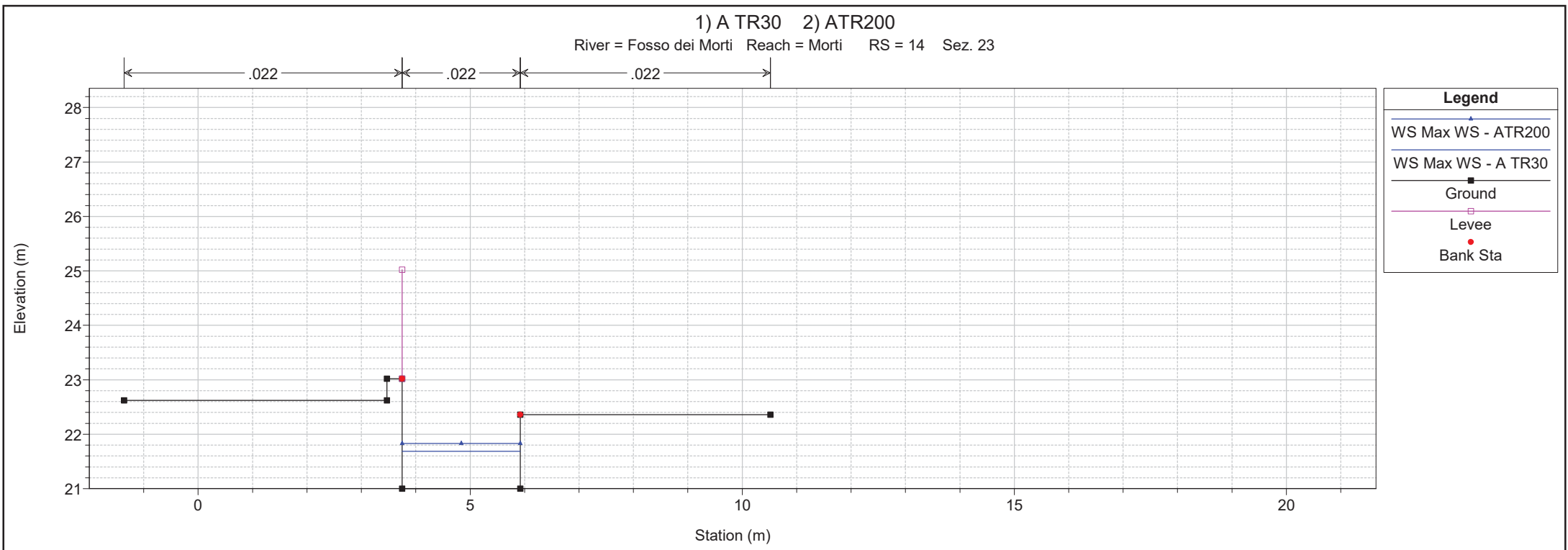

1 cm Horiz. = 1 m 1 cm Vert. = 1 m

1) A TR30 2) ATR200

River = Fosso dei Morti Reach = Morti RS = 13 Sez. 24

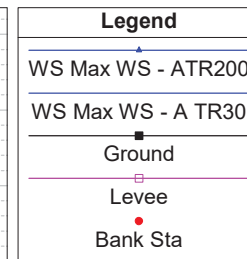
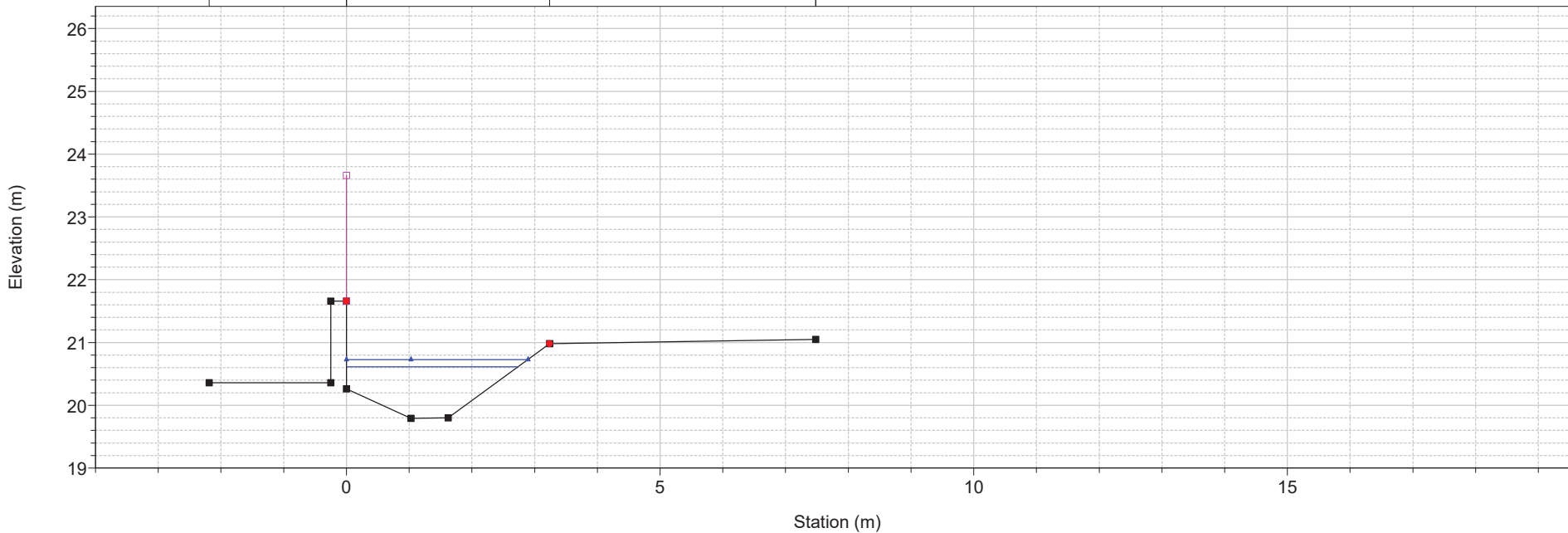

1) A TR30 2) ATR200

River = Fosso dei Morti Reach = Morti RS = 12 Sez. 25

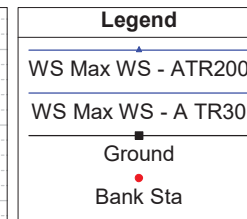
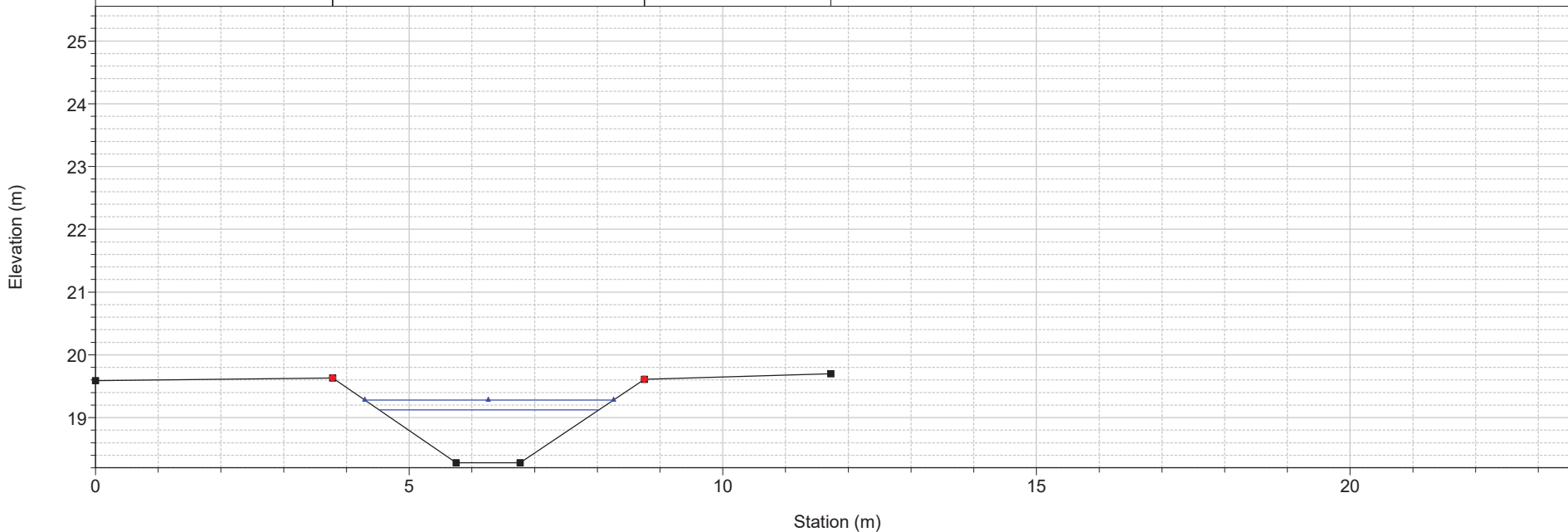
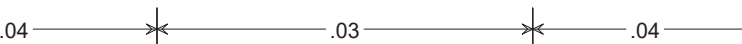

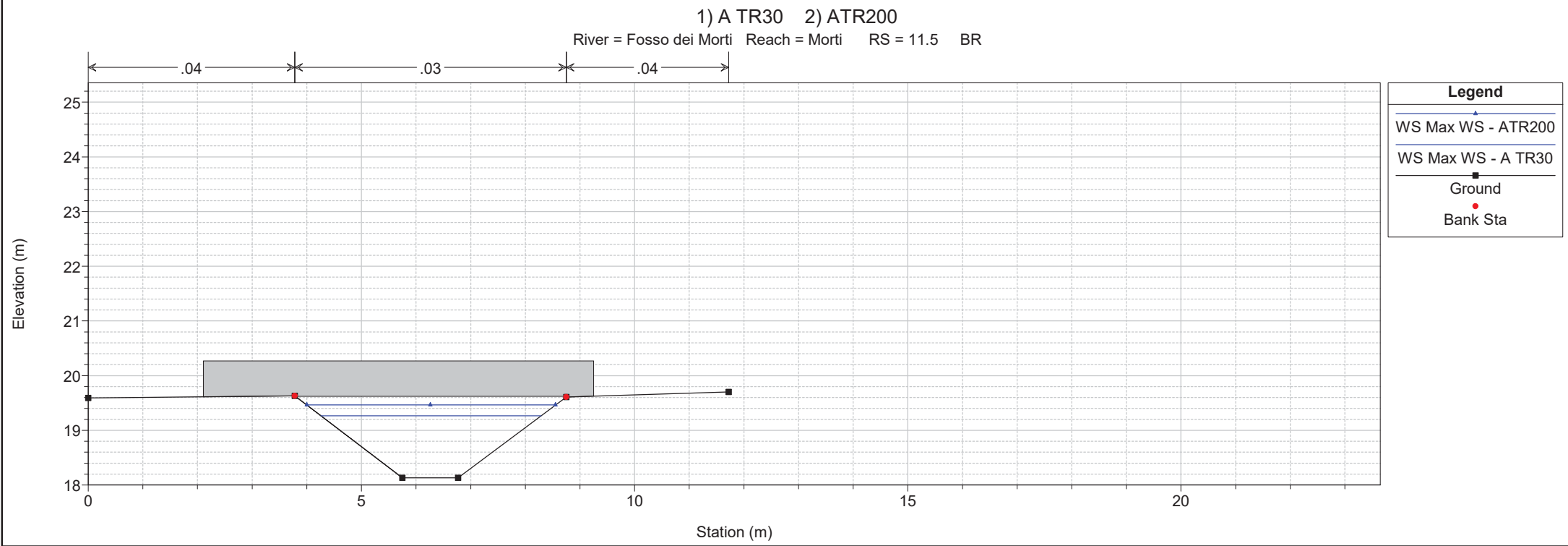
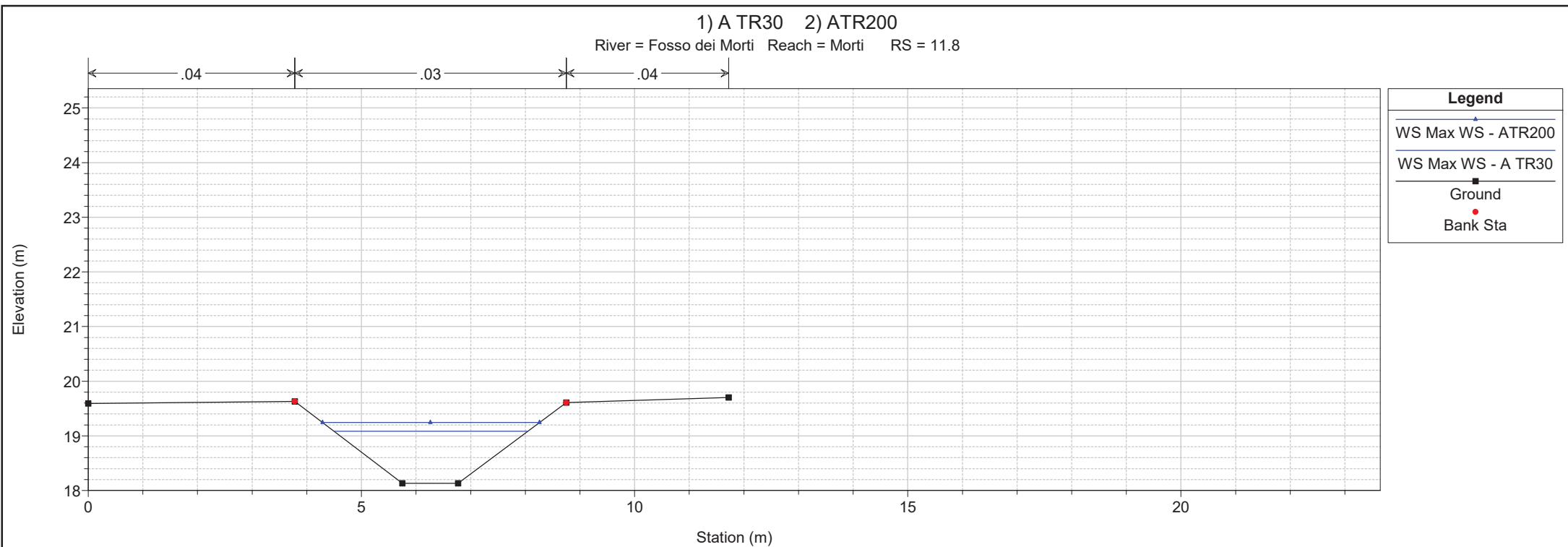

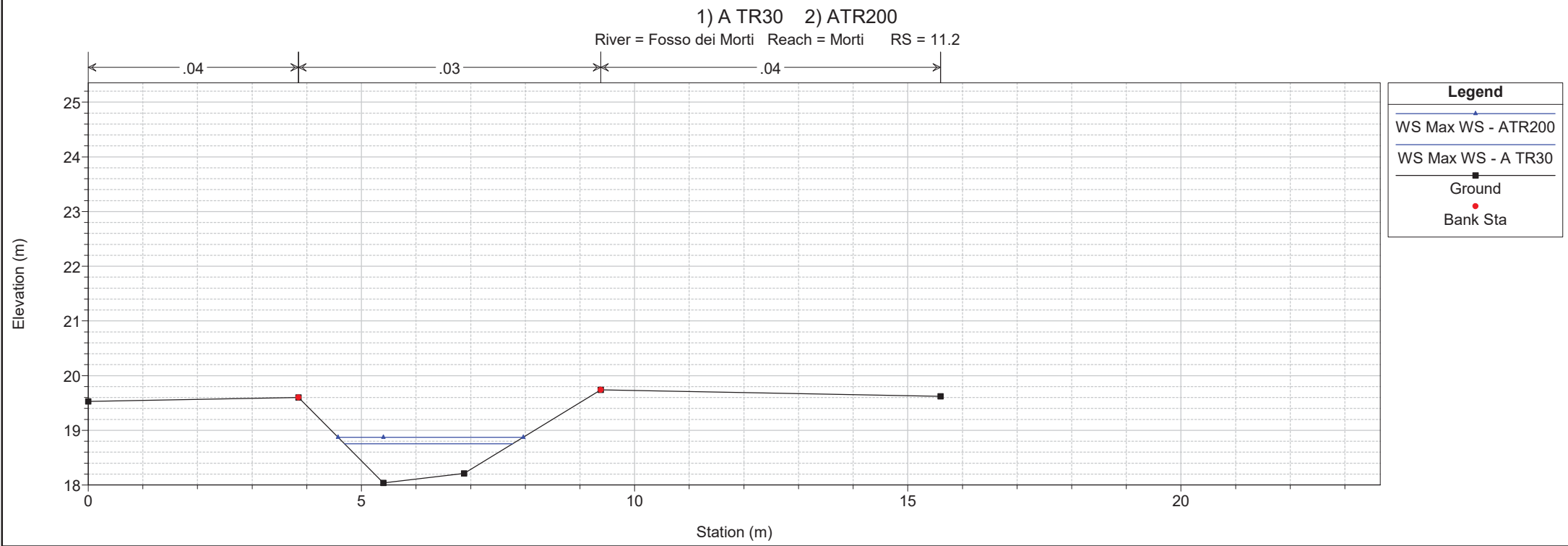
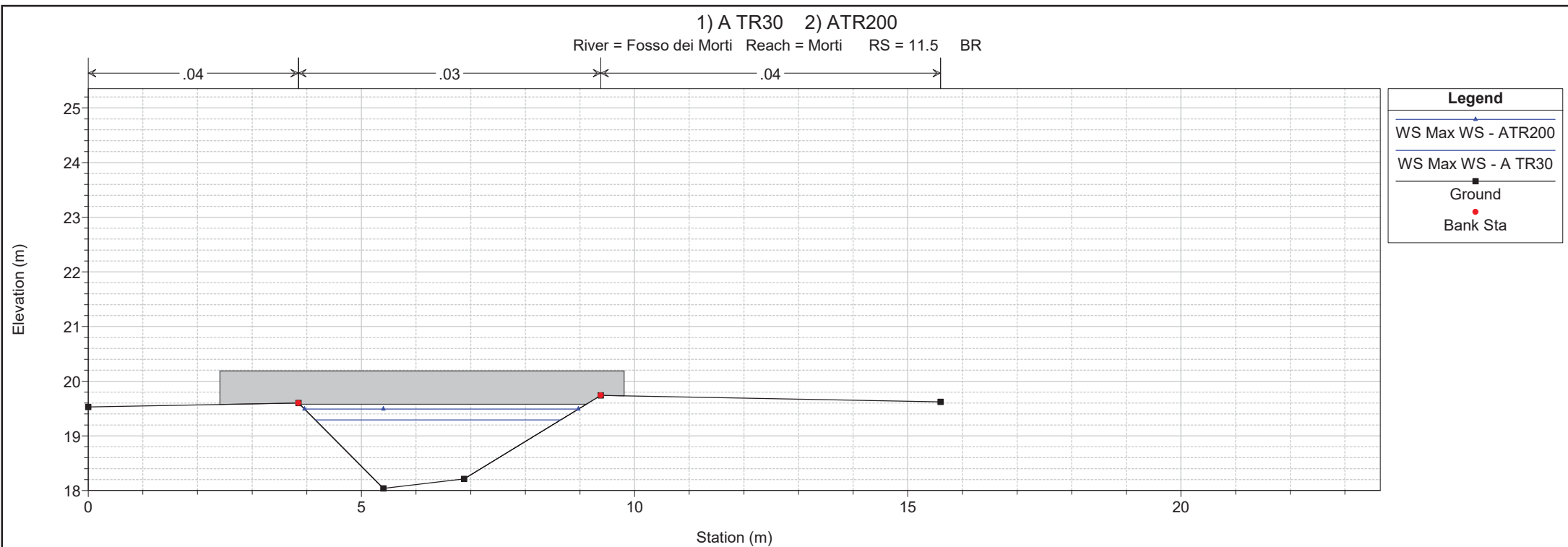

1) A TR30 2) ATR200

River = Fosso dei Morti Reach = Morti RS = 11 Sez. 26

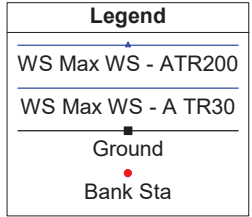
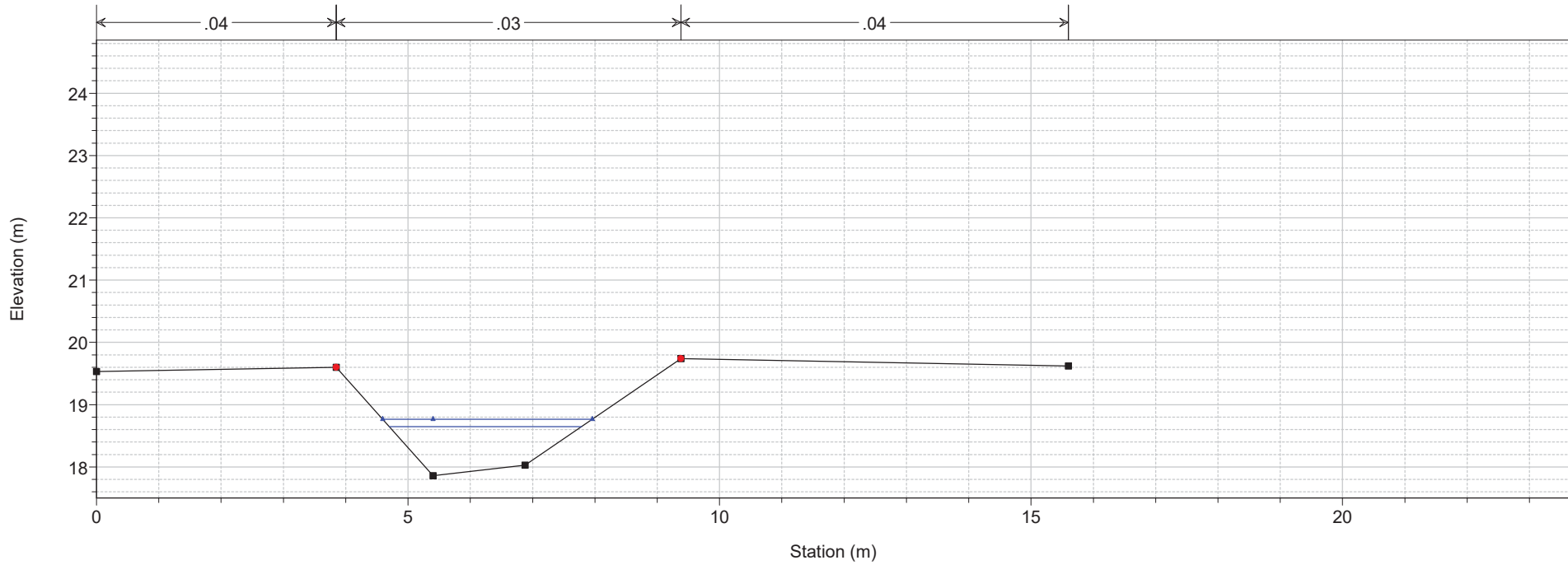

1) A TR30 2) ATR200

River = Fosso dei Morti Reach = Morti RS = 10.1 Sez. 27

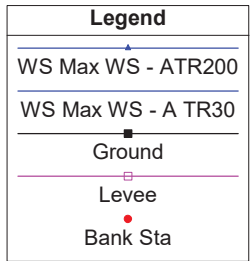
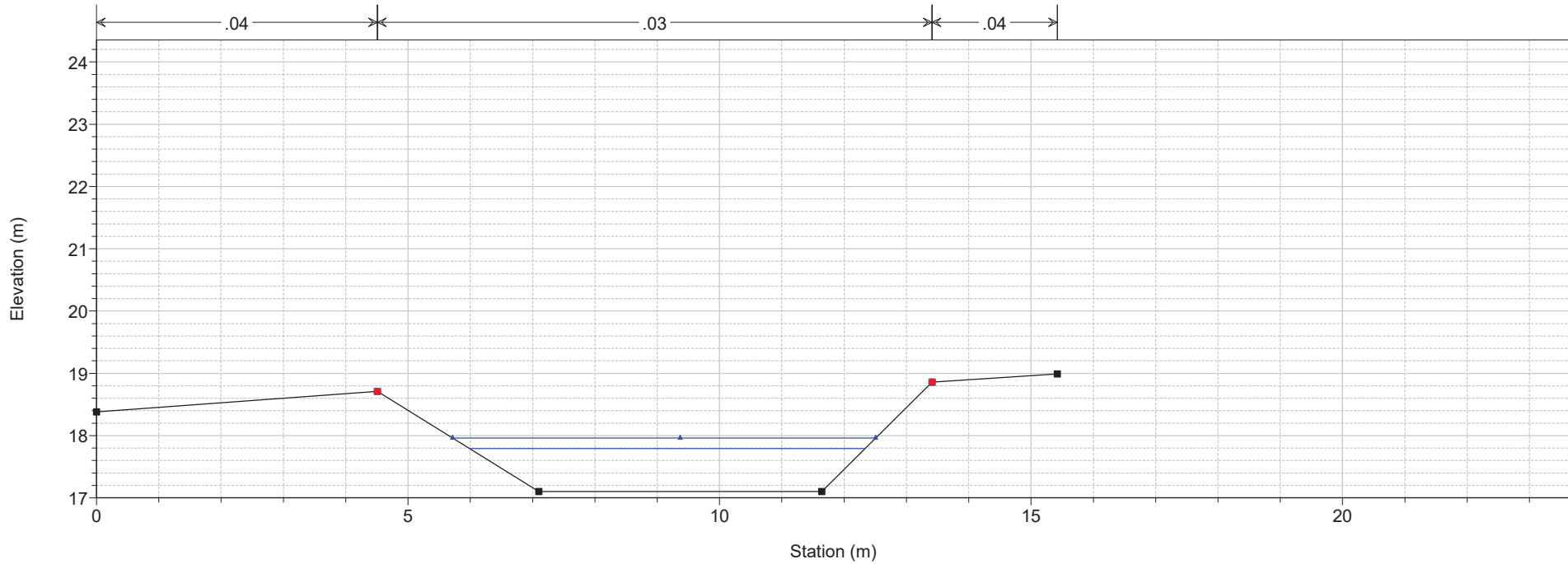

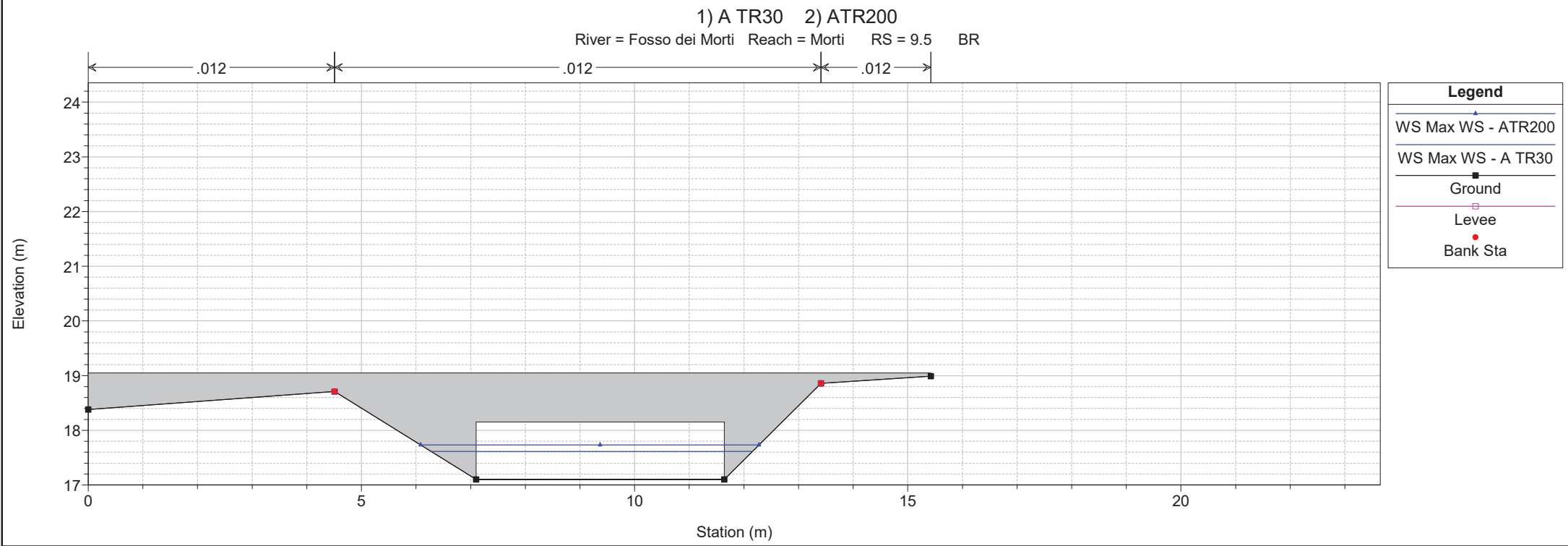
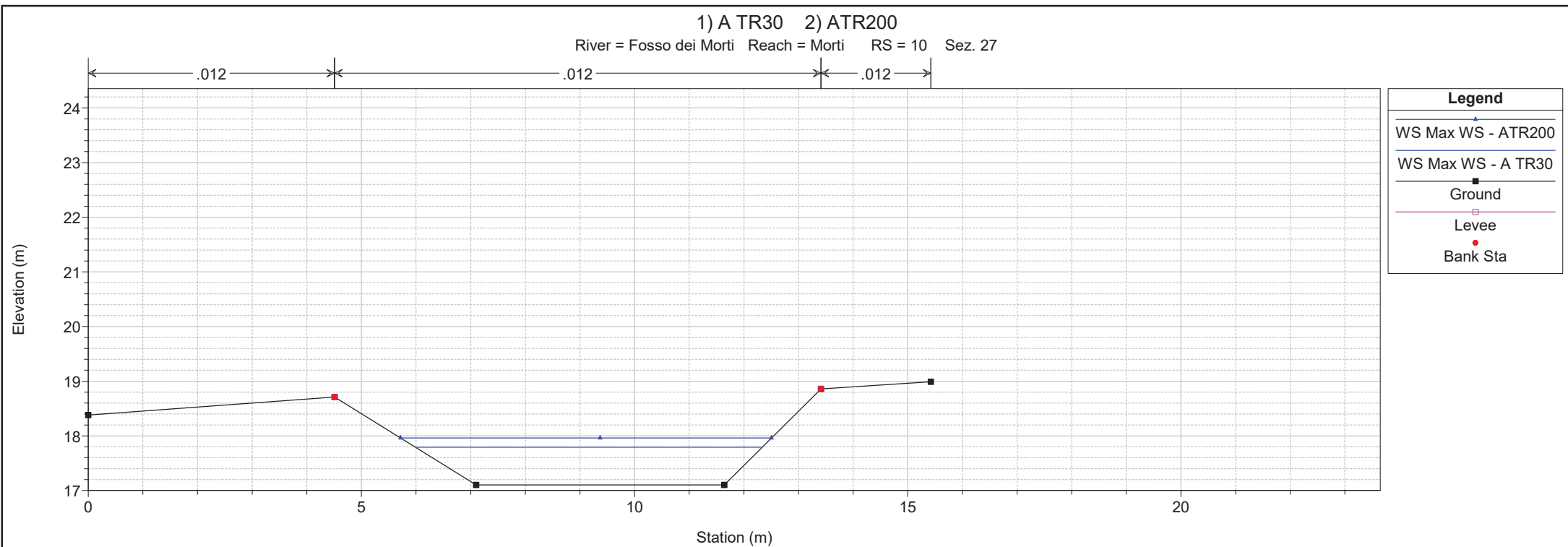

1 cm Horiz. = 1 m 1 cm Vert. = 1 m

1) A TR30 2) ATR200

River = Fosso dei Morti Reach = Morti RS = 9.5 BR

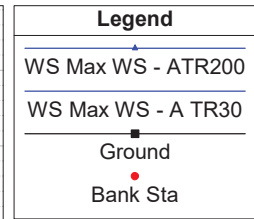
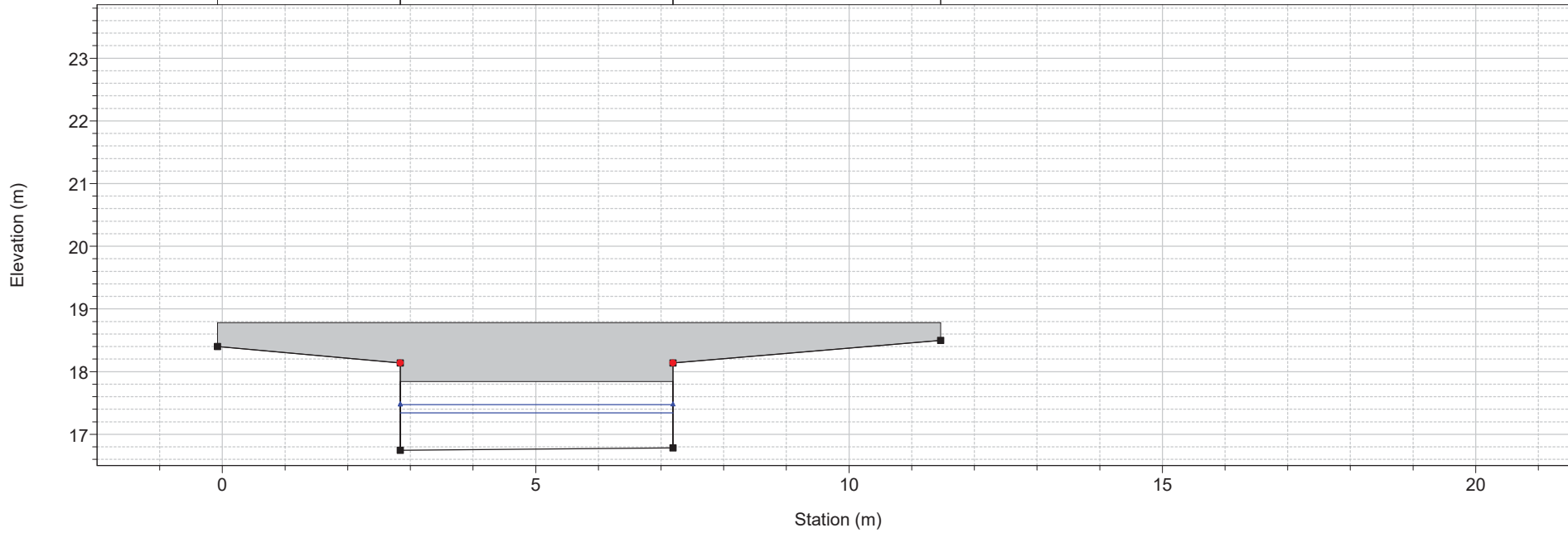

1) A TR30 2) ATR200

River = Fosso dei Morti Reach = Morti RS = 9.2

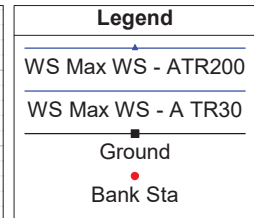
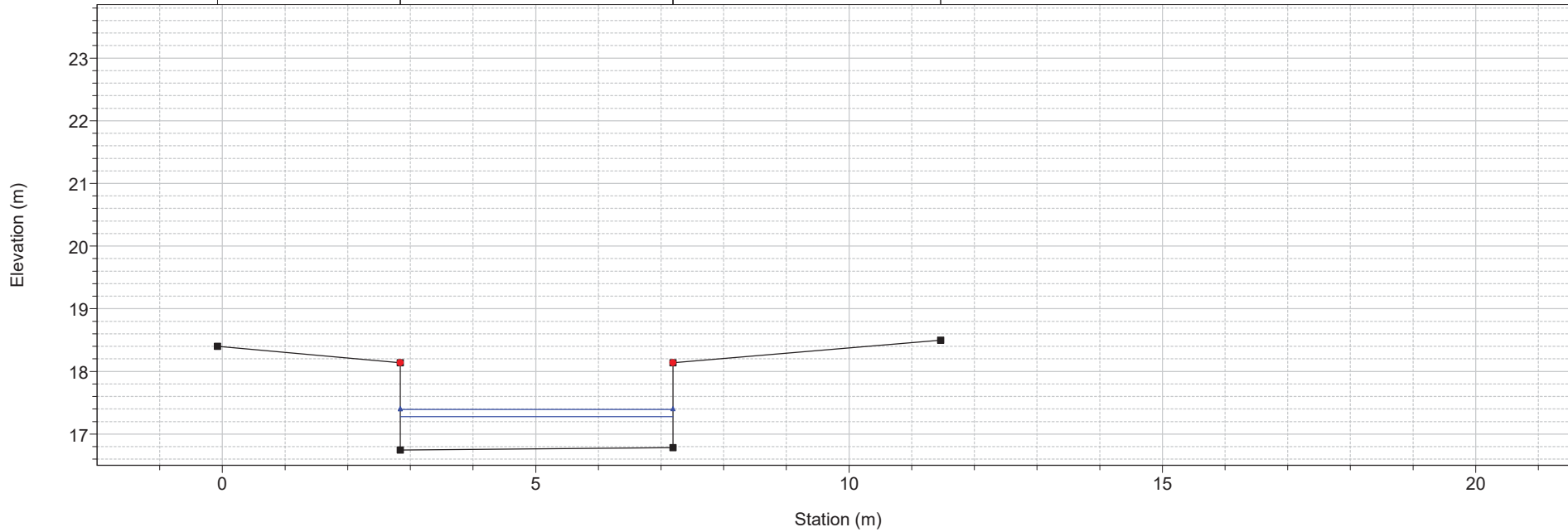

1) A TR30 2) ATR200

River = Fosso dei Morti Reach = Morti RS = 9 Sez. 28

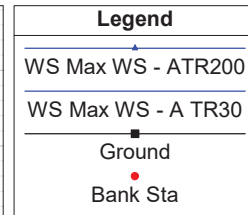
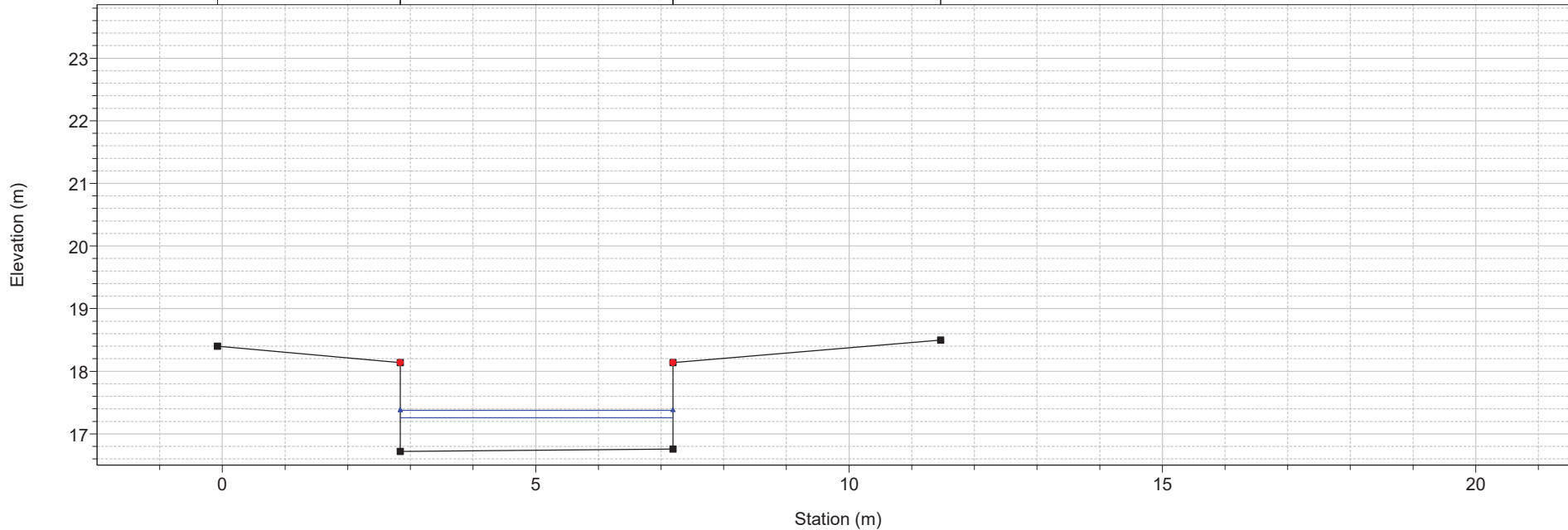

1) A TR30 2) ATR200

River = Fosso dei Morti Reach = Morti RS = 8 Sez. 29

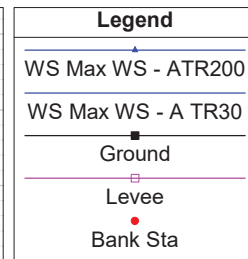
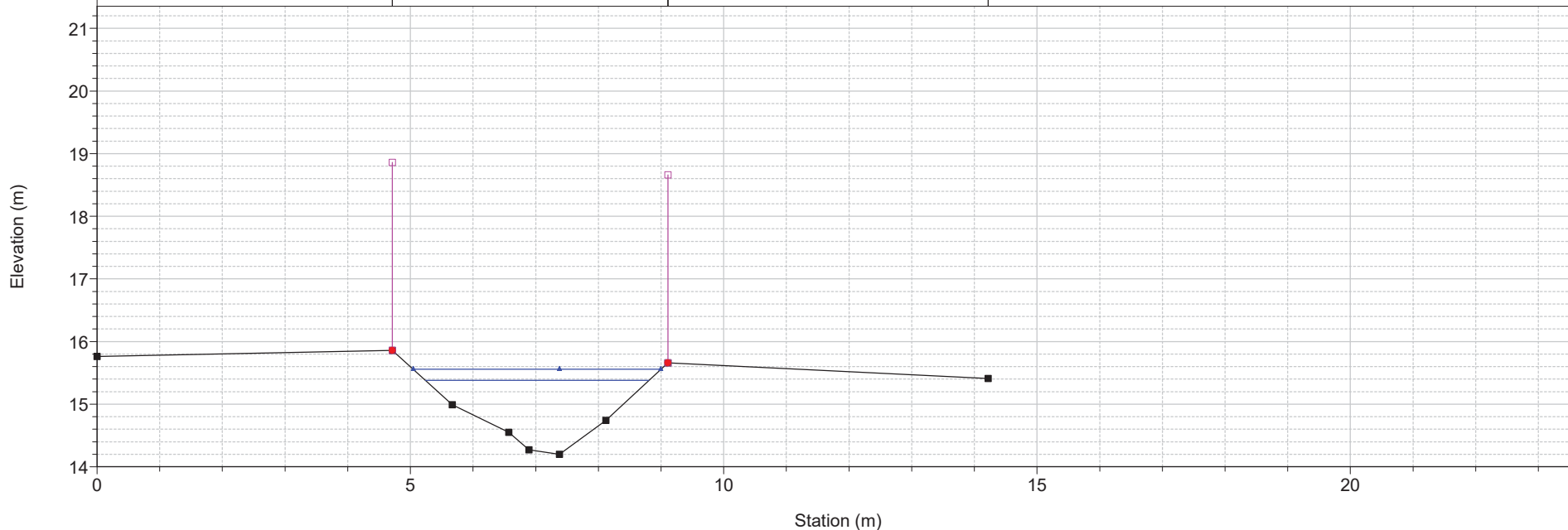
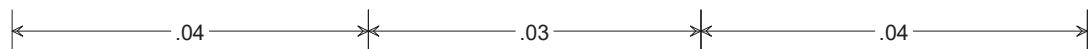

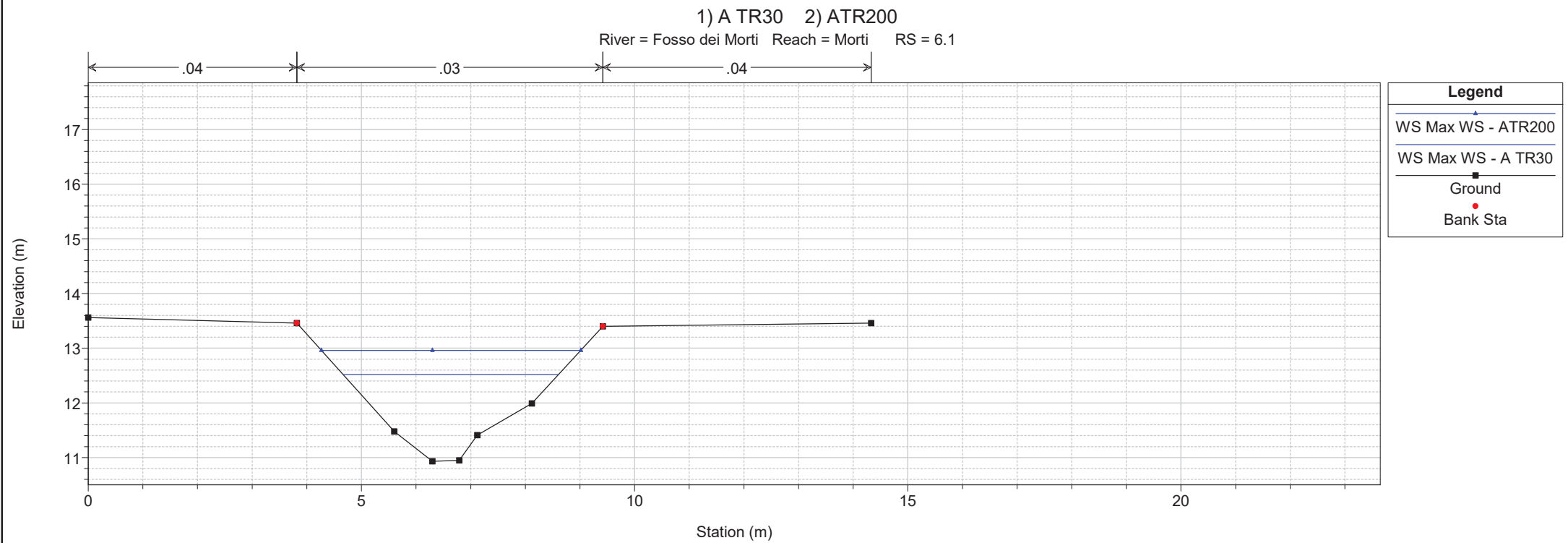
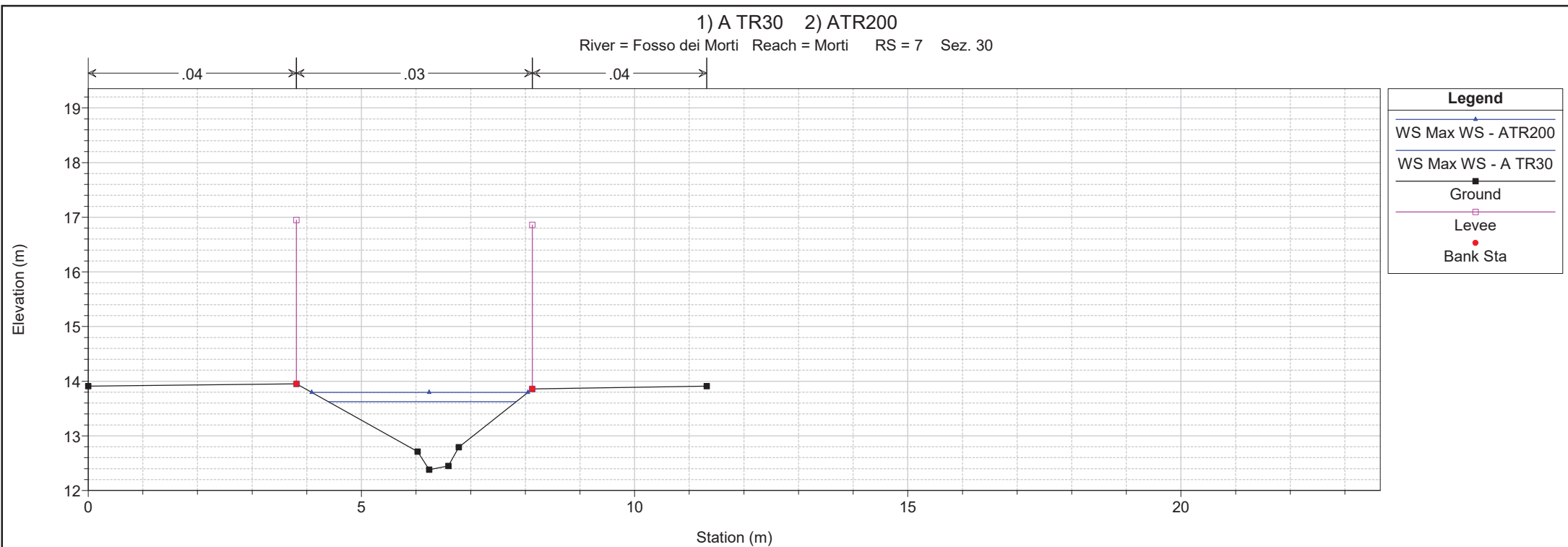

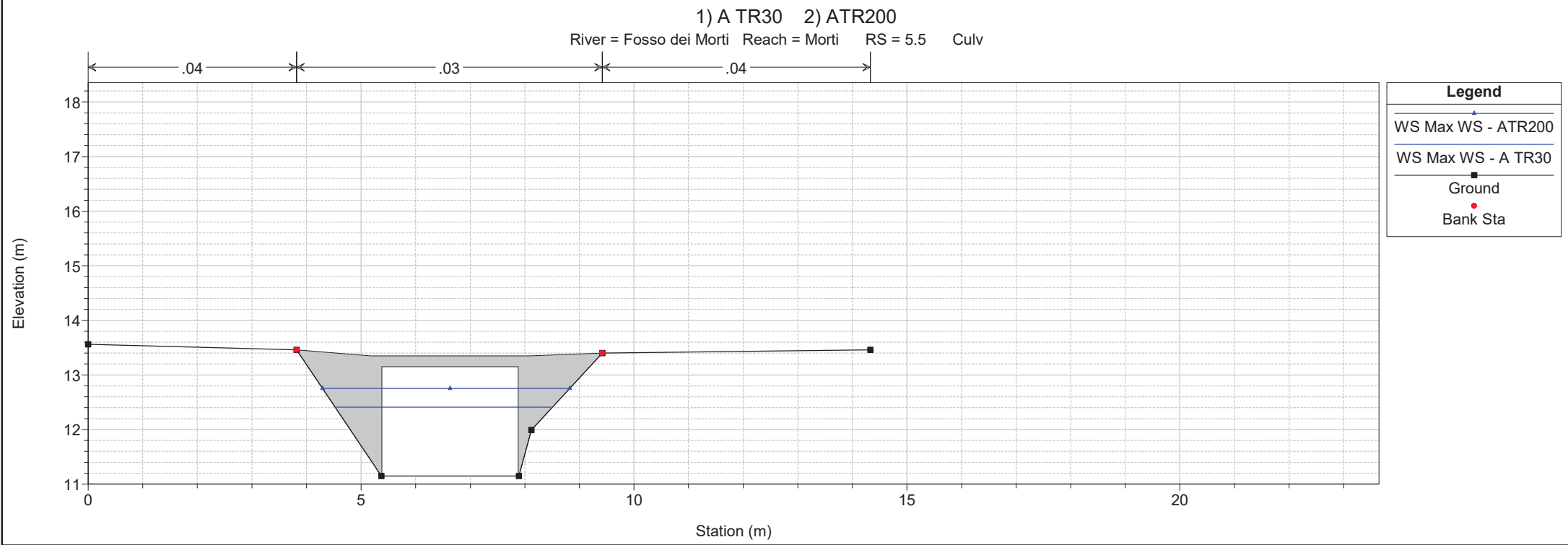
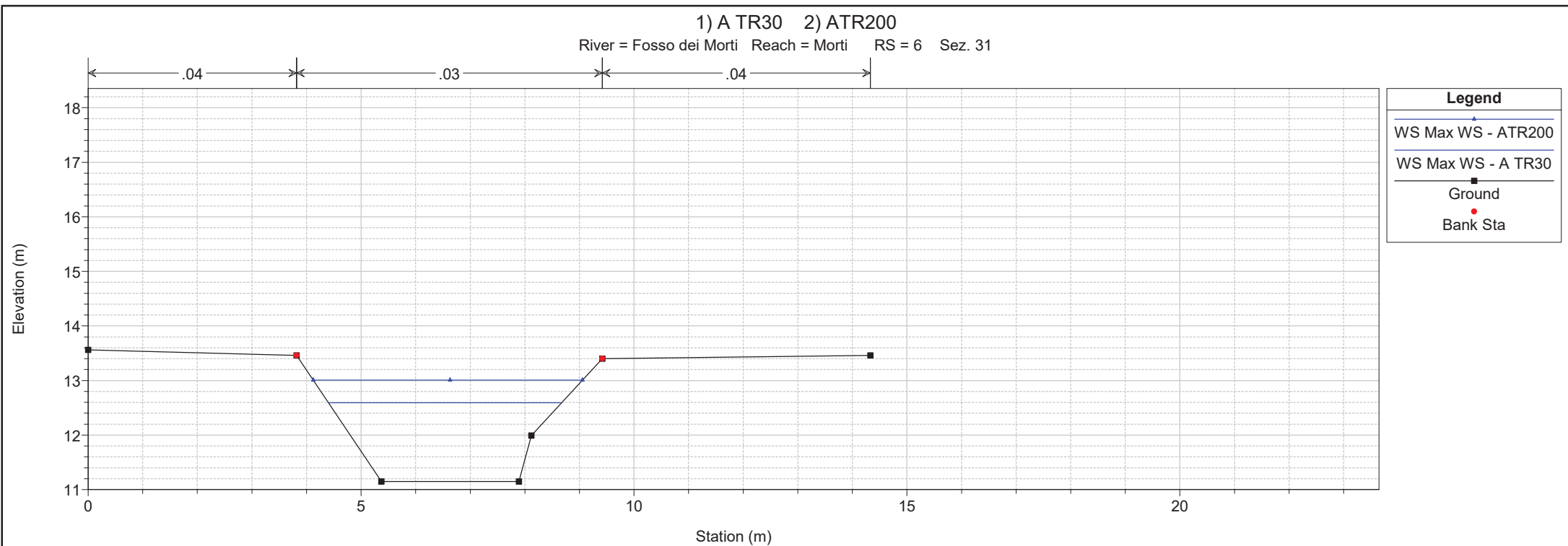

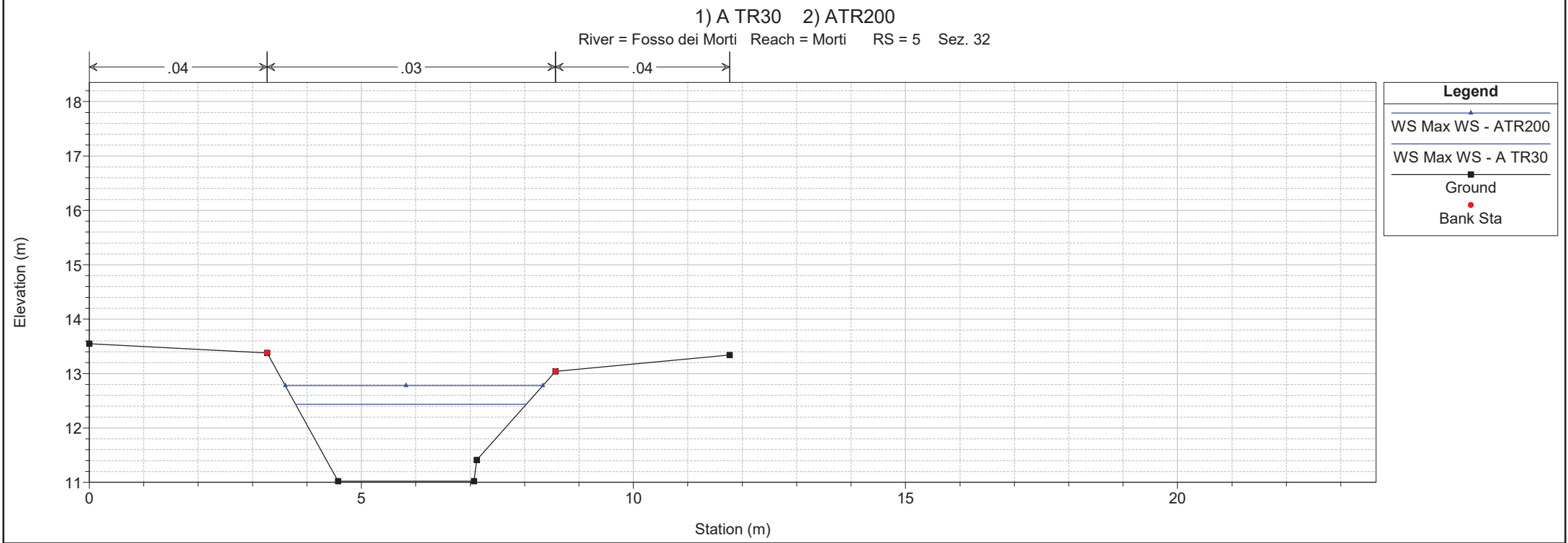
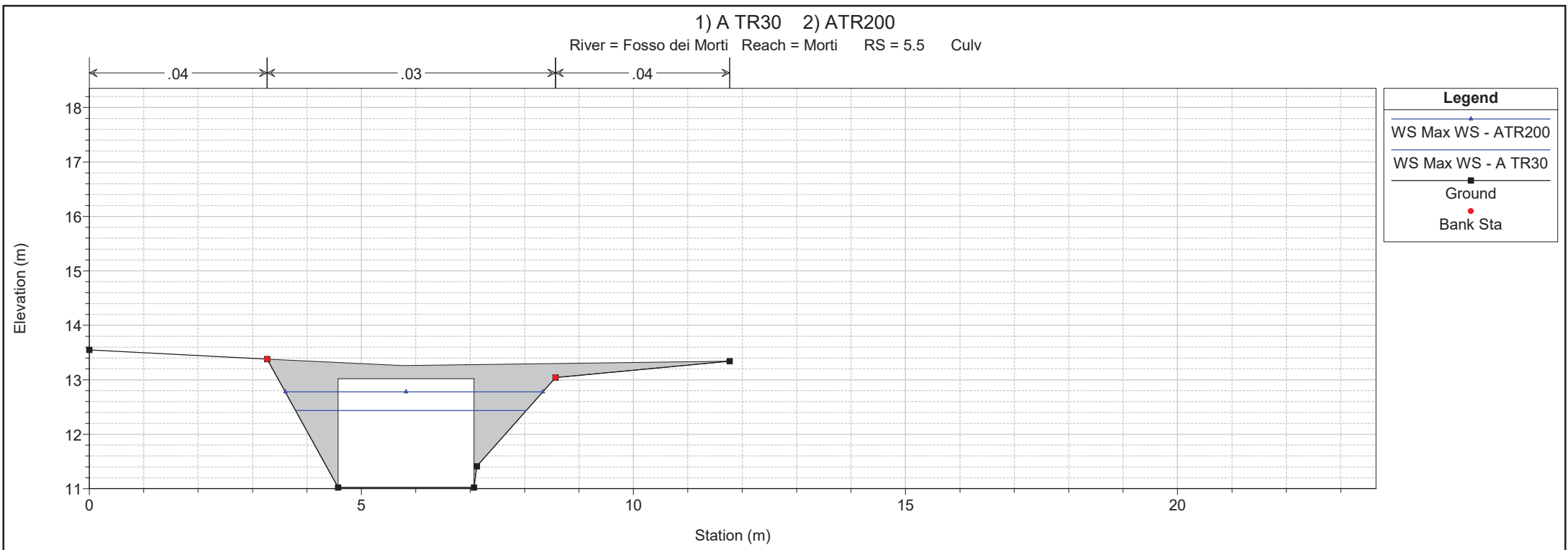

1 cm Horiz. = 1 m 1 cm Vert. = 1 m

1) A TR30 2) ATR200

River = Fosso dei Morti Reach = Morti RS = 4.9

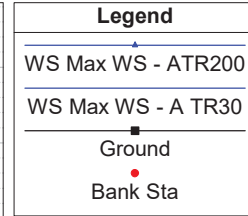
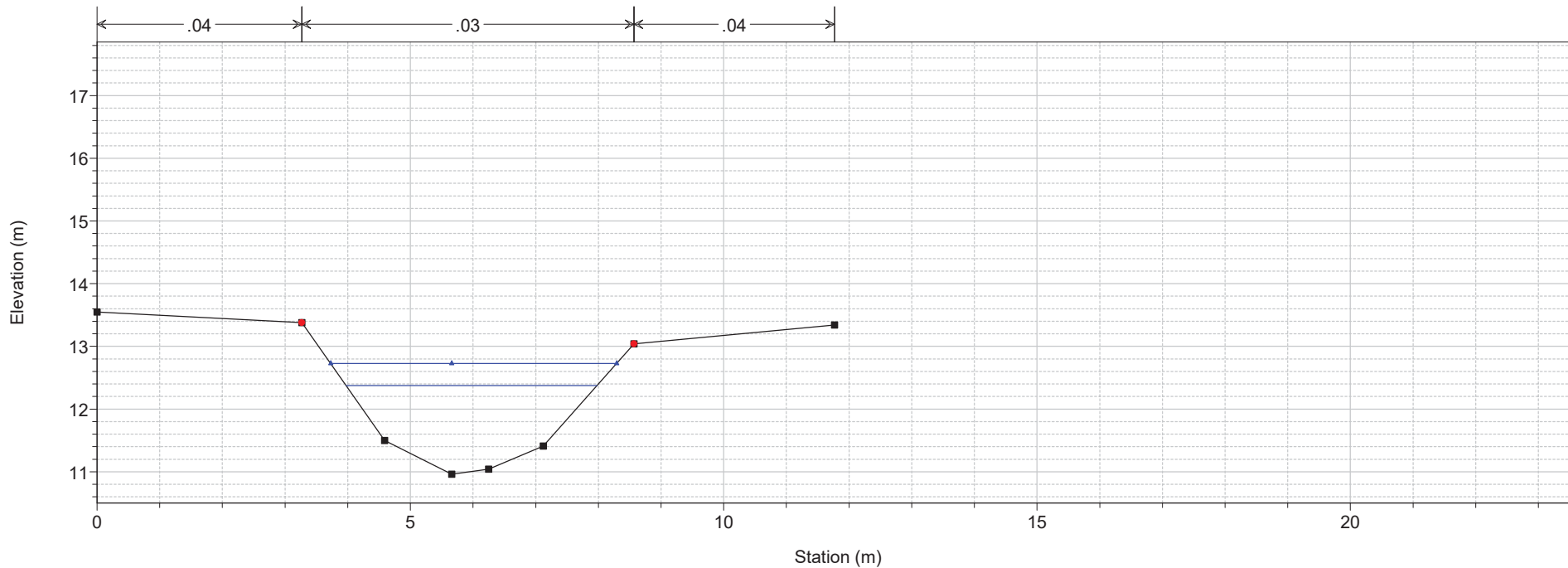

1) A TR30 2) ATR200

River = Fosso dei Morti Reach = Morti RS = 4 Sez. 33

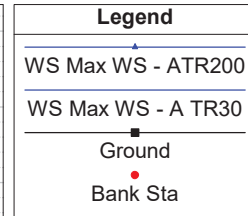
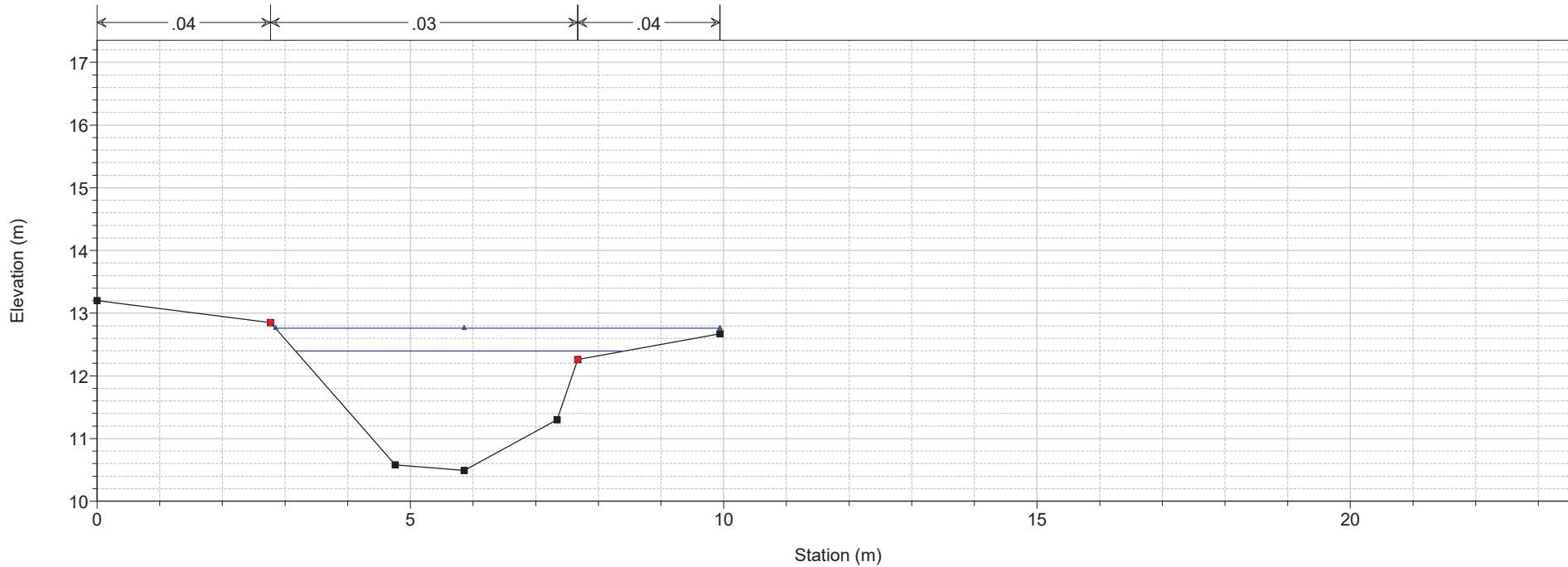

1) A TR30 2) ATR200

River = Fosso dei Morti Reach = Morti RS = 3 Sez. 34

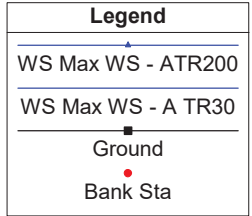
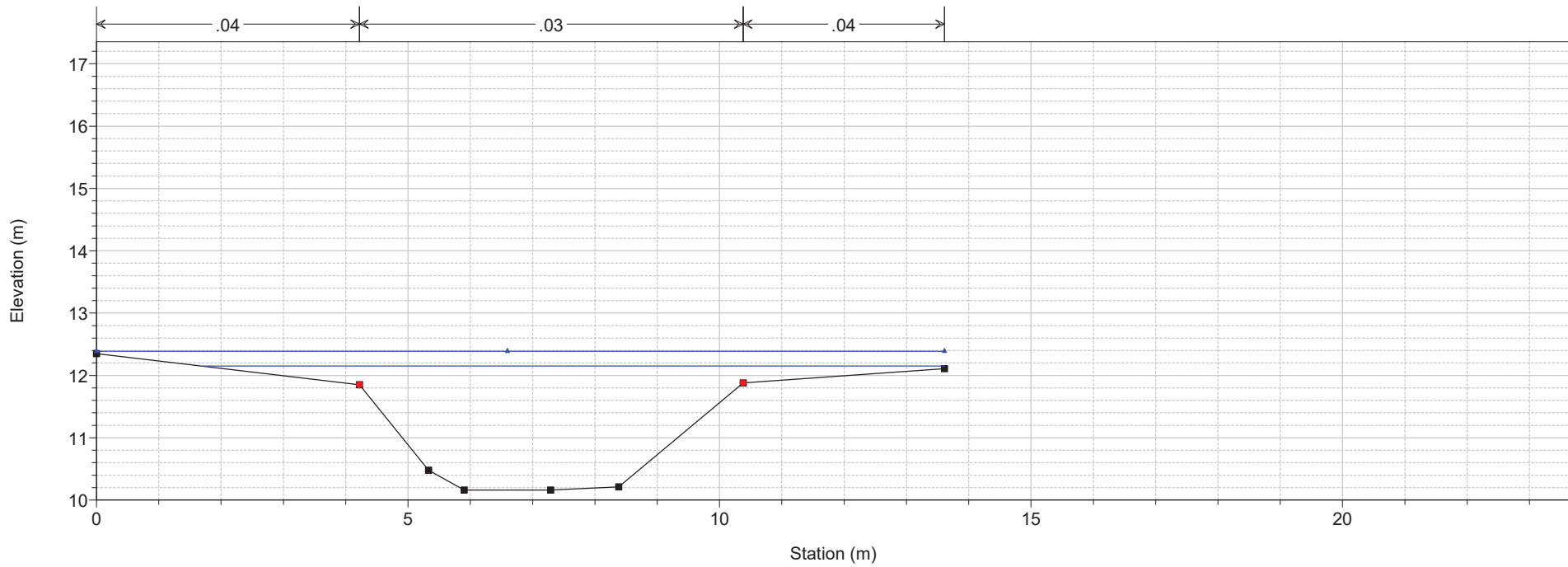

1) A TR30 2) ATR200

River = Fosso dei Morti Reach = Morti RS = 2.5 Culv

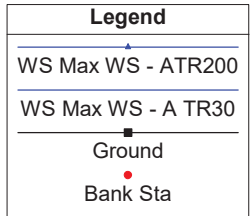
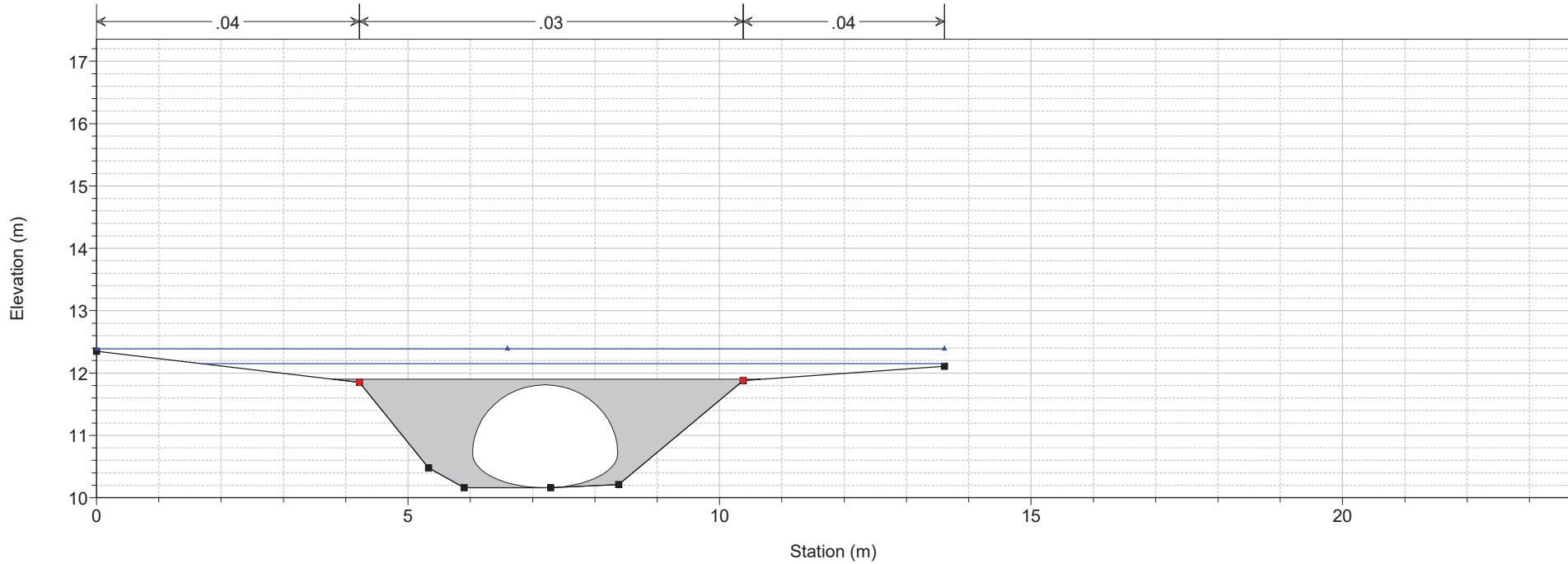

1) A TR30 2) ATR200

River = Fosso dei Morti Reach = Morti RS = 2.5 Culv

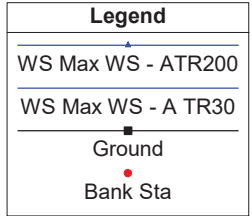
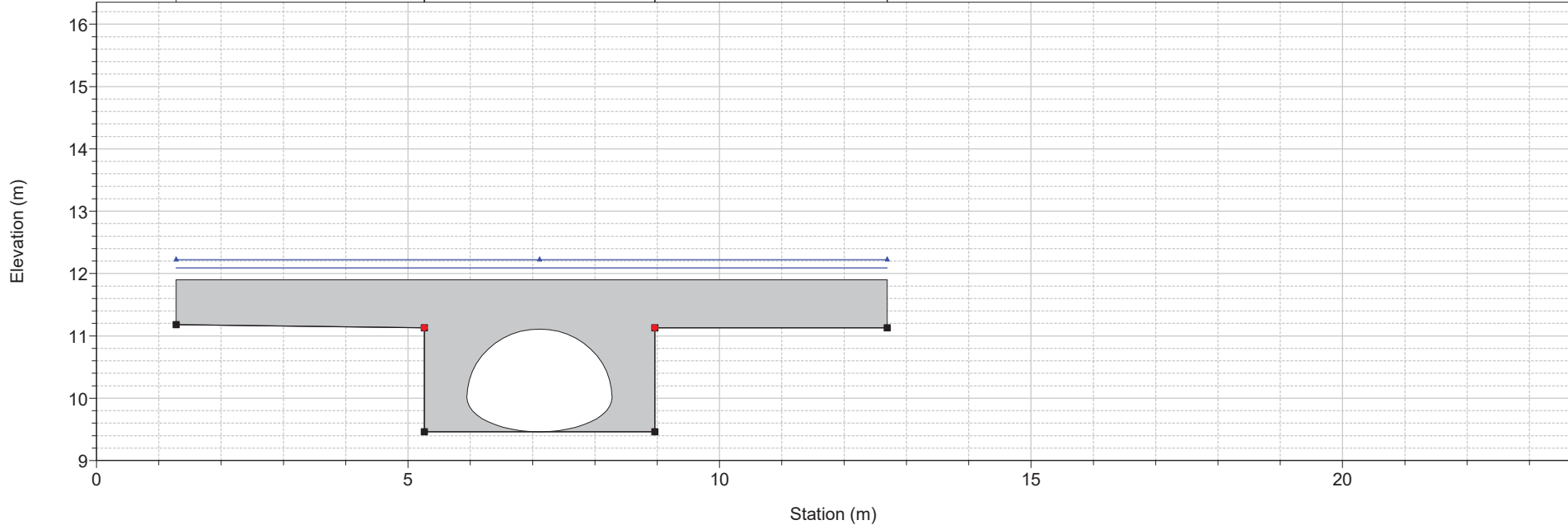
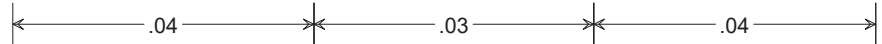

1) A TR30 2) ATR200

River = Fosso dei Morti Reach = Morti RS = 2.1 Sez. 35

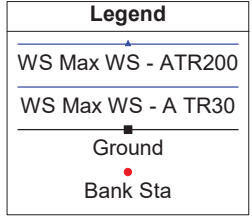
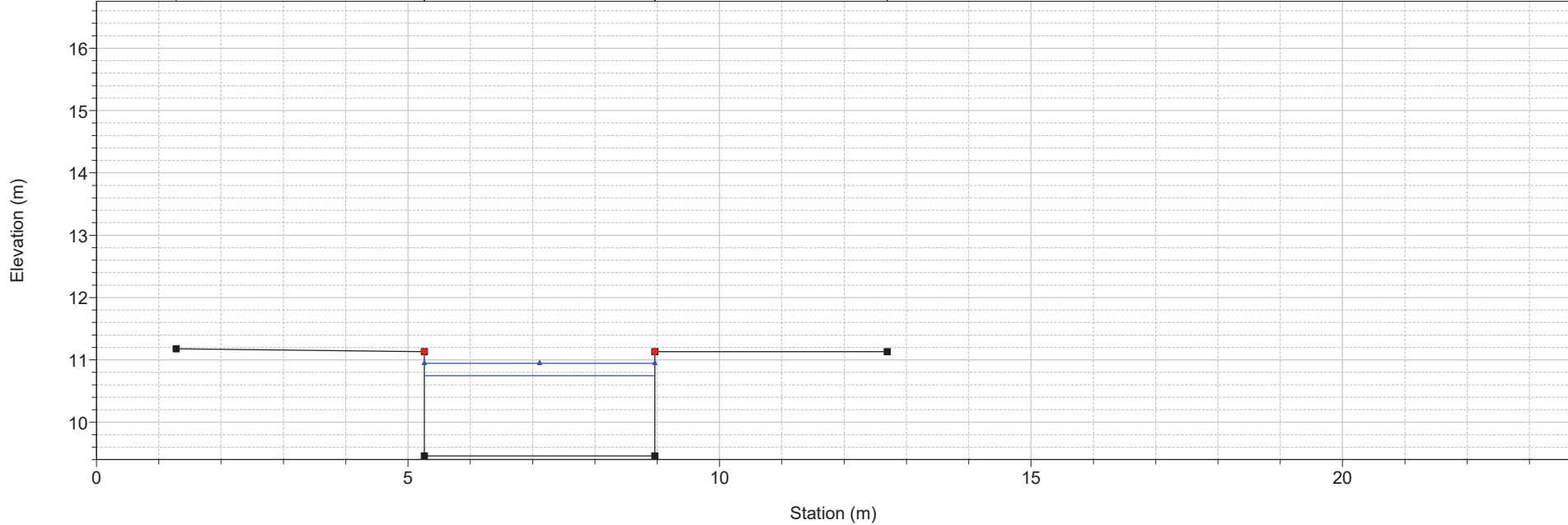
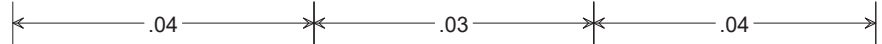

1) A TR30 2) ATR200

River = Fosso dei Morti Reach = Morti RS = 2 Sez. 35

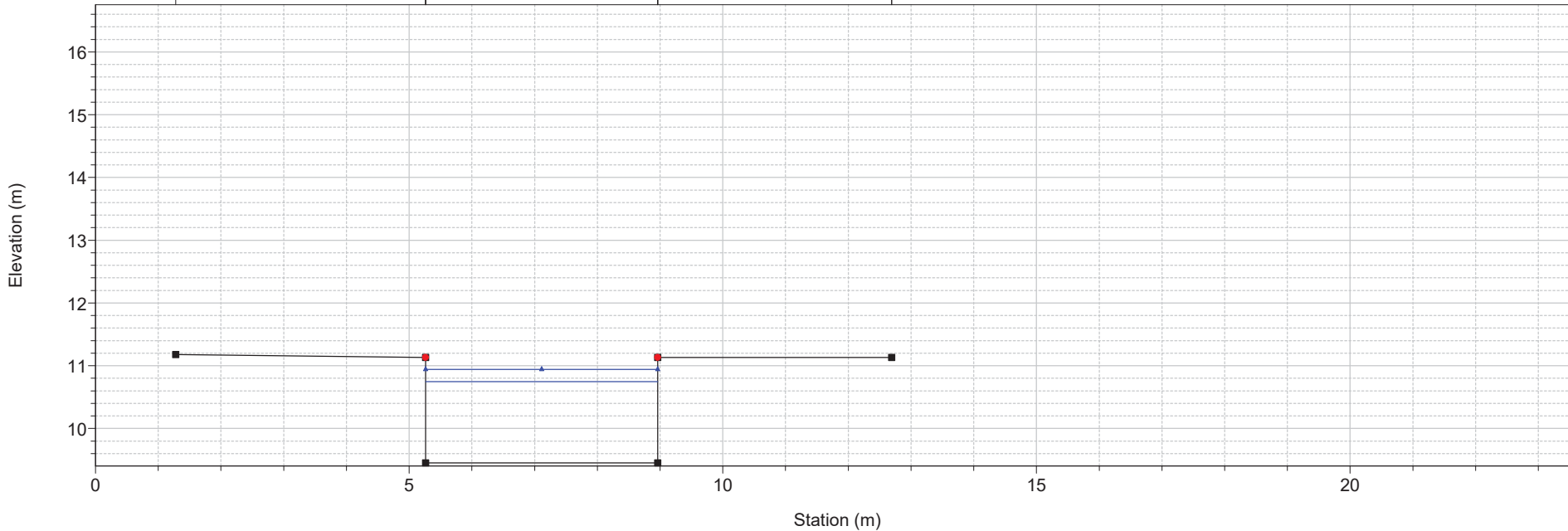
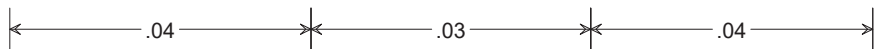

1) A TR30 2) ATR200

River = Fosso dei Morti Reach = Morti RS = 1 Sez. 36

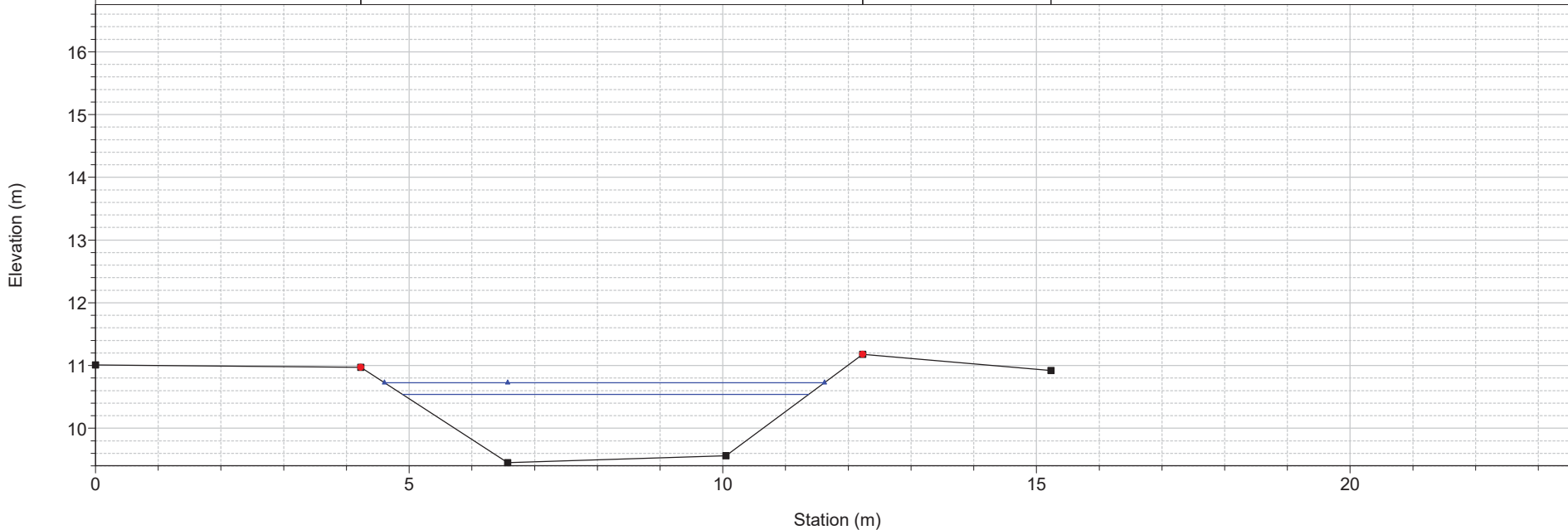

Reach	River Sta	Plan	Q Total (m3/s)	Min Ch El (m)	W.S. Elev (m)	Crit W.S. (m)	E.G. Elev (m)	E.G. Slope (m/m)	Vel Chnl (m/s)	Flow Area (m2)	Top Width (m)	Froude # Chl
Morti	40	A TR30	12.63	51.84	53.55	53.50	53.78	0.005812	2.41	7.20	12.76	0.71
Morti	40	ATR200	19.19	51.84	53.84	53.71	54.06	0.004469	2.46	11.39	15.66	0.65
Morti	39.99	A TR30	12.63	51.84	53.16	53.50	54.23	0.037021	4.63	2.98	8.48	1.68
Morti	39.99	ATR200	19.19	51.84	53.33	53.71	54.56	0.035459	5.19	4.67	10.64	1.70
Morti	39.98		Lat Struct									
Morti	39.97		Lat Struct									
Morti	39	A TR30	12.62	47.91	49.35	49.67	50.20	0.025668	4.09	3.08	3.25	1.34
Morti	39	ATR200	18.61	47.91	49.55	49.91	50.65	0.029048	4.76	4.41	7.58	1.45
Morti	38	A TR30	12.73	45.43	47.71	46.58	47.74	0.000327	0.93	19.47	11.34	0.20
Morti	38	ATR200	18.22	45.43	48.54	46.73	48.57	0.000206	0.92	28.91	11.34	0.17
Morti	37.9	A TR30	12.52	45.01	47.71		47.74	0.000275	0.85	20.50	11.34	0.17
Morti	37.9	ATR200	18.20	45.01	48.55		48.57	0.000191	0.87	29.95	11.34	0.15
Morti	37.5		Culvert									
Morti	37.1	A TR30	12.52	44.91	46.54	46.62	46.98	0.014682	3.14	4.78	7.17	0.86
Morti	37.1	ATR200	18.20	44.91	46.70	46.84	47.29	0.018743	3.69	6.03	7.78	0.97
Morti	37	A TR30	12.51	45.11	46.52	46.71	47.03	0.019878	3.48	5.00	13.82	1.04
Morti	37	ATR200	18.20	45.11	46.69	46.85	47.15	0.019114	3.57	7.71	18.96	1.01
Morti	36.97		Lat Struct									
Morti	36	A TR30	4.51	43.50	45.22		45.27	0.001205	1.01	4.68	6.71	0.30
Morti	36	ATR200	4.98	43.50	45.26		45.31	0.001336	1.08	4.90	7.17	0.31
Morti	35.5		Culvert									
Morti	35	A TR30	4.51	43.07	44.08	43.92	44.28	0.007332	1.94	2.32	3.18	0.73
Morti	35	ATR200	4.98	43.07	44.11	43.97	44.33	0.008230	2.08	2.39	3.21	0.77
Morti	34.97		Lat Struct									
Morti	34	A TR30	3.06	42.49	44.11	43.24	44.14	0.000885	0.84	3.80	3.77	0.24
Morti	34	ATR200	3.19	42.49	44.14	43.26	44.17	0.000893	0.85	3.92	3.83	0.24
Morti	33.9	A TR30	2.54	42.43	44.13	43.10	44.15	0.000288	0.66	4.01	3.81	0.18
Morti	33.9	ATR200	2.56	42.43	44.16	43.11	44.18	0.000271	0.65	4.14	3.89	0.18
Morti	33.5		Bridge									
Morti	33.1	A TR30	2.54	41.92	42.13	42.40	43.48	0.128298	5.15	0.49	2.62	3.79
Morti	33.1	ATR200	2.56	41.92	42.13	42.40	43.49	0.128124	5.16	0.50	2.62	3.79
Morti	33	A TR30	2.54	41.54	41.98	42.07	42.31	0.028048	2.54	1.00	2.93	1.39
Morti	33	ATR200	2.56	41.54	41.98	42.07	42.31	0.028048	2.55	1.00	2.93	1.39
Morti	32	A TR30	2.54	40.24	40.73	40.84	41.09	0.031917	2.69	0.94	2.85	1.49
Morti	32	ATR200	2.56	40.24	40.73	40.84	41.10	0.031842	2.69	0.95	2.85	1.49
Morti	31	A TR30	2.54	37.73	38.46	38.11	38.50	0.001762	0.91	2.77	3.95	0.35
Morti	31	ATR200	2.56	37.73	38.47	38.11	38.51	0.001760	0.92	2.79	3.95	0.35
Morti	30.9	A TR30	2.54	37.71	38.46	38.09	38.50	0.000877	0.89	2.85	3.95	0.33
Morti	30.9	ATR200	2.56	37.71	38.46	38.09	38.51	0.000878	0.89	2.86	3.95	0.34
Morti	30.5		Bridge									
Morti	30.1	A TR30	2.54	37.63	38.27	38.13	38.39	0.003499	1.51	1.68	3.00	0.64
Morti	30.1	ATR200	2.56	37.63	38.27	38.13	38.39	0.003512	1.52	1.69	3.00	0.65
Morti	30	A TR30	2.54	37.62	38.27	38.12	38.38	0.006311	1.50	1.70	3.00	0.64
Morti	30	ATR200	2.56	37.62	38.27	38.12	38.38	0.006336	1.50	1.70	3.00	0.64
Morti	29	A TR30	2.54	37.19	37.72	37.76	37.96	0.017472	2.15	1.18	3.16	1.12
Morti	29	ATR200	2.56	37.19	37.73	37.76	37.96	0.017434	2.16	1.19	3.17	1.12
Morti	28	A TR30	2.54	36.08	36.75	36.79	37.02	0.018013	2.31	1.10	2.50	1.11
Morti	28	ATR200	2.56	36.08	36.75	36.79	37.03	0.018008	2.32	1.11	2.50	1.11
Morti	27	A TR30	2.54	34.50	35.03	35.12	35.39	0.027353	2.67	0.95	2.41	1.36
Morti	27	ATR200	2.56	34.50	35.03	35.13	35.40	0.027371	2.67	0.96	2.42	1.36

Reach	River Sta	Plan	Q Total (m3/s)	Min Ch El (m)	W.S. Elev (m)	Crit W.S. (m)	E.G. Elev (m)	E.G. Slope (m/m)	Vel Chnl (m/s)	Flow Area (m2)	Top Width (m)	Froude # Chl
Morti	26	A TR30	2.53	30.23	30.59	30.81	31.38	0.101539	3.96	0.64	2.65	2.57
Morti	26	ATR200	2.54	30.23	30.59	30.81	31.39	0.101109	3.96	0.64	2.65	2.57
Morti	25.5	A TR30	2.29	28.18	29.38	28.83	29.40	0.000820	0.76	3.75	7.08	0.26
Morti	25.5	ATR200	2.25	28.18	29.41	28.82	29.43	0.000675	0.71	4.00	7.11	0.23
Morti	25	A TR30	2.22	28.11	29.37	28.78	29.37	0.000008	0.08	44.89	80.73	0.03
Morti	25	ATR200	2.27	28.11	29.40	28.78	29.40	0.000007	0.07	47.60	80.76	0.02
Morti	24	A TR30	2.21	28.05	29.37	28.68	29.37	0.000004	0.06	60.29	89.77	0.02
Morti	24	ATR200	2.26	28.05	29.40	28.68	29.40	0.000003	0.06	63.31	89.86	0.02
Morti	23	A TR30	2.21	27.99	29.37	28.62	29.37	0.000002	0.05	66.39	84.10	0.01
Morti	23	ATR200	2.26	27.99	29.40	28.62	29.40	0.000002	0.05	69.21	84.26	0.01
Morti	22	A TR30	2.21	27.97	29.37		29.37	0.000014	0.12	34.11	81.94	0.03
Morti	22	ATR200	2.25	27.97	29.40		29.40	0.000012	0.12	36.86	82.10	0.03
Morti	21.5		Culvert									
Morti	21	A TR30	2.21	27.85	28.08	28.13	28.28	0.026690	1.94	1.14	4.87	1.28
Morti	21	ATR200	2.25	27.85	28.09	28.13	28.28	0.026676	1.96	1.15	4.87	1.28
Morti	20.80	A TR30	2.21	27.22	27.47	27.52	27.68	0.025460	2.00	1.11	4.47	1.28
Morti	20.80	ATR200	2.25	27.22	27.48	27.52	27.68	0.025421	2.01	1.12	4.48	1.28
Morti	20	A TR30	2.48	24.69	25.31	25.31	25.53	0.014291	2.09	1.19	2.63	0.99
Morti	20	ATR200	2.86	24.69	25.37	25.36	25.60	0.013291	2.12	1.35	2.73	0.96
Morti	19.9	A TR30	2.55	24.61	25.26	25.08	25.37	0.002713	1.42	1.80	3.15	0.60
Morti	19.9	ATR200	2.96	24.61	25.34	25.13	25.45	0.002563	1.45	2.04	3.25	0.59
Morti	19.5		Bridge									
Morti	19.1	A TR30	2.55	24.50	25.04	24.97	25.18	0.004661	1.66	1.54	3.52	0.80
Morti	19.1	ATR200	2.96	24.50	25.08	25.01	25.24	0.004797	1.75	1.69	3.63	0.82
Morti	19	A TR30	2.56	24.47	25.01	25.05	25.25	0.019398	2.19	1.17	3.34	1.18
Morti	19	ATR200	2.99	24.47	25.05	25.10	25.31	0.018627	2.26	1.32	3.45	1.17
Morti	18	A TR30	2.77	23.85	24.50	24.39	24.63	0.006762	1.57	1.77	3.68	0.72
Morti	18	ATR200	3.31	23.85	24.58	24.45	24.71	0.006183	1.60	2.07	3.92	0.70
Morti	17	A TR30	3.10	23.34	24.00	23.99	24.22	0.012484	2.04	1.52	3.36	0.97
Morti	17	ATR200	3.83	23.34	24.09	24.07	24.31	0.011729	2.11	1.81	3.62	0.95
Morti	16	A TR30	3.62	22.12	22.93	22.96	23.23	0.016154	2.42	1.49	2.90	1.08
Morti	16	ATR200	4.64	22.12	23.05	23.08	23.37	0.015002	2.51	1.85	3.20	1.05
Morti	15.1	A TR30	4.03	21.12	22.09	21.79	22.25	0.006534	1.77	2.28	2.35	0.57
Morti	15.1	ATR200	5.29	21.12	22.29	21.92	22.48	0.006743	1.92	2.76	2.35	0.57
Morti	15	A TR30	4.04	21.12	22.09	21.79	22.25	0.003535	1.77	2.28	2.35	0.57
Morti	15	ATR200	5.30	21.12	22.29	21.92	22.48	0.003649	1.92	2.75	2.35	0.57
Morti	14.5		Bridge									
Morti	14	A TR30	4.04	21.00	21.68	21.71	22.06	0.011387	2.72	1.48	2.17	1.05
Morti	14	ATR200	5.30	21.00	21.83	21.85	22.27	0.011489	2.94	1.80	2.17	1.03
Morti	13.9	A TR30	4.04	21.00	21.68	21.70	22.06	0.021315	2.73	1.48	2.17	1.05
Morti	13.9	ATR200	5.30	21.00	21.83	21.85	22.27	0.021480	2.95	1.80	2.17	1.04
Morti	13	A TR30	4.37	19.79	20.61	20.70	21.02	0.021184	2.83	1.54	2.74	1.20
Morti	13	ATR200	5.82	19.79	20.73	20.84	21.22	0.022329	3.12	1.87	2.89	1.24
Morti	12	A TR30	4.84	18.28	19.12	19.16	19.45	0.015635	2.53	1.91	3.51	1.10
Morti	12	ATR200	6.55	18.28	19.28	19.31	19.63	0.014010	2.63	2.49	3.97	1.06
Morti	11.8	A TR30	4.86	18.13	19.08	19.04	19.34	0.010648	2.23	2.18	3.55	0.91
Morti	11.8	ATR200	6.58	18.13	19.24	19.19	19.53	0.010219	2.37	2.78	3.97	0.90
Morti	11.5		Bridge									
Morti	11.2	A TR30	4.86	18.04	18.76	18.94	19.34	0.034802	3.40	1.43	3.08	1.59
Morti	11.2	ATR200	6.58	18.04	18.87	19.08	19.55	0.033500	3.64	1.81	3.39	1.59

Reach	River Sta	Plan	Q Total (m3/s)	Min Ch El (m)	W.S. Elev (m)	Crit W.S. (m)	E.G. Elev (m)	E.G. Slope (m/m)	Vel Chnl (m/s)	Flow Area (m2)	Top Width (m)	Froude # Chl
Morti	11	A TR30	4.88	17.86	18.65	18.78	19.12	0.025254	3.06	1.60	3.09	1.36
Morti	11	ATR200	6.62	17.86	18.77	18.93	19.34	0.025813	3.34	1.98	3.36	1.39
Morti	10.1	A TR30	5.29	17.10	17.79	17.59	17.89	0.003950	1.41	3.76	6.34	0.58
Morti	10.1	ATR200	7.18	17.10	17.96	17.70	18.07	0.003381	1.47	4.88	6.79	0.55
Morti	10	A TR30	5.29	17.10	17.79	17.59	17.89	0.000634	1.41	3.75	6.34	0.58
Morti	10	ATR200	7.18	17.10	17.96	17.70	18.07	0.000542	1.47	4.88	6.79	0.55
Morti	9.5		Bridge									
Morti	9.2	A TR30	5.29	16.74	17.28	17.30	17.56	0.002601	2.37	2.23	4.35	1.05
Morti	9.2	ATR200	7.18	16.74	17.40	17.41	17.74	0.002552	2.61	2.75	4.35	1.05
Morti	9	A TR30	5.29	16.72	17.26	17.27	17.54	0.015995	2.36	2.25	4.35	1.05
Morti	9	ATR200	7.20	16.72	17.37	17.39	17.72	0.015779	2.61	2.76	4.35	1.04
Morti	8	A TR30	6.00	14.20	15.38	15.37	15.70	0.012591	2.51	2.39	3.56	0.98
Morti	8	ATR200	8.37	14.20	15.56	15.55	15.94	0.012563	2.74	3.06	3.95	0.99
Morti	7.98		Lat Struct									
Morti	7	A TR30	6.77	12.38	13.63	13.79	14.19	0.027556	3.33	2.03	3.45	1.38
Morti	7	ATR200	9.48	12.38	13.79	13.97	14.44	0.026570	3.57	2.65	3.96	1.39
Morti	6.1	A TR30	6.77	10.93	12.52	12.23	12.70	0.005359	1.89	3.57	3.94	0.64
Morti	6.1	ATR200	9.47	10.93	12.96	12.44	13.11	0.003294	1.72	5.49	4.75	0.51
Morti	6	A TR30	6.77	11.15	12.59		12.70	0.002490	1.43	4.74	4.27	0.43
Morti	6	ATR200	9.47	11.15	13.01		13.11	0.001968	1.43	6.64	4.93	0.39
Morti	5.5		Culvert									
Morti	5	A TR30	6.77	11.02	12.44	11.89	12.55	0.002662	1.46	4.62	4.24	0.45
Morti	5	ATR200	9.47	11.02	12.78	12.09	12.90	0.002404	1.54	6.15	4.73	0.43
Morti	4.9	A TR30	6.76	10.96	12.37	12.06	12.54	0.004547	1.82	3.71	4.00	0.60
Morti	4.9	ATR200	9.47	10.96	12.73	12.26	12.89	0.003538	1.81	5.23	4.57	0.54
Morti	4.898		Lat Struct									
Morti	4.897		Lat Struct									
Morti	4	A TR30	6.76	10.49	12.39	11.56	12.46	0.001257	1.14	5.96	5.25	0.32
Morti	4	ATR200	9.40	10.49	12.76	11.75	12.83	0.001105	1.21	8.27	7.09	0.31
Morti	3	A TR30	10.35	10.16	12.15		12.21	0.000824	1.10	10.12	11.91	0.29
Morti	3	ATR200	13.56	10.16	12.39		12.45	0.000793	1.19	13.19	13.61	0.29
Morti	2.5		Culvert									
Morti	2.1	A TR30	10.35	9.46	10.75	10.39	10.99	0.006136	2.17	4.76	3.70	0.61
Morti	2.1	ATR200	14.66	9.46	10.95	10.63	11.31	0.008288	2.67	5.50	3.70	0.70
Morti	2	A TR30	10.35	9.45	10.75	10.38	10.98	0.006028	2.16	4.79	3.70	0.61
Morti	2	ATR200	14.63	9.45	10.94	10.62	11.30	0.008179	2.65	5.52	3.70	0.69
Morti	1	A TR30	10.35	9.45	10.54	10.35	10.74	0.005611	2.01	5.14	6.47	0.72
Morti	1	ATR200	14.12	9.45	10.73	10.53	10.97	0.005610	2.20	6.42	7.02	0.73

Reach	River Sta	Plan	Q US (m3/s)	Q Leaving Total (m3/s)	Q DS (m3/s)	Q Weir (m3/s)	Q Gates (m3/s)	Wr Top Wdth (m)	Weir Max Depth (m)	Weir Avg Depth (m)	Min El Weir Flow (m)	E.G. US. (m)	W.S. US. (m)	E.G. DS (m)	W.S. DS (m)
Morti	39.98	A TR30	12.63	9.81	12.73	9.81		50.96	1.56	0.75	46.15	54.22	53.15	47.74	47.71
Morti	39.98	ATR200	19.19	2.25	18.22	2.25		72.40	2.39	1.16	46.15	54.55	53.33	48.57	48.54
Morti	39.97	A TR30	12.63	10.76	12.73	10.76		66.27	1.35	0.57	46.36	54.22	53.15	47.74	47.71
Morti	39.97	ATR200	19.19	2.86	18.22	2.86		126.79	2.19	0.75	46.36	54.55	53.33	48.57	48.54
Morti	36.97	A TR30	12.51	7.87	4.51	7.87		49.65	0.49	0.18	44.73	47.03	46.52	45.28	45.22
Morti	36.97	ATR200	18.20	13.22	4.98	13.22		70.62	0.53	0.21	44.73	47.15	46.68	45.32	45.26
Morti	34.97	A TR30	4.51	1.98	2.54	1.98		22.17	0.25	0.13	43.88	44.28	44.08	44.15	44.13
Morti	34.97	ATR200	4.98	2.42	2.56	2.42		22.51	0.28	0.15	43.88	44.33	44.11	44.18	44.16
Morti	7.98	A TR30	6.00	0.00	6.77	0.00					13.91	15.70	15.38	14.19	13.63
Morti	7.98	ATR200	8.37	0.10	9.48	0.10		31.49	0.03	0.01	13.91	15.94	15.55	14.45	13.80
Morti	4.898	A TR30	6.76	0.03	10.35	0.03		5.90	0.04	0.02	12.11	12.54	12.37	12.21	12.15
Morti	4.898	ATR200	9.47	2.79	13.56	2.79		38.50	0.28	0.11	12.11	12.89	12.73	12.45	12.39
Morti	4.897	A TR30	6.76	0.00	10.35	0.00					12.35	12.54	12.37	12.21	12.15
Morti	4.897	ATR200	9.47	0.01	13.56	0.01		2.59	0.04	0.02	12.35	12.89	12.73	12.45	12.39

Reach	River Sta	Plan	Q US (m3/s)	Q Leaving Total (m3/s)	Q DS (m3/s)	Q Weir (m3/s)	Q Gates (m3/s)	Wr Top Wdth (m)	Weir Max Depth (m)	Weir Avg Depth (m)	Min El Weir Flow (m)	E.G. US. (m)	W.S. US. (m)	E.G. DS (m)	W.S. DS (m)
Morti	39.98	A TR30	12.63	9.81	12.73	9.81		50.96	1.56	0.75	46.15	54.22	53.15	47.74	47.71
Morti	39.98	ATR200	19.19	2.25	18.22	2.25		72.40	2.39	1.16	46.15	54.55	53.33	48.57	48.54
Morti	39.97	A TR30	12.63	10.76	12.73	10.76		66.27	1.35	0.57	46.36	54.22	53.15	47.74	47.71
Morti	39.97	ATR200	19.19	2.86	18.22	2.86		126.79	2.19	0.75	46.36	54.55	53.33	48.57	48.54
Morti	36.97	A TR30	12.51	7.87	4.51	7.87		49.65	0.49	0.18	44.73	47.03	46.52	45.28	45.22
Morti	36.97	ATR200	18.20	13.22	4.98	13.22		70.62	0.53	0.21	44.73	47.15	46.68	45.32	45.26
Morti	34.97	A TR30	4.51	1.98	2.54	1.98		22.17	0.25	0.13	43.88	44.28	44.08	44.15	44.13
Morti	34.97	ATR200	4.98	2.42	2.56	2.42		22.51	0.28	0.15	43.88	44.33	44.11	44.18	44.16
Morti	7.98	A TR30	6.00	0.00	6.77	0.00					13.91	15.70	15.38	14.19	13.63
Morti	7.98	ATR200	8.37	0.10	9.48	0.10		31.49	0.03	0.01	13.91	15.94	15.55	14.45	13.80
Morti	4.898	A TR30	6.76	0.03	10.35	0.03		5.90	0.04	0.02	12.11	12.54	12.37	12.21	12.15
Morti	4.898	ATR200	9.47	2.79	13.56	2.79		38.50	0.28	0.11	12.11	12.89	12.73	12.45	12.39
Morti	4.897	A TR30	6.76	0.00	10.35	0.00					12.35	12.54	12.37	12.21	12.15
Morti	4.897	ATR200	9.47	0.01	13.56	0.01		2.59	0.04	0.02	12.35	12.89	12.73	12.45	12.39

Fosso Vallecorsa e fosso Mozzicone

Stato attuale



Note: of the XS's are Geo-Referenced (Geo-Ref user entered XS, Geo-Ref interpolated XS, Non Geo-Ref user entered XS, Non Geo-Ref interpolated XS)

1 cm Horiz. = 82 m 1 cm Vert. = 67 m

1) A TR 200 2) A TR 30

mozzicone mozzicone

N.B. in grigio sono indicati gli sfioratori laterali in destra idrografica

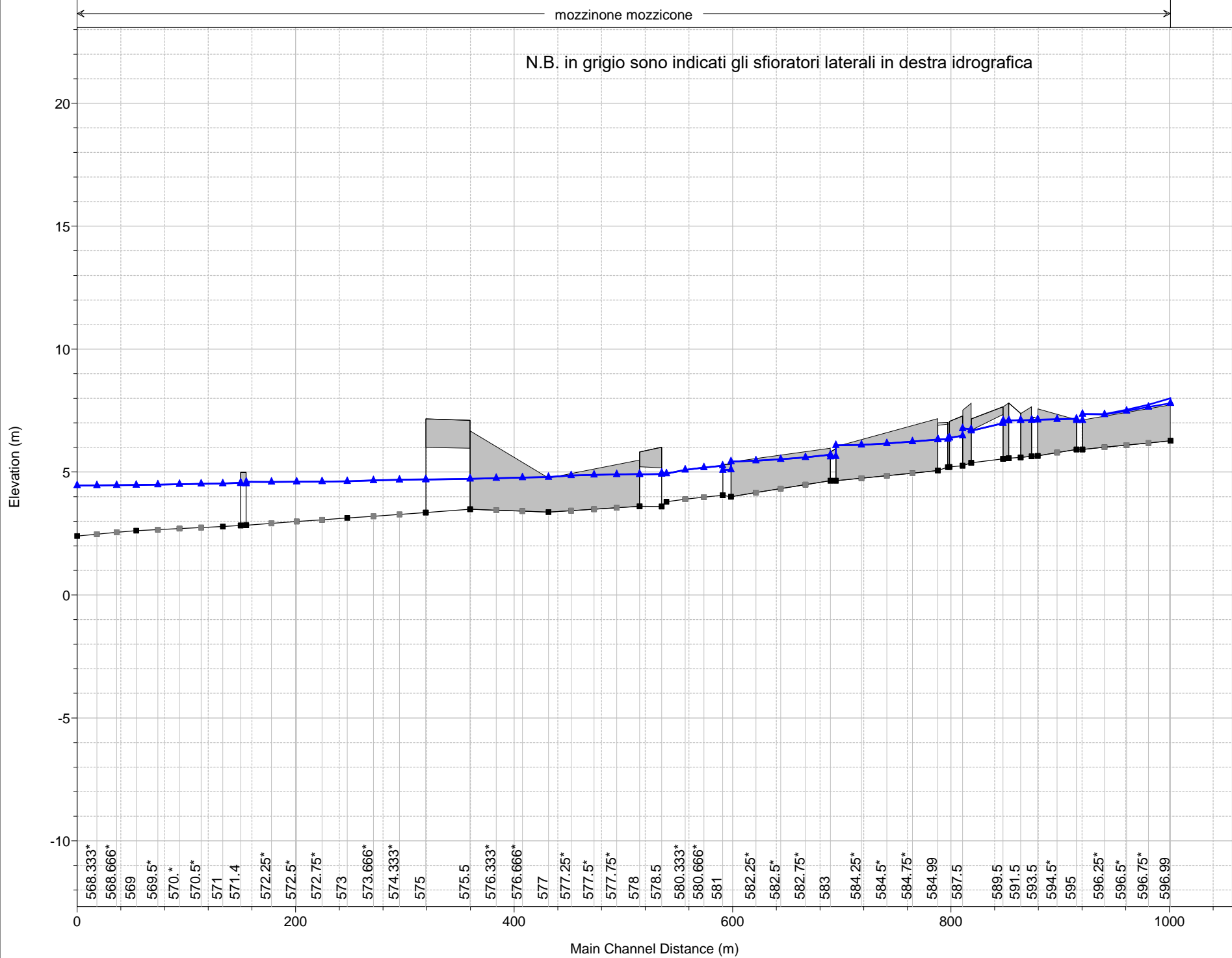

Legend

- WS Max WS - A TR 200
- WS Max WS - A TR 30
- Ground

1 cm Horiz. = 45 m 1 cm Vert. = 2 m

1) A TR 200 2) A TR 30

mozzicone mozzicone

N.B. in grigio sono indicati gli sfioratori laterali in sinistra idrografica

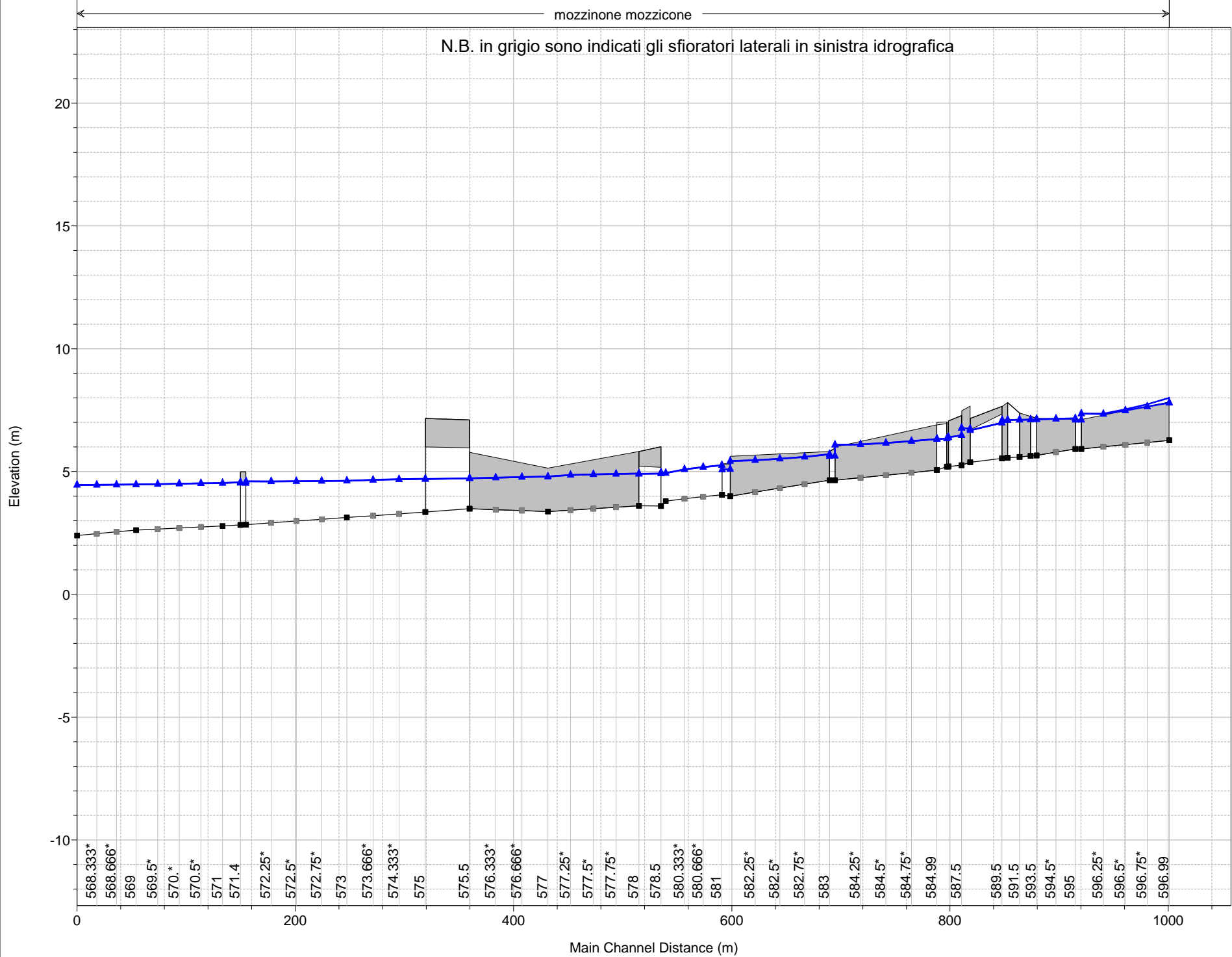

Legend

- WS Max WS - A TR 200
- WS Max WS - A TR 30
- Ground

1 cm Horiz. = 45 m 1 cm Vert. = 2 m

1) A TR 200 2) A TR 30
 River = mozzicone Reach = mozzicone RS = 597 Sez. 28

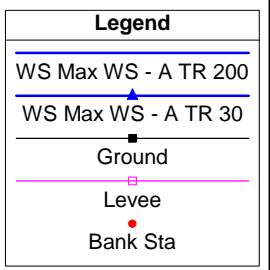
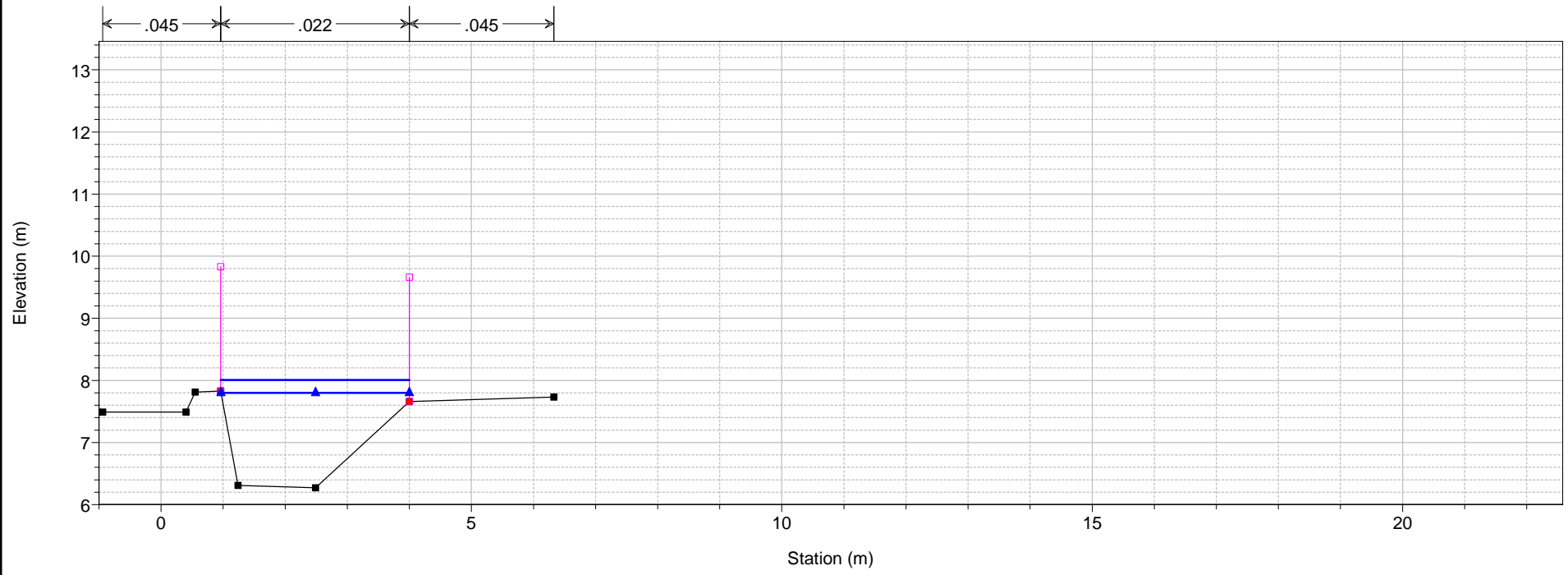

1) A TR 200 2) A TR 30
 River = mozzicone Reach = mozzicone RS = 596.99 Sez. 28

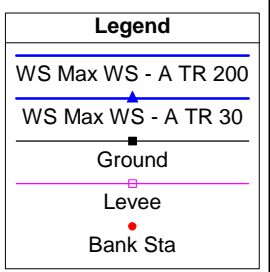
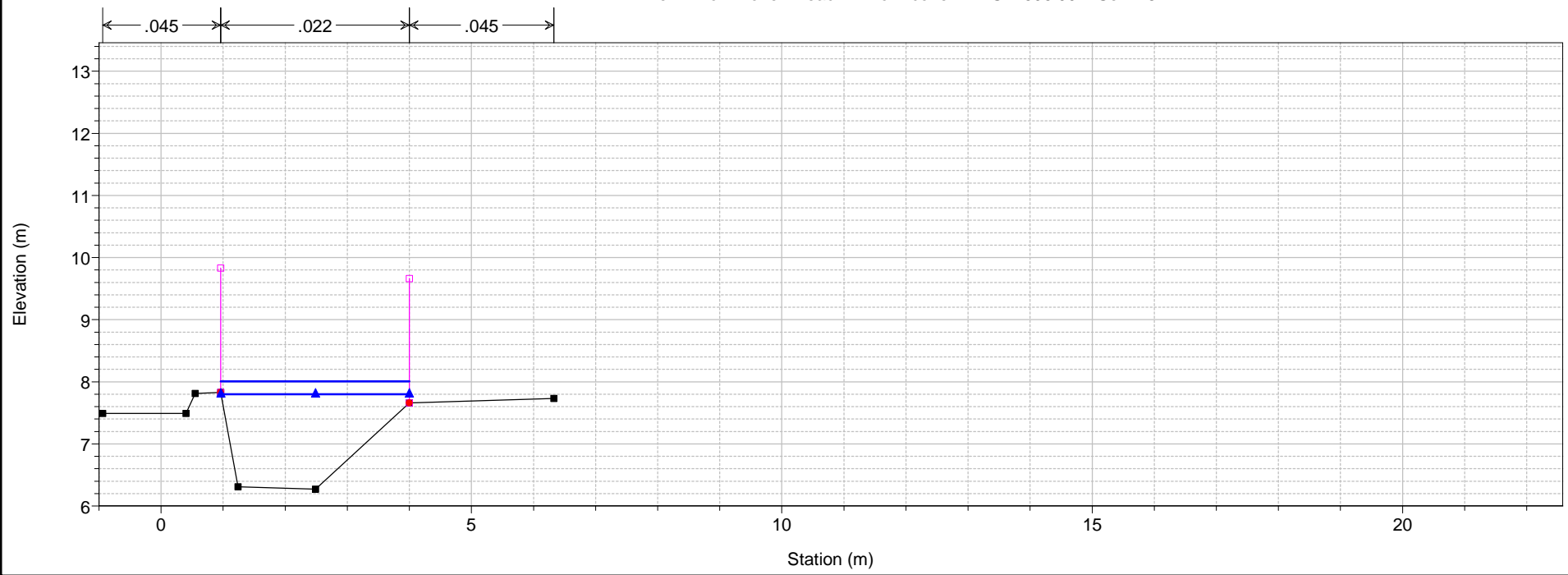

1 cm Horiz. = 1 m 1 cm Vert. = 1 m

1) A TR 200 2) A TR 30
River = mozzicone Reach = mozzicone RS = 596 Sez. 27

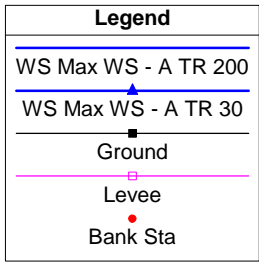
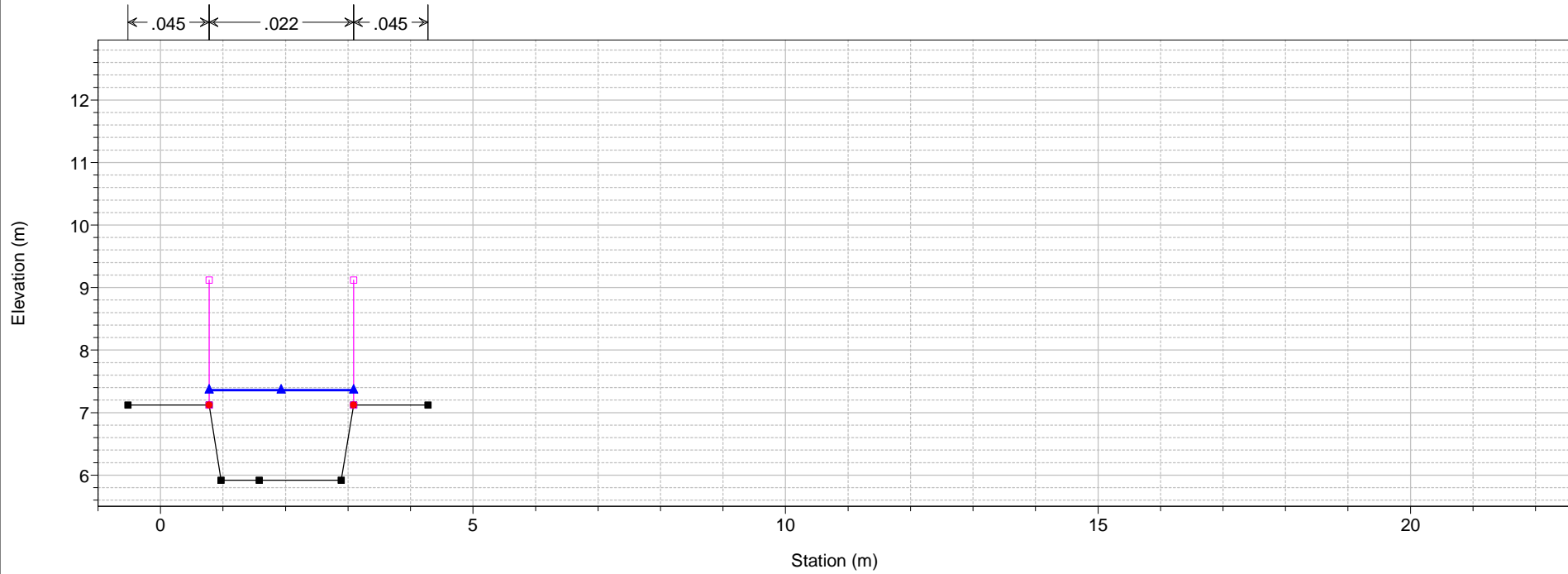

1) A TR 200 2) A TR 30
River = mozzicone Reach = mozzicone RS = 595.5 BR

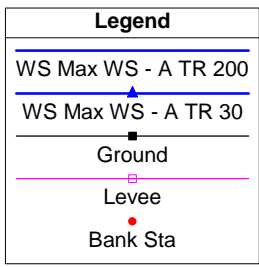
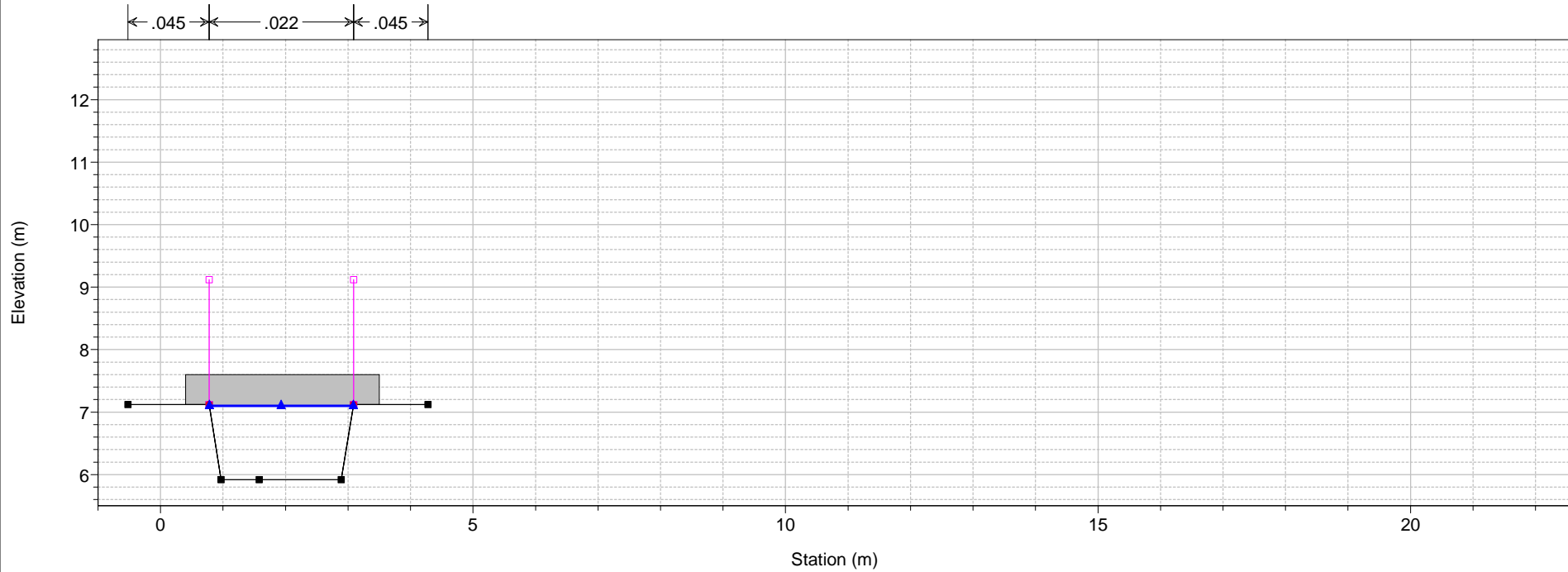

1 cm Horiz. = 1 m 1 cm Vert. = 1 m

1) A TR 200 2) A TR 30
River = mozzicone Reach = mozzicone RS = 595.5 BR

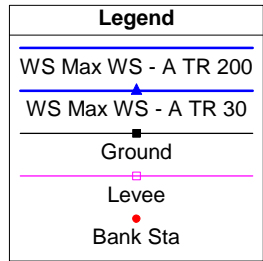
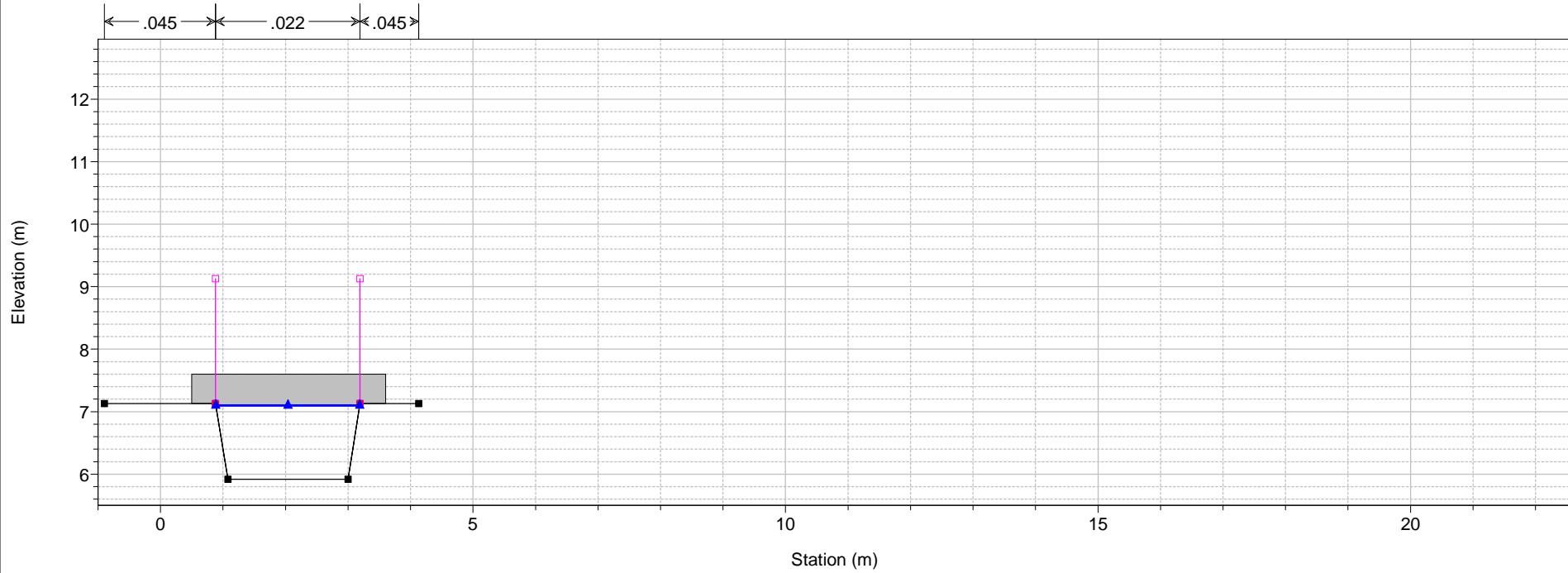

1) A TR 200 2) A TR 30
River = mozzicone Reach = mozzicone RS = 595 Sez. 26

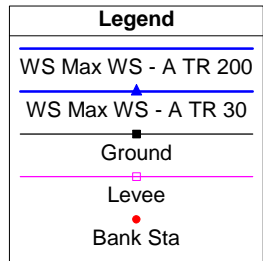
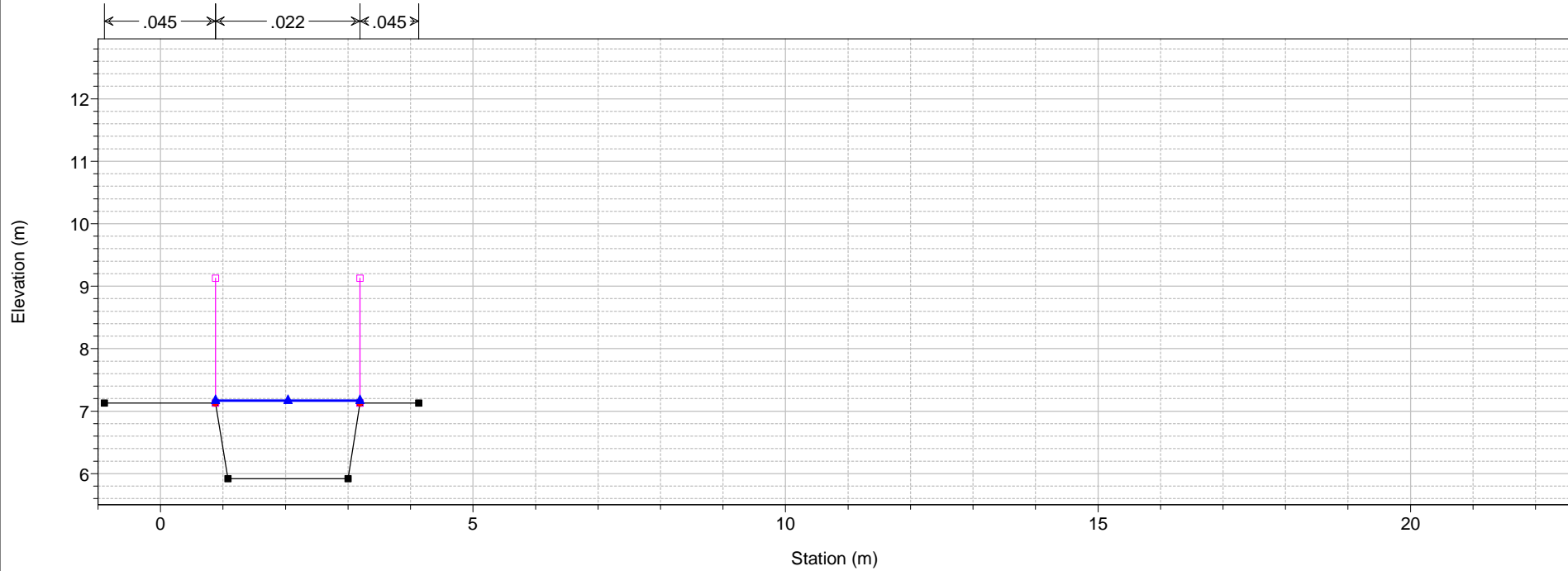

1) A TR 200 2) A TR 30
 River = mozzinone Reach = mozzicone RS = 594 Sez. 25

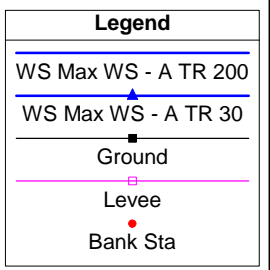
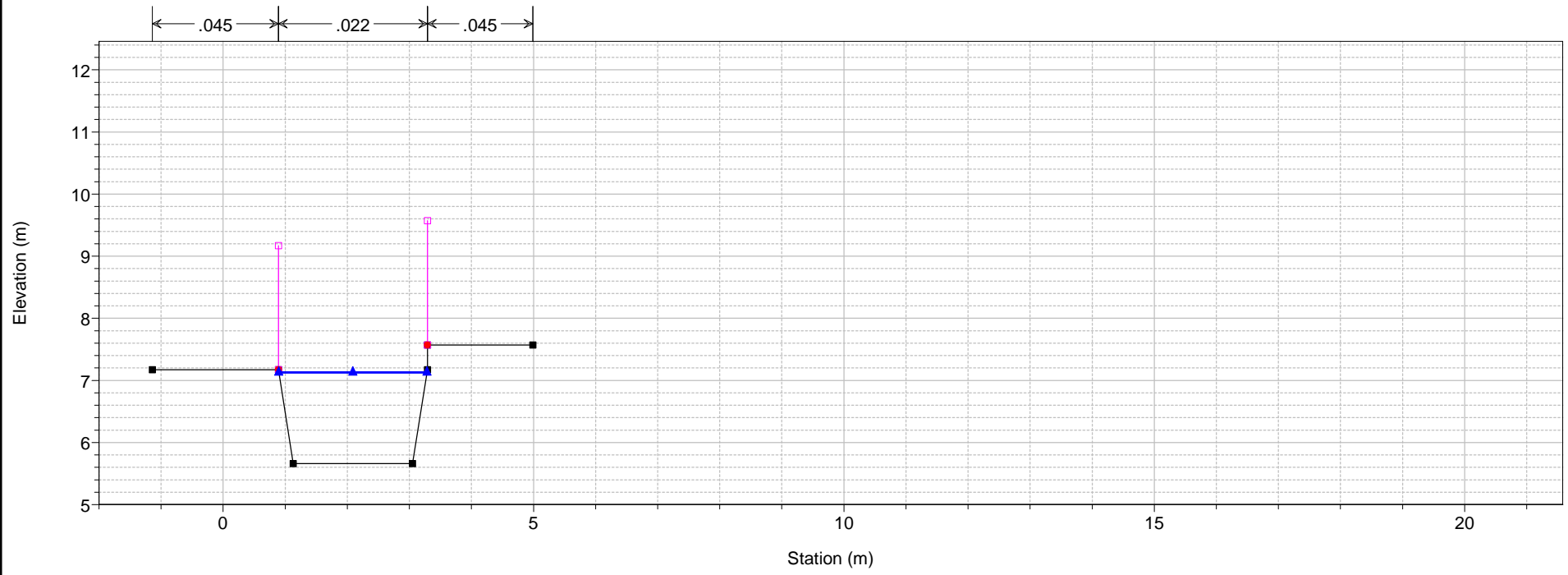

1) A TR 200 2) A TR 30
 River = mozzinone Reach = mozzicone RS = 593.5 BR

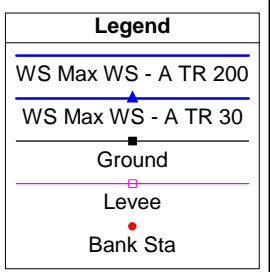
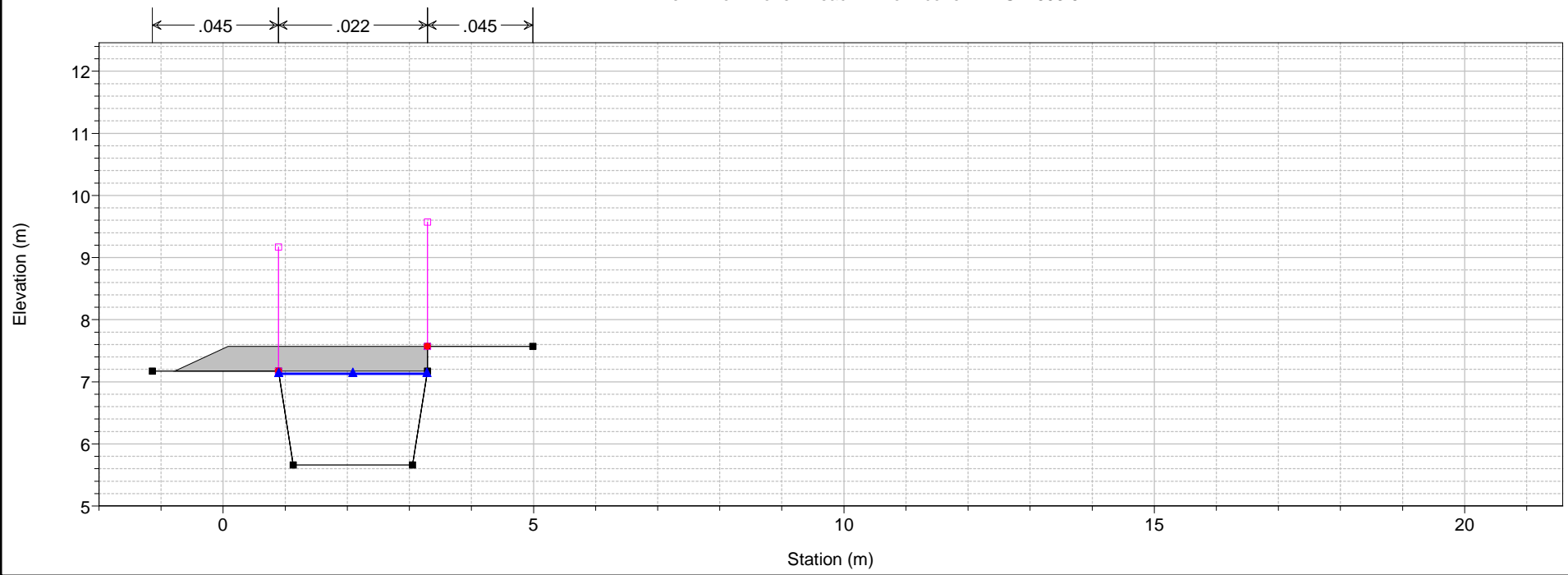

1 cm Horiz. = 1 m 1 cm Vert. = 1 m

1) A TR 200 2) A TR 30
 River = mozzicone Reach = mozzicone RS = 593.5 BR

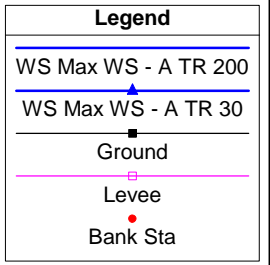
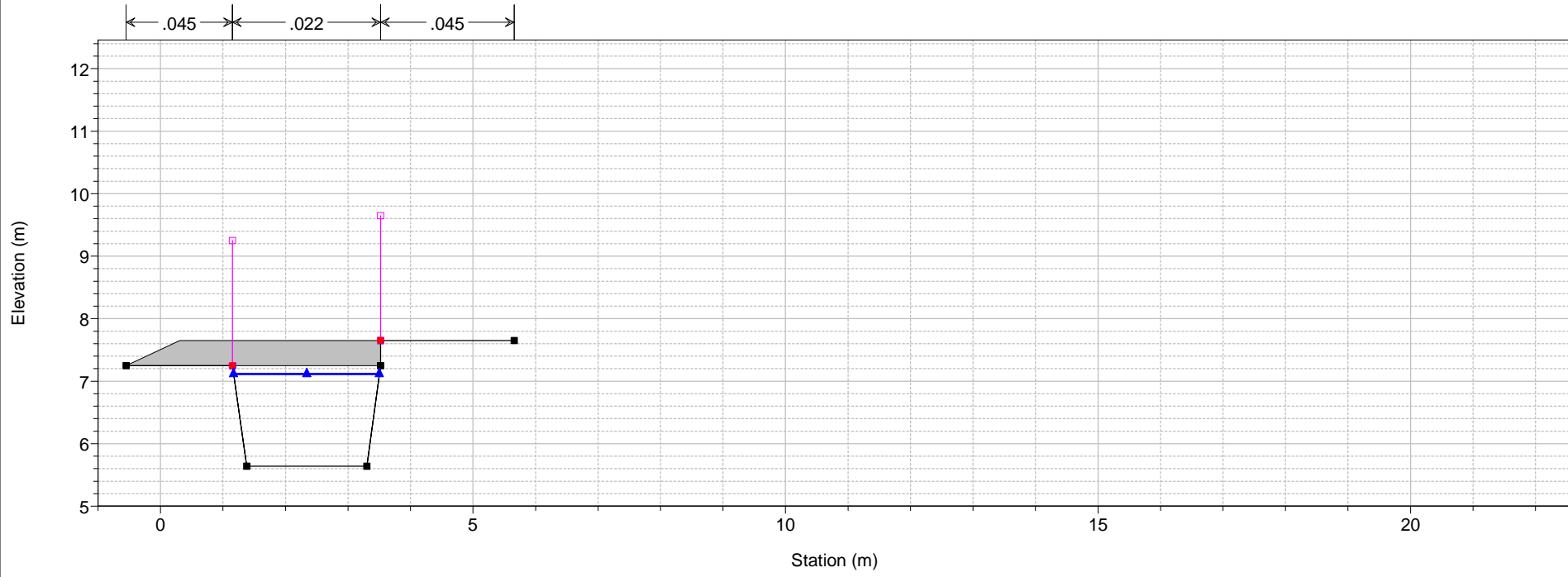

1) A TR 200 2) A TR 30
 River = mozzicone Reach = mozzicone RS = 593 Sez. 24

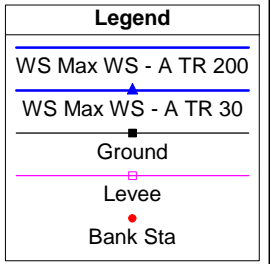
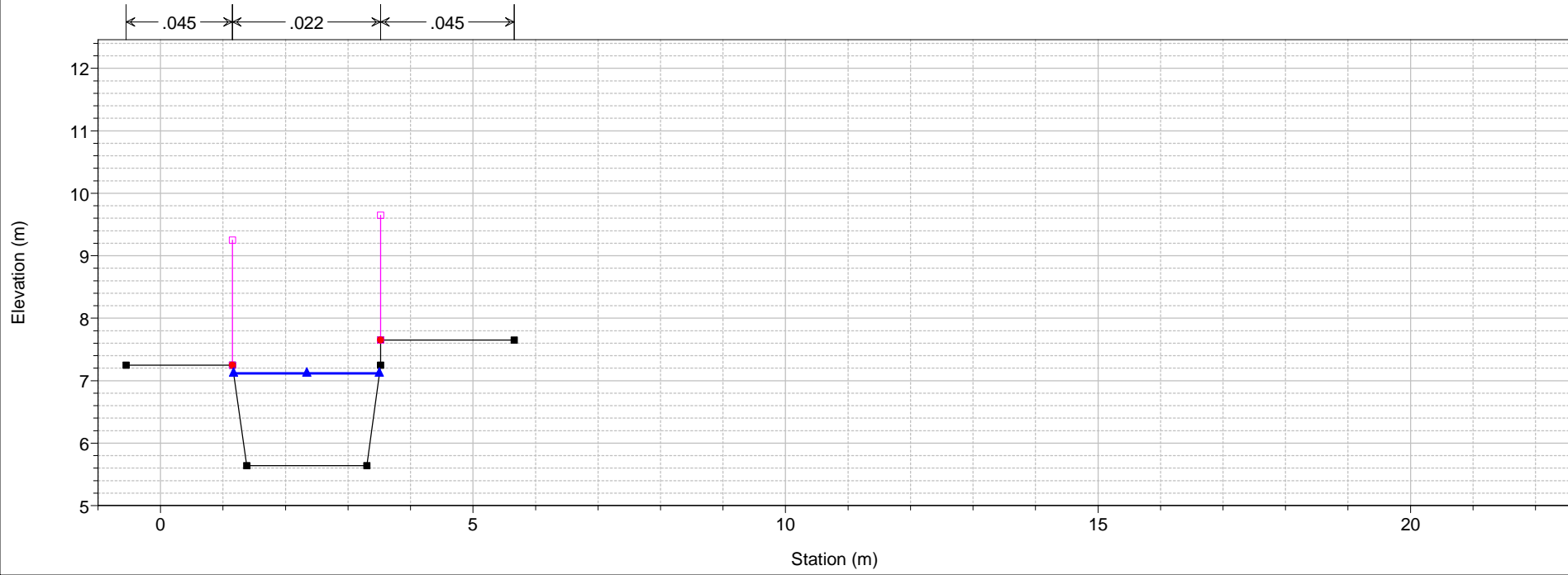

1 cm Horiz. = 1 m 1 cm Vert. = 1 m

1) A TR 200 2) A TR 30
 River = mozzicone Reach = mozzicone RS = 592 Sez. 23

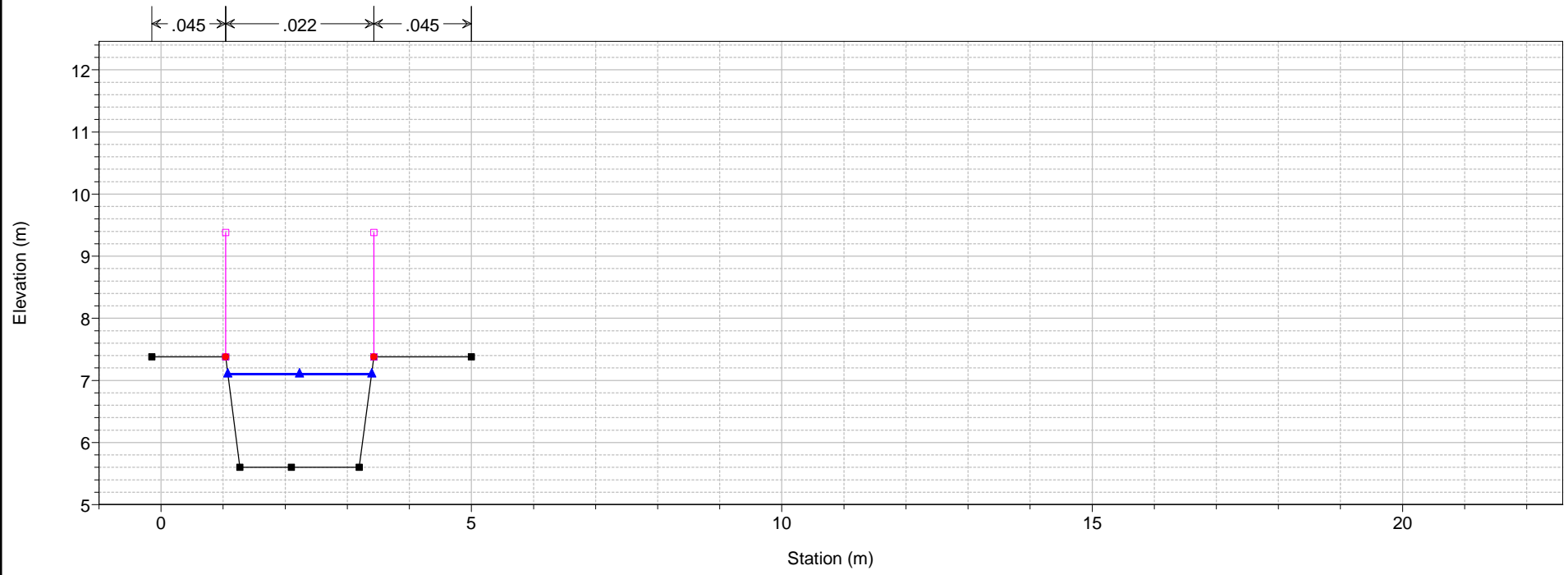

1) A TR 200 2) A TR 30
 River = mozzicone Reach = mozzicone RS = 591.5 BR

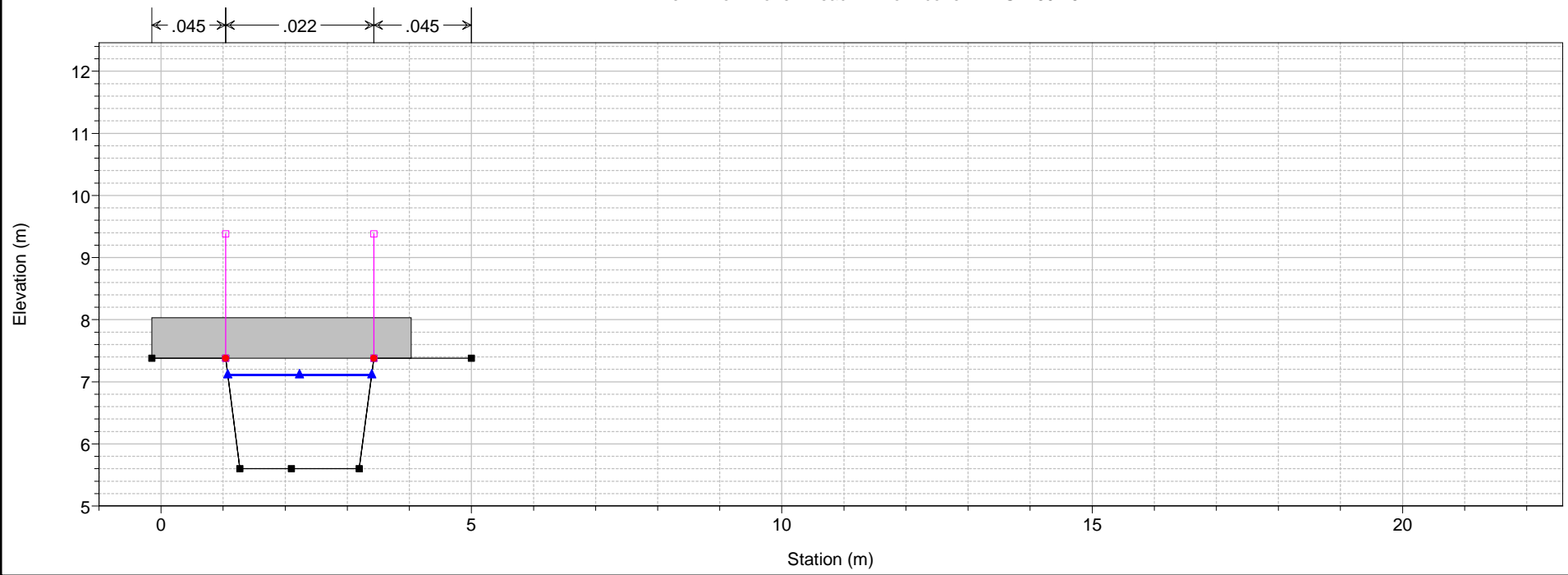

1 cm Horiz. = 1 m 1 cm Vert. = 1 m

1) A TR 200 2) A TR 30

River = mozzinone Reach = mozzicone RS = 591.5 BR

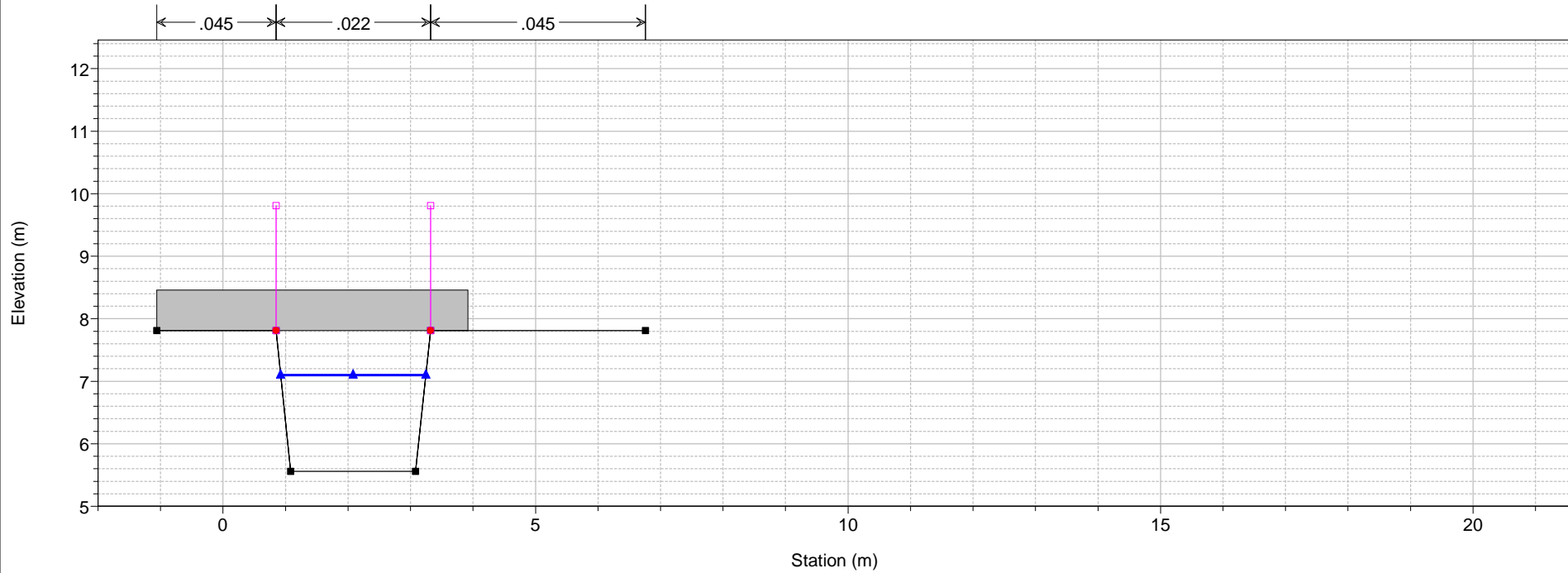

1) A TR 200 2) A TR 30

River = mozzinone Reach = mozzicone RS = 591 Sez. 22

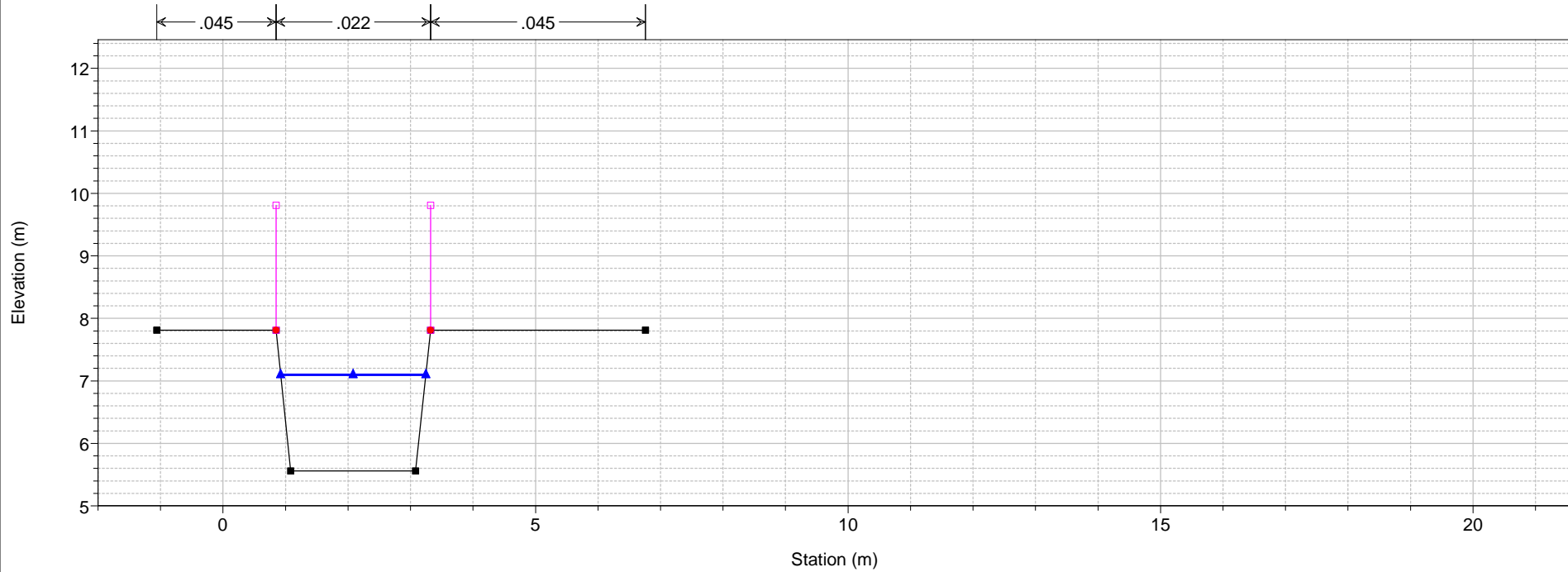

1 cm Horiz. = 1 m 1 cm Vert. = 1 m

1) A TR 200 2) A TR 30
River = mozzicone Reach = mozzicone RS = 590 Sez. 21

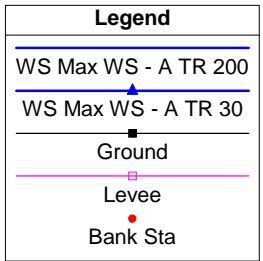
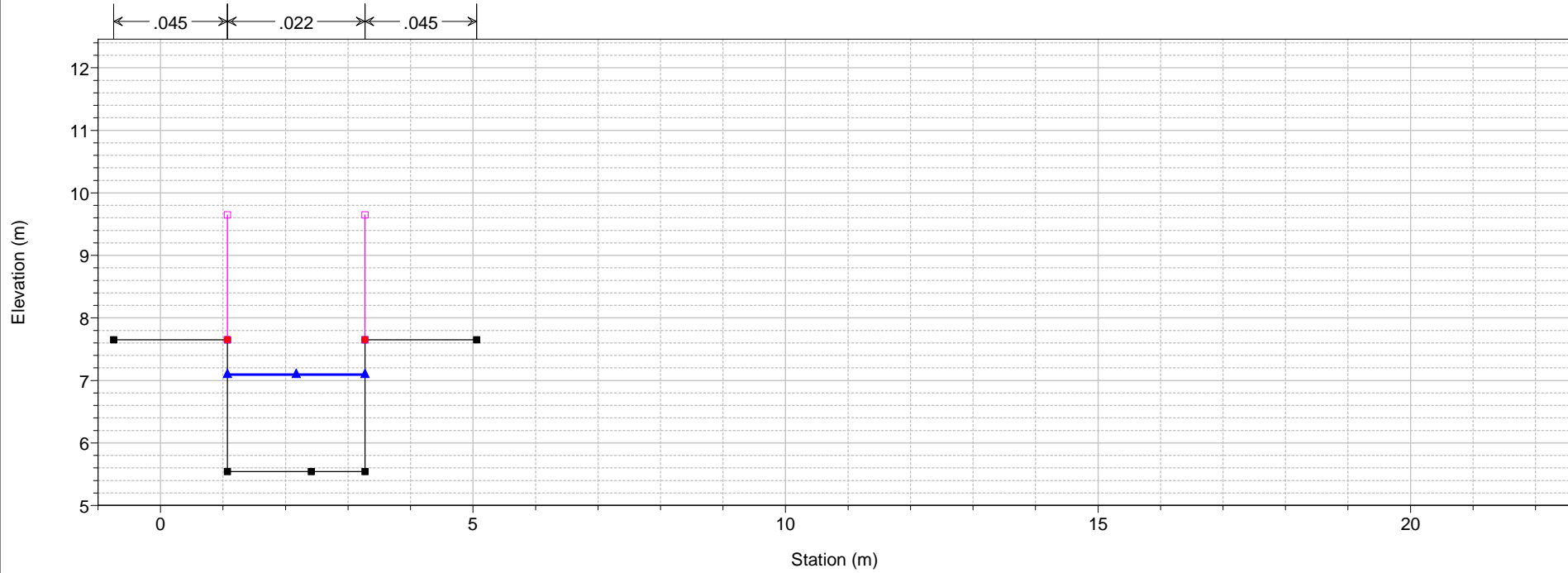

1) A TR 200 2) A TR 30
River = mozzicone Reach = mozzicone RS = 589.5 BR

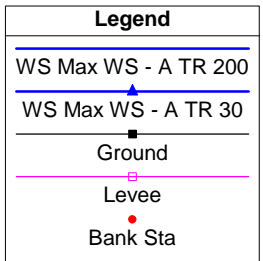
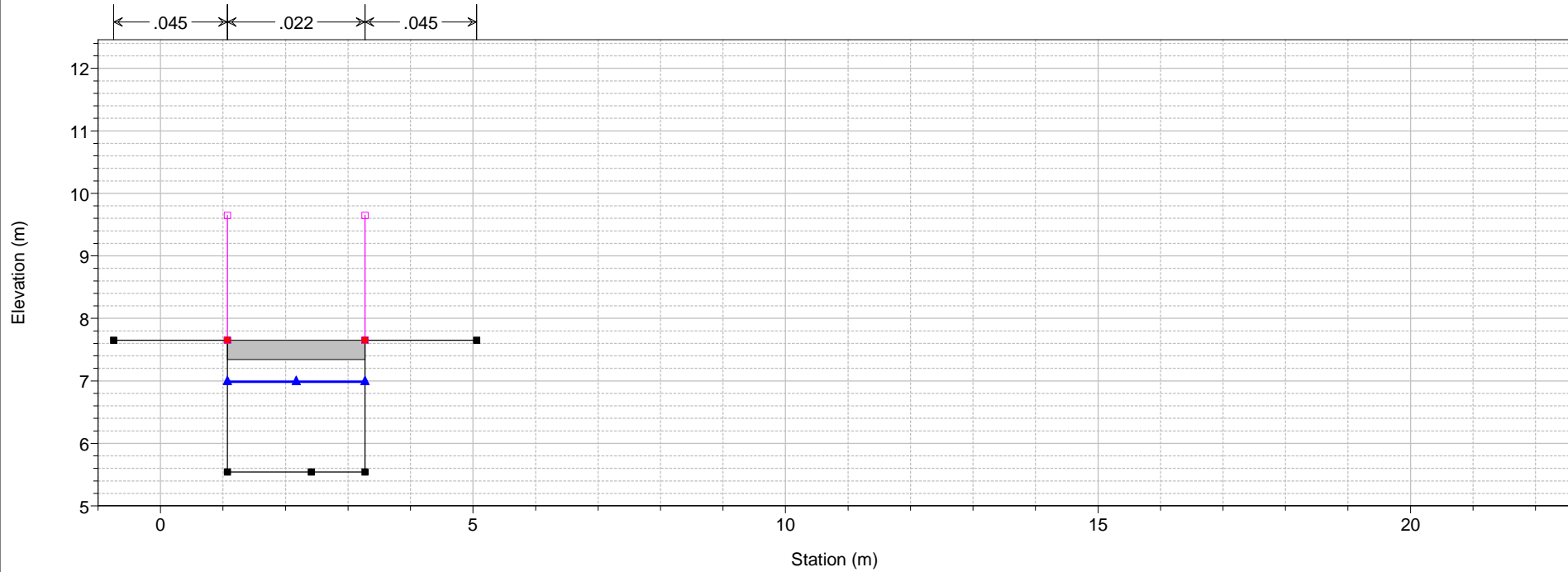

1) A TR 200 2) A TR 30
River = mozzicone Reach = mozzicone RS = 589.5 BR

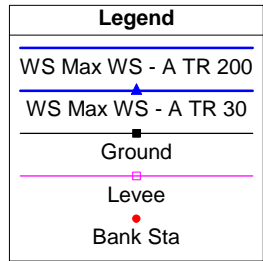
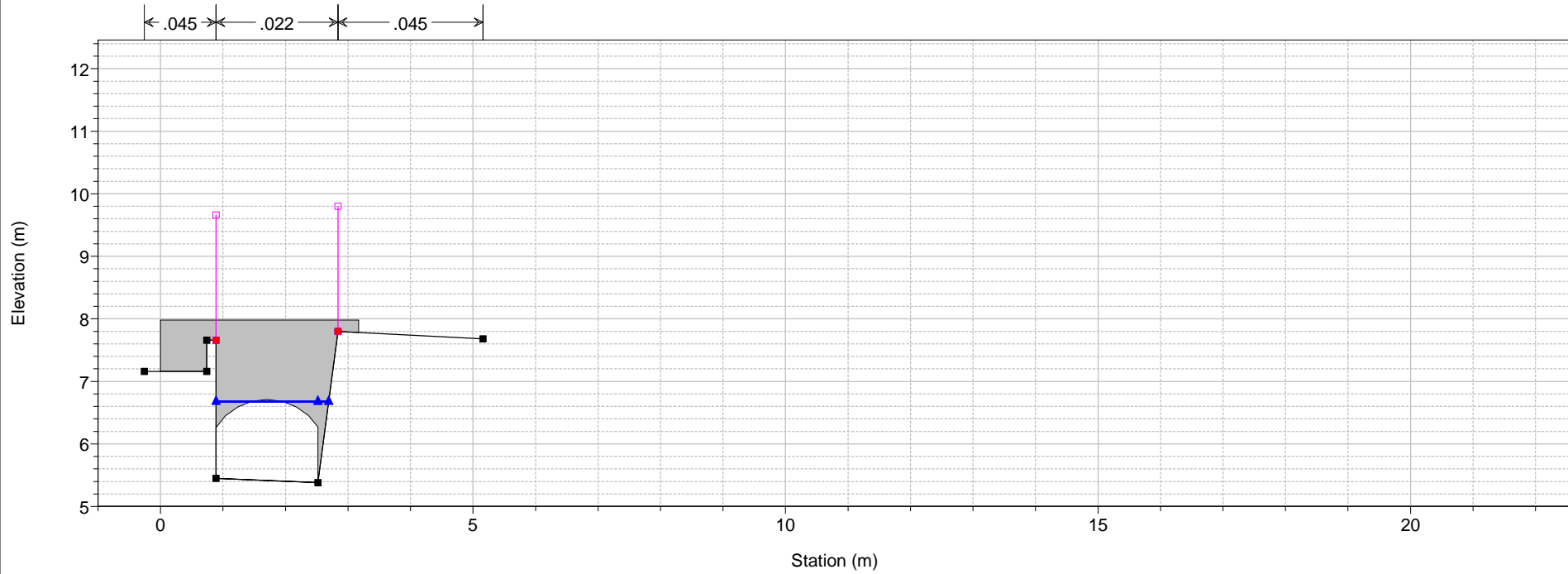

1) A TR 200 2) A TR 30
River = mozzicone Reach = mozzicone RS = 589 Sez. 20

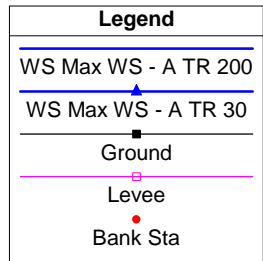
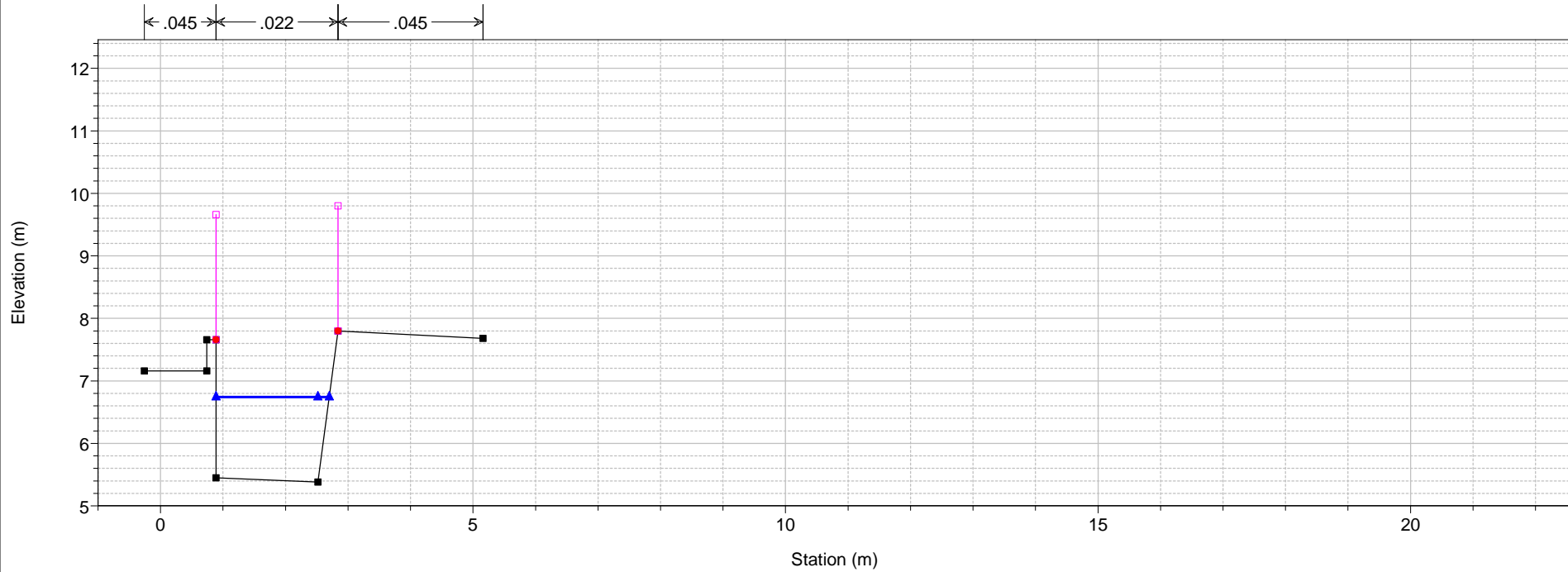

1) A TR 200 2) A TR 30
River = mozzicone Reach = mozzicone RS = 588 Sez.19

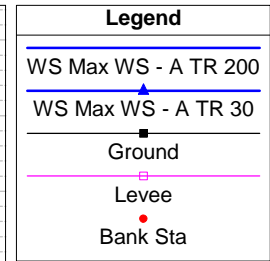
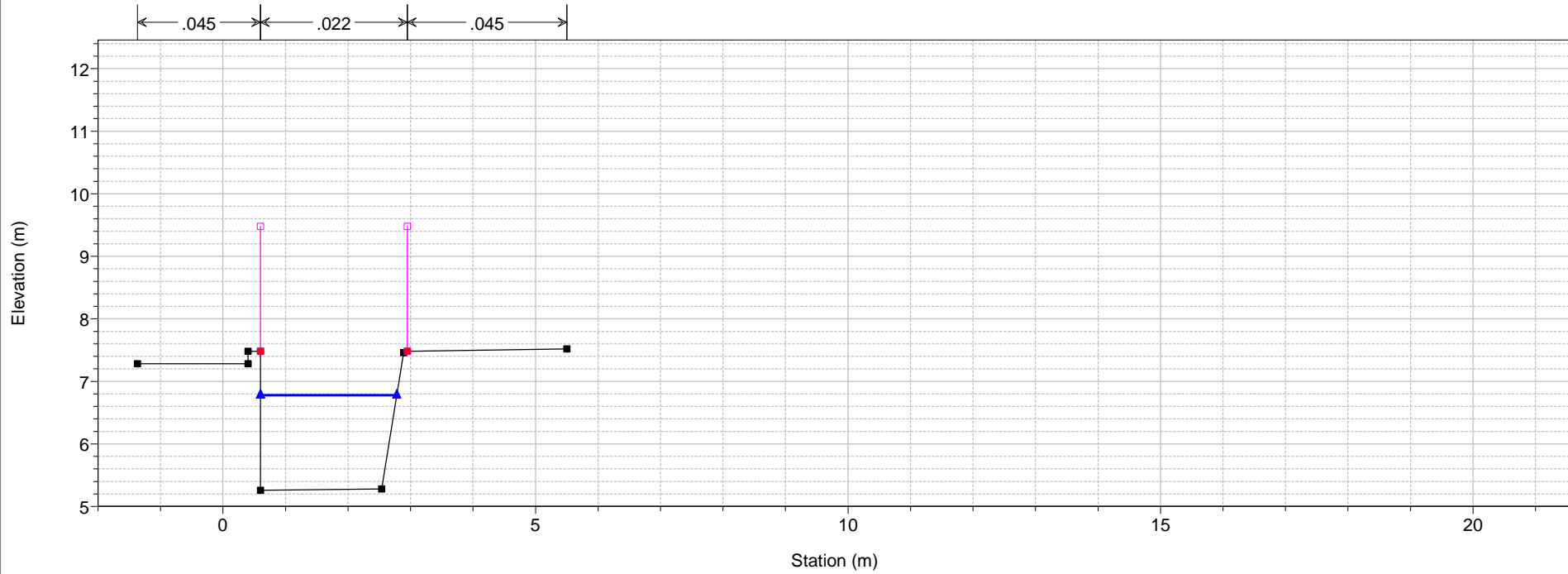

1) A TR 200 2) A TR 30
River = mozzicone Reach = mozzicone RS = 587.5 BR

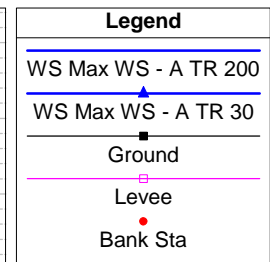
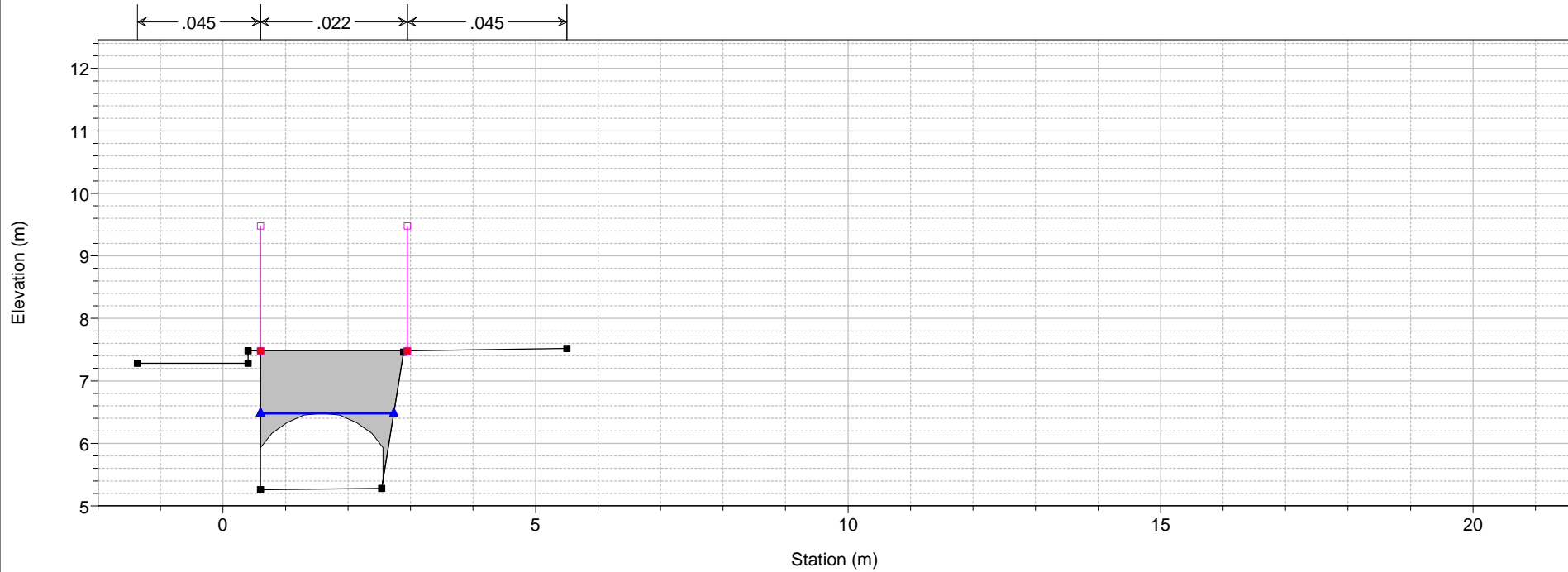

1 cm Horiz. = 1 m 1 cm Vert. = 1 m

1) A TR 200 2) A TR 30
 River = mozzinone Reach = mozzicone RS = 587.5 BR

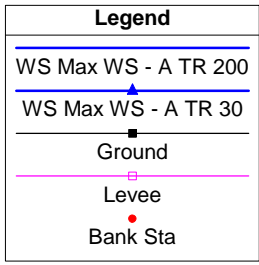
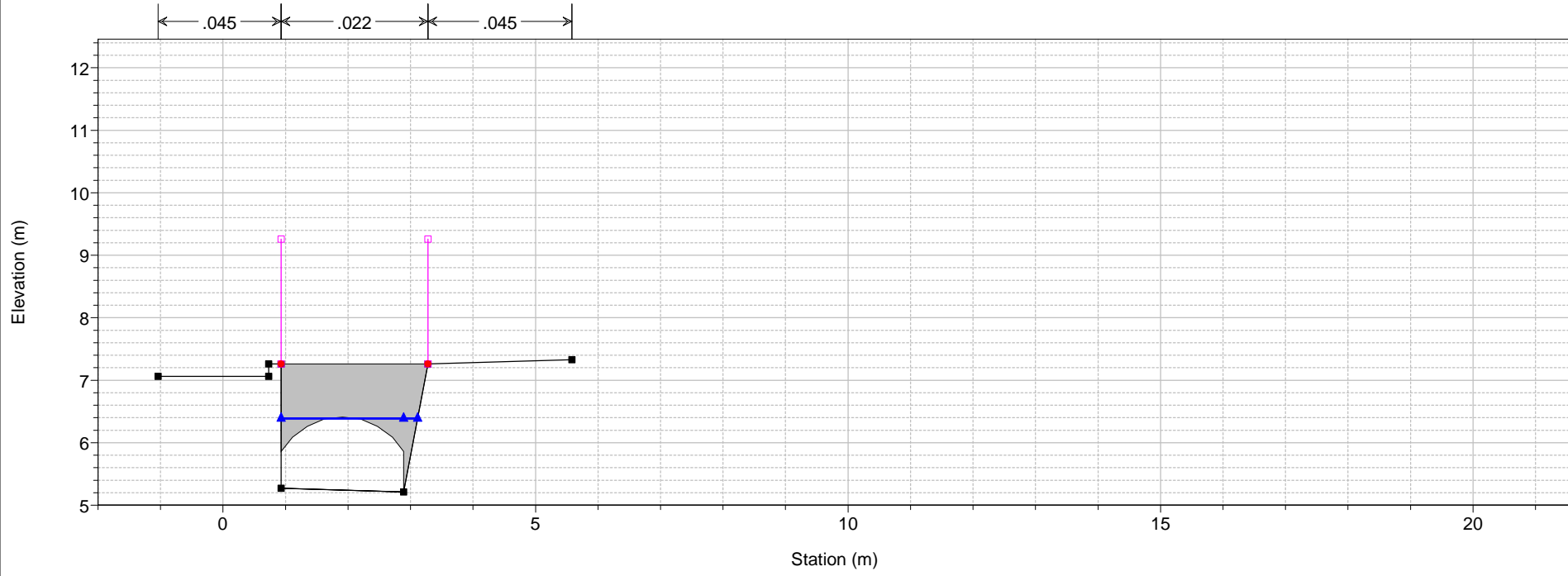

1) A TR 200 2) A TR 30
 River = mozzinone Reach = mozzicone RS = 587 Sez. 18

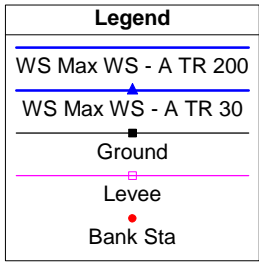
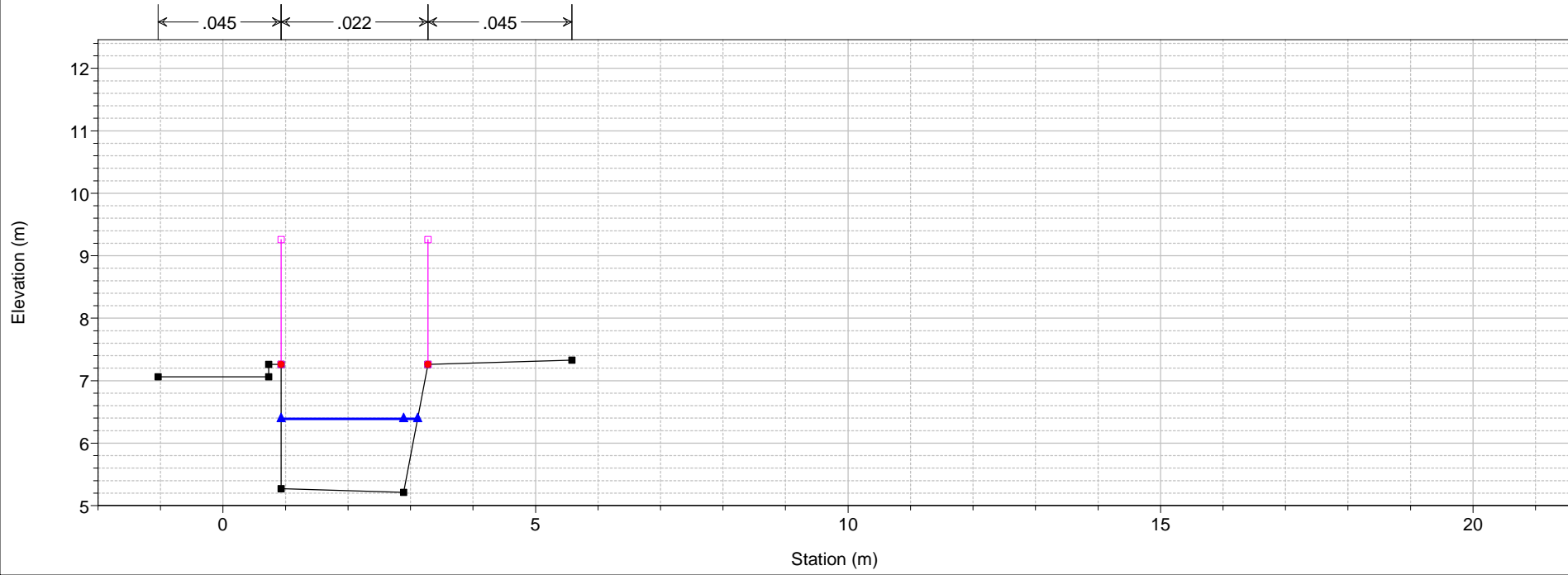

1 cm Horiz. = 1 m 1 cm Vert. = 1 m

1) A TR 200 2) A TR 30
 River = mozzicone Reach = mozzicone RS = 586 Sez. 17

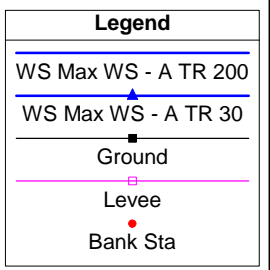
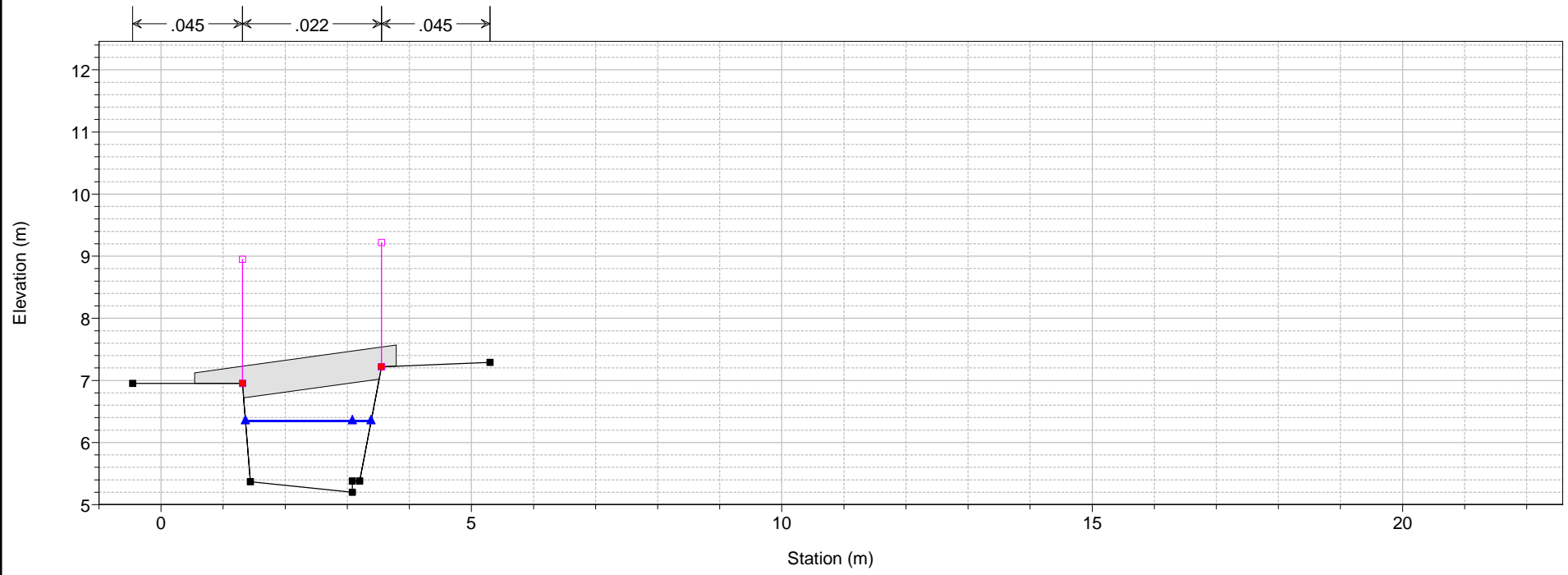

1) A TR 200 2) A TR 30
 River = mozzicone Reach = mozzicone RS = 585 Sez. 16

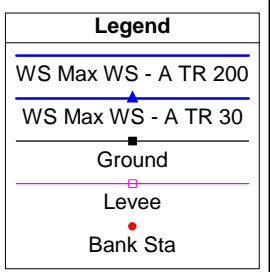
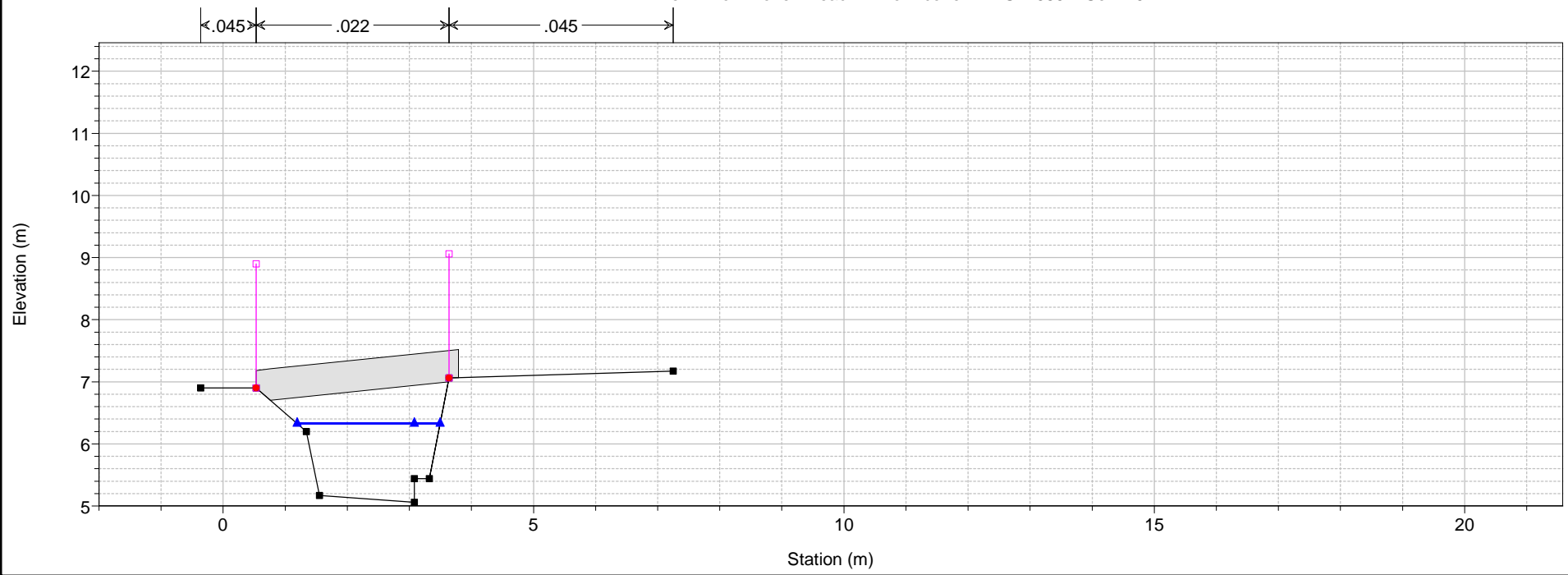

1 cm Horiz. = 1 m 1 cm Vert. = 1 m

1) A TR 200 2) A TR 30
 River = mozzicone Reach = mozzicone RS = 584.99 Sez. 16

←.045→ .022 ←.045→

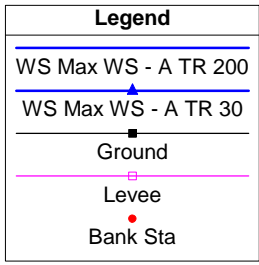
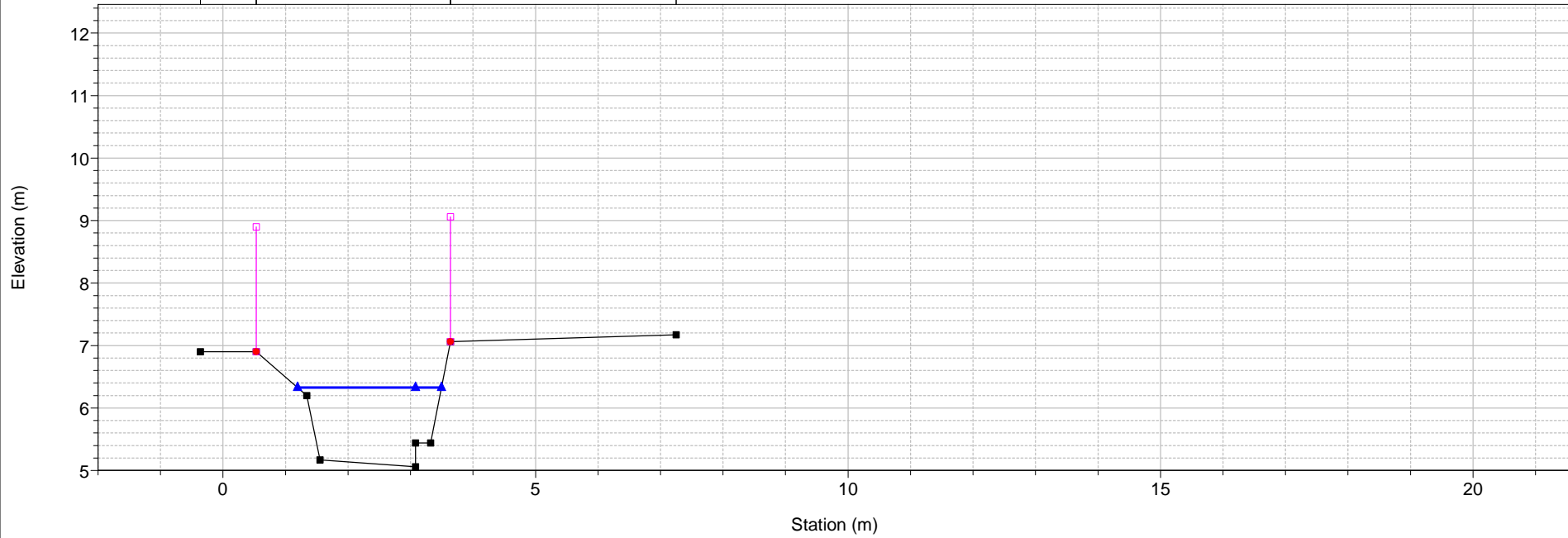

1) A TR 200 2) A TR 30
 River = mozzicone Reach = mozzicone RS = 584 Sez. 15

←.045→ .03 ←.045→

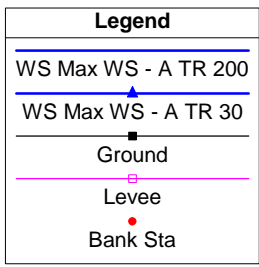
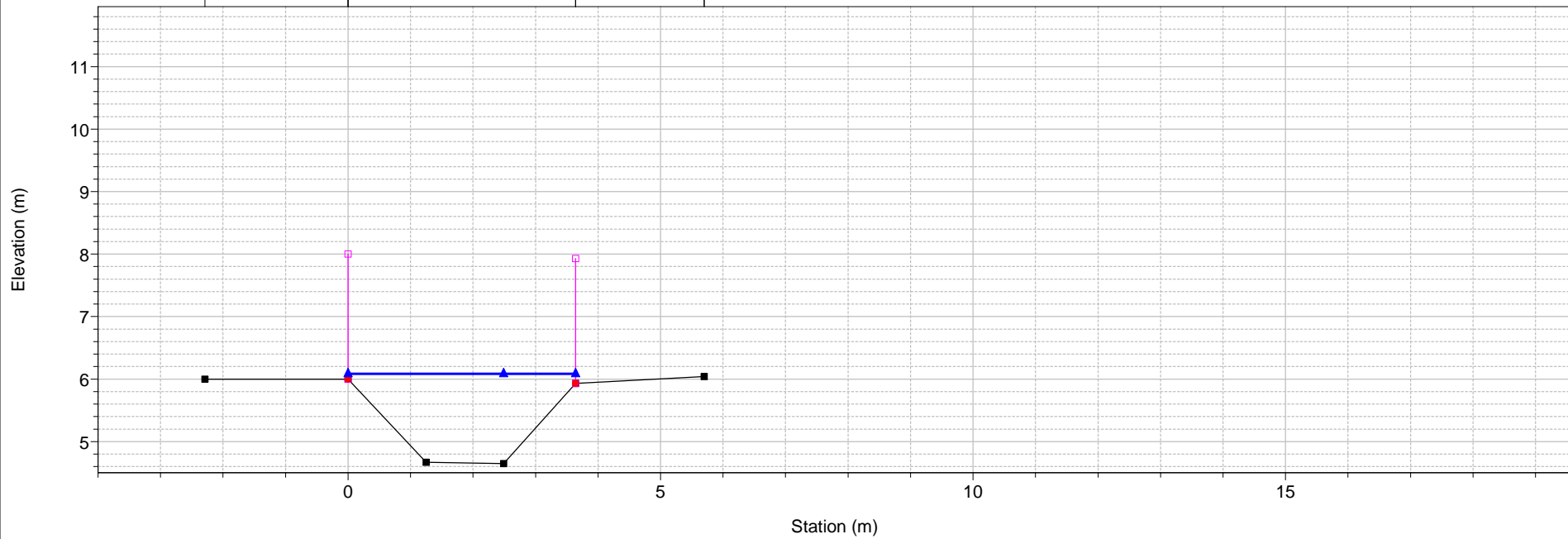

1) A TR 200 2) A TR 30

River = mozzicone Reach = mozzicone RS = 583.5 BR

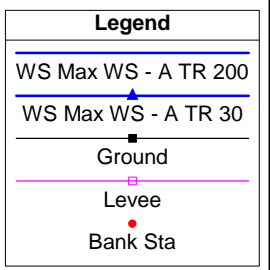
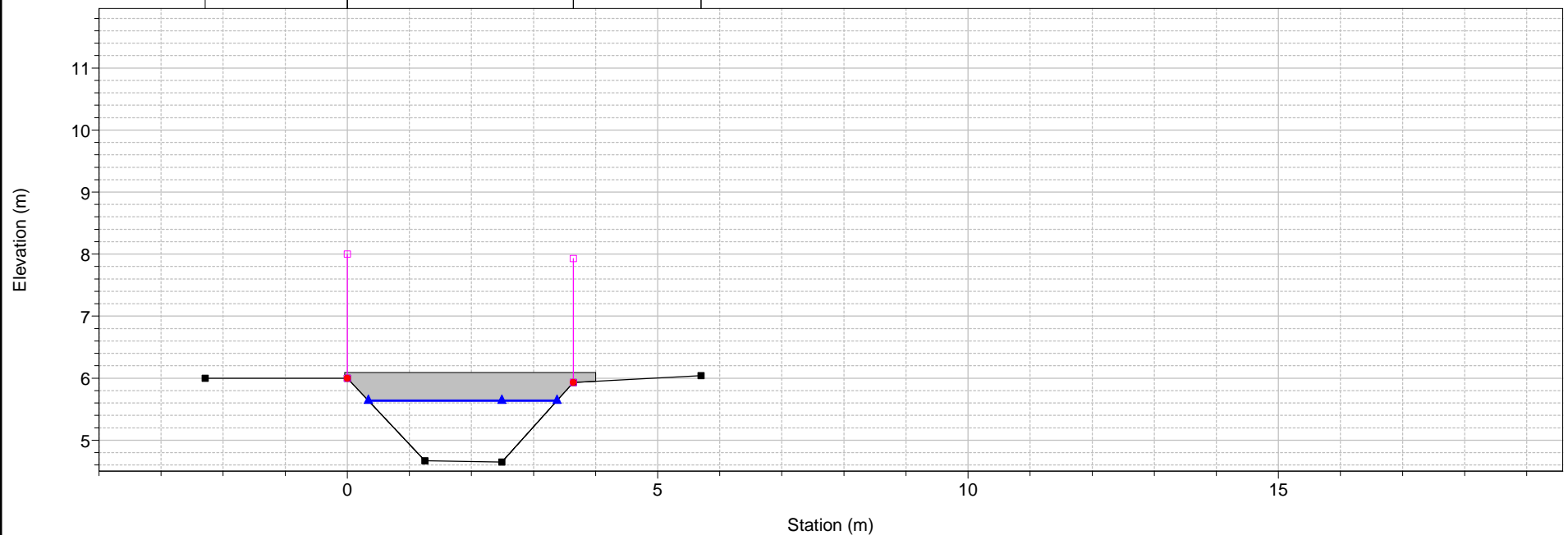
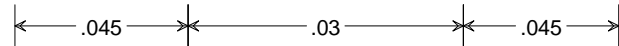

1) A TR 200 2) A TR 30

River = mozzicone Reach = mozzicone RS = 583.5 BR

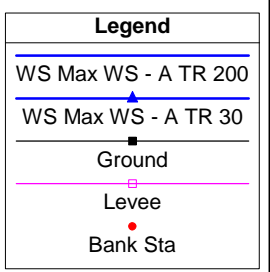
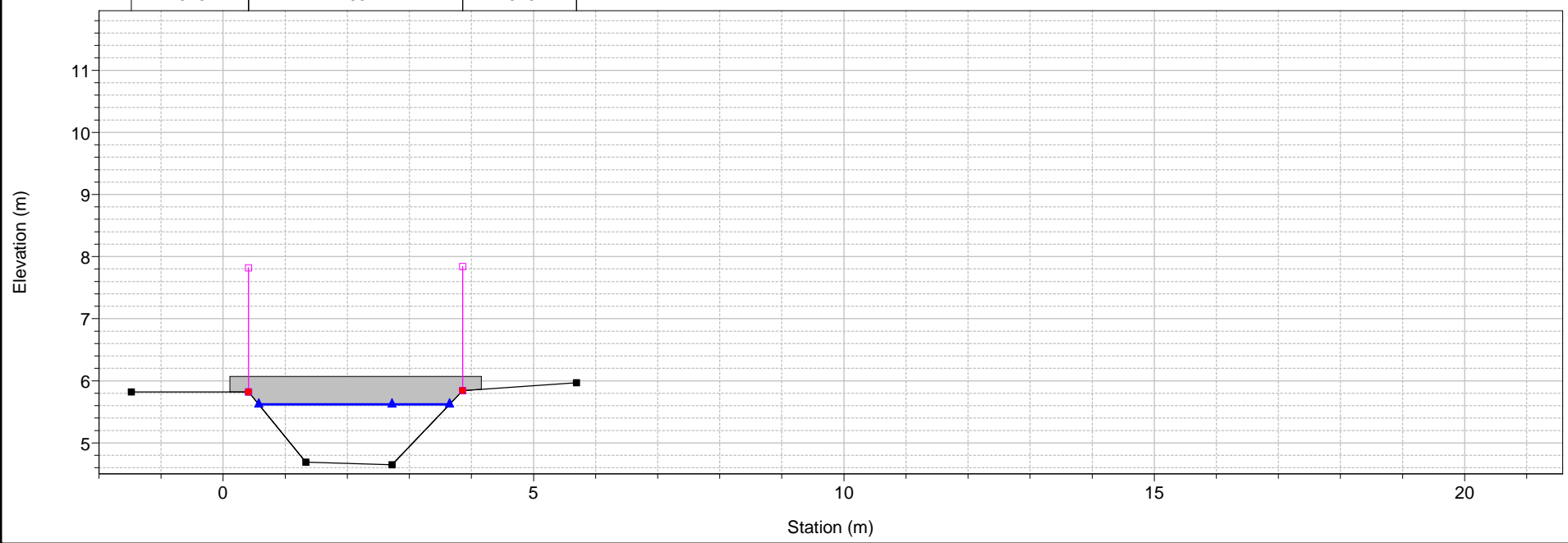
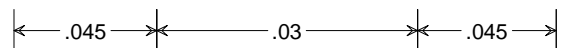

1 cm Horiz. = 1 m 1 cm Vert. = 1 m

1) A TR 200 2) A TR 30
 River = mozzicone Reach = mozzicone RS = 583 Sez. 14

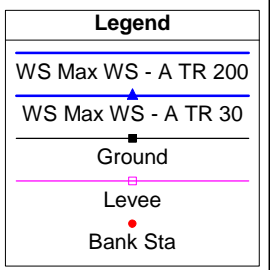
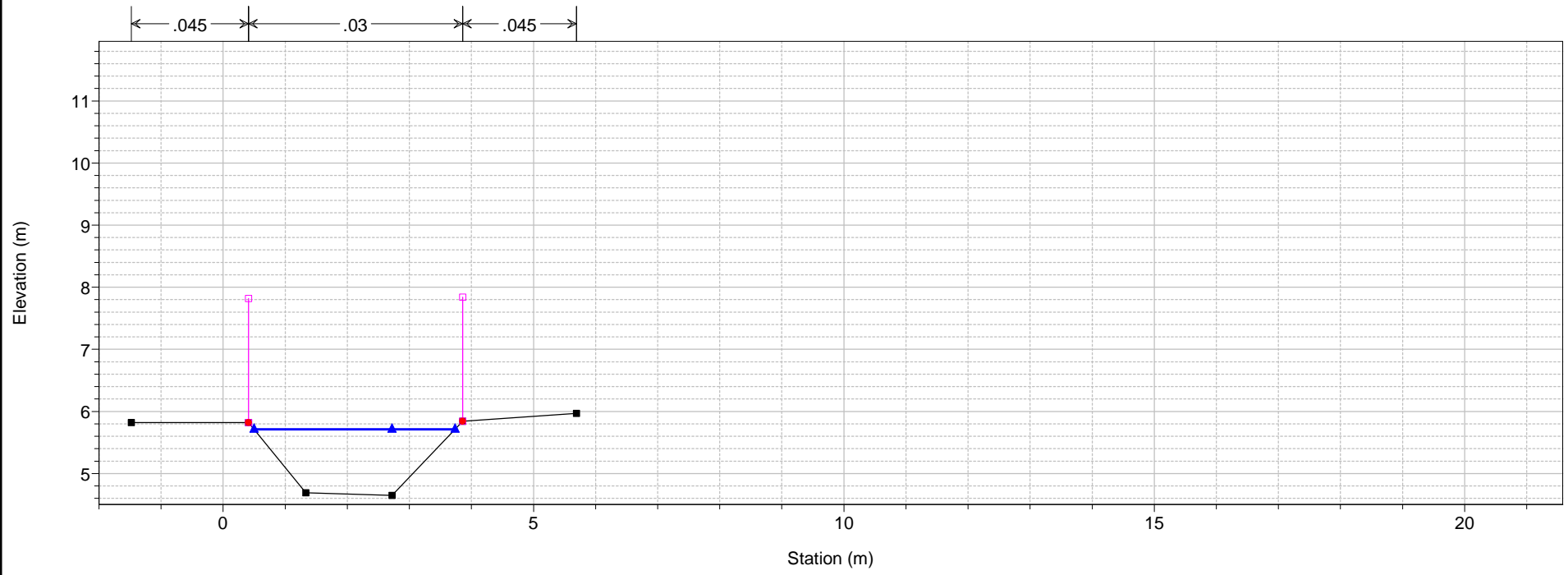

1) A TR 200 2) A TR 30
 River = mozzicone Reach = mozzicone RS = 582 Sez. 13

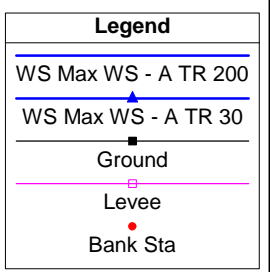
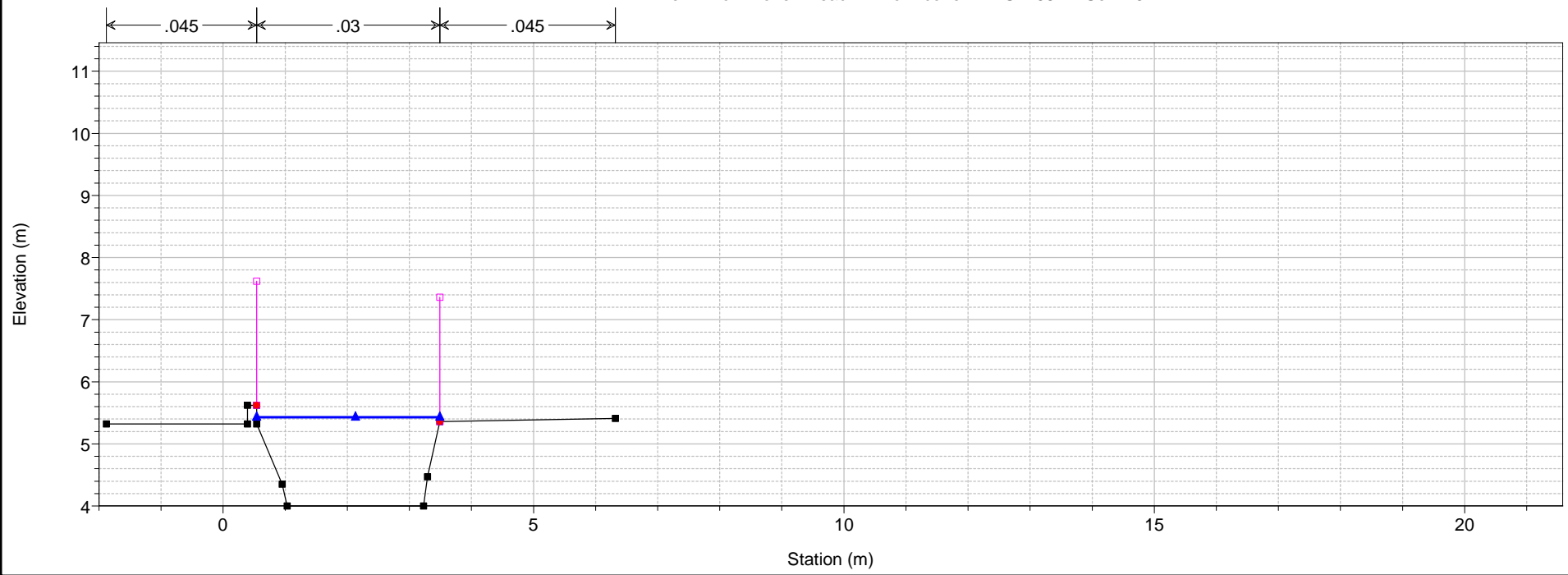

1 cm Horiz. = 1 m 1 cm Vert. = 1 m

1) A TR 200 2) A TR 30
River = mozzinone Reach = mozzicone RS = 581.5 BR

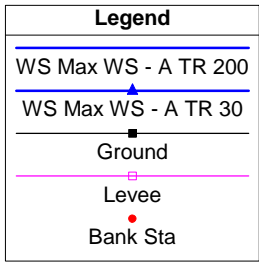
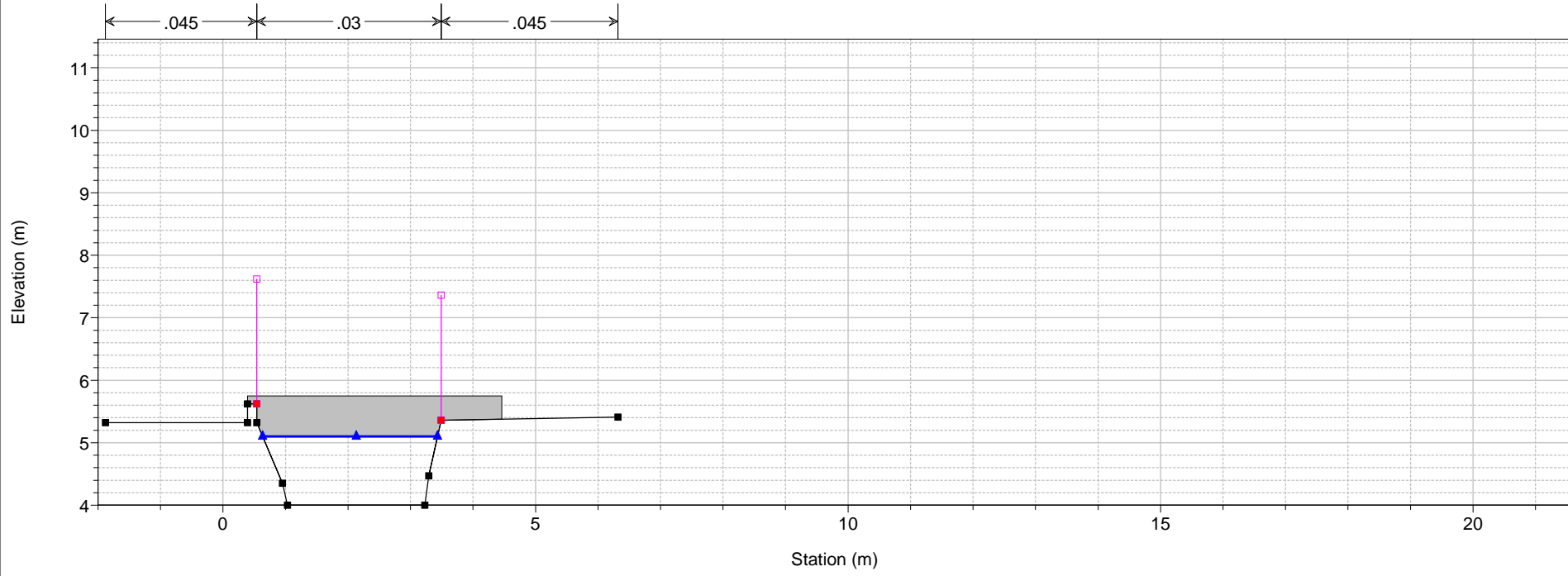

1) A TR 200 2) A TR 30
River = mozzinone Reach = mozzicone RS = 581.5 BR

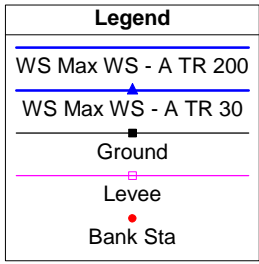
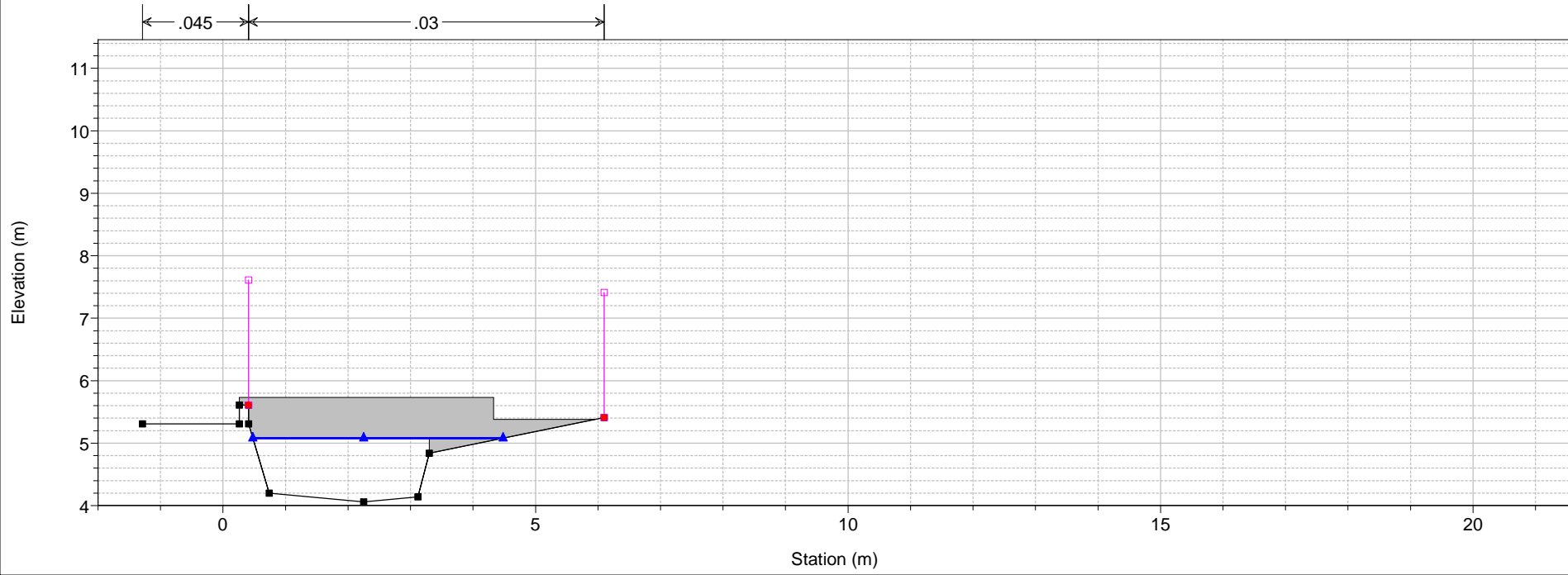

1 cm Horiz. = 1 m 1 cm Vert. = 1 m

1) A TR 200 2) A TR 30
 River = mozzicone Reach = mozzicone RS = 581 Sez. 12

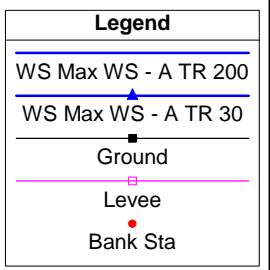
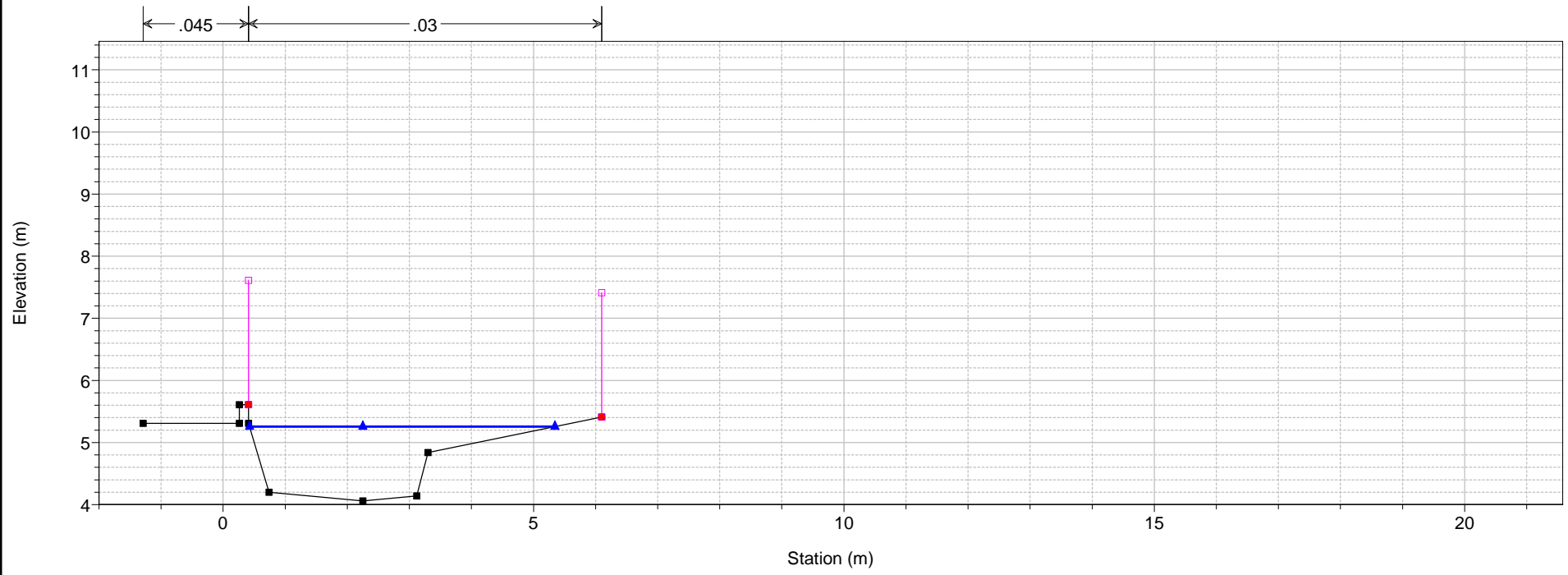

1) A TR 200 2) A TR 30
 River = mozzicone Reach = mozzicone RS = 580 Sez. 11bis

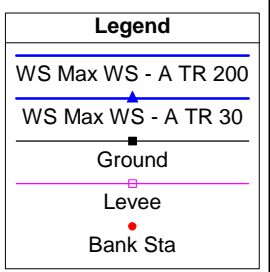
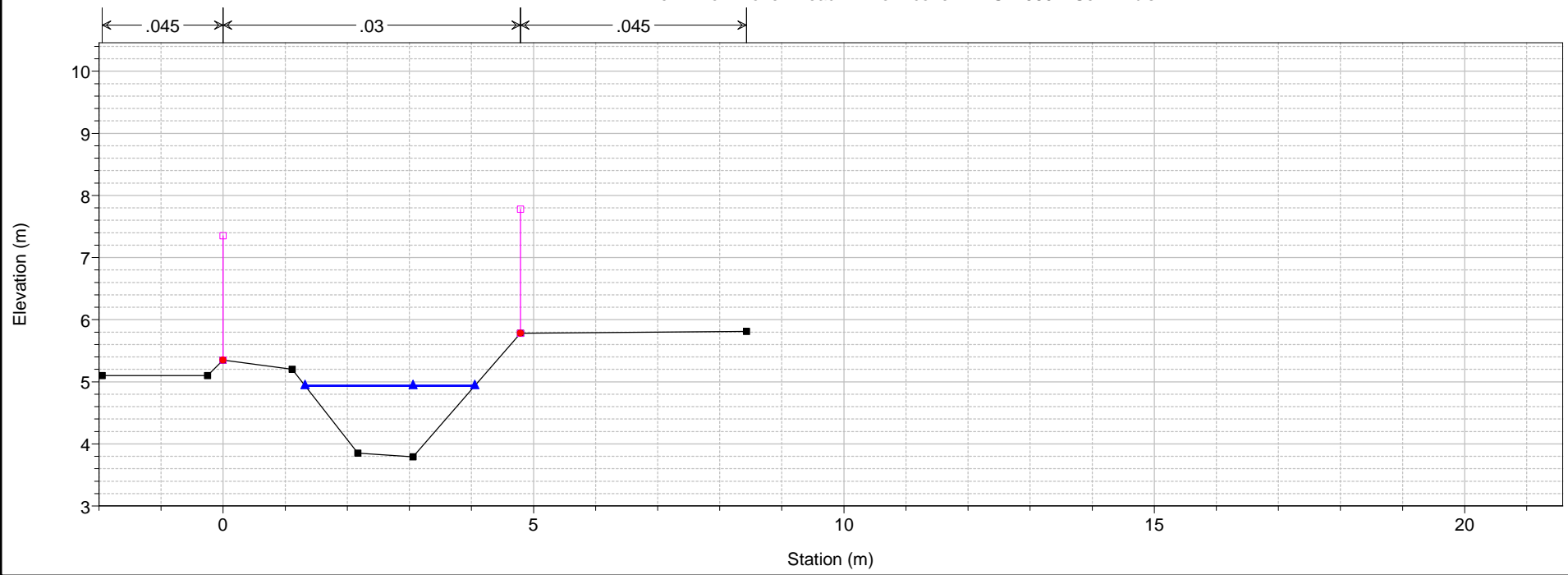

1 cm Horiz. = 1 m 1 cm Vert. = 1 m

1) A TR 200 2) A TR 30
 River = mozzicone Reach = mozzicone RS = 579 Sez. 11

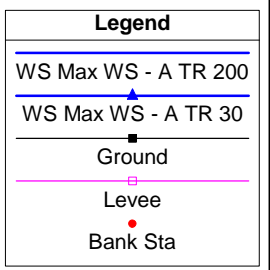
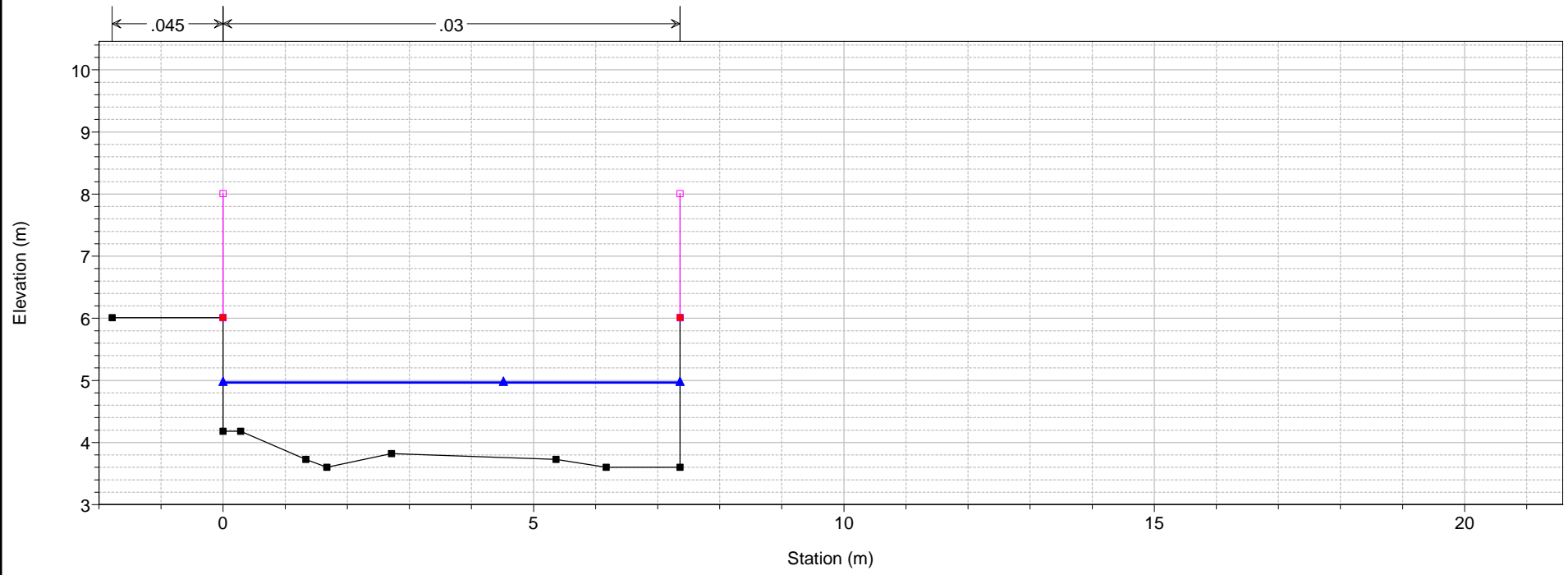

1) A TR 200 2) A TR 30
 River = mozzicone Reach = mozzicone RS = 578.5 BR

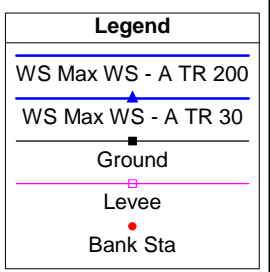
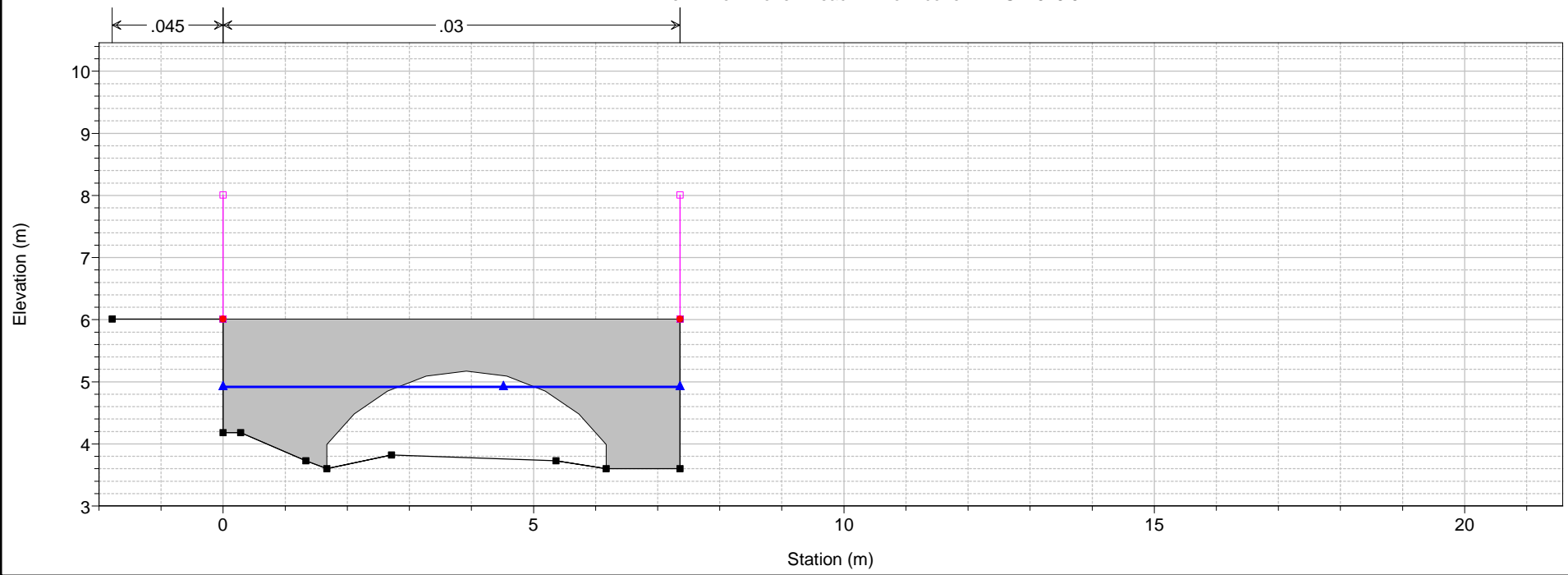

1 cm Horiz. = 1 m 1 cm Vert. = 1 m

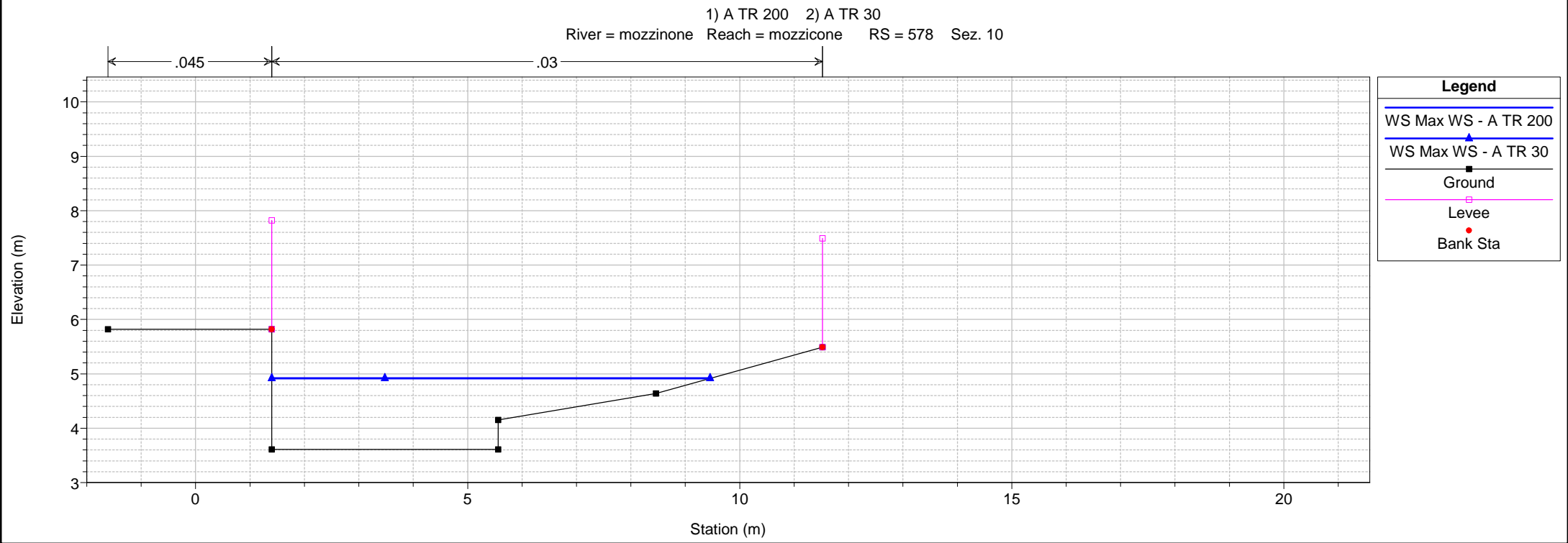
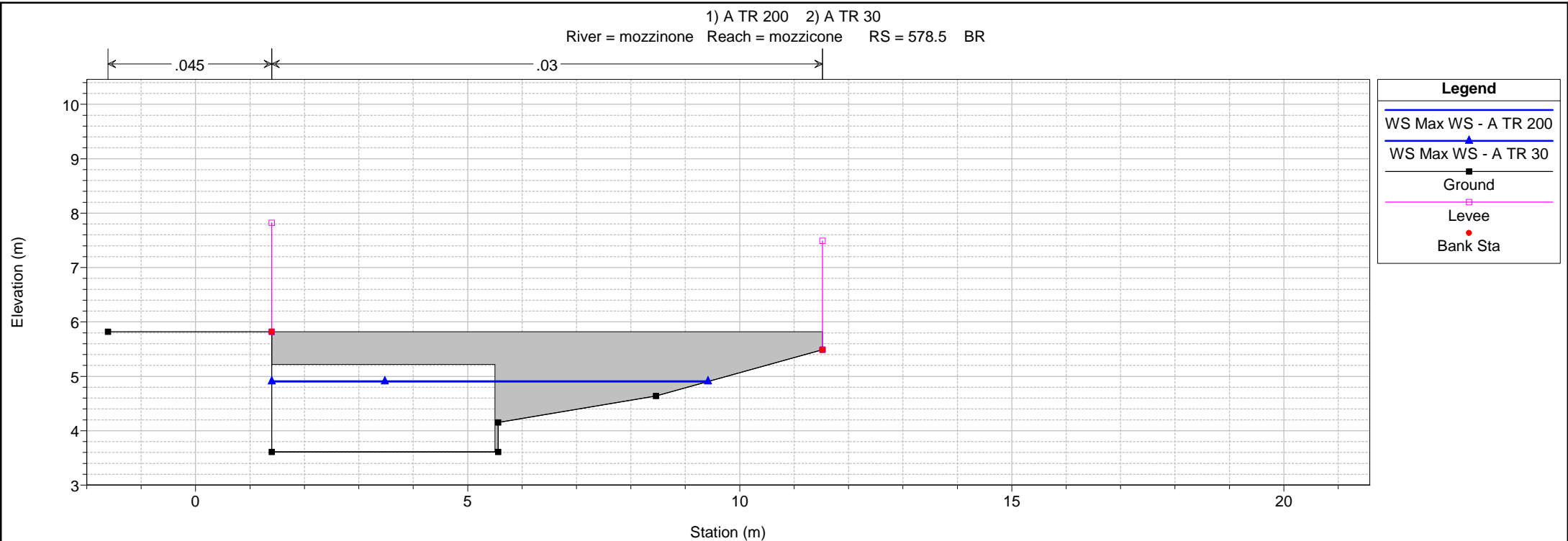

1 cm Horiz. = 1 m 1 cm Vert. = 1 m

1) A TR 200 2) A TR 30
 River = mozzinone Reach = mozzicone RS = 577 Sez. 9

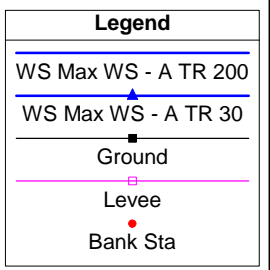
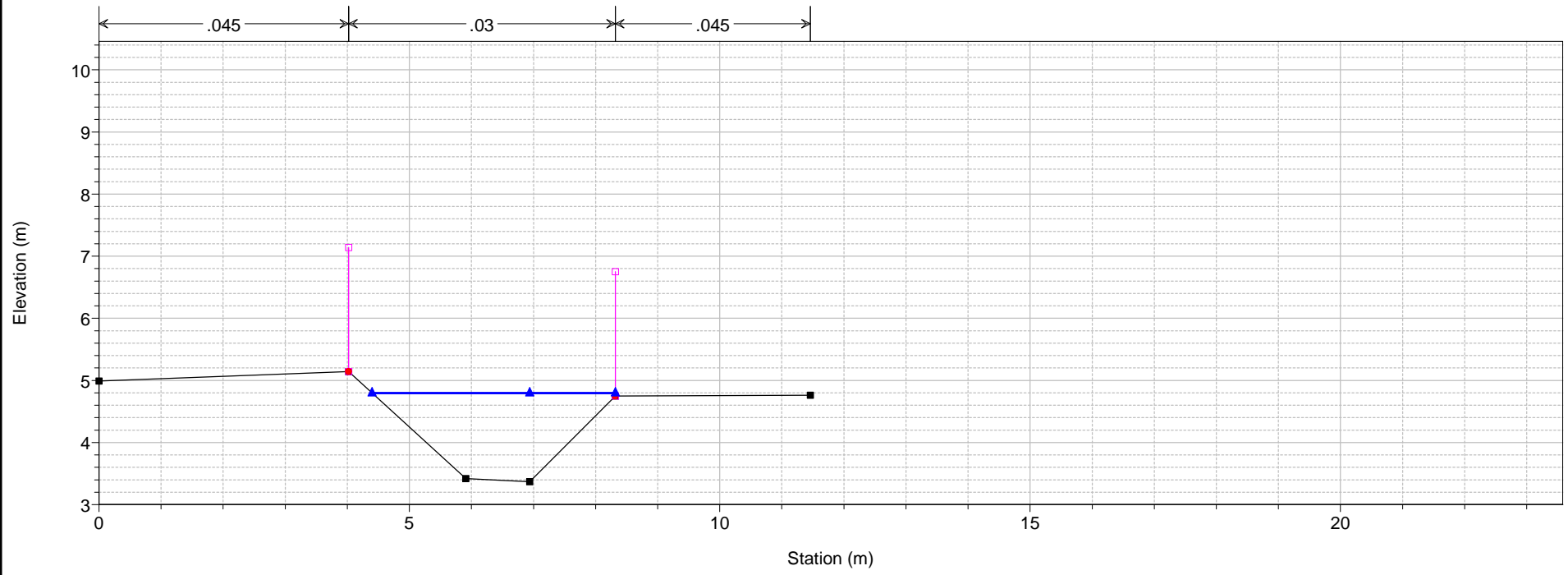

1) A TR 200 2) A TR 30
 River = mozzinone Reach = mozzicone RS = 576 Sez. 8

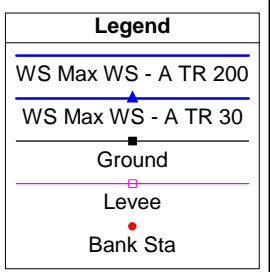
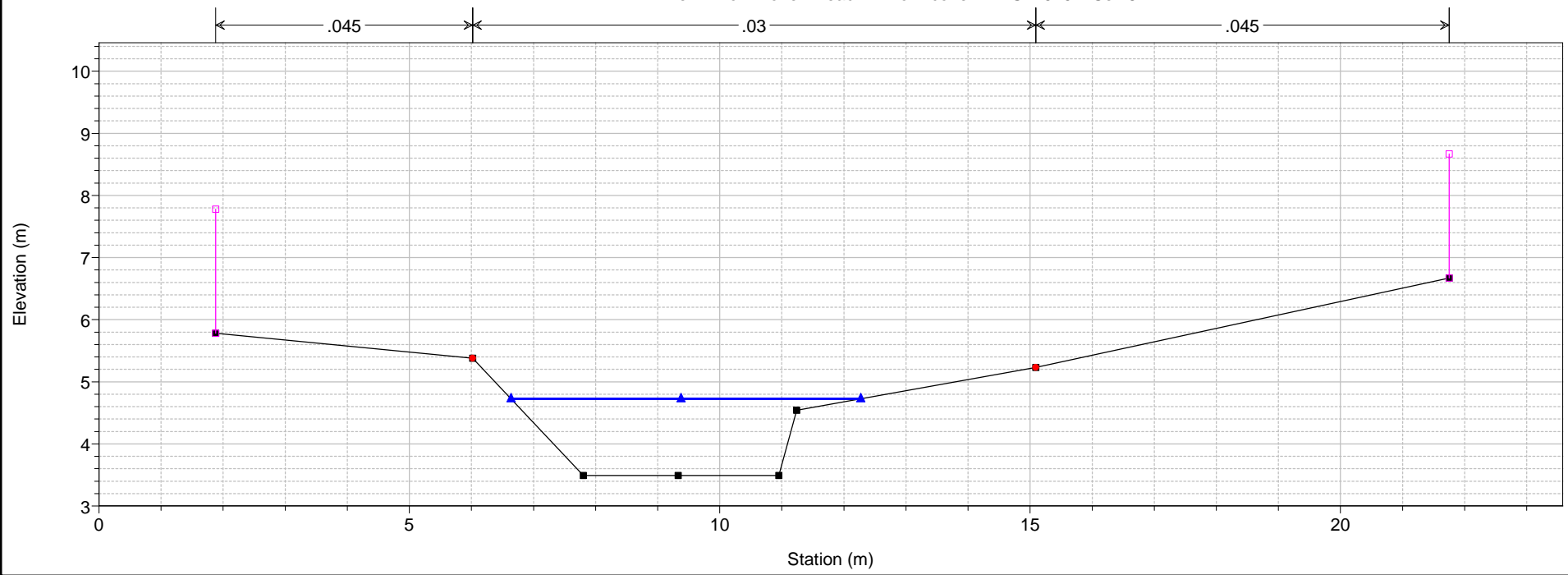

1) A TR 200 2) A TR 30
 River = mozzicone Reach = mozzicone RS = 575.5 BR

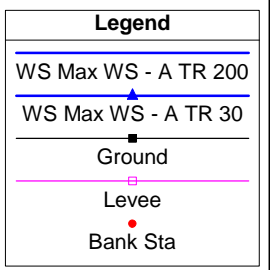
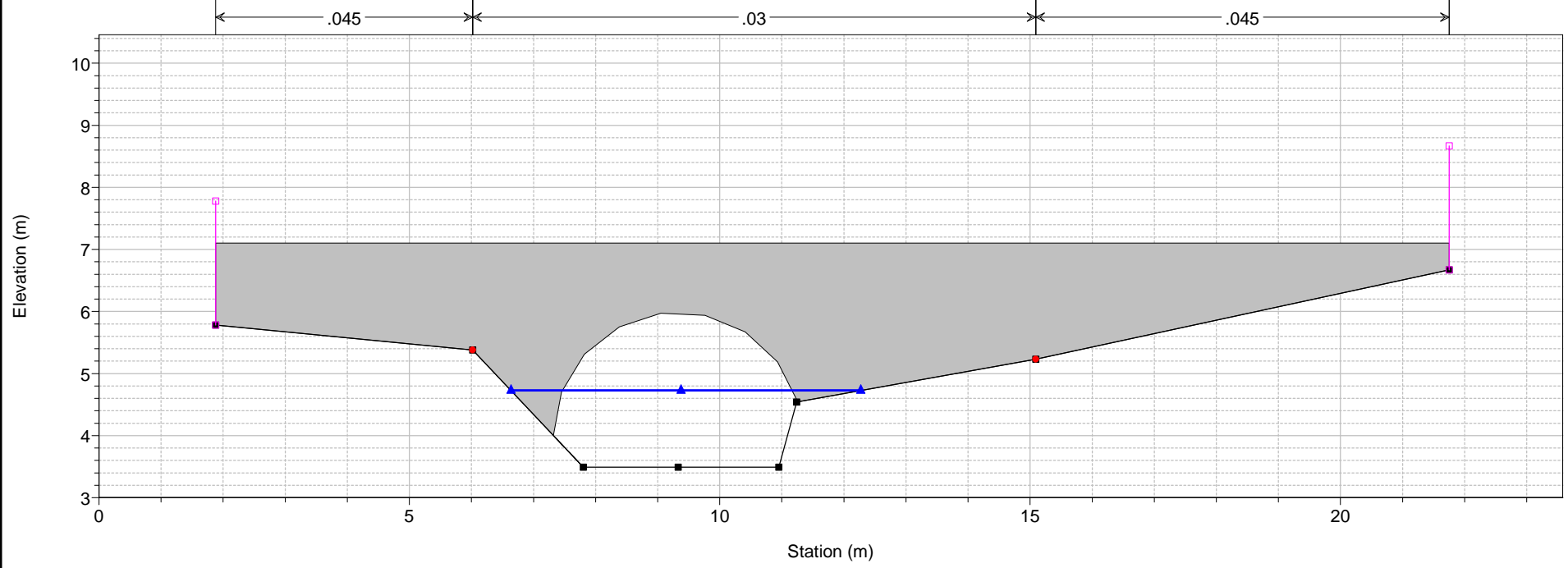

1) A TR 200 2) A TR 30
 River = mozzicone Reach = mozzicone RS = 575.5 BR

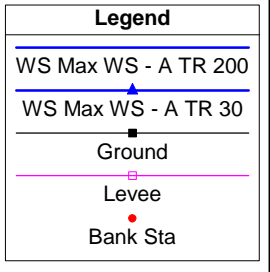
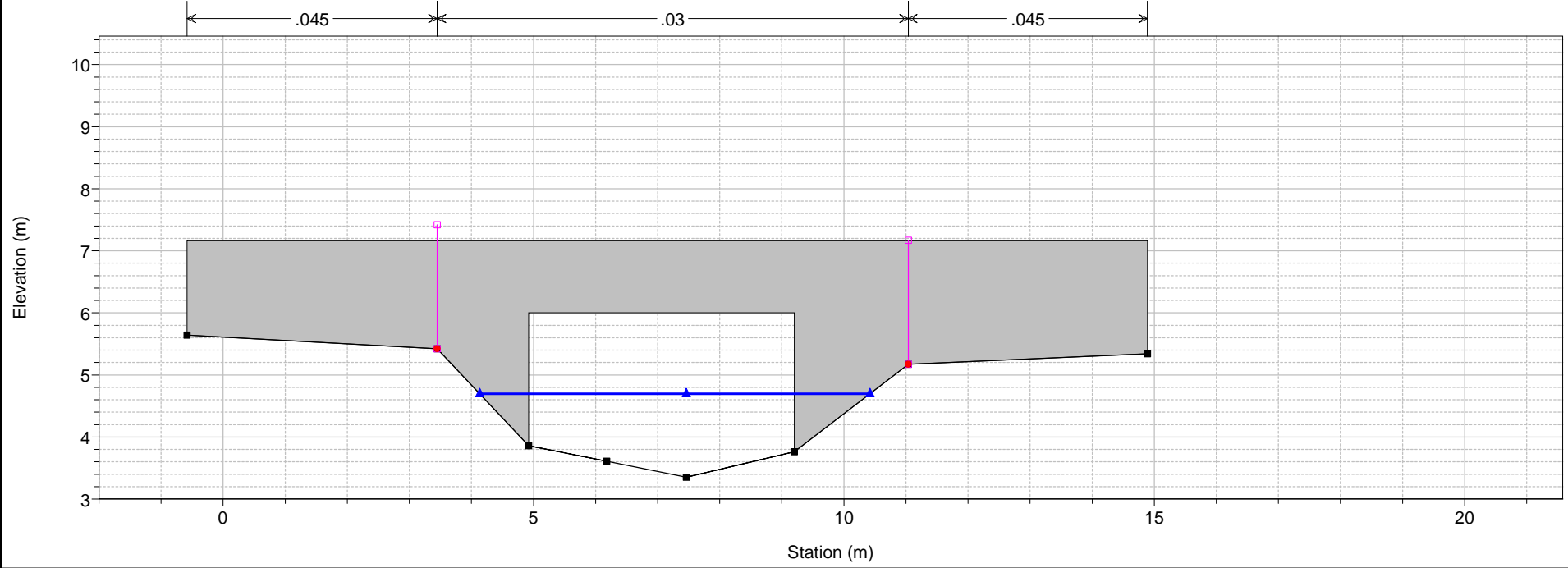

1 cm Horiz. = 1 m 1 cm Vert. = 1 m

1) A TR 200 2) A TR 30
 River = mozzinone Reach = mozzicone RS = 575 Sez. 7

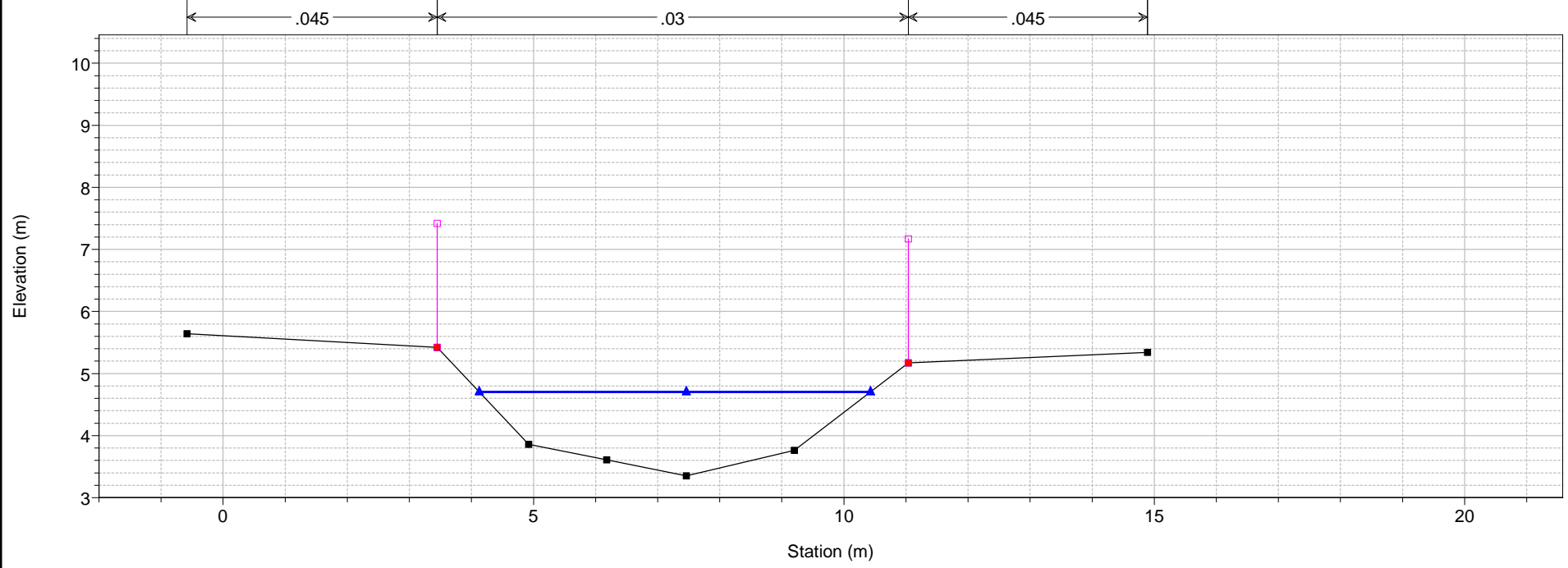

1) A TR 200 2) A TR 30
 River = mozzinone Reach = mozzicone RS = 573

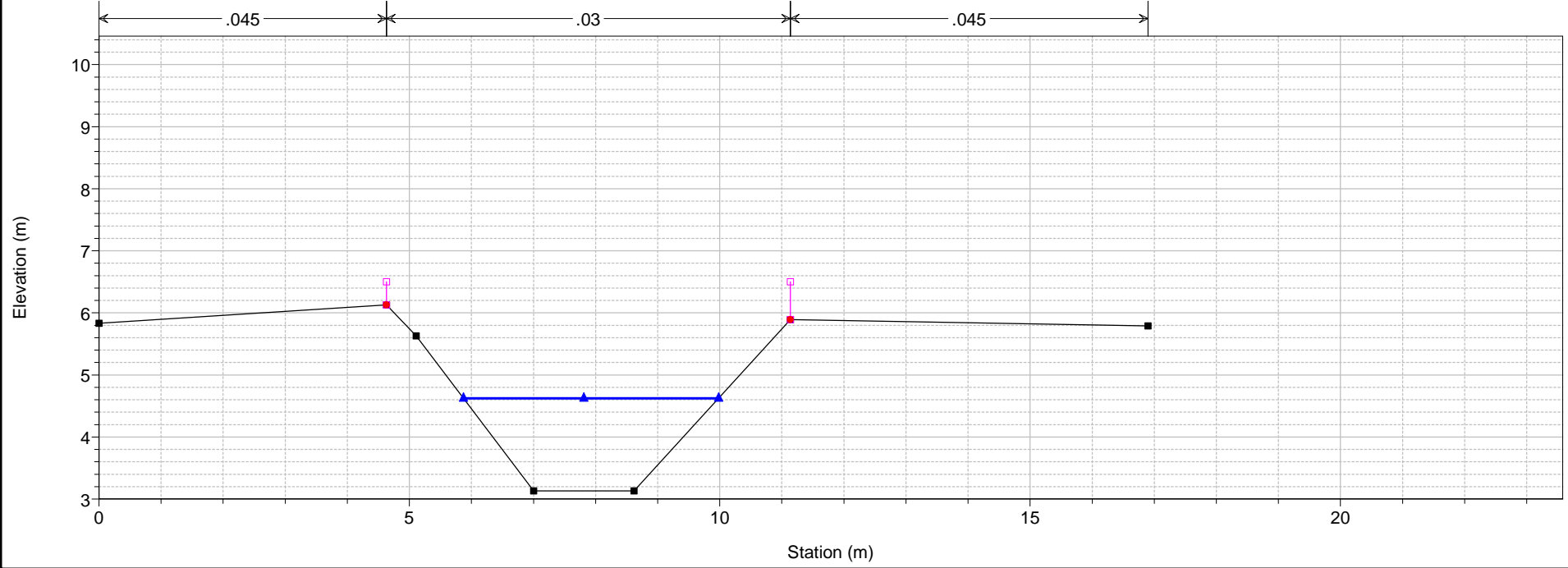

1 cm Horiz. = 1 m 1 cm Vert. = 1 m

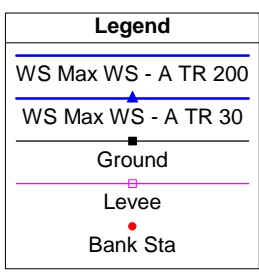
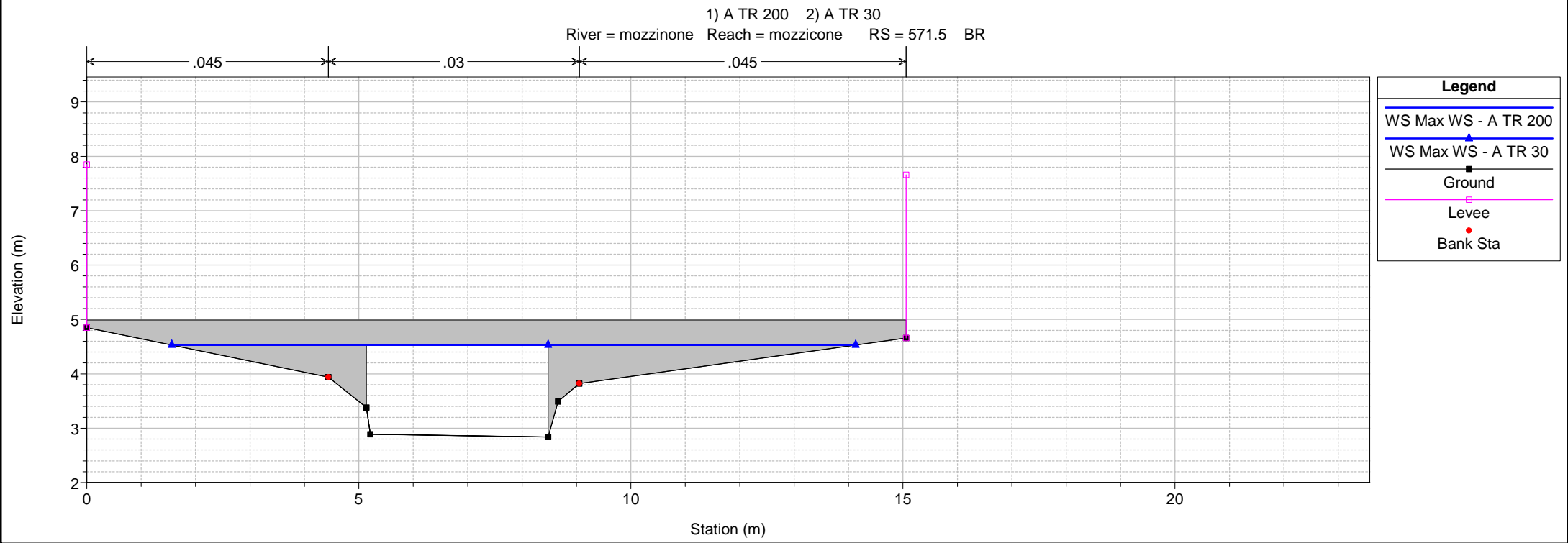
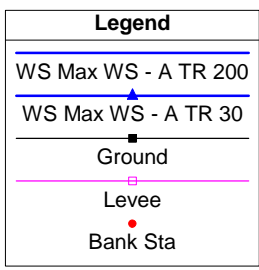
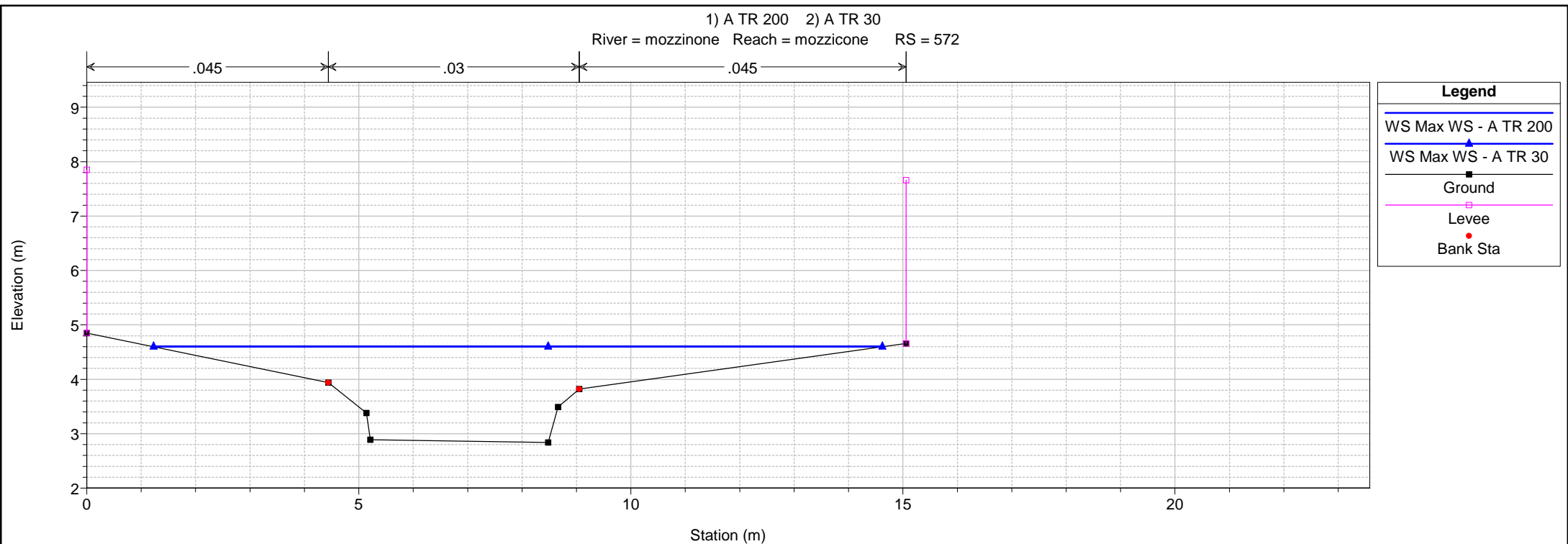

1 cm Horiz. = 1 m 1 cm Vert. = 1 m

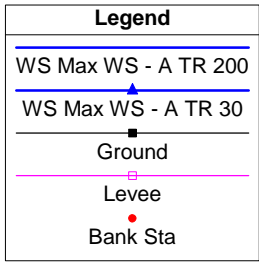
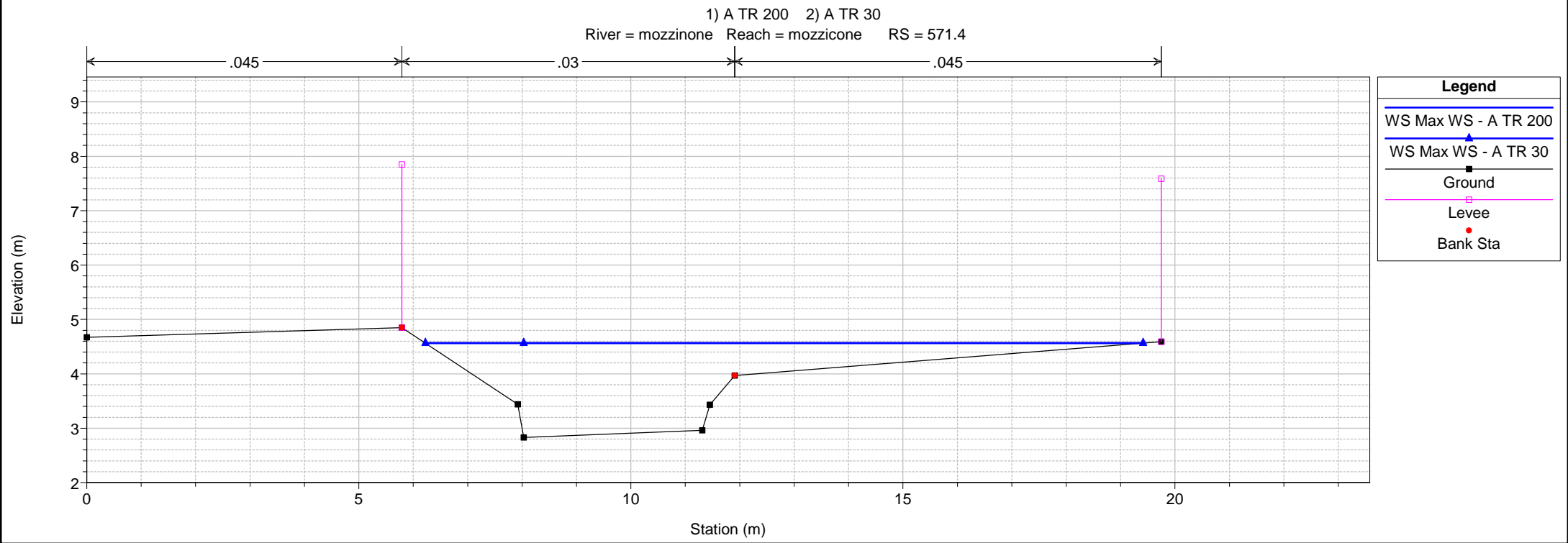
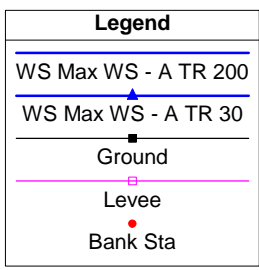
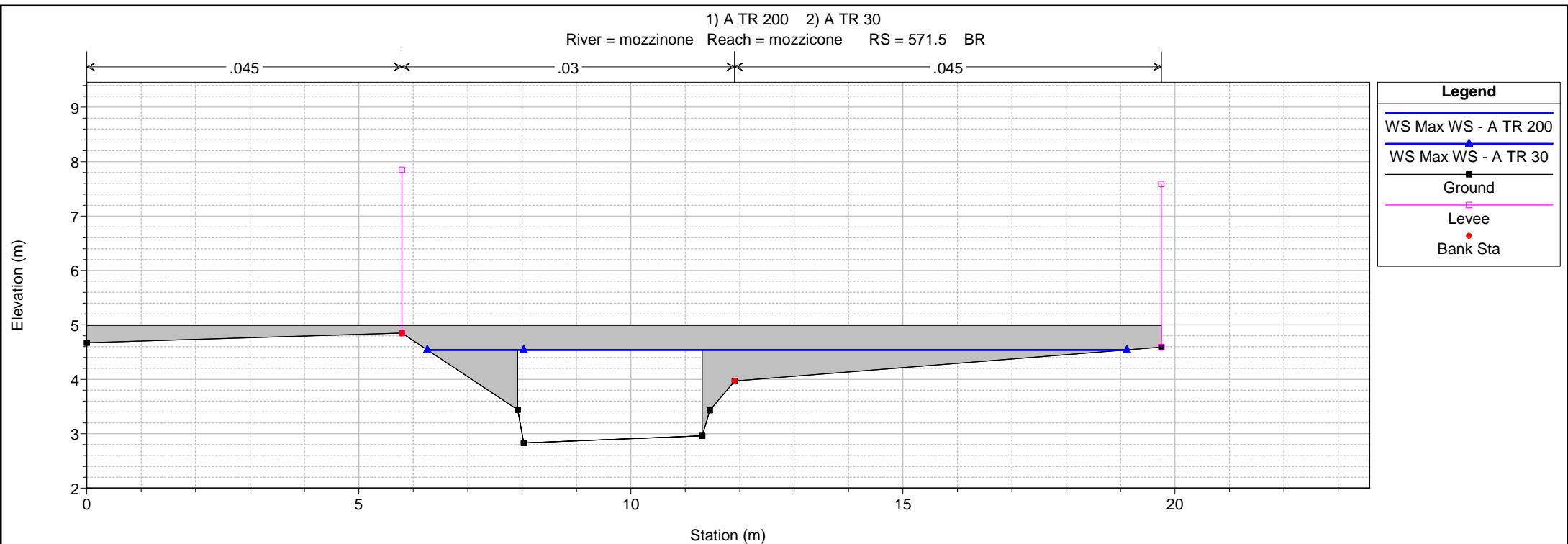

1 cm Horiz. = 1 m 1 cm Vert. = 1 m

1) A TR 200 2) A TR 30
 River = mozzicone Reach = mozzicone RS = 571

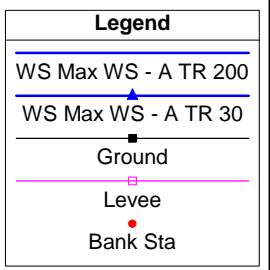
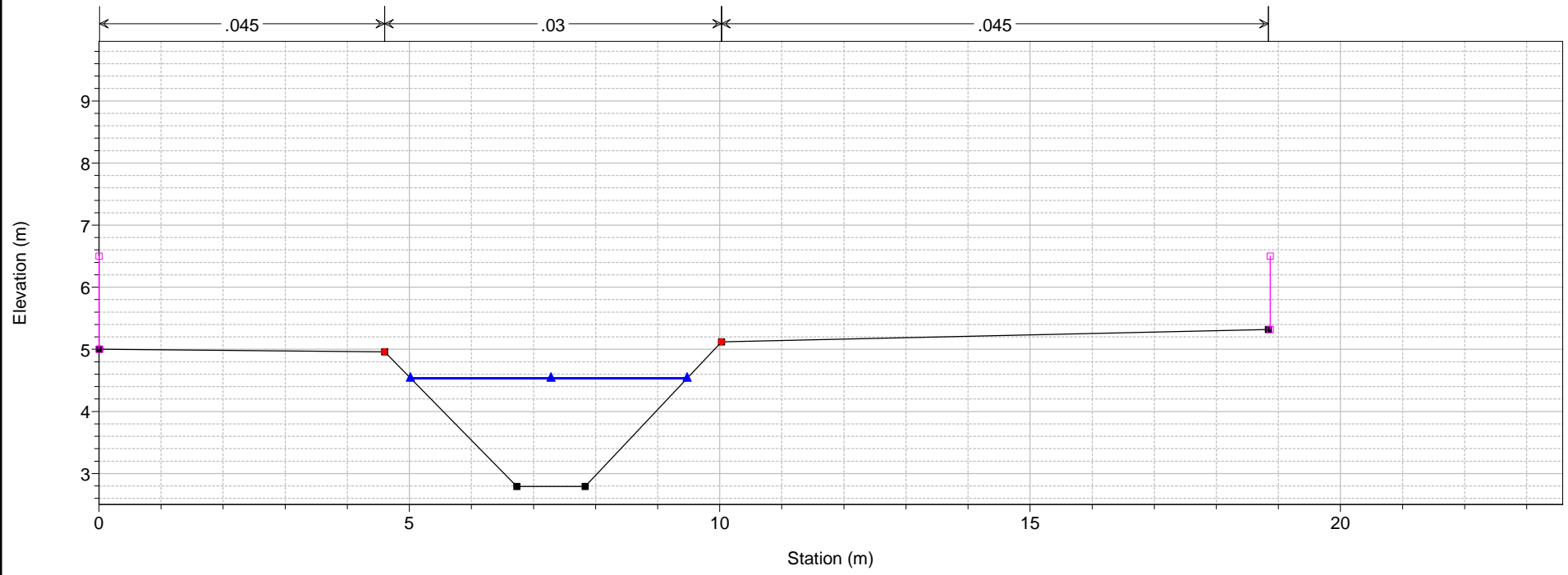

1) A TR 200 2) A TR 30
 River = mozzicone Reach = mozzicone RS = 569

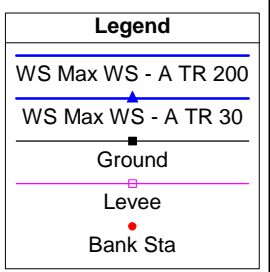
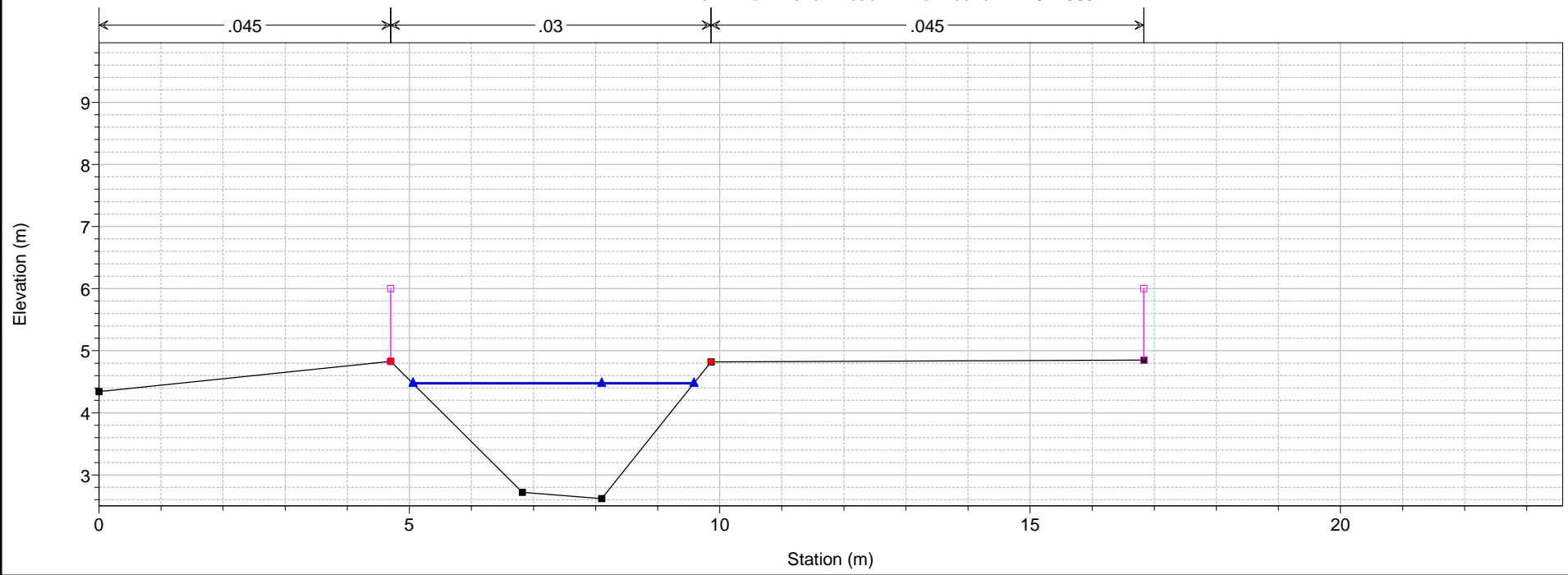

1) A TR 200 2) A TR 30
River = mozzicone Reach = mozzicone RS = 568

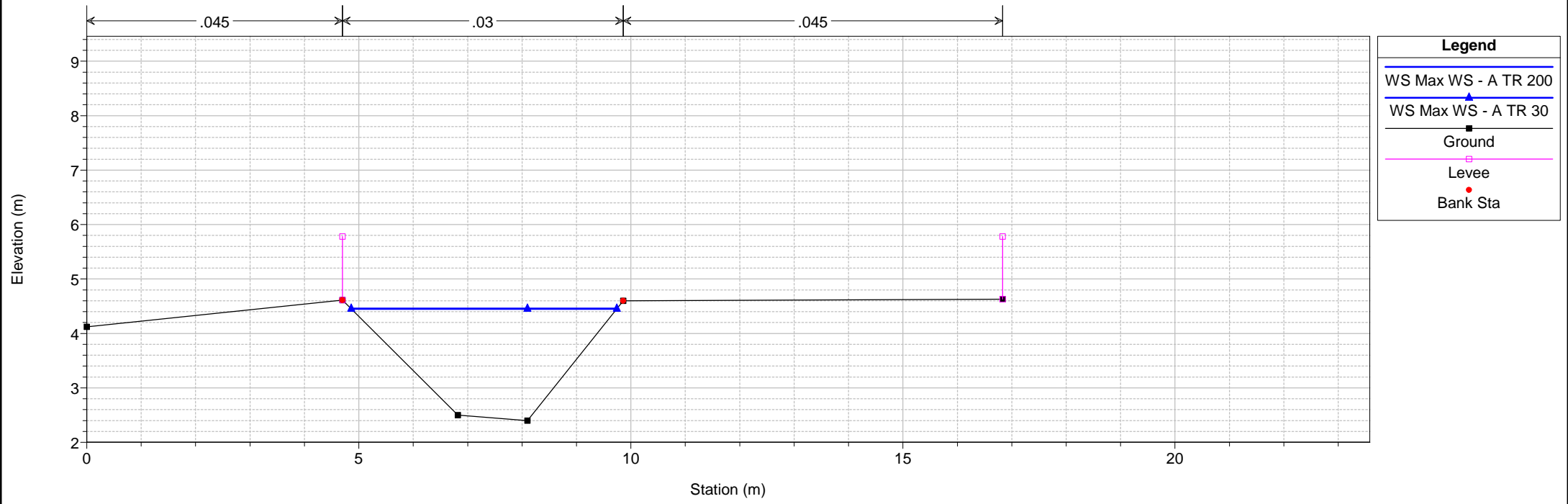

Legend

- WS Max WS - A TR 200 (Blue line with triangle)
- WS Max WS - A TR 30 (Black line with square)
- Ground (Black line with square)
- Levee (Pink line with square)
- Bank Sta (Red dot)

Reach	River Sta	Profile	Plan	Q Total (m3/s)	Min Ch El (m)	W.S. Elev (m)	Crit W.S. (m)	E.G. Elev (m)	E.G. Slope (m/m)	Vel Chnl (m/s)	Flow Area (m2)	Top Width (m)	Froude # Chl
mozzicone	583	Max WS	A TR 200	4.29	4.65	5.71	5.49	5.87	0.005940	1.78	2.41	3.24	0.66
mozzicone	583	Max WS	A TR 30	4.29	4.65	5.71	5.49	5.87	0.005952	1.78	2.41	3.24	0.66
mozzicone	582.98			Lat Struct									
mozzicone	582.97			Lat Struct									
mozzicone	582	Max WS	A TR 200	4.28	4.00	5.43	4.72	5.50	0.001952	1.17	3.66	2.95	0.34
mozzicone	582	Max WS	A TR 30	4.28	4.00	5.43	4.72	5.50	0.001958	1.17	3.66	2.95	0.34
mozzicone	581.5			Bridge									
mozzicone	581	Max WS	A TR 200	4.28	4.06	5.26	4.80	5.34	0.003123	1.24	3.44	4.93	0.47
mozzicone	581	Max WS	A TR 30	4.28	4.06	5.26	4.80	5.34	0.003131	1.25	3.44	4.92	0.48
mozzicone	580	Max WS	A TR 200	4.28	3.79	4.93	4.80	5.16	0.009299	2.12	2.02	2.74	0.79
mozzicone	580	Max WS	A TR 30	4.28	3.79	4.93	4.80	5.16	0.009341	2.12	2.02	2.73	0.79
mozzicone	579	Max WS	A TR 200	4.28	3.60	4.96	4.07	4.98	0.000236	0.48	8.86	7.36	0.14
mozzicone	579	Max WS	A TR 30	4.28	3.60	4.96	4.07	4.97	0.000237	0.48	8.84	7.36	0.14
mozzicone	578.5			Bridge									
mozzicone	578	Max WS	A TR 200	4.28	3.61	4.92	4.09	4.94	0.000516	0.60	7.10	8.06	0.21
mozzicone	578	Max WS	A TR 30	4.27	3.61	4.92	4.08	4.93	0.000517	0.60	7.08	8.06	0.21
mozzicone	577.98			Lat Struct									
mozzicone	577.97			Lat Struct									
mozzicone	577	Max WS	A TR 200	4.25	3.37	4.80	4.28	4.87	0.002174	1.21	3.50	3.92	0.41
mozzicone	577	Max WS	A TR 30	4.25	3.37	4.79	4.29	4.87	0.002184	1.22	3.49	3.92	0.41
mozzicone	576	Max WS	A TR 200	4.25	3.49	4.73	4.04	4.77	0.001068	0.86	4.93	5.66	0.29
mozzicone	576	Max WS	A TR 30	4.24	3.49	4.72	4.04	4.76	0.001073	0.86	4.91	5.63	0.30
mozzicone	575.5			Bridge									
mozzicone	575	Max WS	A TR 200	4.25	3.35	4.71	4.05	4.73	0.000662	0.74	5.72	6.31	0.25
mozzicone	575	Max WS	A TR 30	4.24	3.35	4.70	4.05	4.73	0.000666	0.74	5.70	6.30	0.25
mozzicone	573	Max WS	A TR 200	4.25	3.13	4.63	3.90	4.68	0.001230	0.99	4.29	4.12	0.31
mozzicone	573	Max WS	A TR 30	4.24	3.13	4.62	3.90	4.67	0.001236	0.99	4.28	4.11	0.31
mozzicone	572	Max WS	A TR 200	4.25	2.84	4.60	3.42	4.61	0.000194	0.53	10.33	13.44	0.14
mozzicone	572	Max WS	A TR 30	4.23	2.84	4.60	3.42	4.61	0.000195	0.53	10.28	13.39	0.14
mozzicone	571.5			Bridge									
mozzicone	571.4	Max WS	A TR 200	4.25	2.83	4.57	3.44	4.58	0.000260	0.54	9.45	13.24	0.15
mozzicone	571.4	Max WS	A TR 30	4.23	2.83	4.56	3.44	4.58	0.000262	0.54	9.40	13.19	0.15
mozzicone	571	Max WS	A TR 200	4.25	2.79	4.54	3.67	4.58	0.000900	0.87	4.86	4.46	0.27
mozzicone	571	Max WS	A TR 30	4.23	2.79	4.53	3.67	4.57	0.000902	0.87	4.84	4.46	0.27
mozzicone	569	Max WS	A TR 200	4.25	2.62	4.48	3.52	4.51	0.000729	0.81	5.25	4.53	0.24
mozzicone	569	Max WS	A TR 30	4.23	2.62	4.47	3.52	4.51	0.000730	0.81	5.23	4.53	0.24
mozzicone	568	Max WS	A TR 200	4.25	2.40	4.45	3.30	4.48	0.000473	0.69	6.17	4.89	0.20
mozzicone	568	Max WS	A TR 30	4.23	2.40	4.45	3.30	4.48	0.000474	0.69	6.16	4.88	0.20

Reach	River Sta	Profile	Plan	Q US (m3/s)	Q Leaving Total (m3/s)	Q DS (m3/s)	Q Weir (m3/s)	Q Gates (m3/s)	Wt Top Wdth (m)	Weir Max Depth (m)	Weir Avg Depth (m)	Min El Weir Flow (m)	E.G. US. (m)	W.S. US. (m)	E.G. DS (m)	W.S. DS (m)
mozzicone	596.98	Max WS	A TR 200	18.12	8.61	4.59	8.61		80.25	0.27	0.15	7.12	9.06	8.00	7.47	7.36
mozzicone	596.98	Max WS	A TR 30	10.47	3.84	4.58	3.84		80.25	0.24	0.09	7.12	8.30	7.80	7.47	7.36
mozzicone	596.97	Max WS	A TR 200	18.12	4.92	4.59	4.92		80.25	0.24	0.10	7.12	9.06	8.00	7.47	7.36
mozzicone	596.97	Max WS	A TR 30	10.47	2.05	4.58	2.05		52.85	0.24	0.06	7.12	8.30	7.80	7.47	7.36
mozzicone	594.98	Max WS	A TR 200	4.59	0.01	4.49	0.01		2.77	0.04	0.02	7.13	7.32	7.17	7.23	7.13
mozzicone	594.98	Max WS	A TR 30	4.58	0.01	4.49	0.01		2.70	0.04	0.02	7.13	7.32	7.17	7.23	7.13
mozzicone	594.97	Max WS	A TR 200	4.59	0.09	4.49	0.09		17.60	0.04	0.02	7.13	7.32	7.17	7.23	7.13
mozzicone	594.97	Max WS	A TR 30	4.58	0.08	4.49	0.08		16.90	0.04	0.02	7.13	7.32	7.17	7.23	7.13
mozzicone	592.98	Max WS	A TR 200	4.49	0.00	4.49	0.00					7.38	7.22	7.12	7.20	7.10
mozzicone	592.98	Max WS	A TR 30	4.49	0.00	4.49	0.00					7.38	7.22	7.12	7.20	7.10
mozzicone	592.97	Max WS	A TR 200	4.49	0.00	4.49	0.00					7.25	7.22	7.12	7.20	7.10
mozzicone	592.97	Max WS	A TR 30	4.49	0.00	4.49	0.00					7.25	7.22	7.12	7.20	7.10
mozzicone	590.98	Max WS	A TR 200	4.49	0.00	4.49	0.00					7.65	7.19	7.10	7.18	7.09
mozzicone	590.98	Max WS	A TR 30	4.49	0.00	4.49	0.00					7.65	7.19	7.10	7.18	7.09
mozzicone	590.97	Max WS	A TR 200	4.49	0.00	4.49	0.00					7.65	7.19	7.10	7.18	7.09
mozzicone	590.97	Max WS	A TR 30	4.49	0.00	4.49	0.00					7.65	7.19	7.10	7.18	7.09
mozzicone	588.98	Max WS	A TR 200	4.49	0.00	4.49	0.00					7.52	6.94	6.74	6.89	6.78
mozzicone	588.98	Max WS	A TR 30	4.49	0.00	4.49	0.00					7.52	6.94	6.74	6.88	6.78
mozzicone	588.97	Max WS	A TR 200	4.49	0.00	4.49	0.00					7.48	6.94	6.74	6.89	6.78
mozzicone	588.97	Max WS	A TR 30	4.49	0.00	4.49	0.00					7.48	6.94	6.74	6.88	6.78
mozzicone	584.98	Max WS	A TR 200	4.49	0.03	4.29	0.03		4.16	0.05	0.02	6.04	6.52	6.33	6.16	6.09
mozzicone	584.98	Max WS	A TR 30	4.49	0.03	4.29	0.03		4.08	0.05	0.02	6.04	6.52	6.33	6.16	6.09
mozzicone	584.97	Max WS	A TR 200	4.49	0.17	4.29	0.17		9.93	0.09	0.04	6.00	6.52	6.33	6.16	6.09
mozzicone	584.97	Max WS	A TR 30	4.49	0.17	4.29	0.17		9.85	0.09	0.04	6.00	6.52	6.33	6.16	6.09
mozzicone	582.98	Max WS	A TR 200	4.29	0.01	4.28	0.01		4.22	0.02	0.01	5.41	5.87	5.71	5.50	5.43
mozzicone	582.98	Max WS	A TR 30	4.29	0.01	4.28	0.01		3.83	0.02	0.01	5.41	5.87	5.71	5.50	5.43
mozzicone	582.97	Max WS	A TR 200	4.29	0.00	4.28	0.00					5.62	5.87	5.71	5.50	5.43
mozzicone	582.97	Max WS	A TR 30	4.29	0.00	4.28	0.00					5.62	5.87	5.71	5.50	5.43
mozzicone	577.98	Max WS	A TR 200	4.28	0.04	4.25	0.04		7.69	0.04	0.02	4.76	4.94	4.92	4.77	4.73
mozzicone	577.98	Max WS	A TR 30	4.27	0.03	4.24	0.03		7.18	0.03	0.02	4.76	4.93	4.92	4.76	4.72
mozzicone	577.97	Max WS	A TR 200	4.28	0.00	4.25	0.00					5.14	4.94	4.92	4.77	4.73
mozzicone	577.97	Max WS	A TR 30	4.27	0.00	4.24	0.00					5.14	4.93	4.92	4.76	4.72

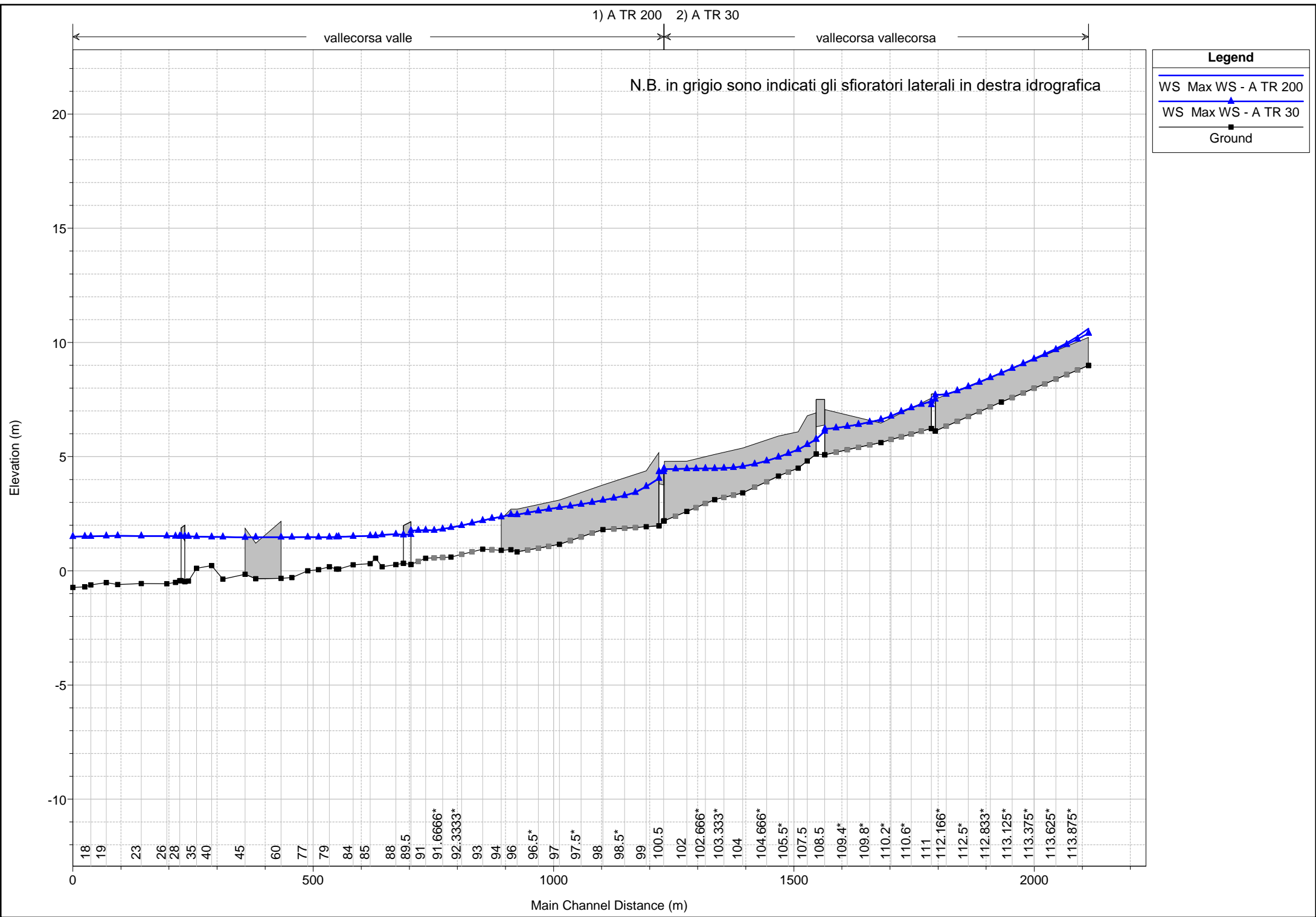

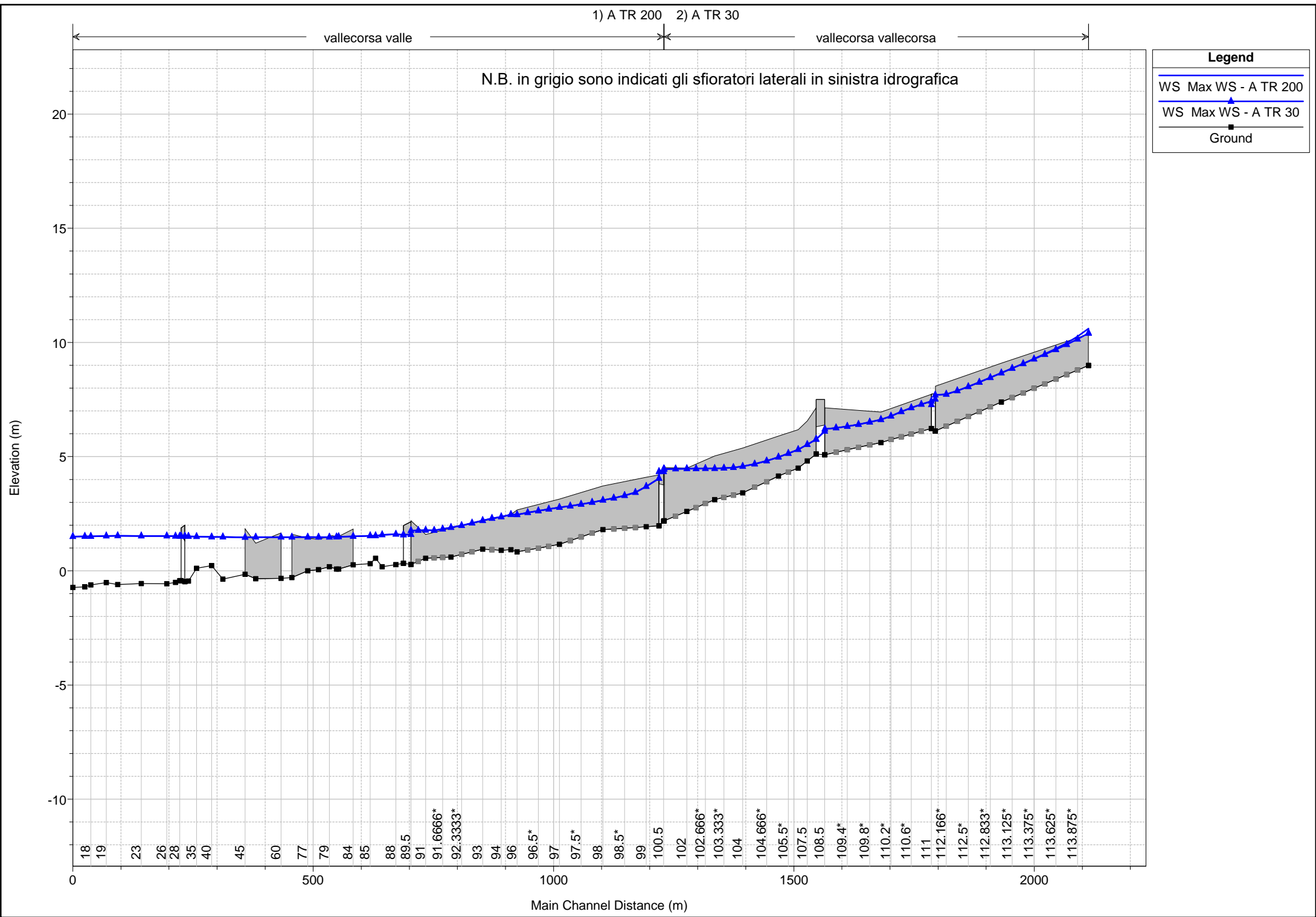

1) A TR 200 2) A TR 30
River = vallecorsa Reach = vallecorsa RS = 114 Sez. 7v

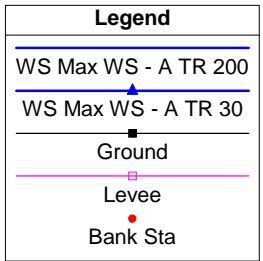
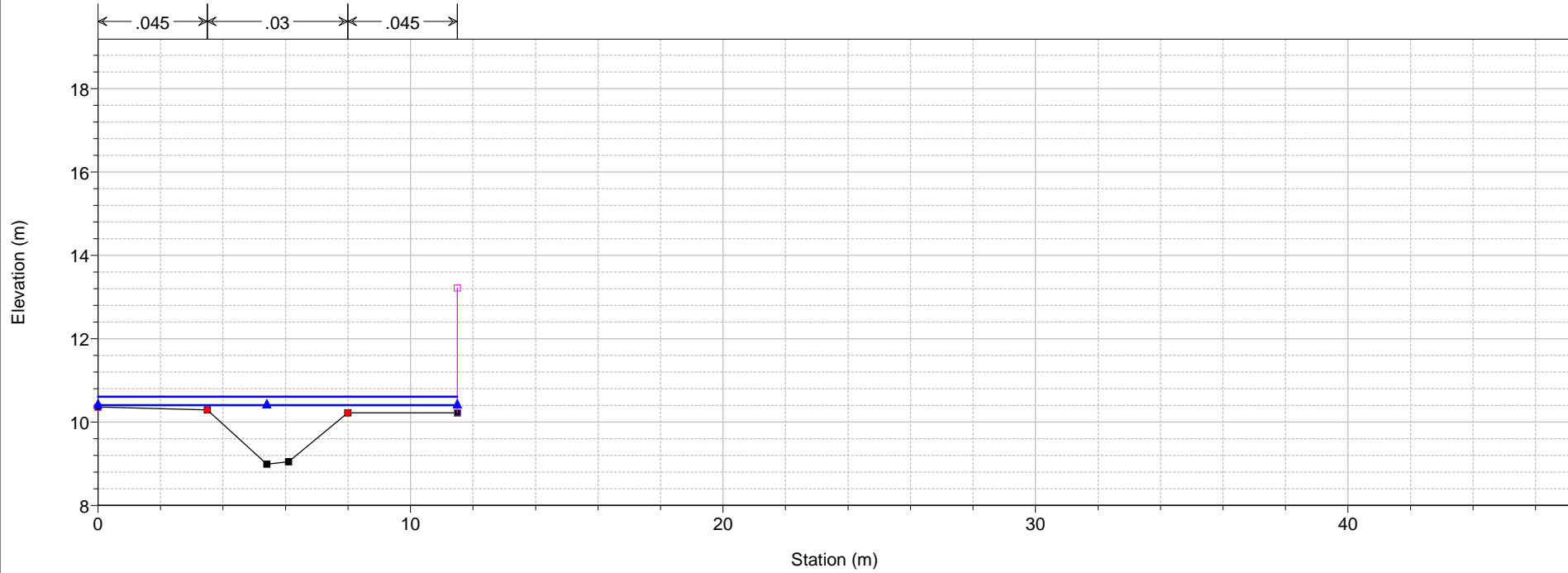

1) A TR 200 2) A TR 30
River = vallecorsa Reach = vallecorsa RS = 113.99 Sez. 7v

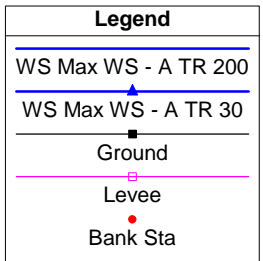
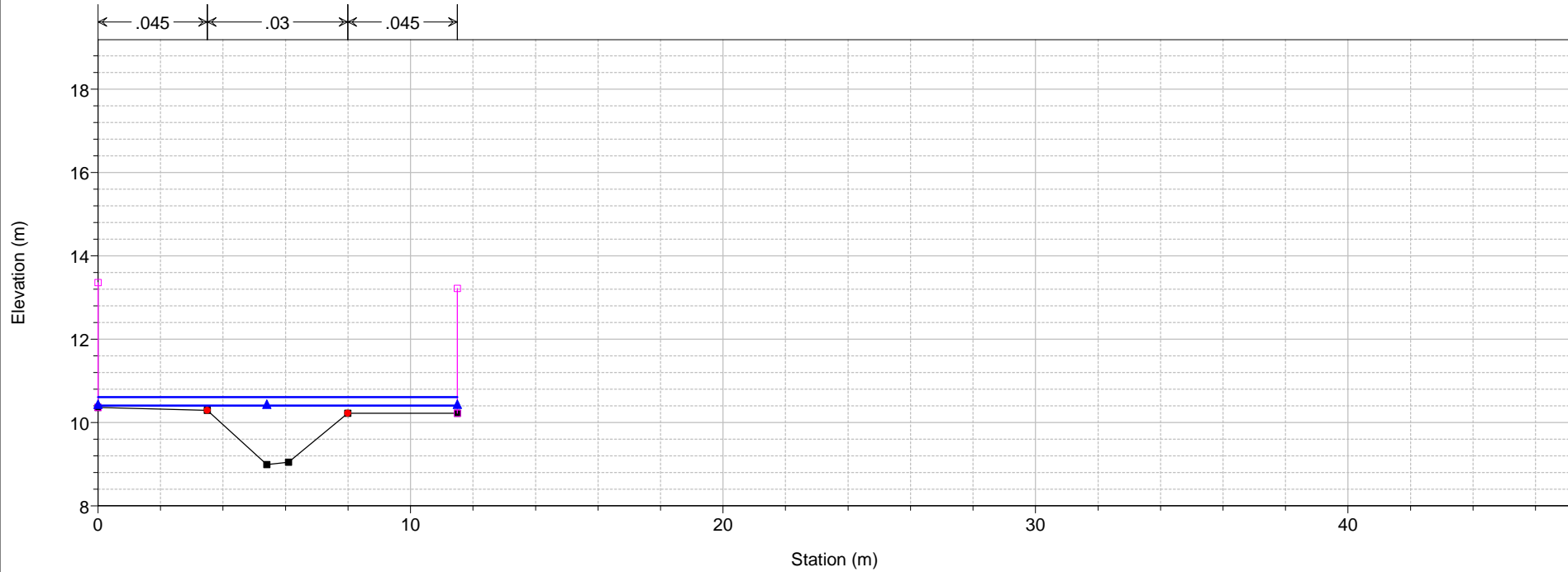

1) A TR 200 2) A TR 30
 River = vallecorsa Reach = vallecorsa RS = 113 Sez. 6v

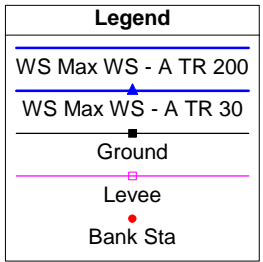
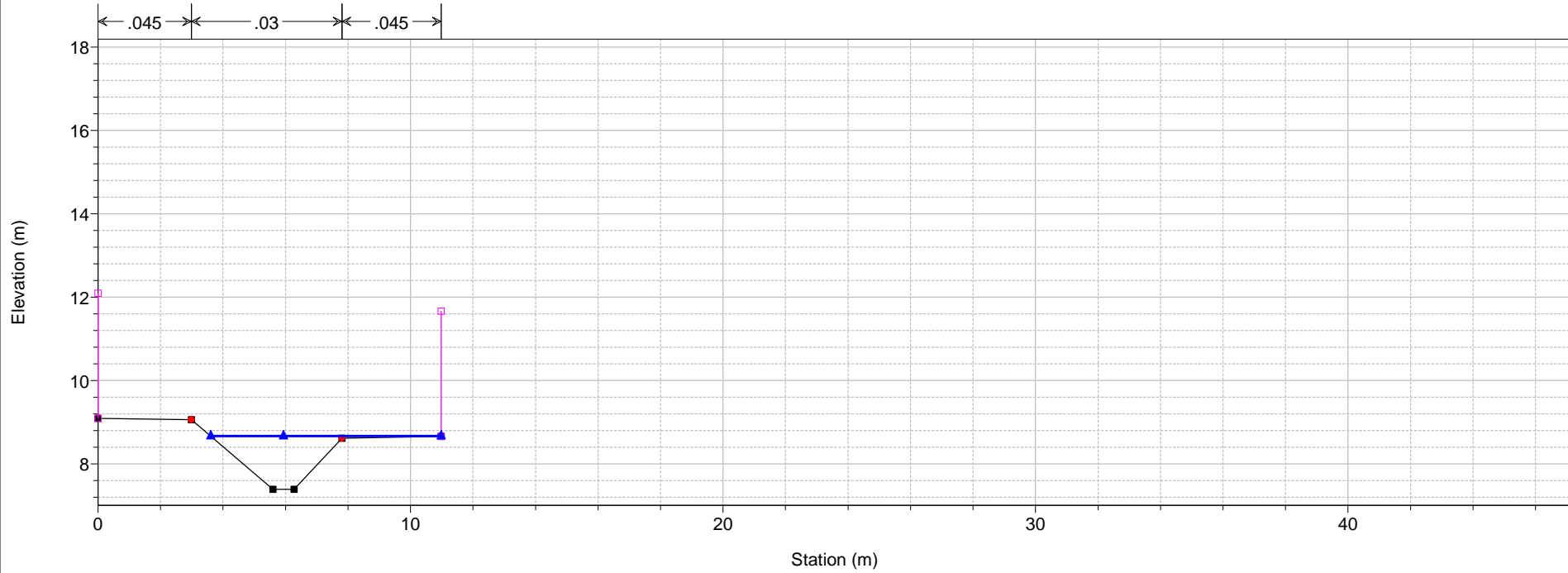

1) A TR 200 2) A TR 30
 River = vallecorsa Reach = vallecorsa RS = 112 Sez. 5v

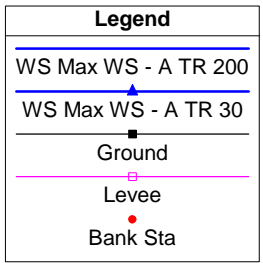
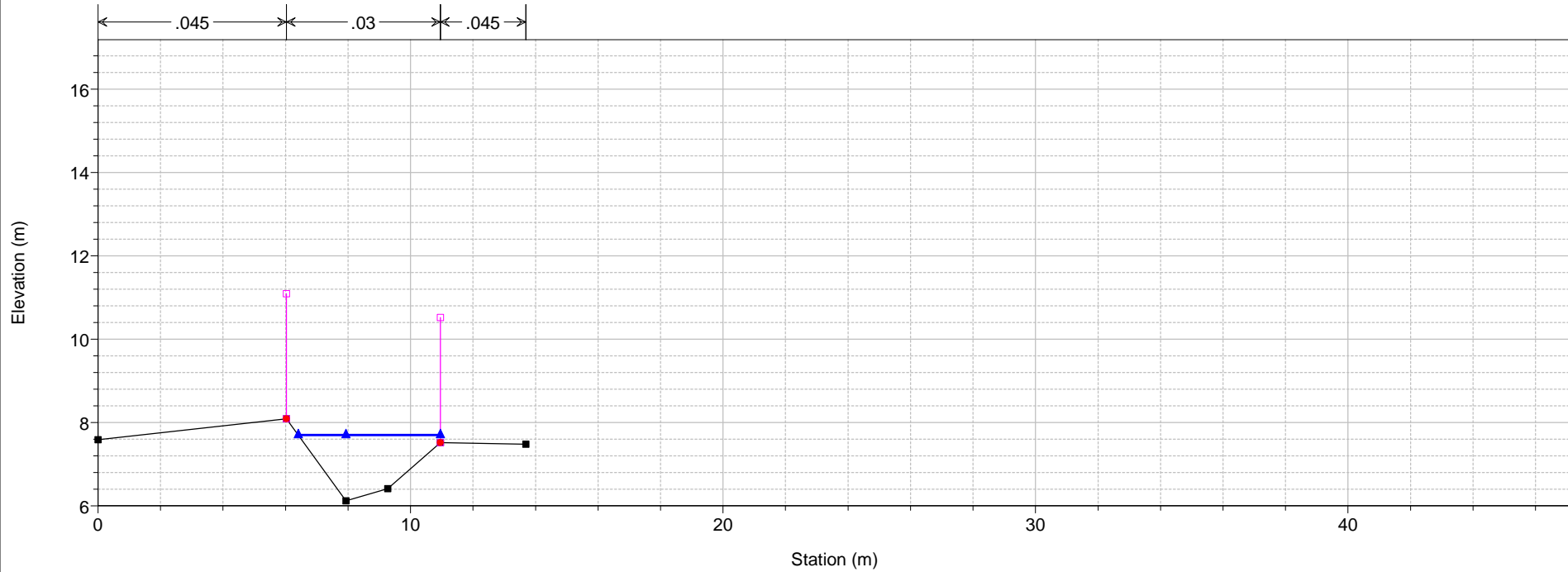

1) A TR 200 2) A TR 30
River = vallecorsa Reach = vallecorsa RS = 111.5 BR

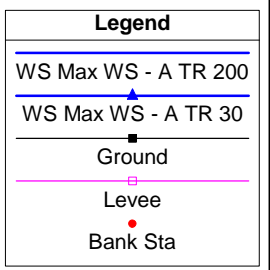
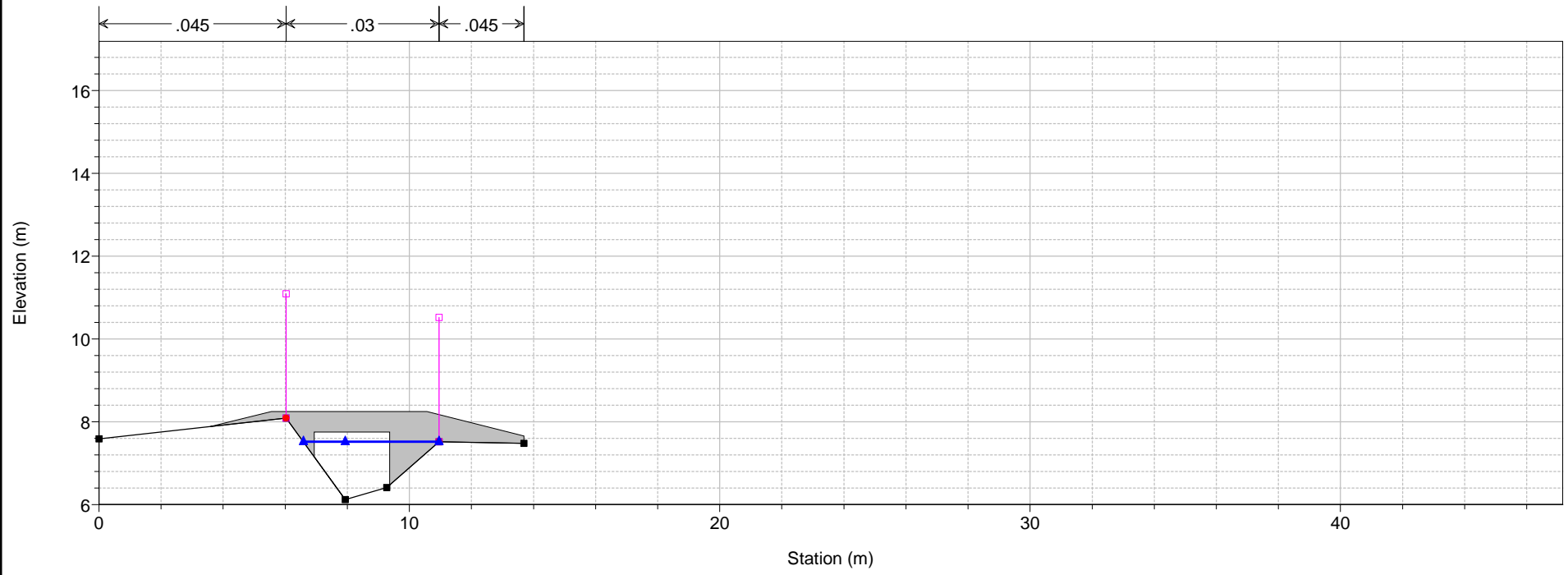

1) A TR 200 2) A TR 30
River = vallecorsa Reach = vallecorsa RS = 111.5 BR

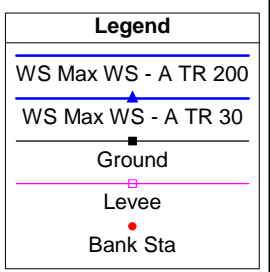
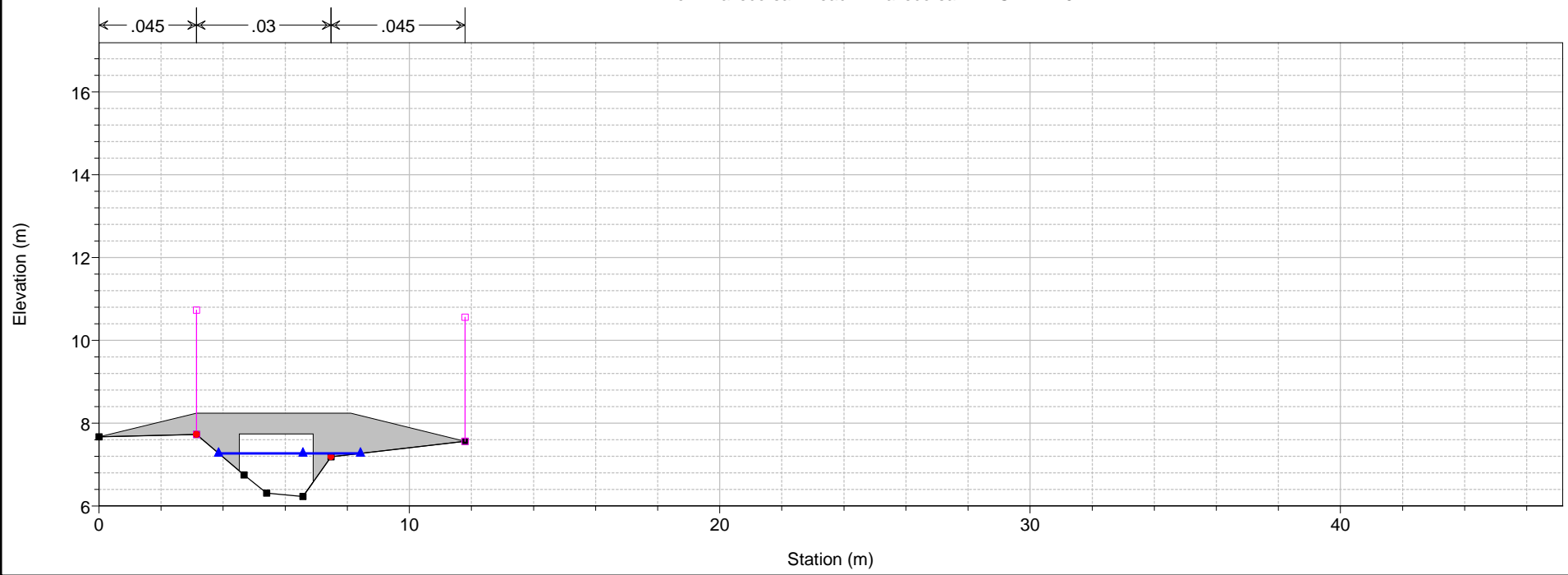

1 cm Horiz. = 2 m 1 cm Vert. = 1.5 m

1) A TR 200 2) A TR 30
River = vallecorsa Reach = vallecorsa RS = 111 Sez. 4v

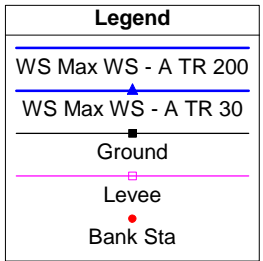
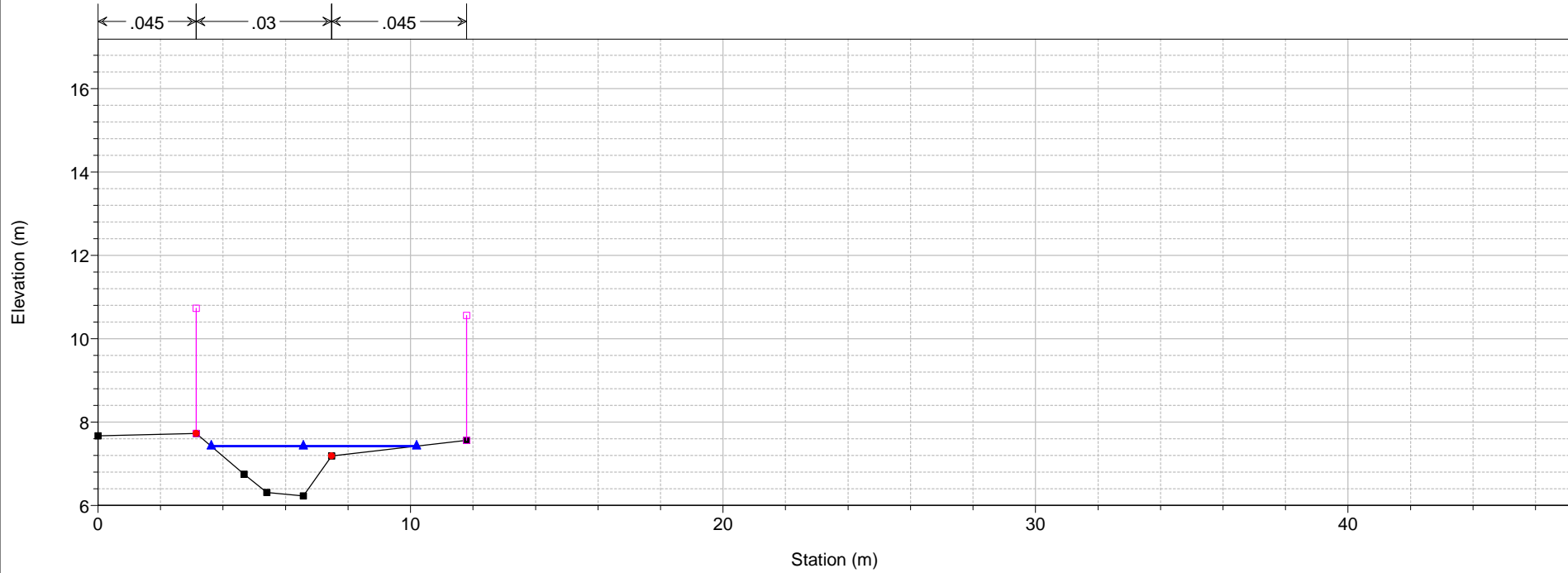

1) A TR 200 2) A TR 30
River = vallecorsa Reach = vallecorsa RS = 110 Sez. 3v

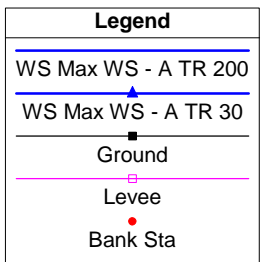
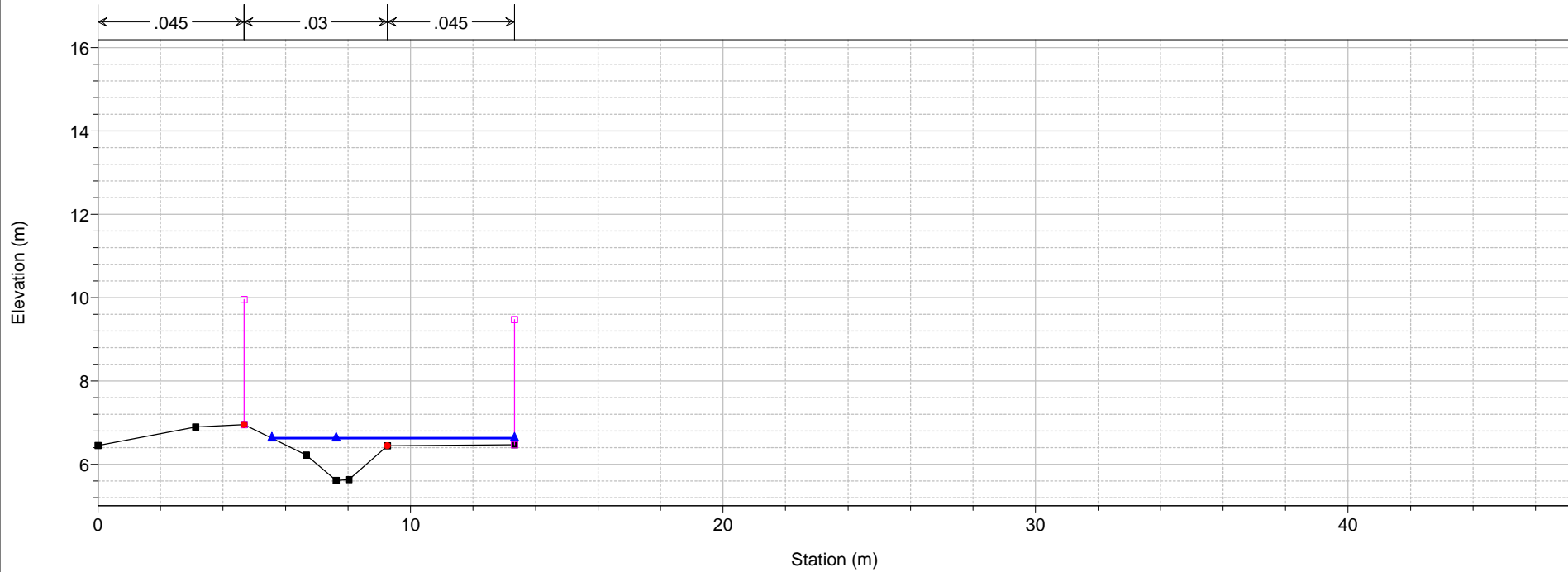

1) A TR 200 2) A TR 30
 River = vallecorsa Reach = vallecorsa RS = 109 Sez. 2v

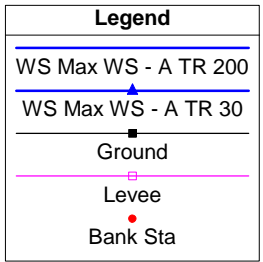
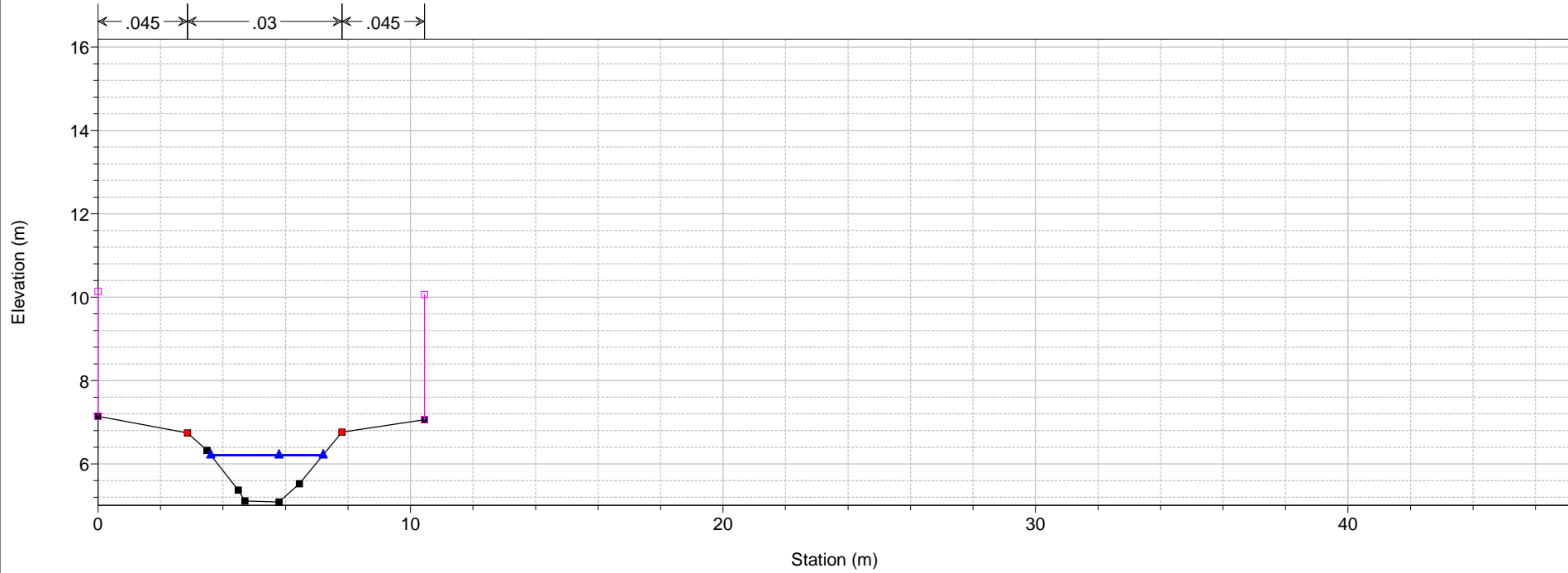

1) A TR 200 2) A TR 30
 River = vallecorsa Reach = vallecorsa RS = 108.5 BR

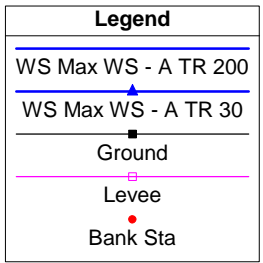
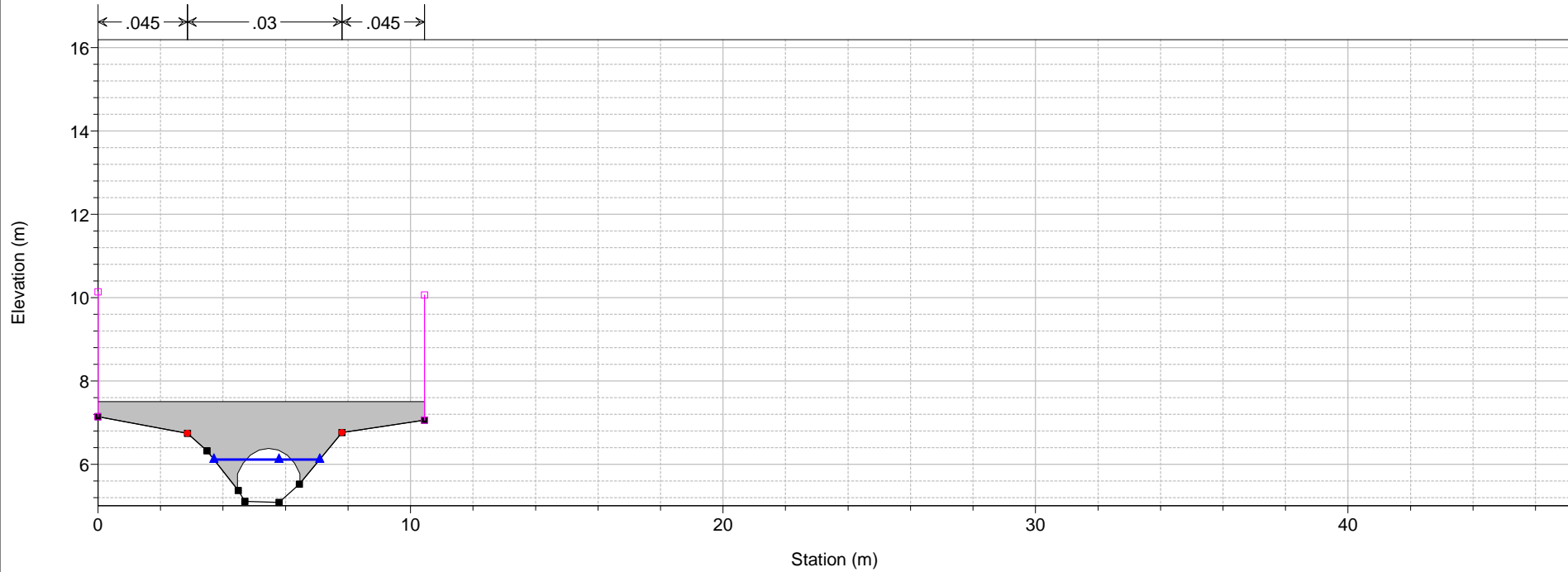

1) A TR 200 2) A TR 30
 River = vallecorsa Reach = vallecorsa RS = 108.5 BR

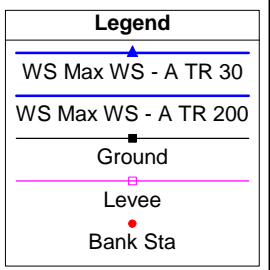
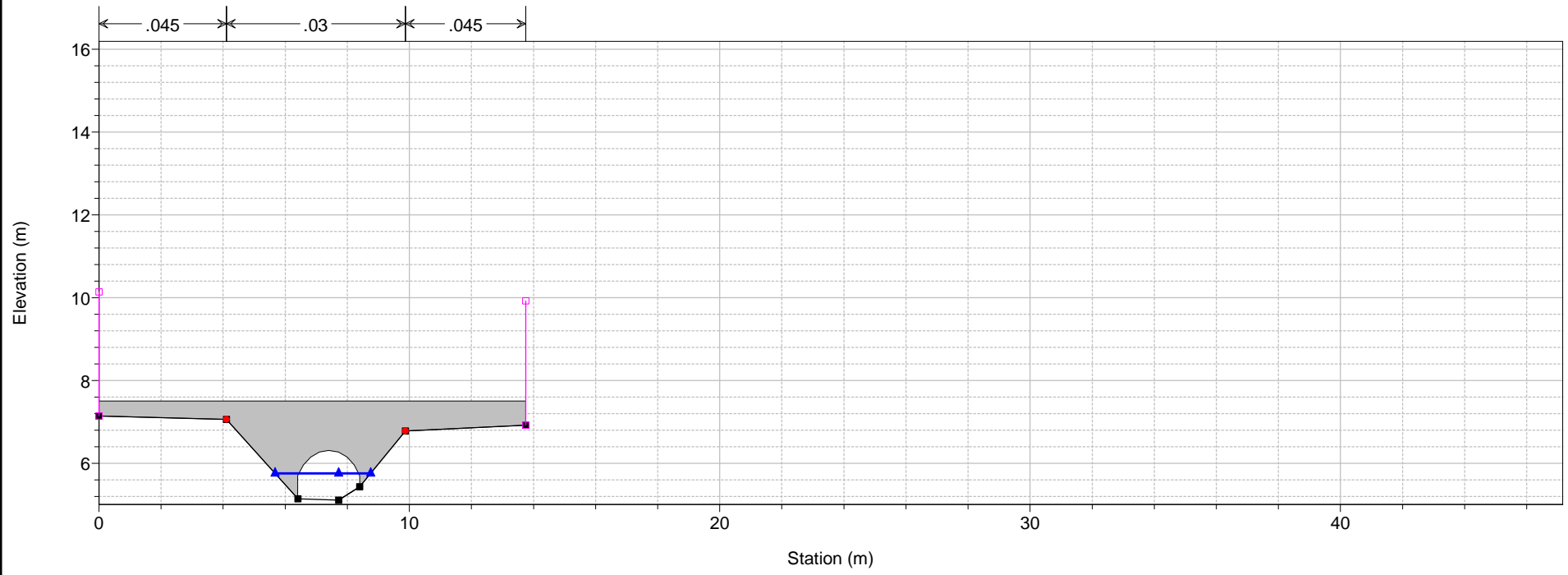

1) A TR 200 2) A TR 30
 River = vallecorsa Reach = vallecorsa RS = 108 Sez. 1v

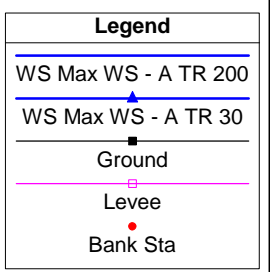
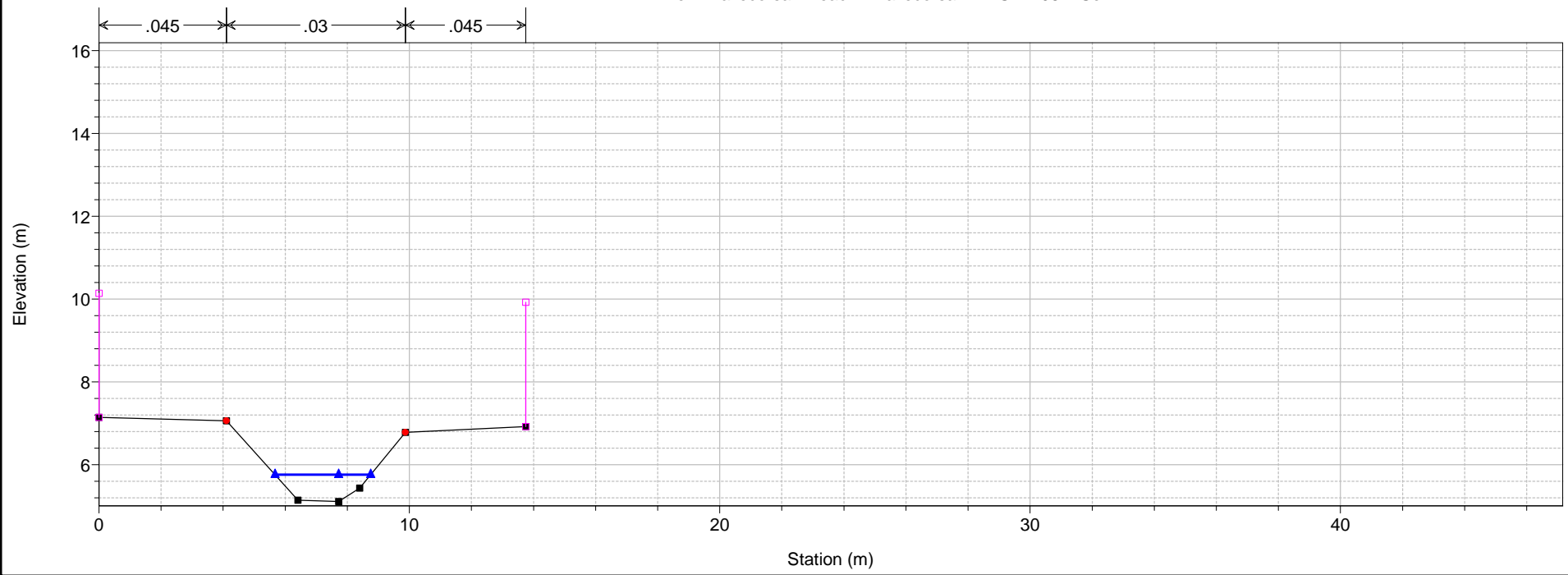

1 cm Horiz. = 2 m 1 cm Vert. = 1.5 m

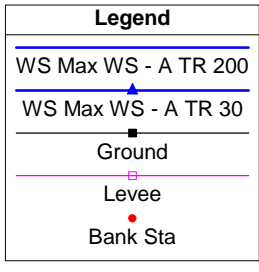
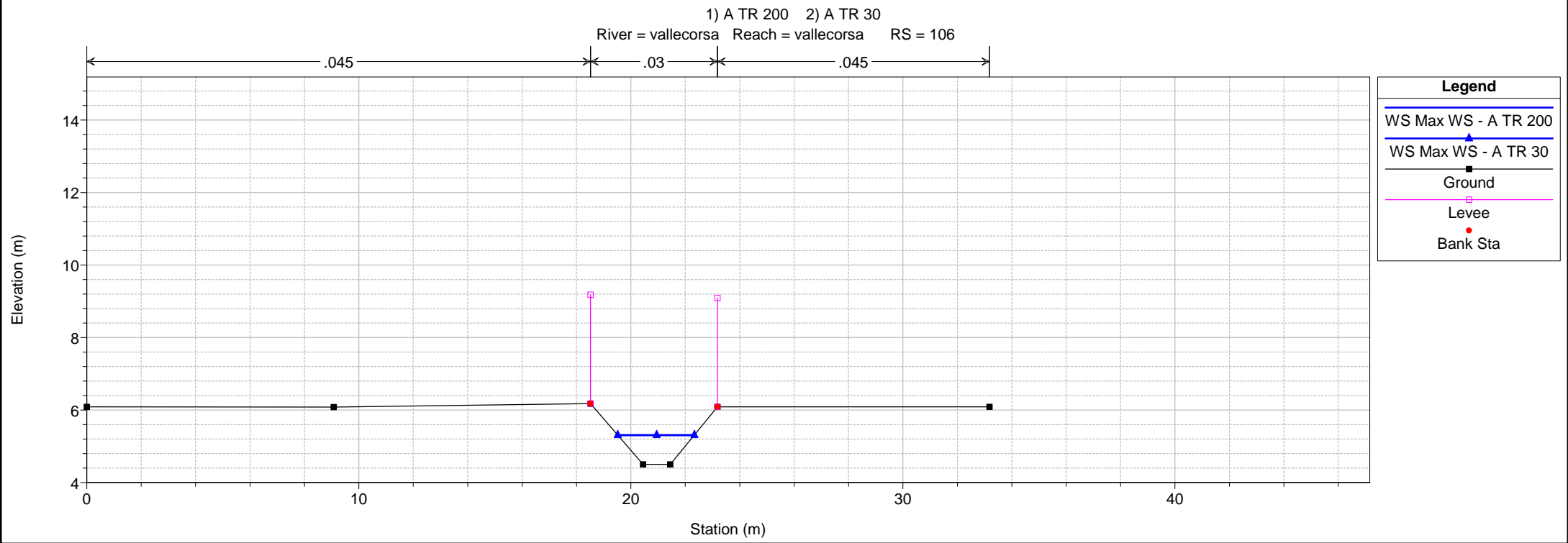
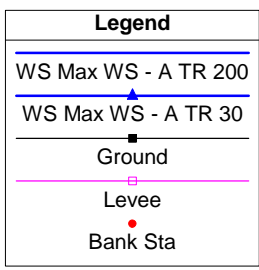
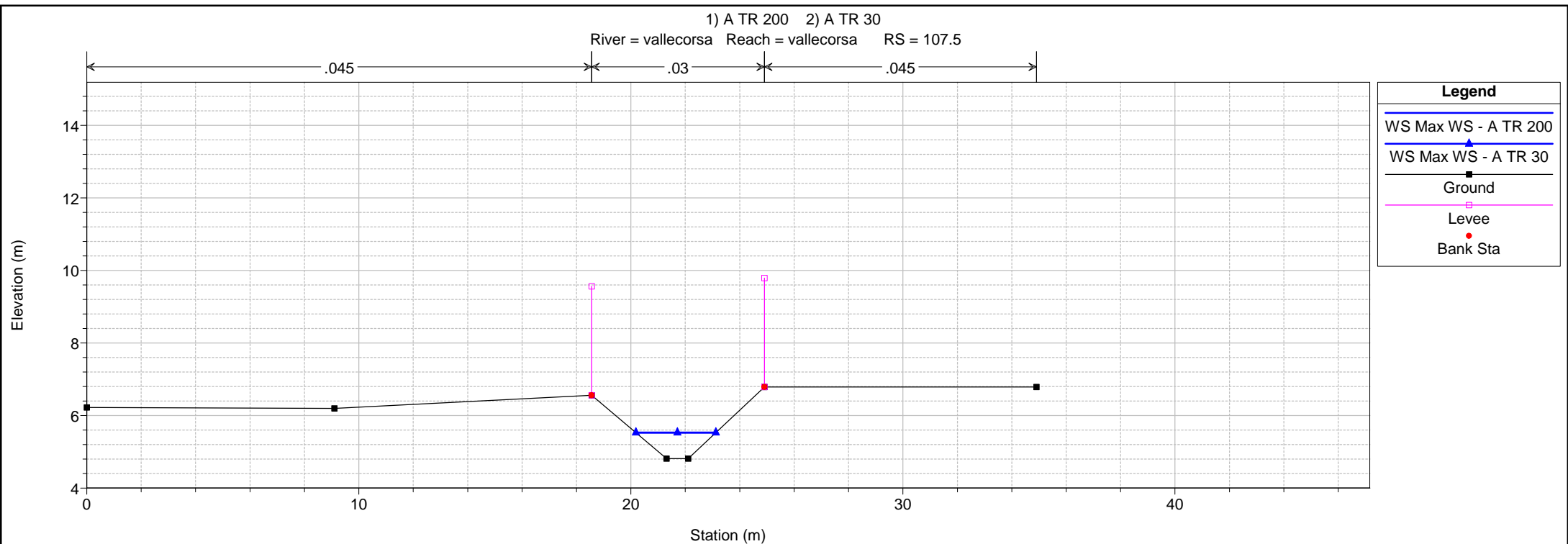

1 cm Horiz. = 2 m 1 cm Vert. = 1.5 m

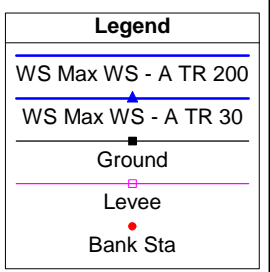
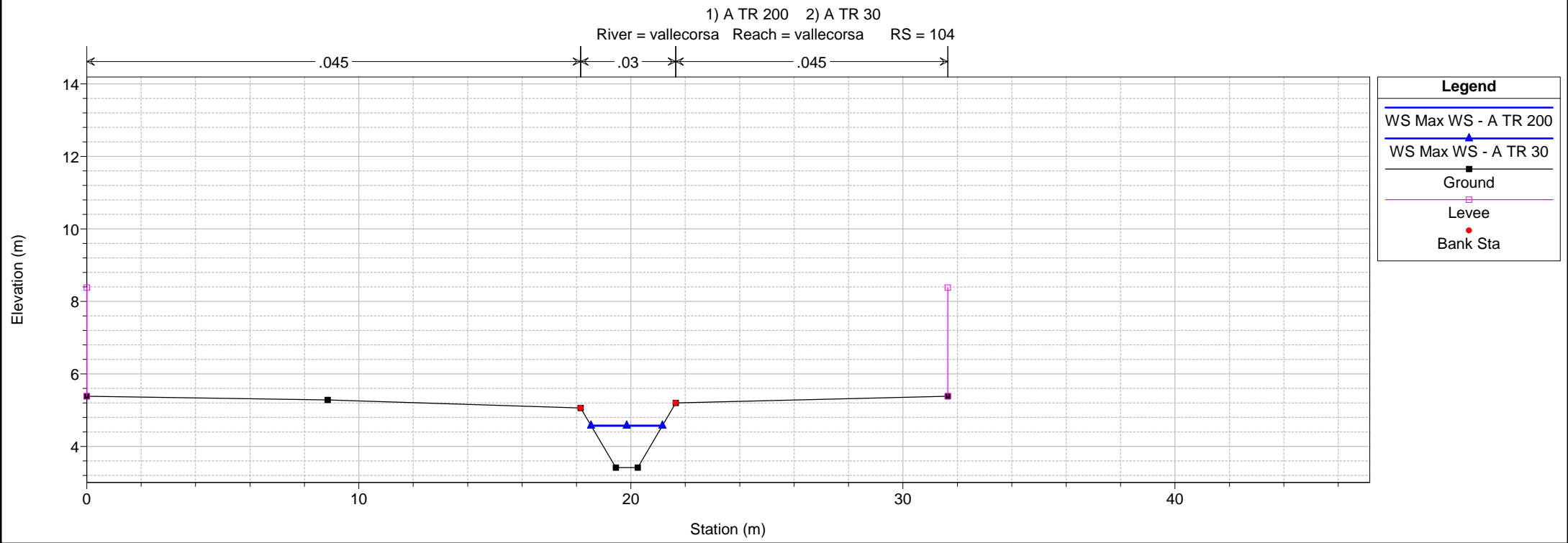
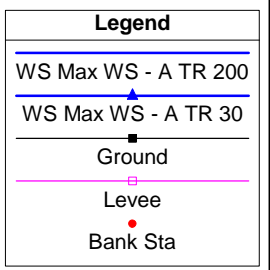
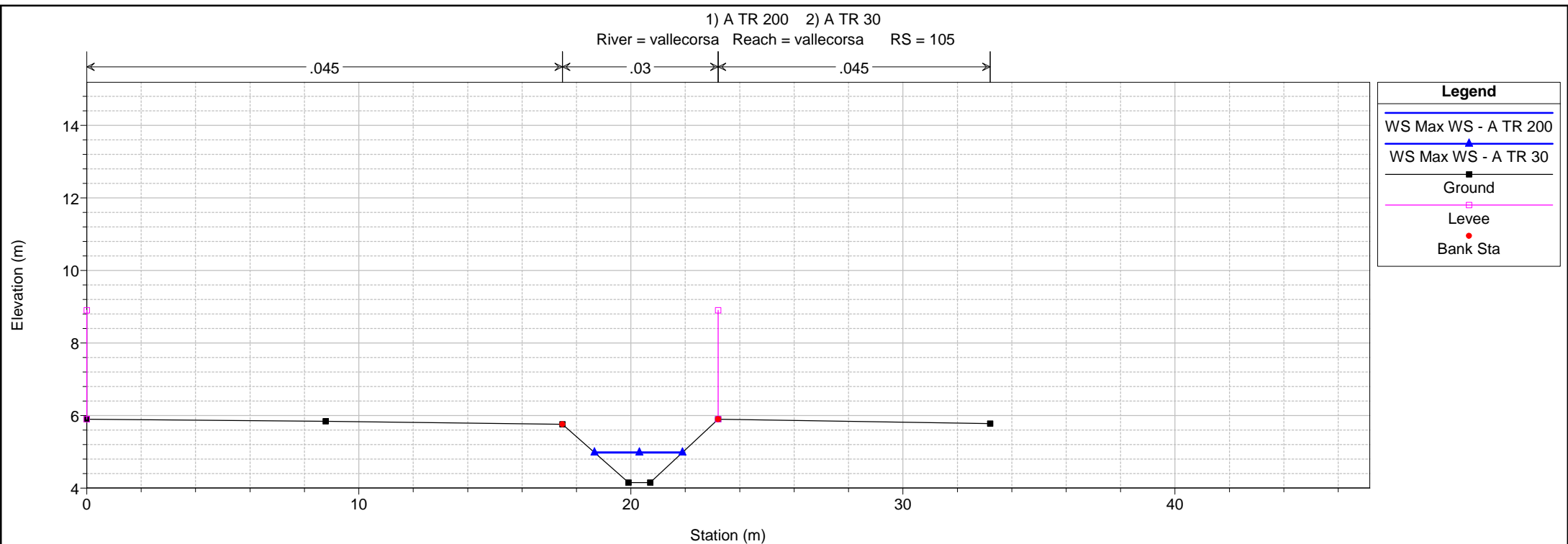

1 cm Horiz. = 2 m 1 cm Vert. = 1.5 m

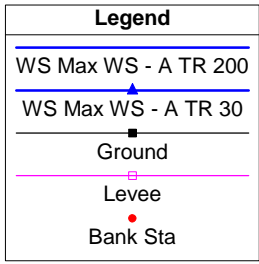
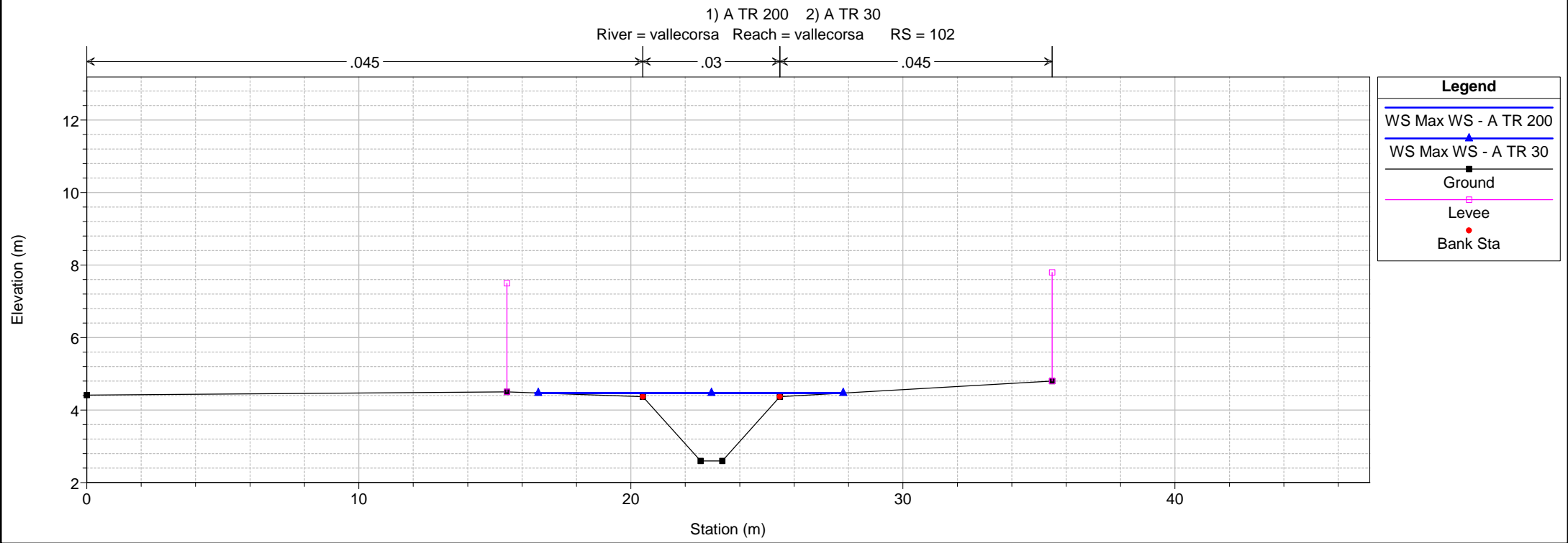
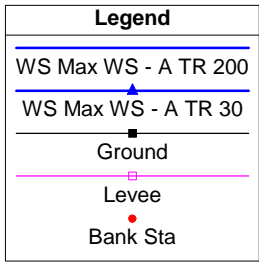
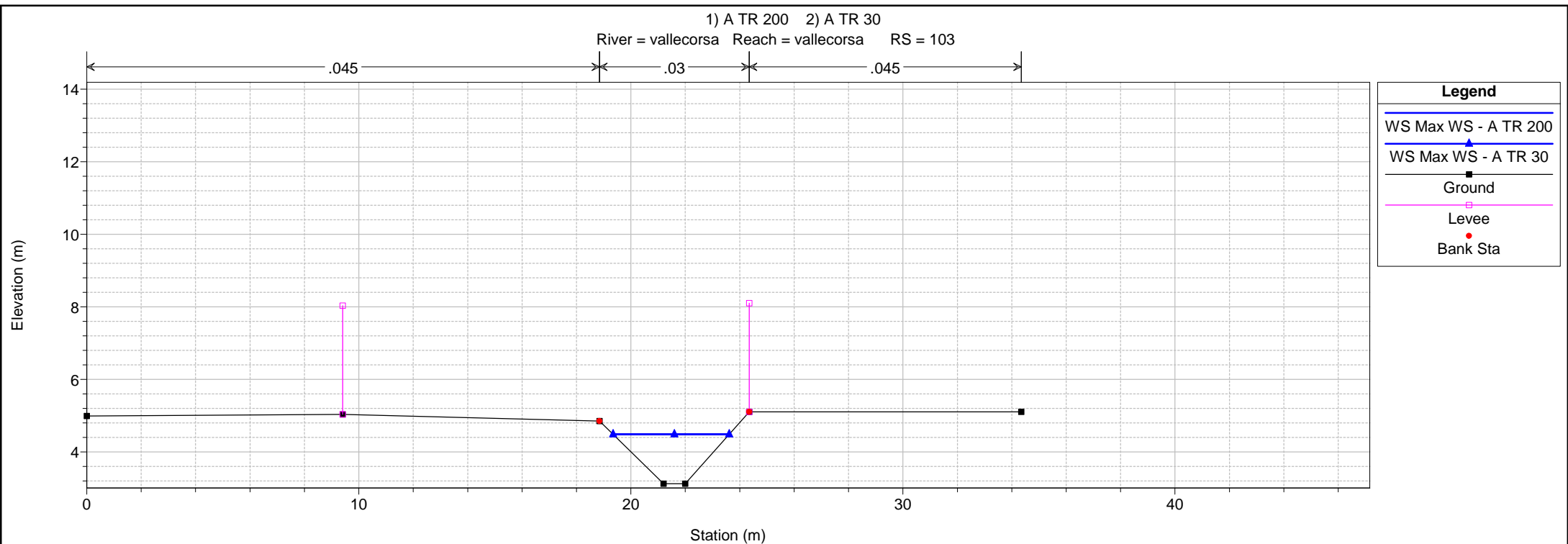

1 cm Horiz. = 2 m 1 cm Vert. = 1.5 m

1) A TR 200 2) A TR 30
 River = vallecorsa Reach = vallecorsa RS = 101.2

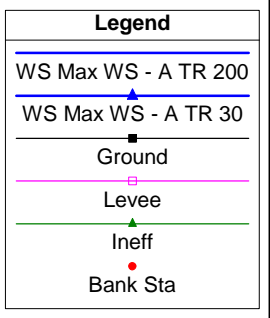
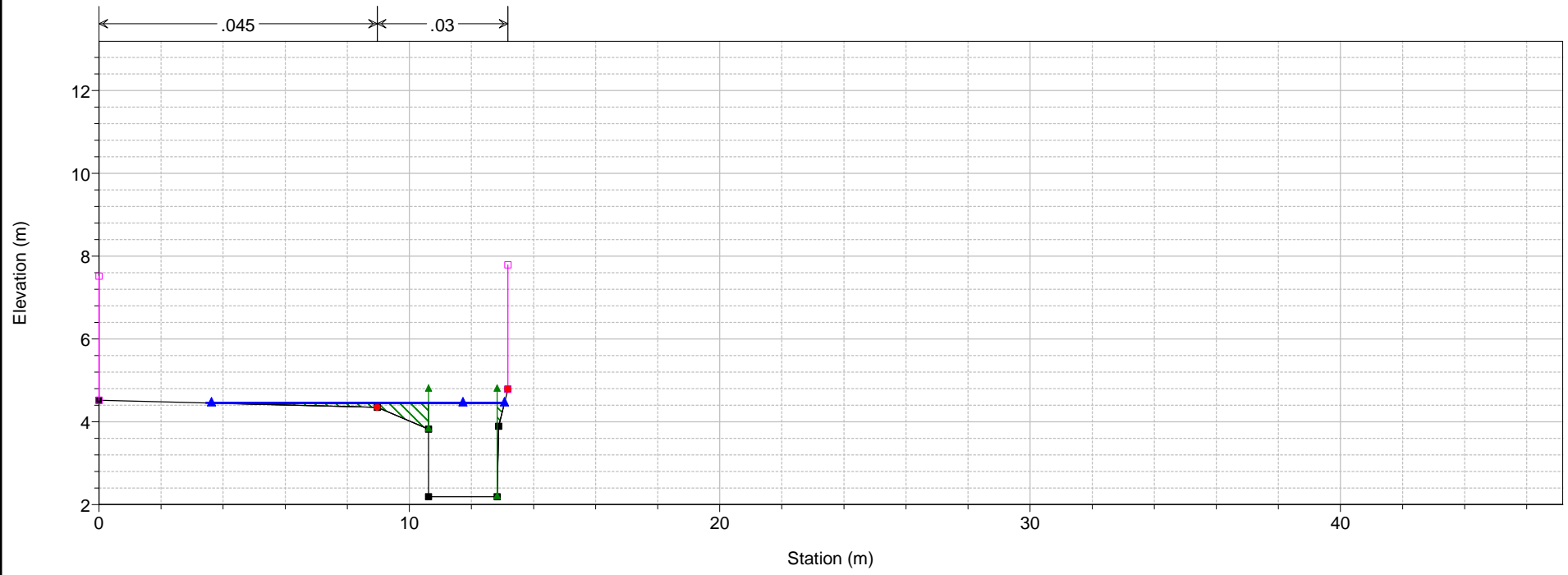

1) A TR 200 2) A TR 30
 River = vallecorsa Reach = valle RS = 101

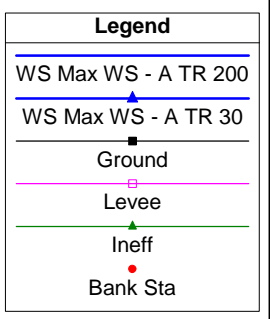
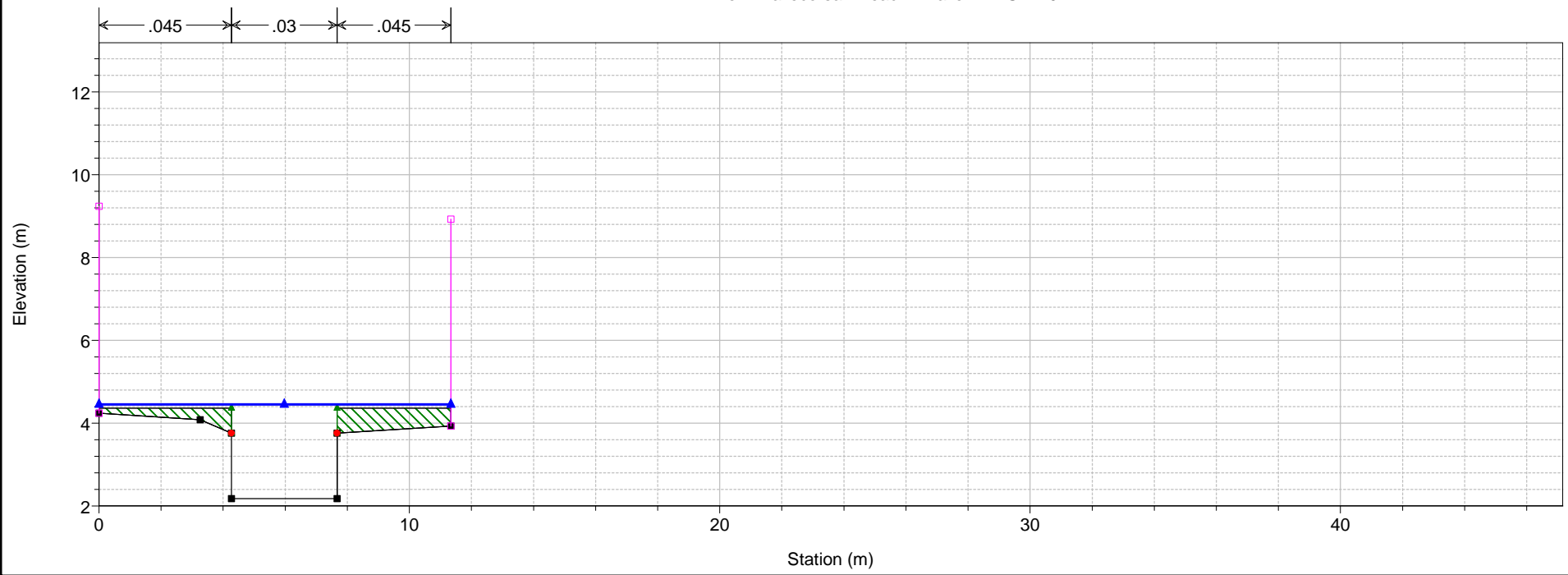

1 cm Horiz. = 2 m 1 cm Vert. = 1.5 m

1) A TR 200 2) A TR 30
River = vallecorsa Reach = valle RS = 100.7

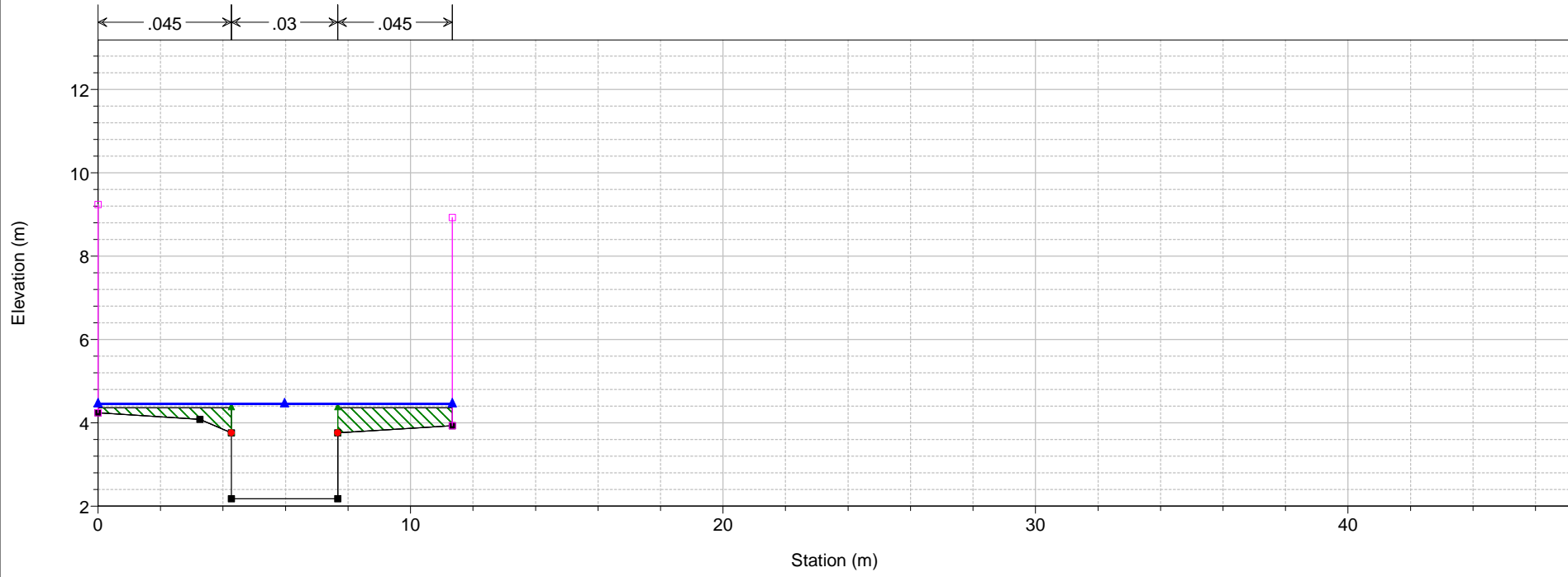

1) A TR 200 2) A TR 30
River = vallecorsa Reach = valle RS = 100.5 BR

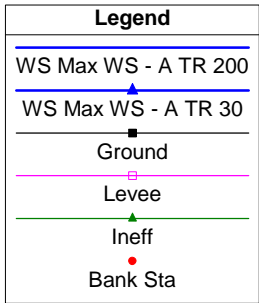
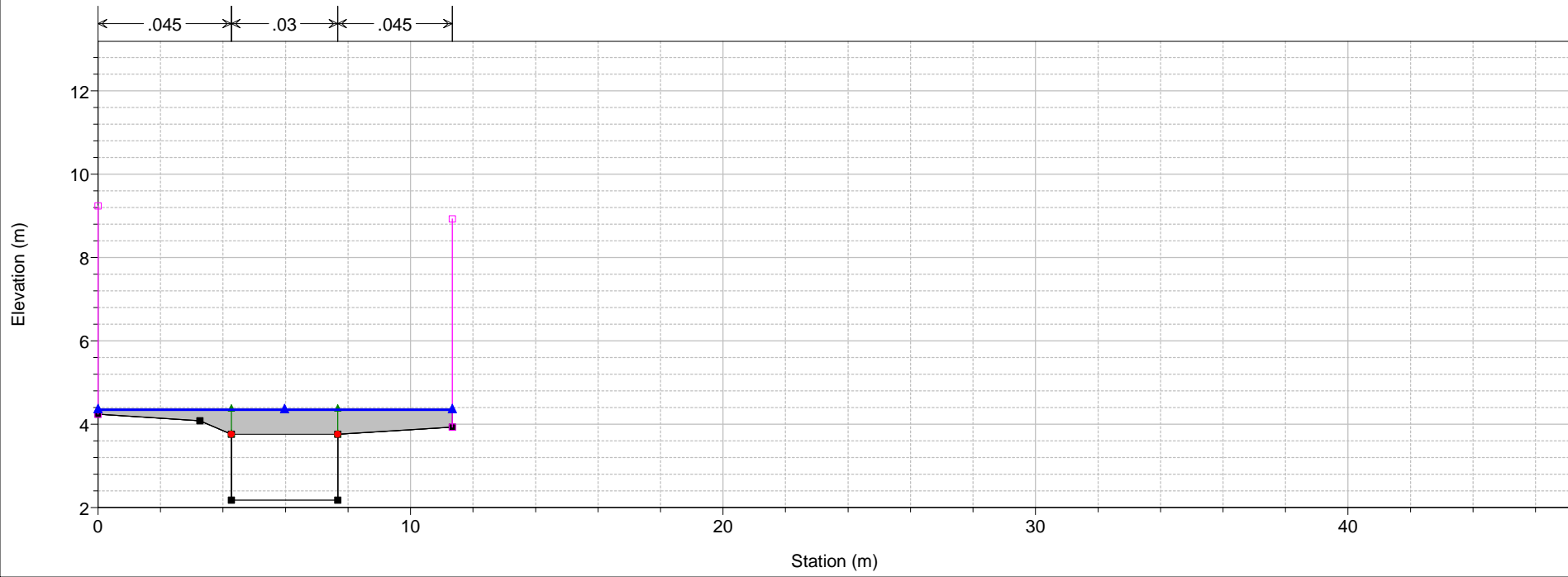

1 cm Horiz. = 2 m 1 cm Vert. = 1.5 m

1) A TR 200 2) A TR 30
 River = vallecorsa Reach = valle RS = 100.5 BR

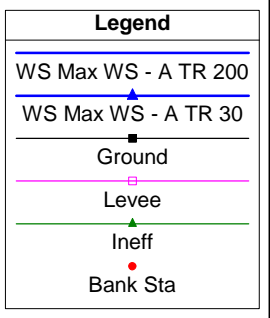
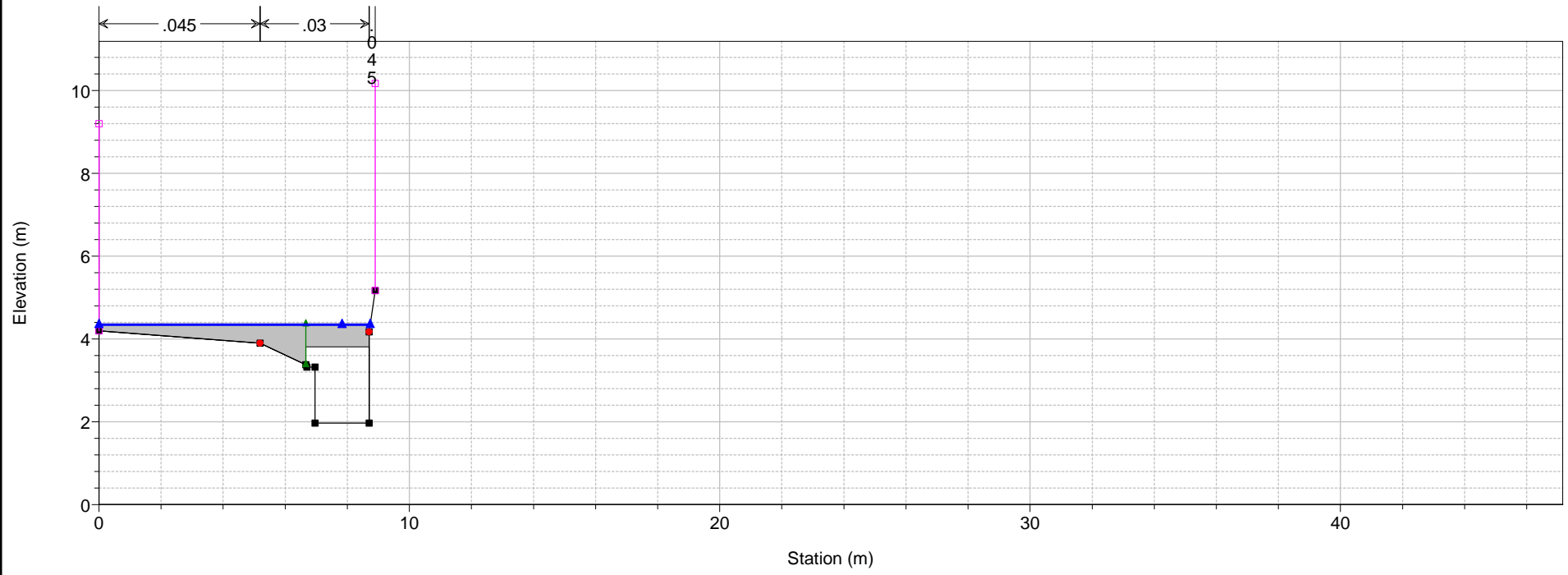

1) A TR 200 2) A TR 30
 River = vallecorsa Reach = valle RS = 100

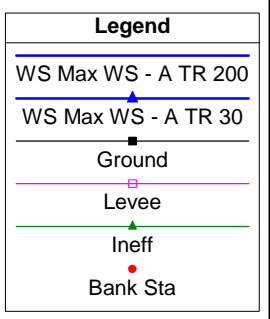
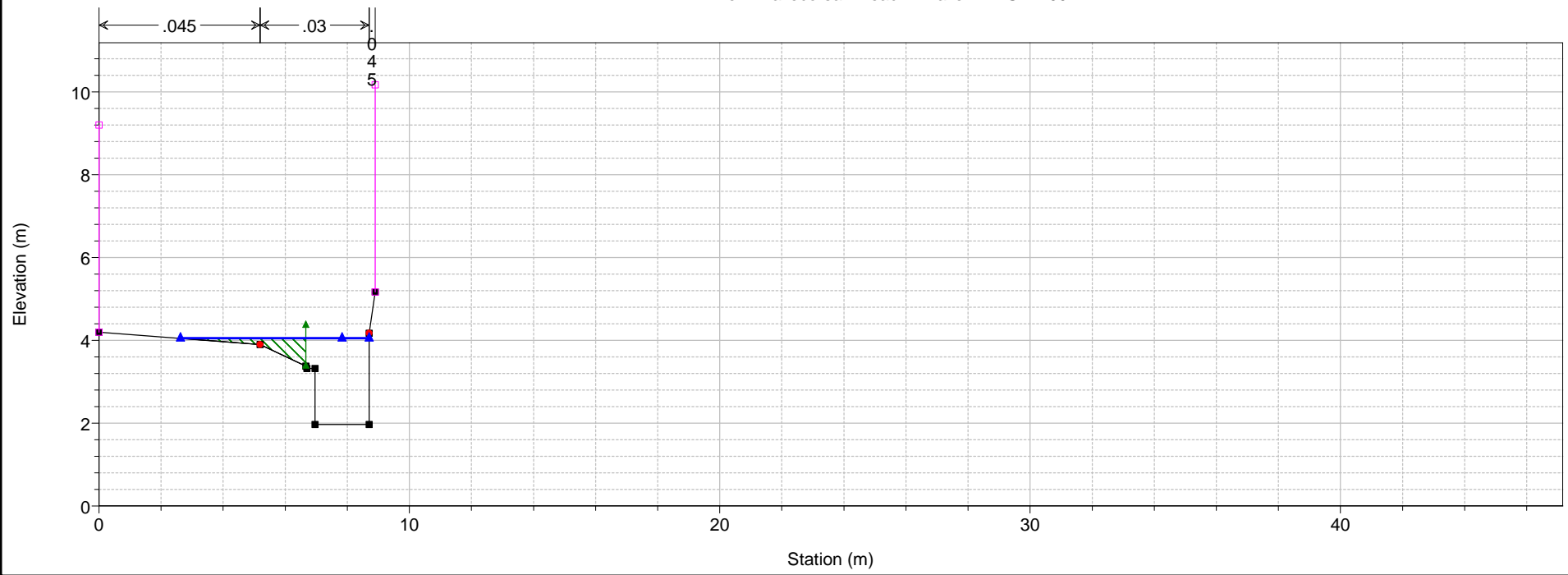

1 cm Horiz. = 2 m 1 cm Vert. = 1.5 m

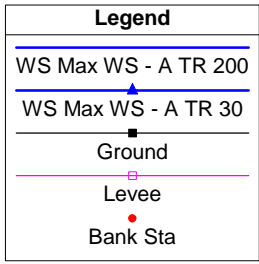
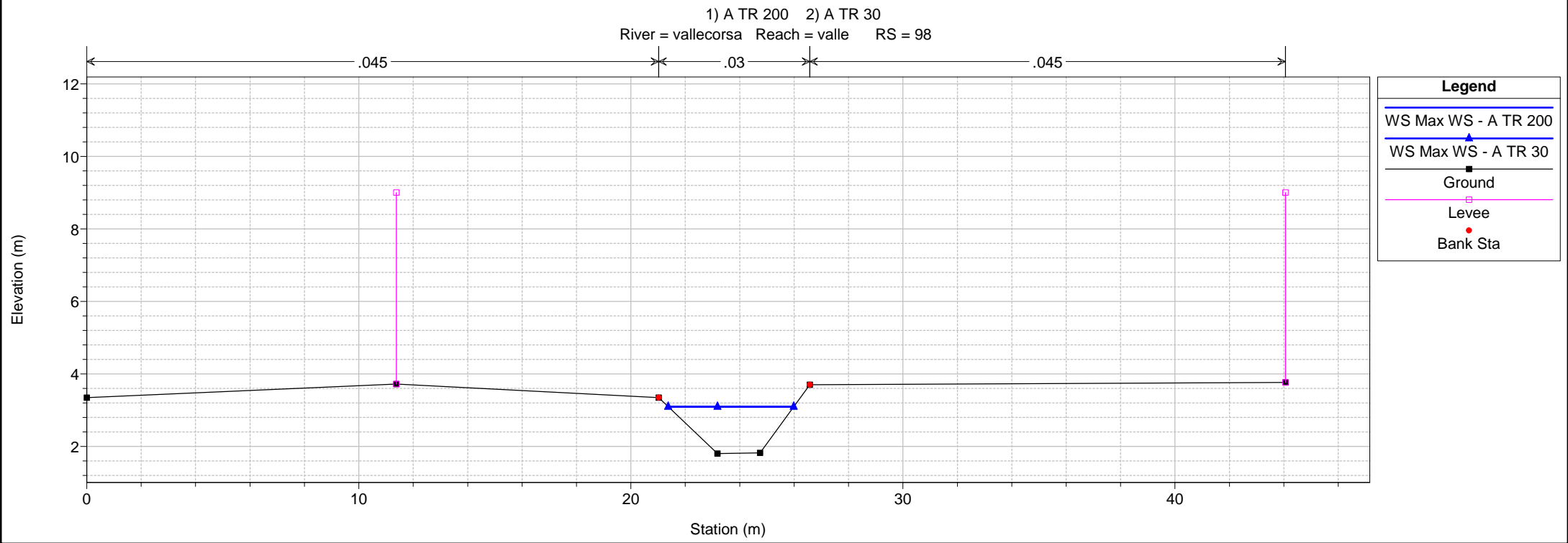
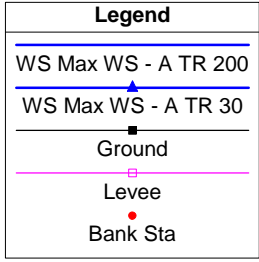
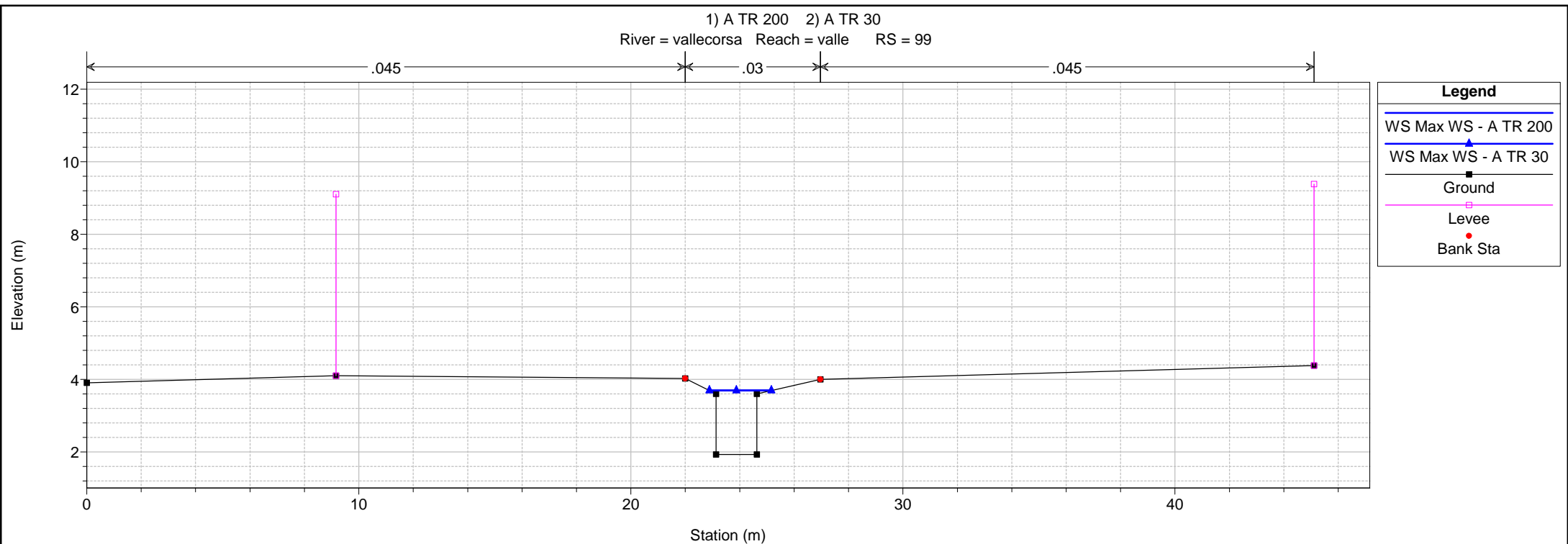

1 cm Horiz. = 2 m 1 cm Vert. = 1.5 m

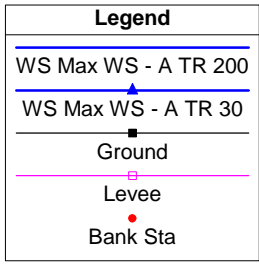
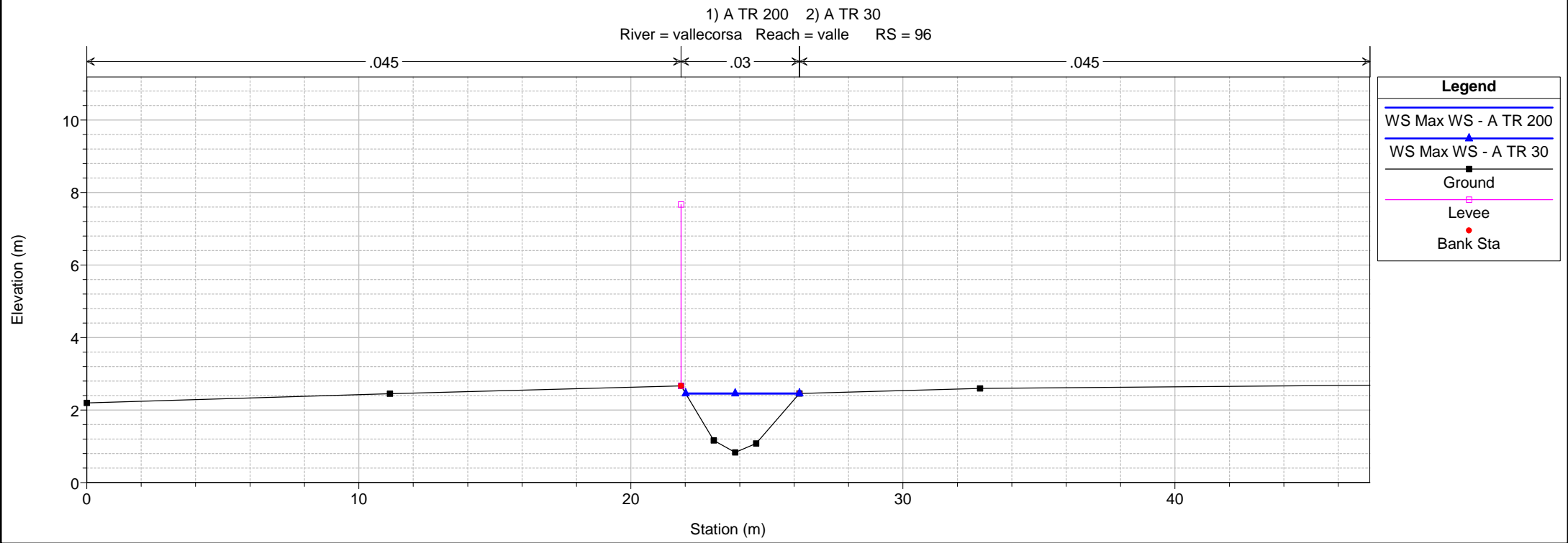
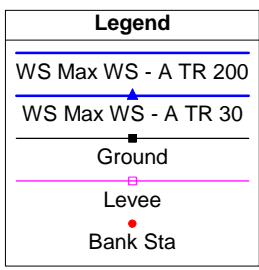
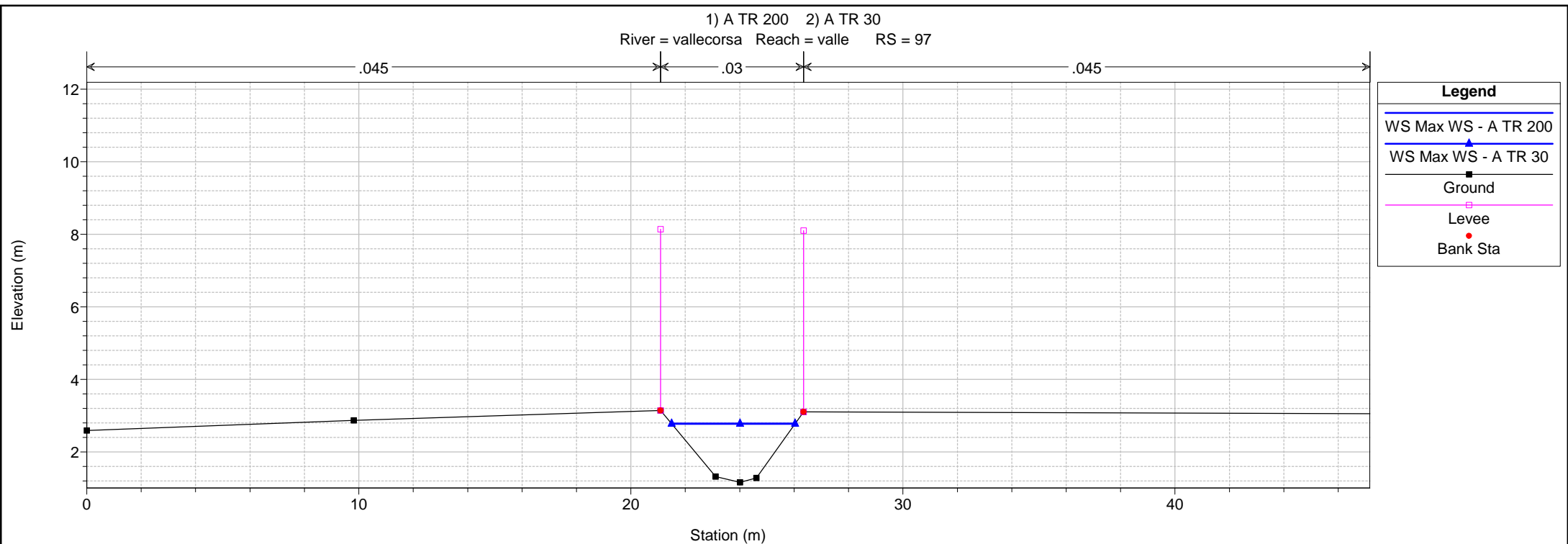

1 cm Horiz. = 2 m 1 cm Vert. = 1.5 m

1) A TR 200 2) A TR 30
 River = vallecorsa Reach = valle RS = 95

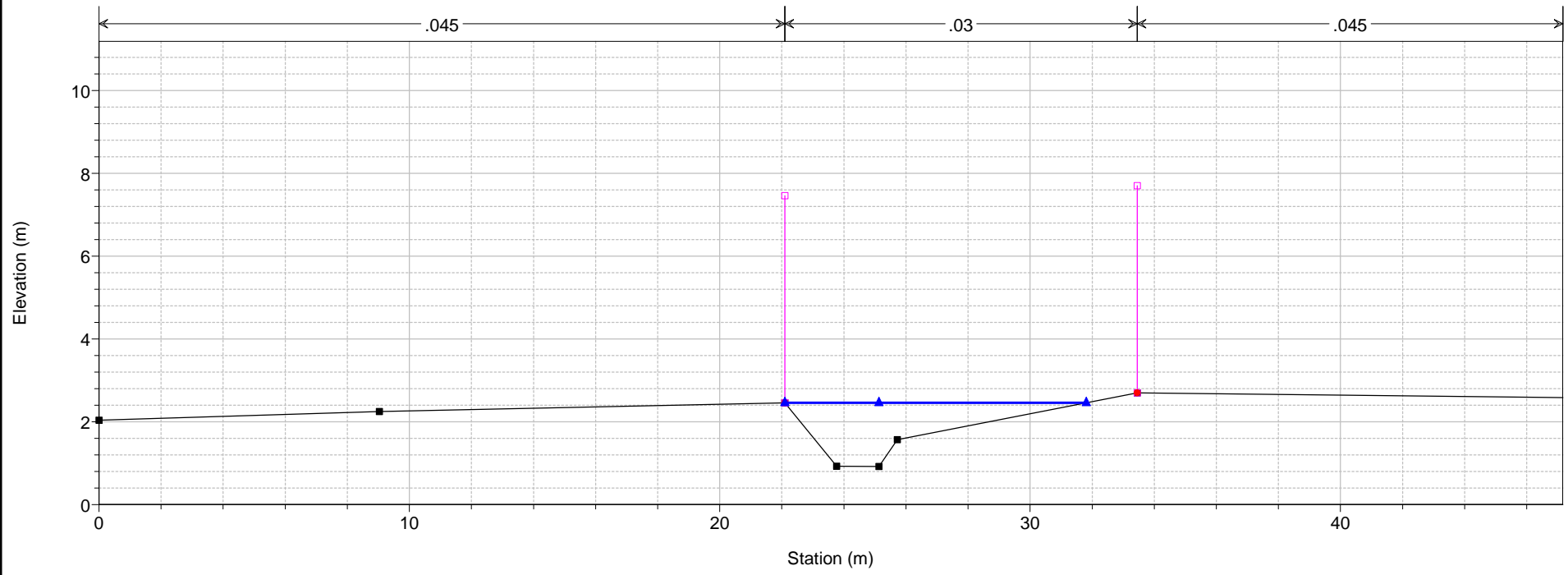

Legend

- WS Max WS - A TR 200
- WS Max WS - A TR 30
- Ground
- Levee
- Bank Sta

1) A TR 200 2) A TR 30
 River = vallecorsa Reach = valle RS = 94

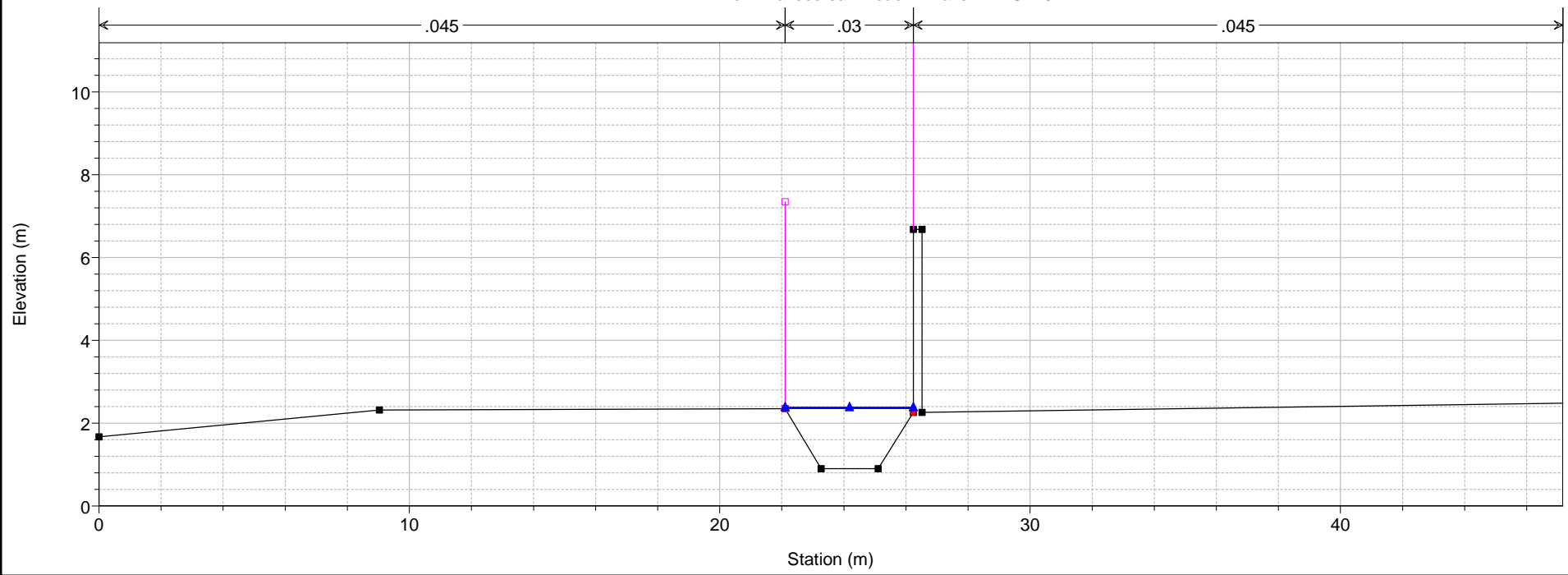

Legend

- WS Max WS - A TR 200
- WS Max WS - A TR 30
- Ground
- Levee
- Bank Sta

1 cm Horiz. = 2 m 1 cm Vert. = 1.5 m

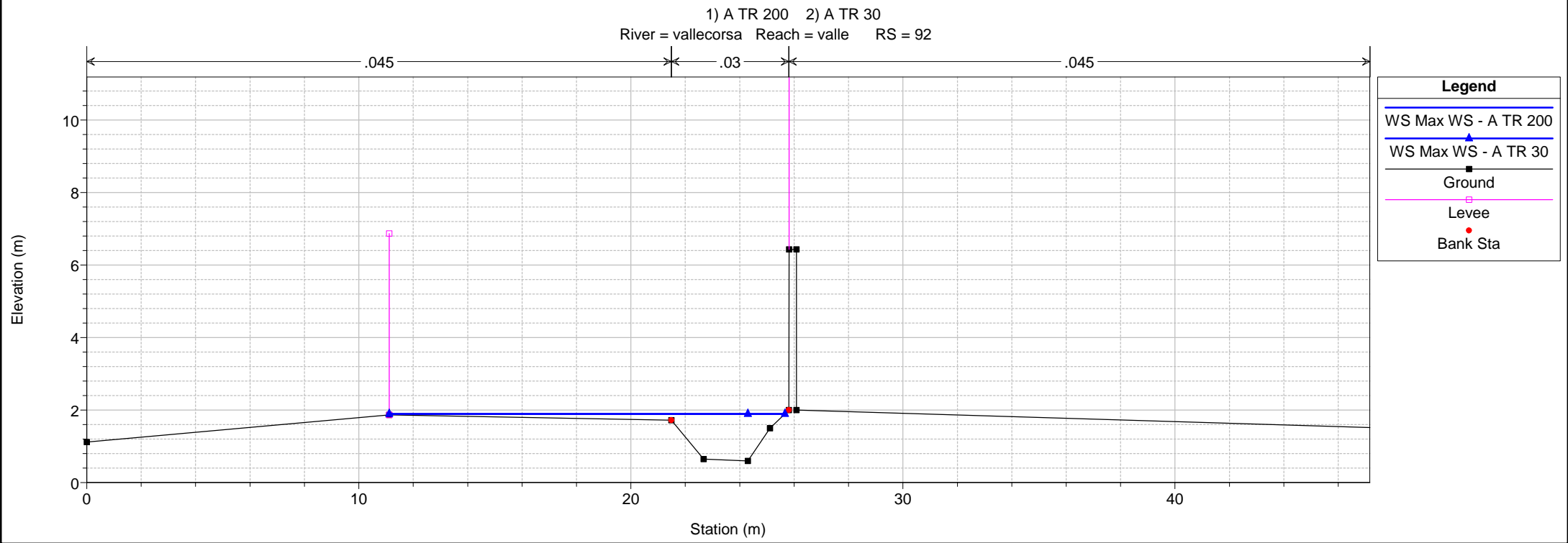
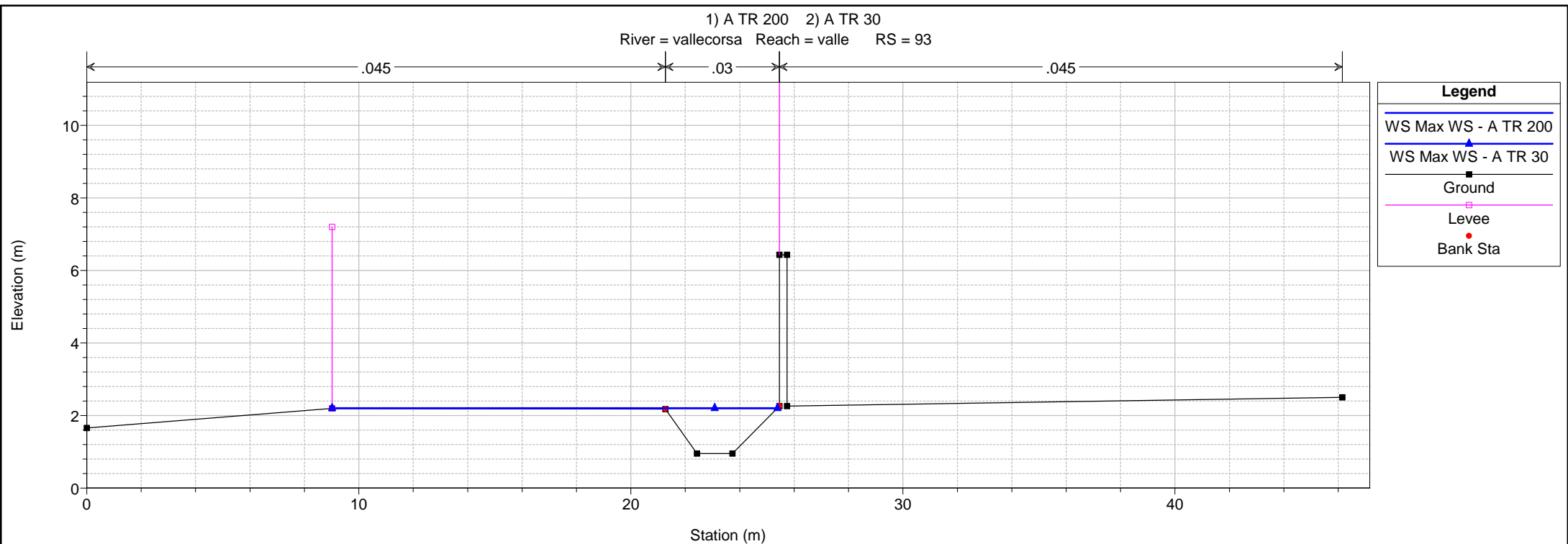

1 cm Horiz. = 2 m 1 cm Vert. = 1.5 m

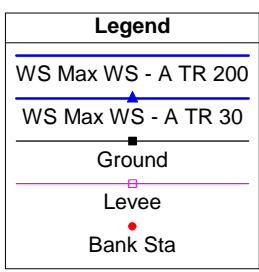
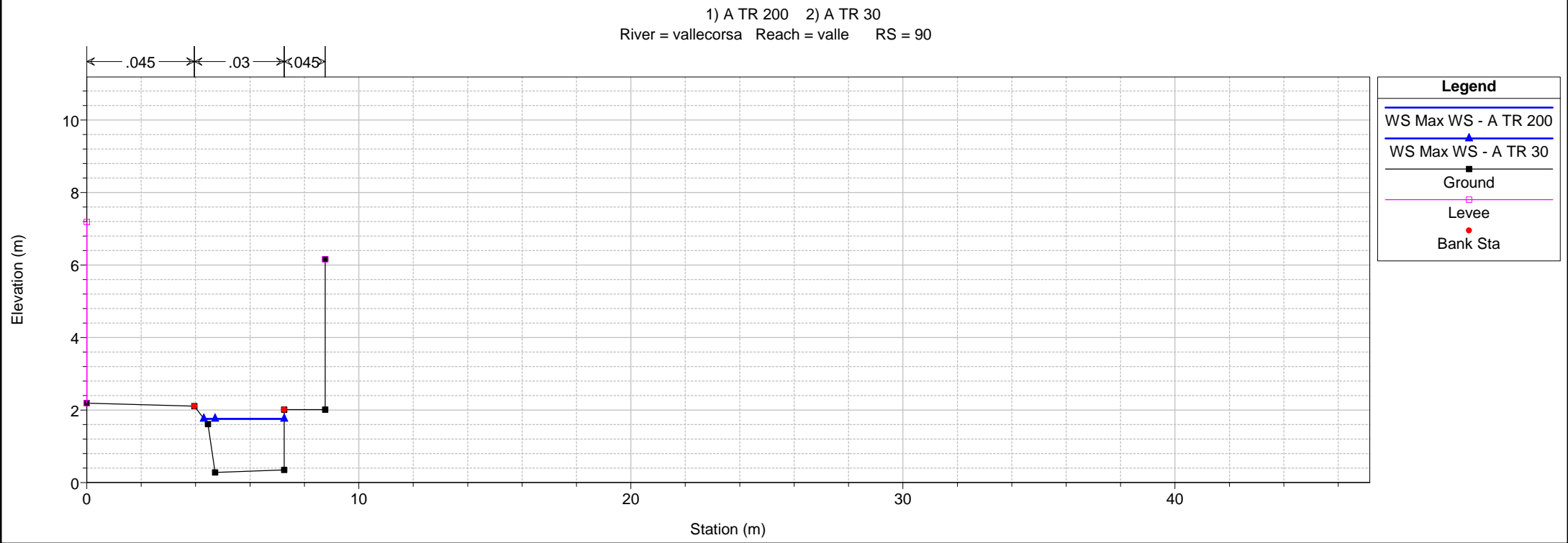
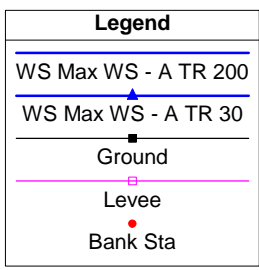
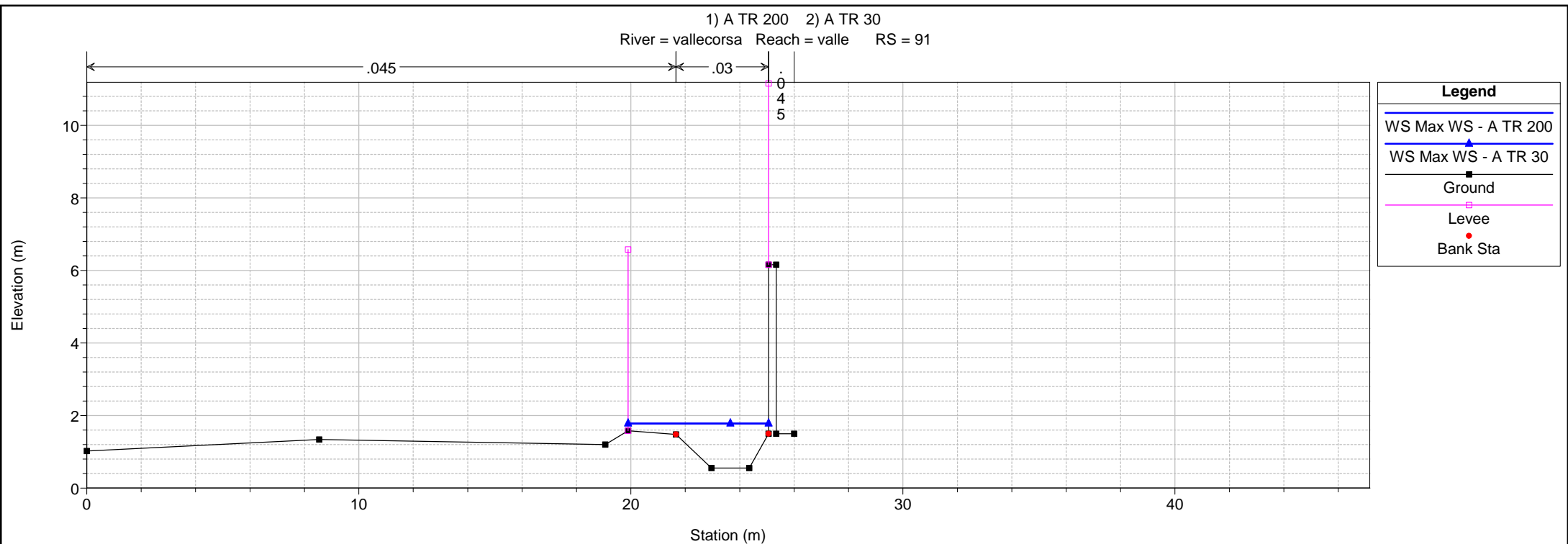

1 cm Horiz. = 2 m 1 cm Vert. = 1.5 m

1) A TR 200 2) A TR 30
 River = vallecorsa Reach = valle RS = 89.5 BR

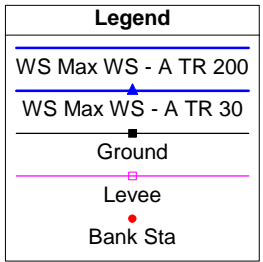
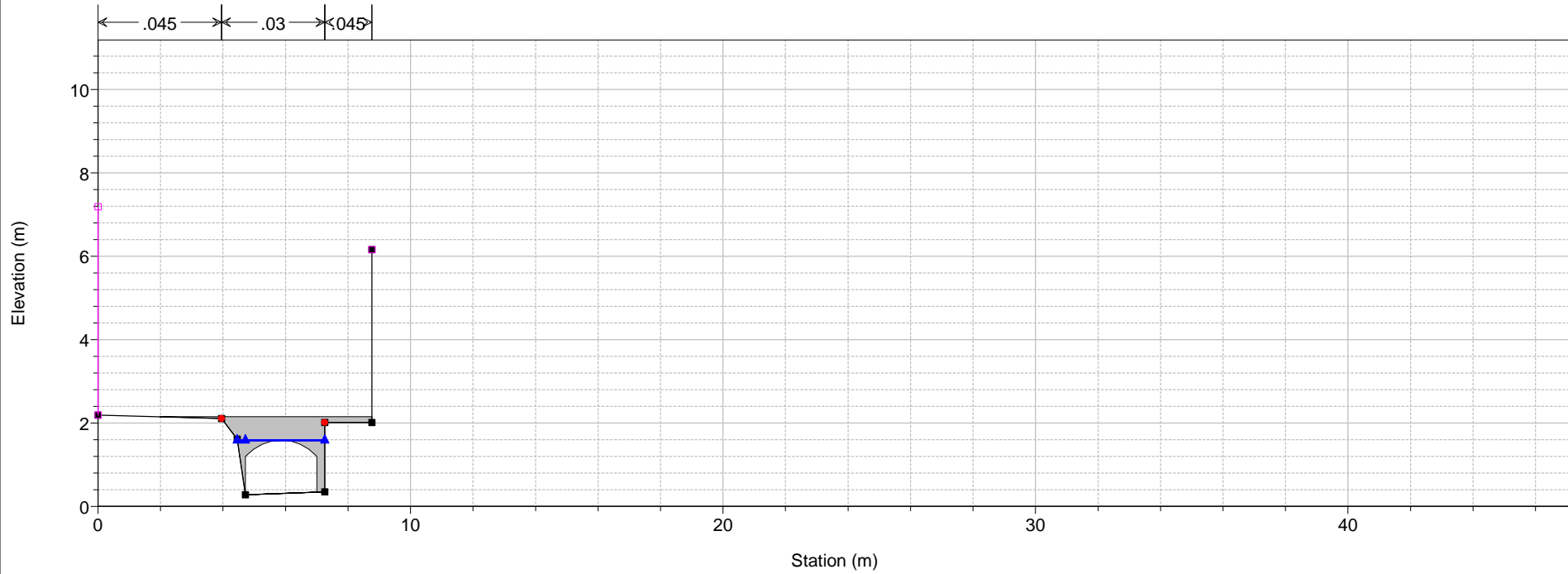

1) A TR 200 2) A TR 30
 River = vallecorsa Reach = valle RS = 89.5 BR

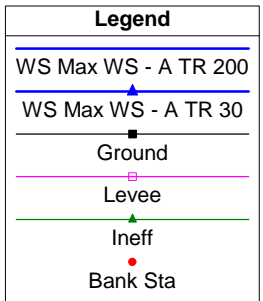
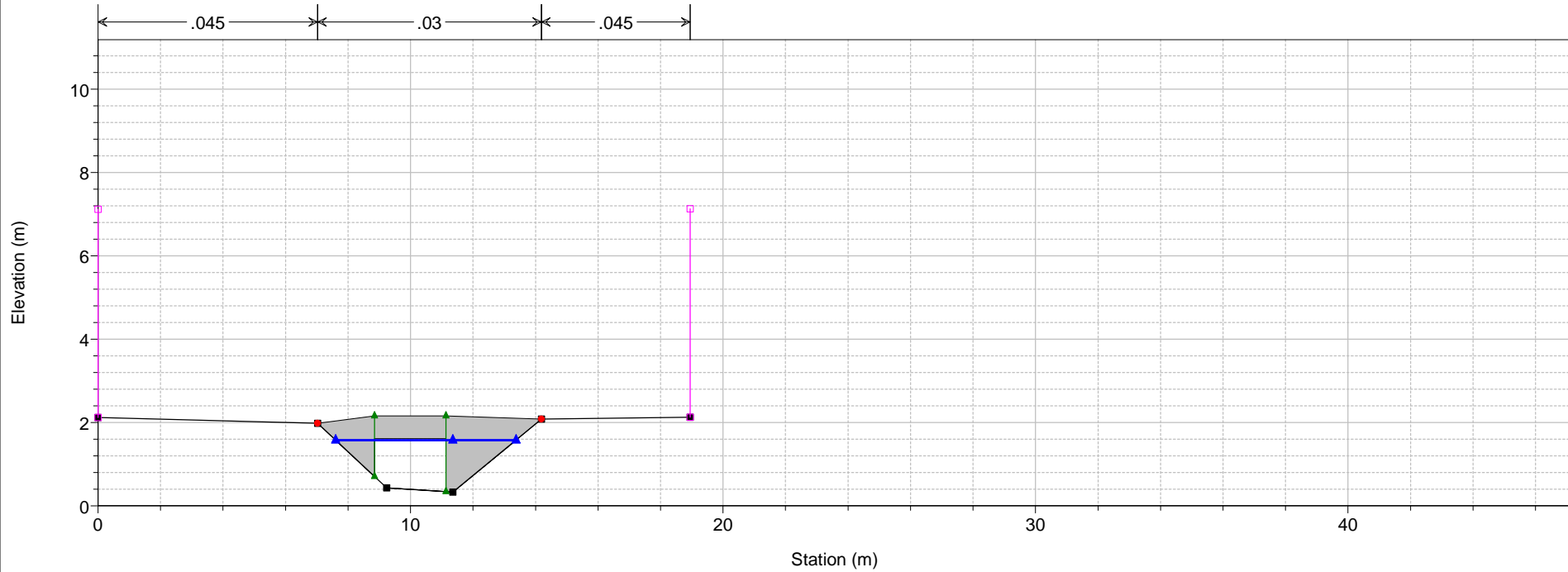

1 cm Horiz. = 2 m 1 cm Vert. = 1.5 m

1) A TR 200 2) A TR 30
 River = vallecorsa Reach = valle RS = 89

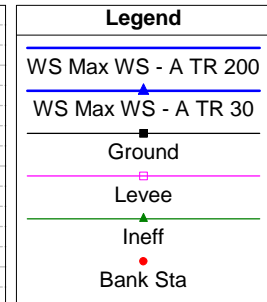
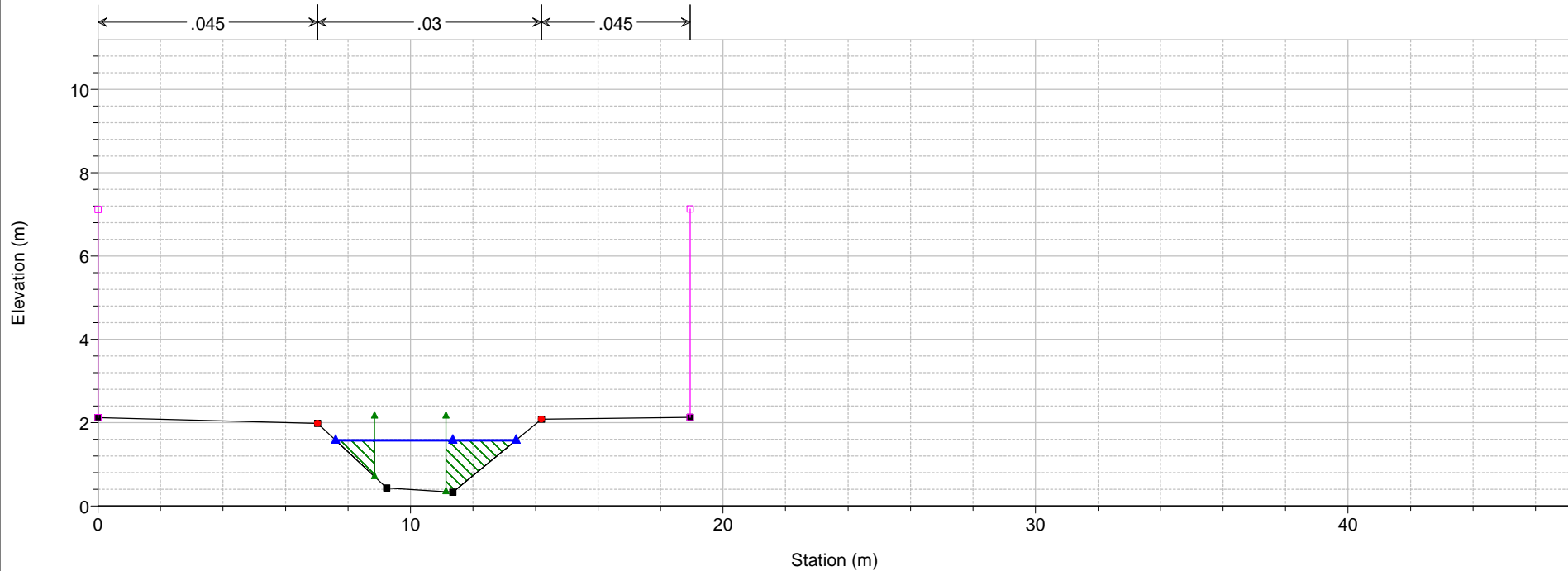

1) A TR 200 2) A TR 30
 River = vallecorsa Reach = valle RS = 88 27.64

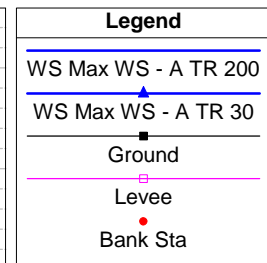
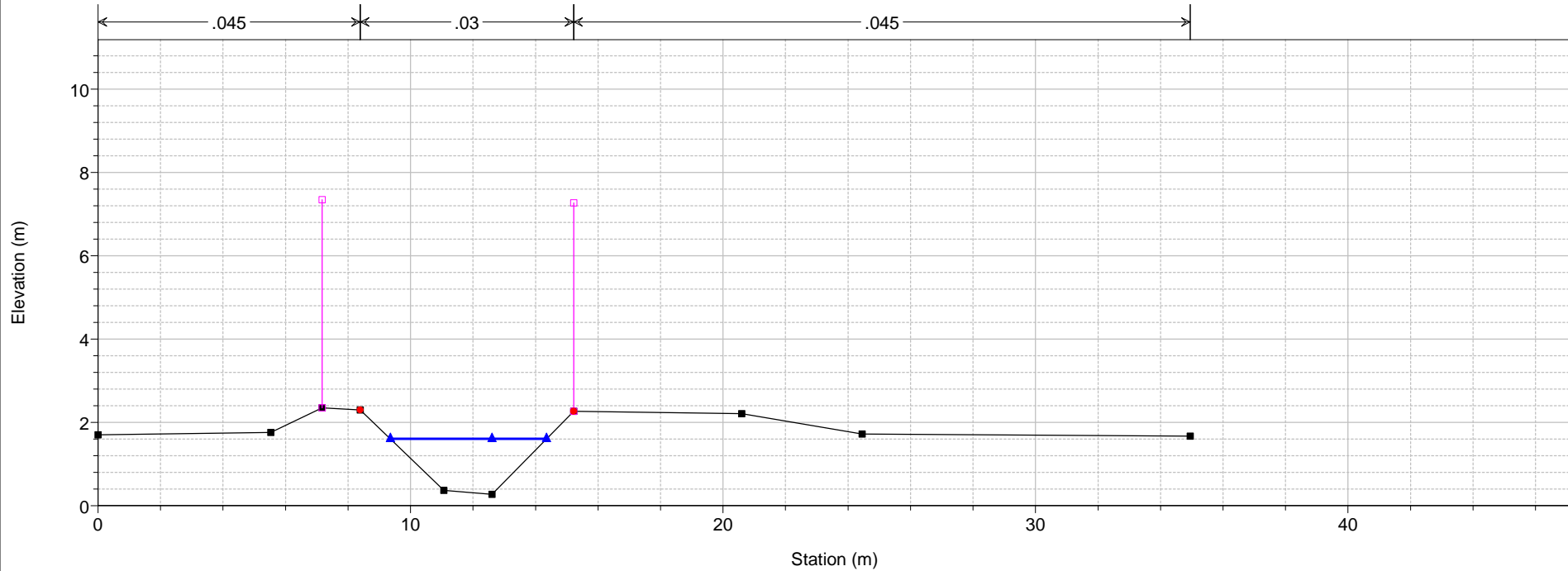

1) A TR 200 2) A TR 30
 River = vallecorsa Reach = valle RS = 87

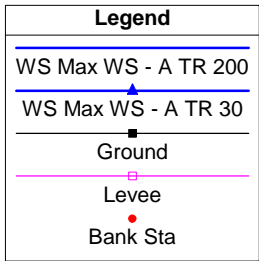
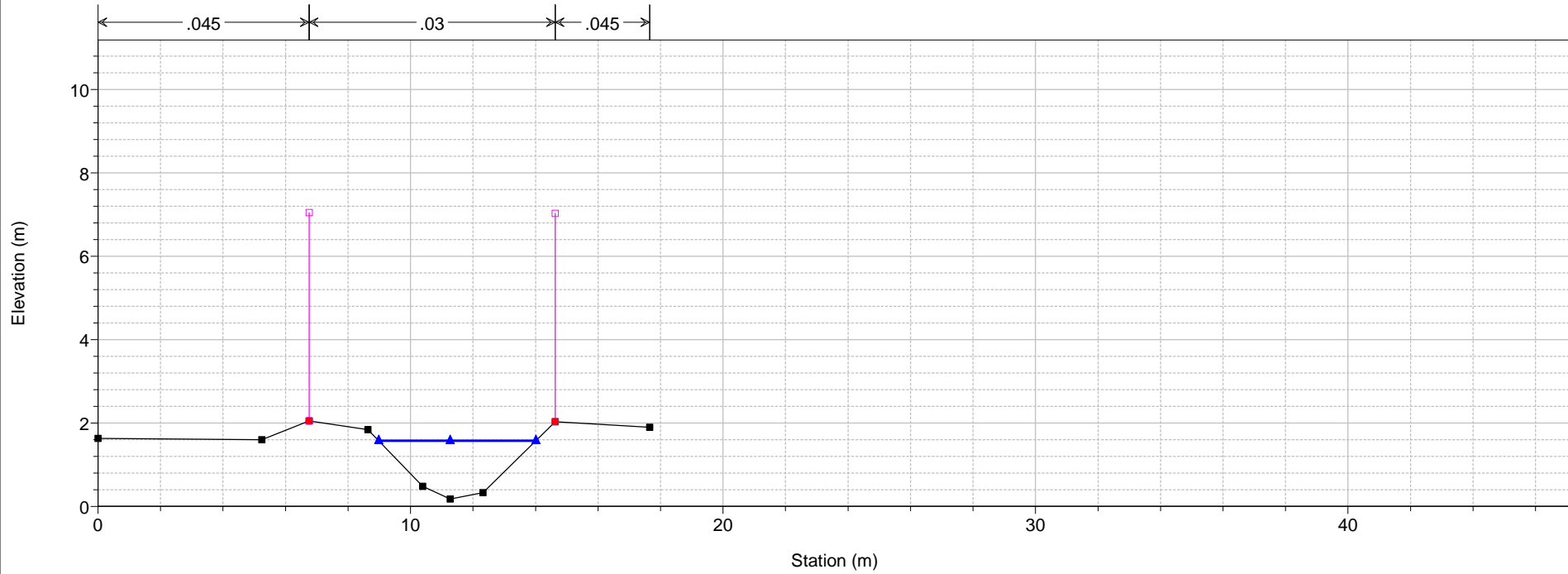

1) A TR 200 2) A TR 30
 River = vallecorsa Reach = valle RS = 86

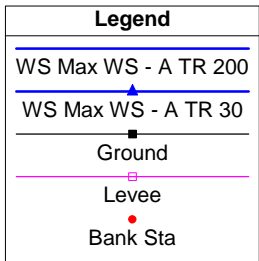
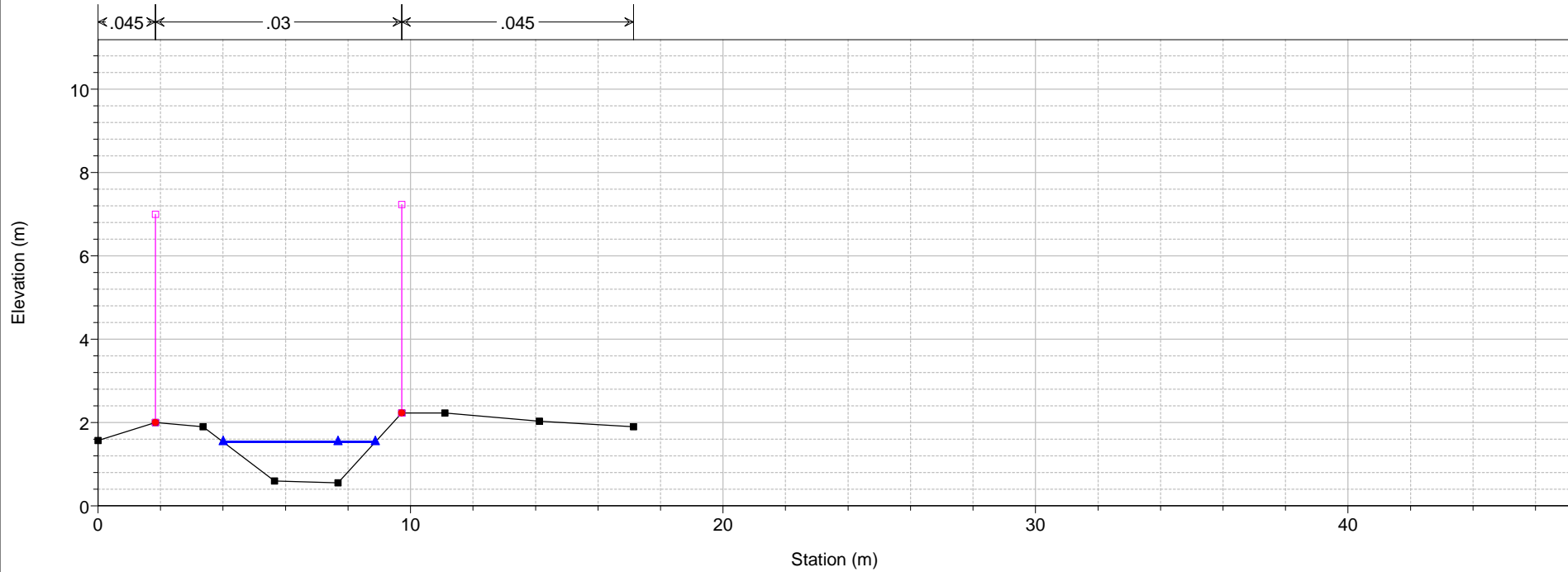

1) A TR 200 2) A TR 30
 River = vallecorsa Reach = valle RS = 85

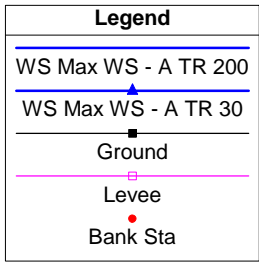
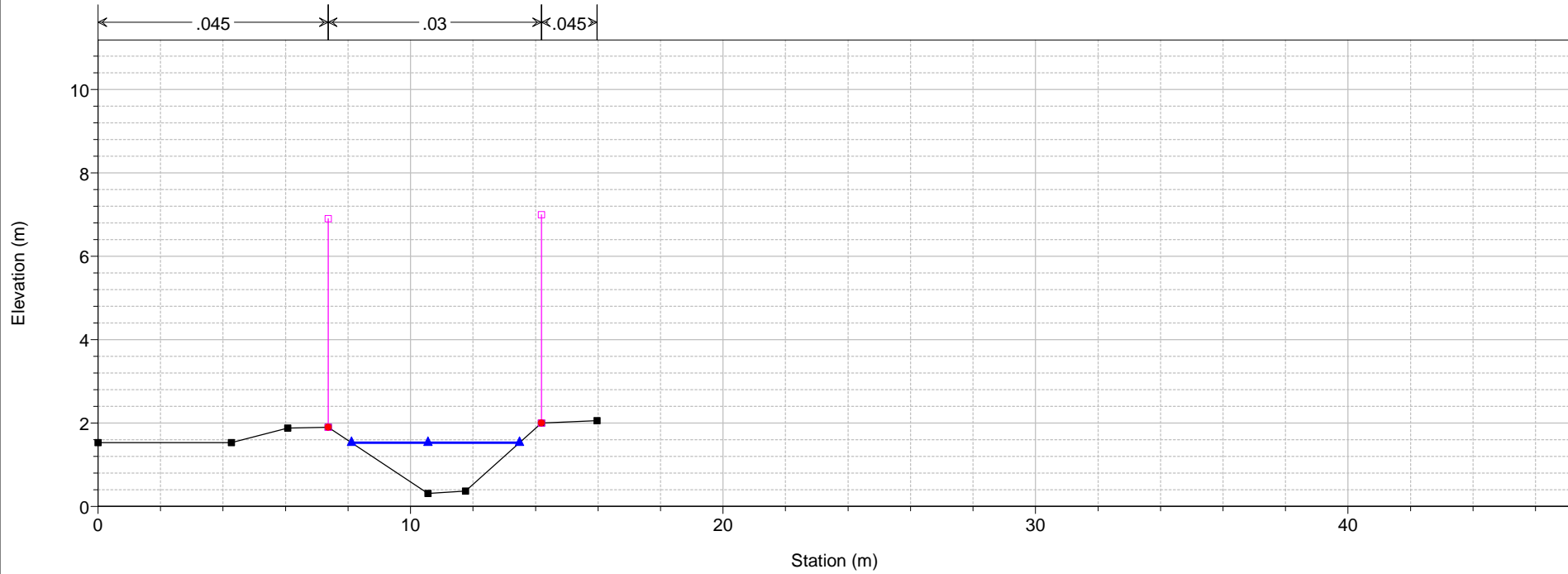

1) A TR 200 2) A TR 30
 River = vallecorsa Reach = valle RS = 84

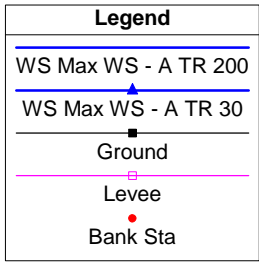
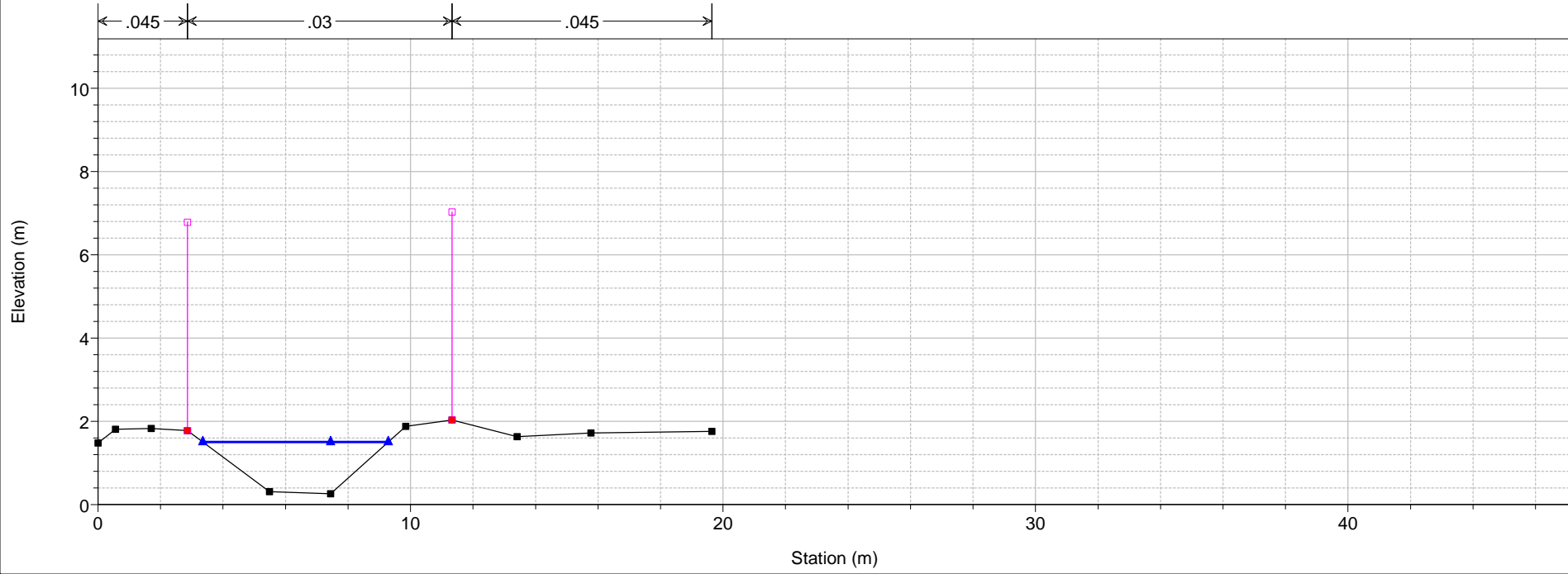

1 cm Horiz. = 2 m 1 cm Vert. = 1.5 m

1) A TR 200 2) A TR 30
River = vallecorsa Reach = valle RS = 83

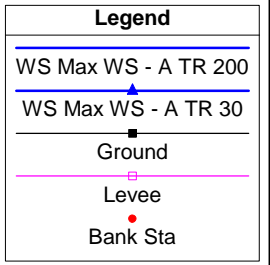
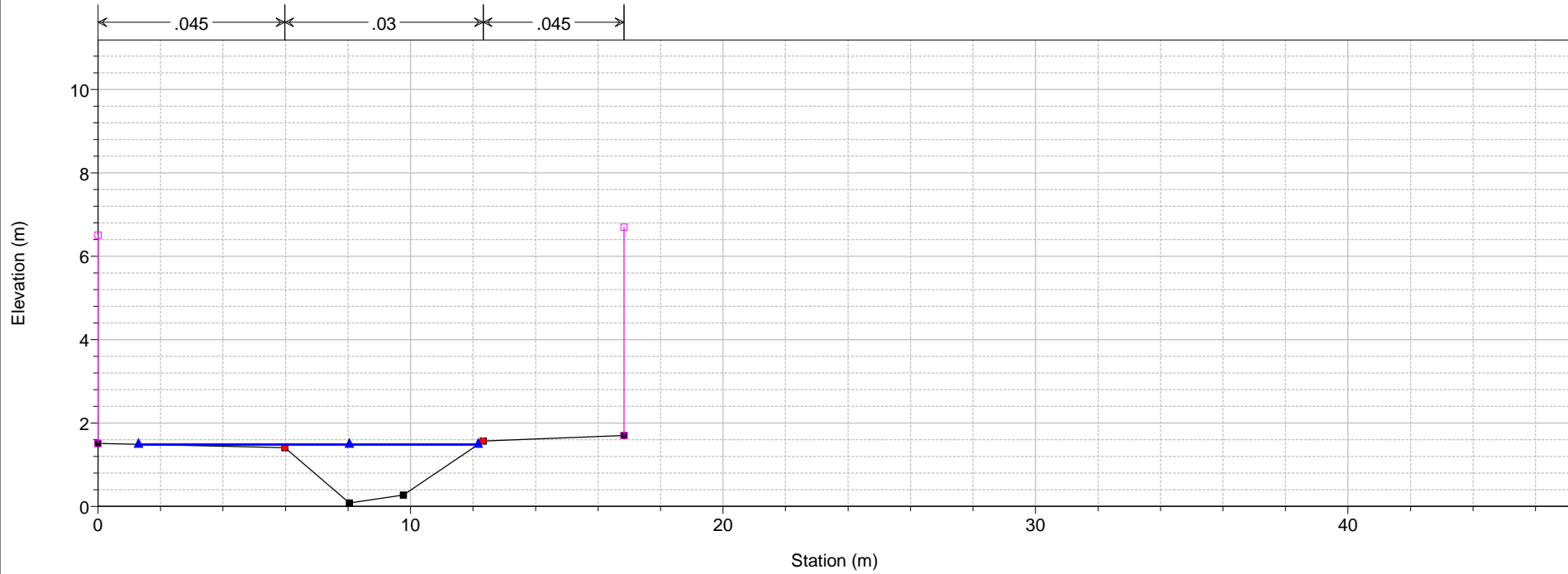

1) A TR 200 2) A TR 30
River = vallecorsa Reach = valle RS = 80

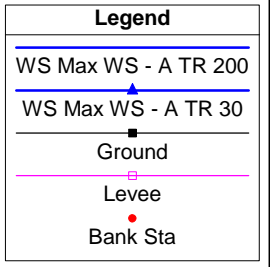
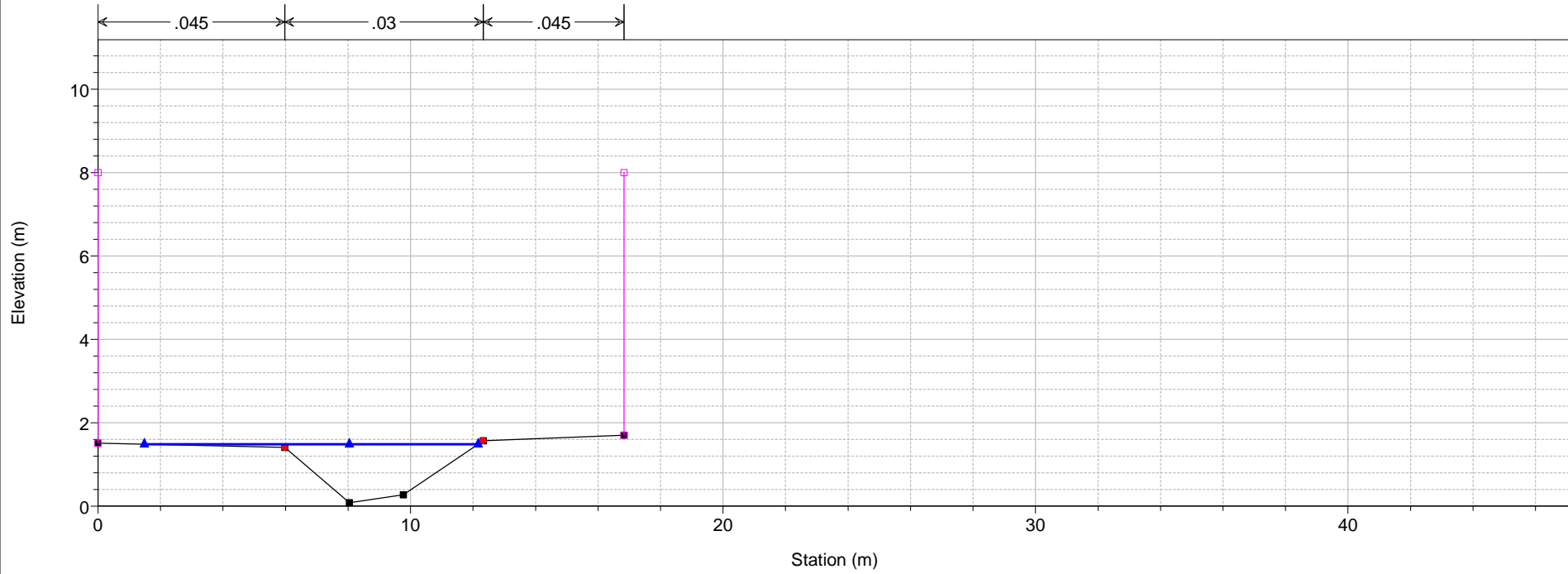

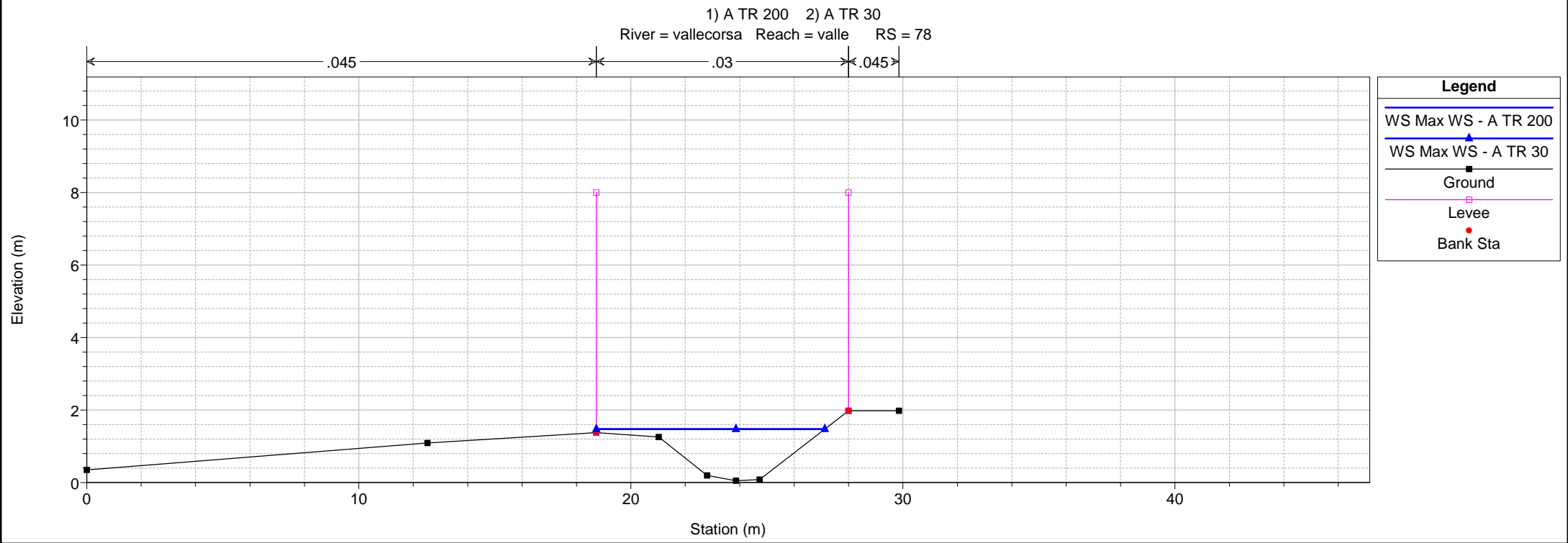
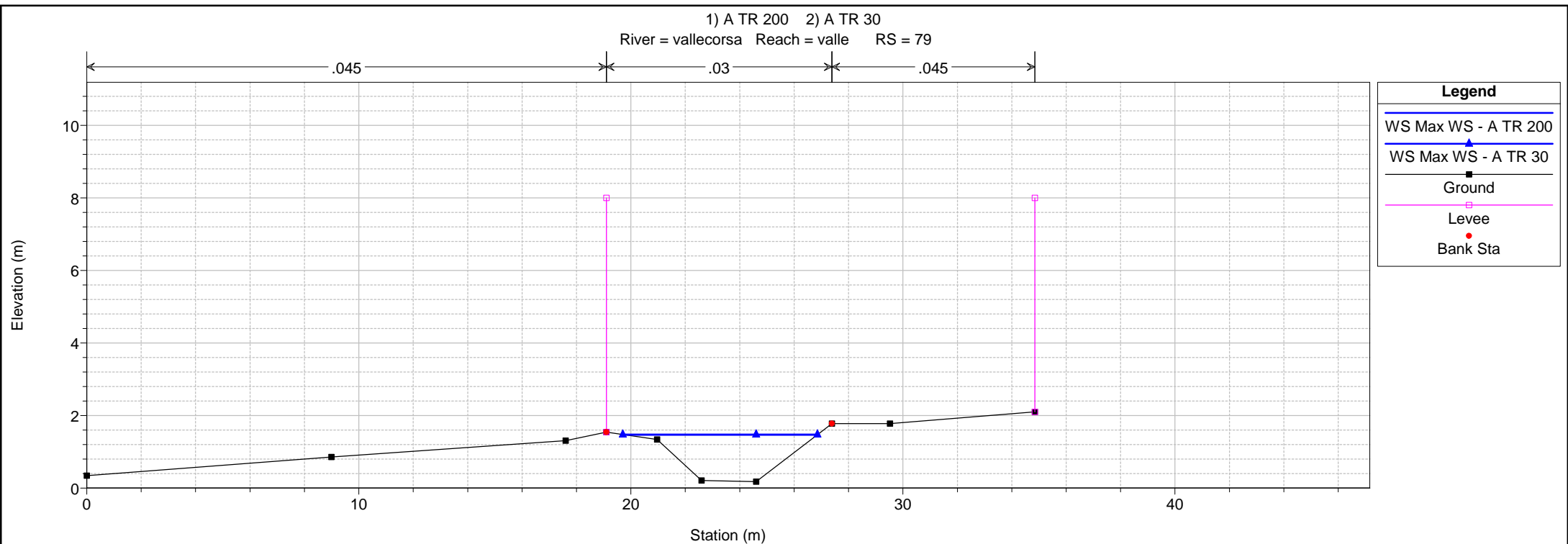

1 cm Horiz. = 2 m 1 cm Vert. = 1.5 m

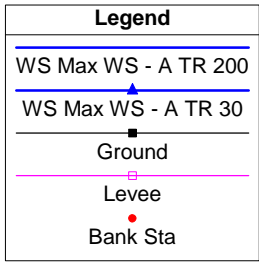
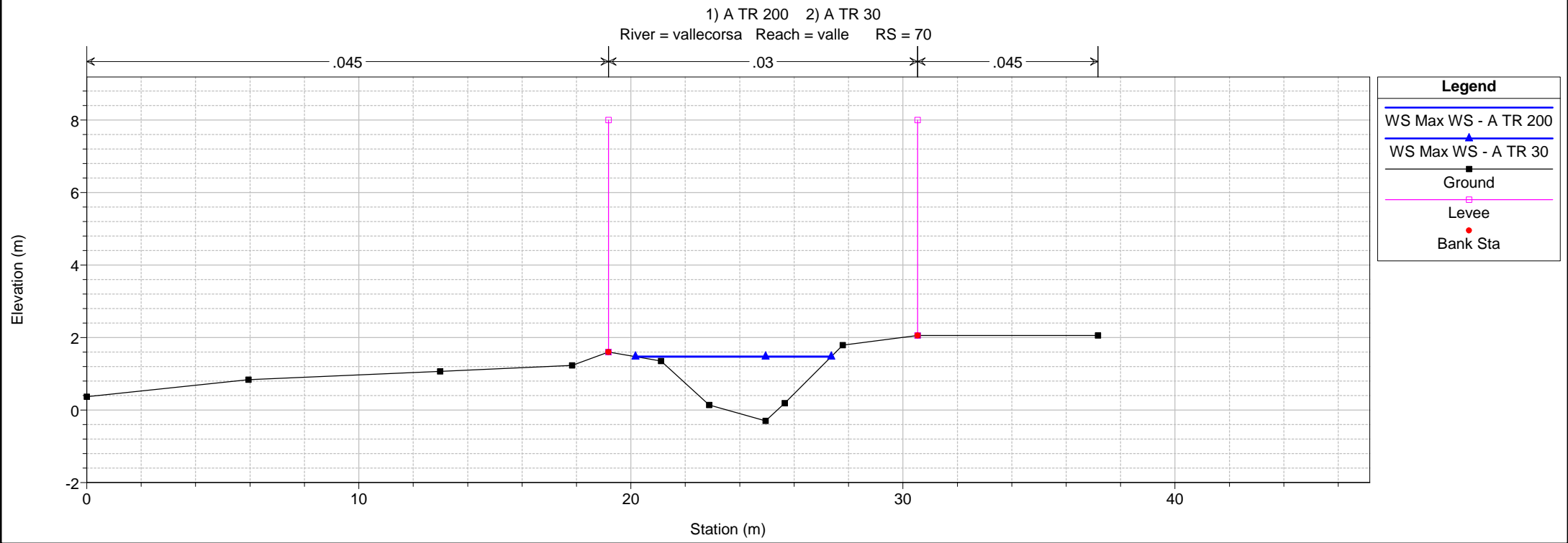
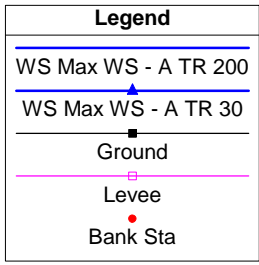
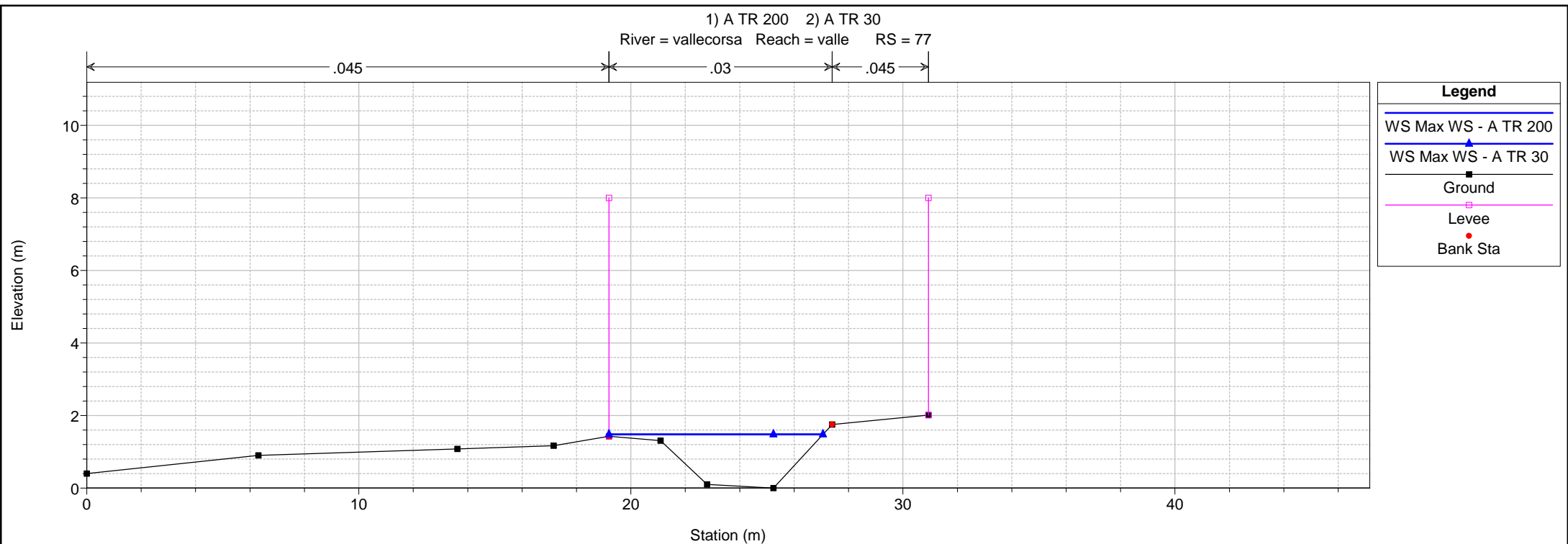

1 cm Horiz. = 2 m 1 cm Vert. = 1.5 m

1) A TR 200 2) A TR 30
River = vallecorsa Reach = valle RS = 60

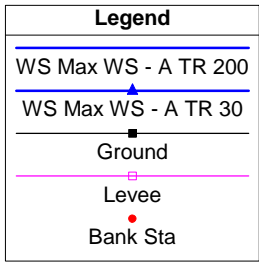
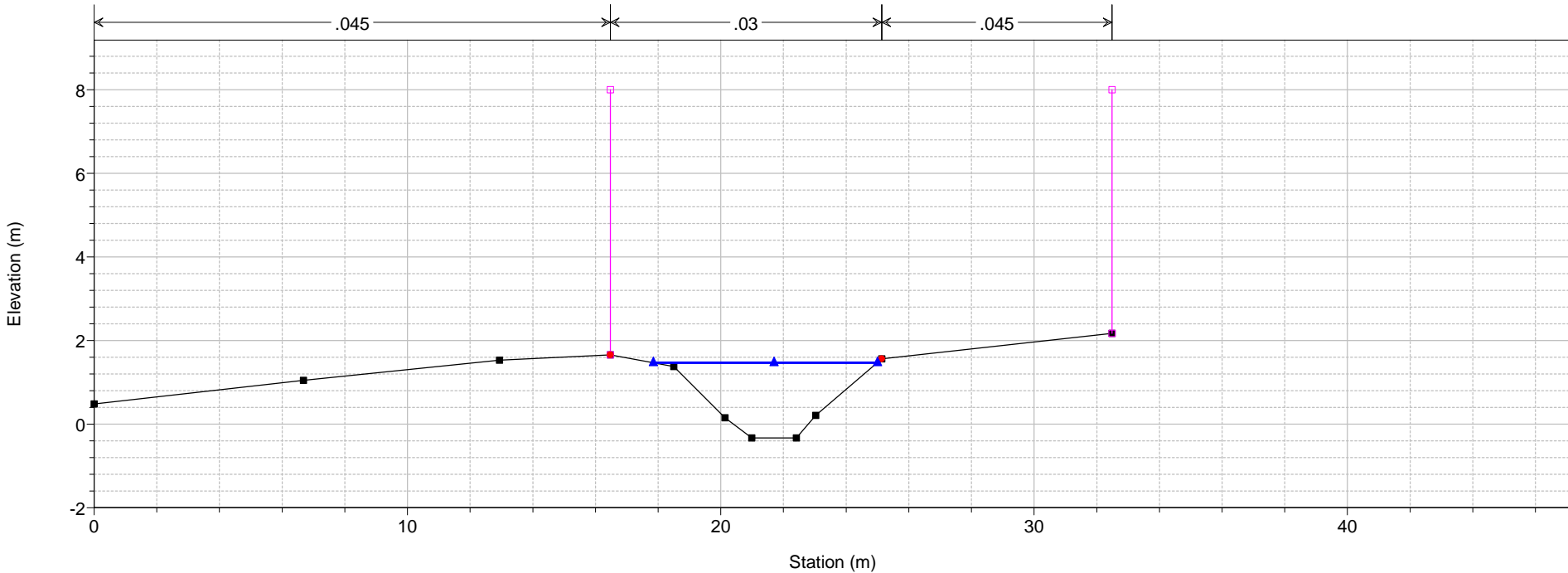

1) A TR 200 2) A TR 30
River = vallecorsa Reach = valle RS = 50

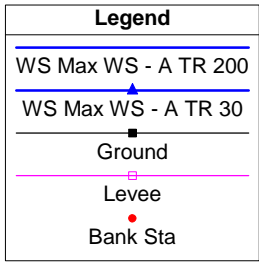
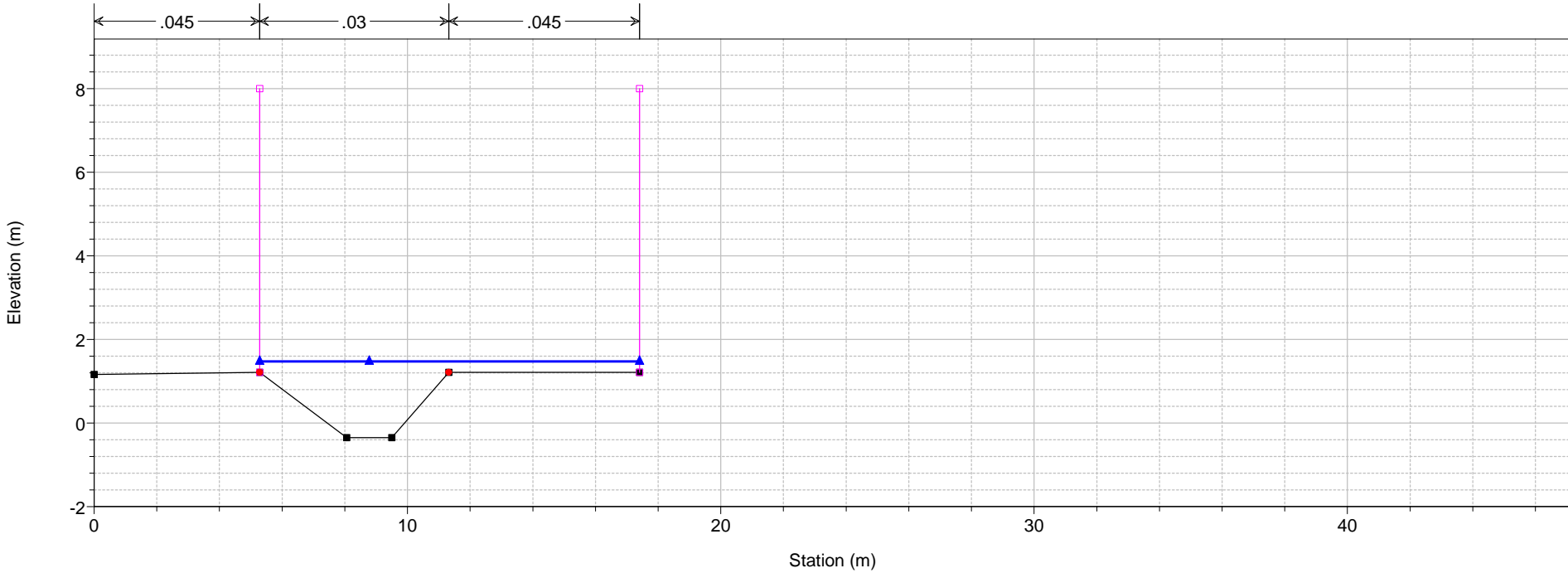

1) A TR 200 2) A TR 30
 River = vallecorsa Reach = valle RS = 45

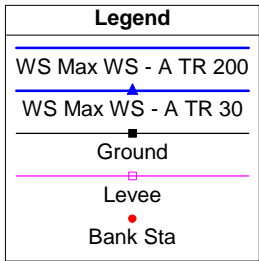
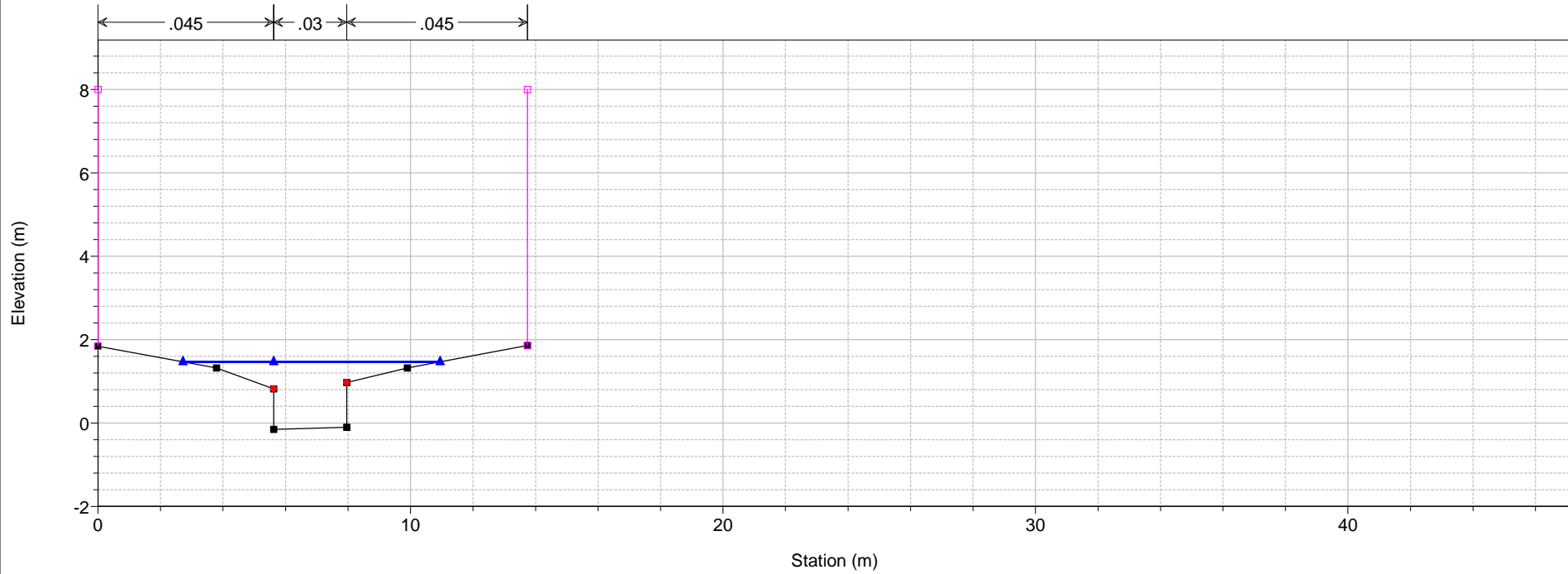

1) A TR 200 2) A TR 30
 River = vallecorsa Reach = valle RS = 42.5

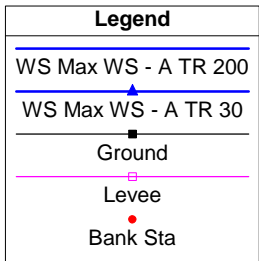
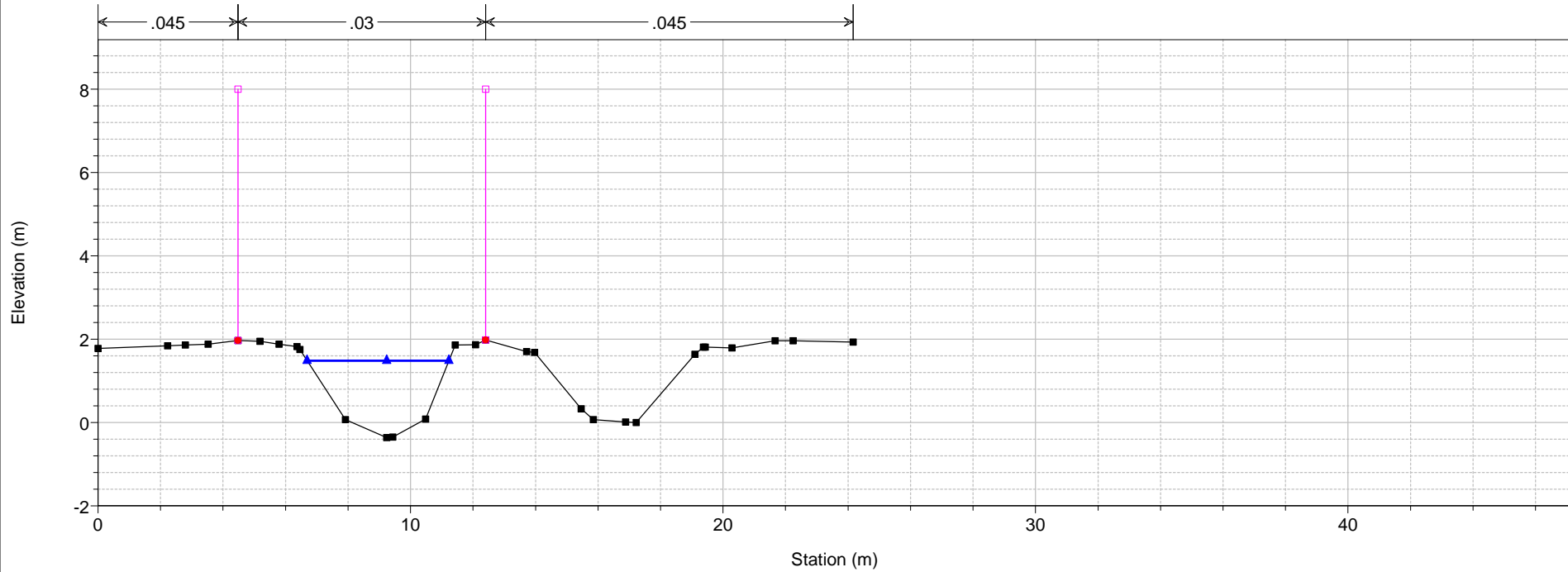

1 cm Horiz. = 2 m 1 cm Vert. = 1.5 m

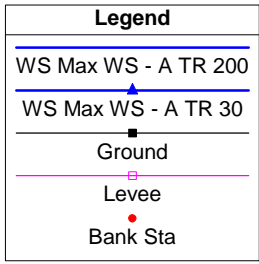
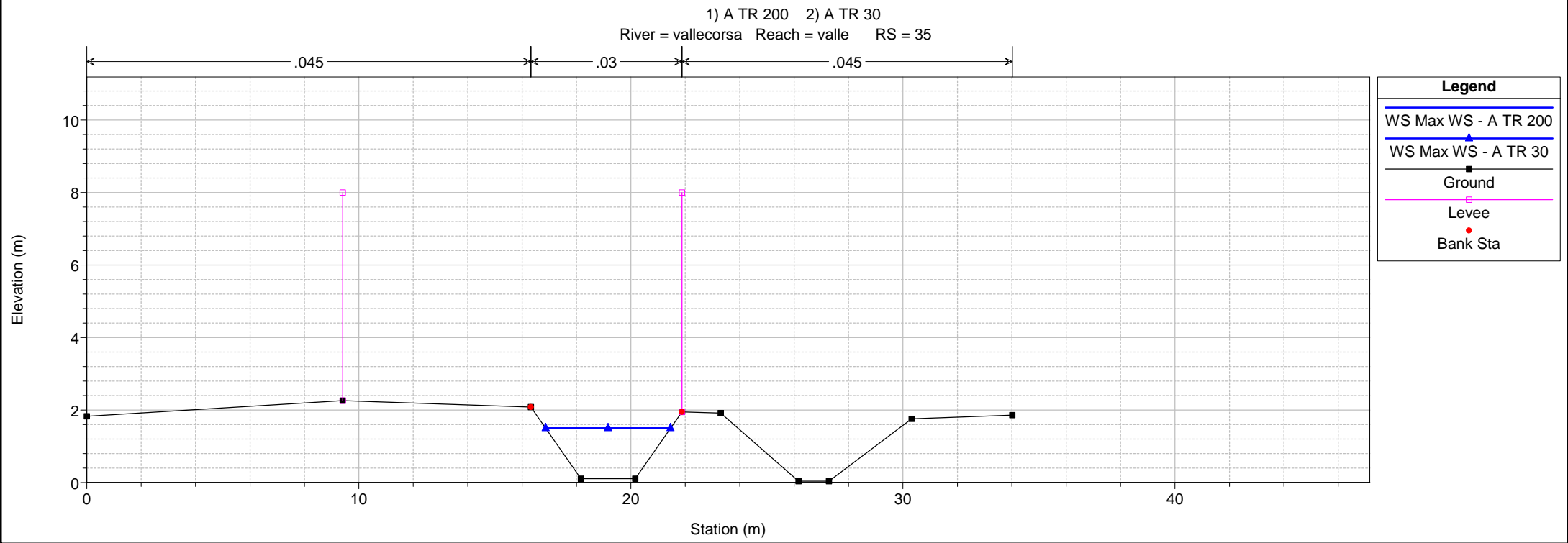
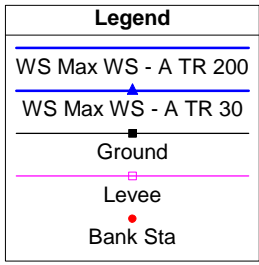
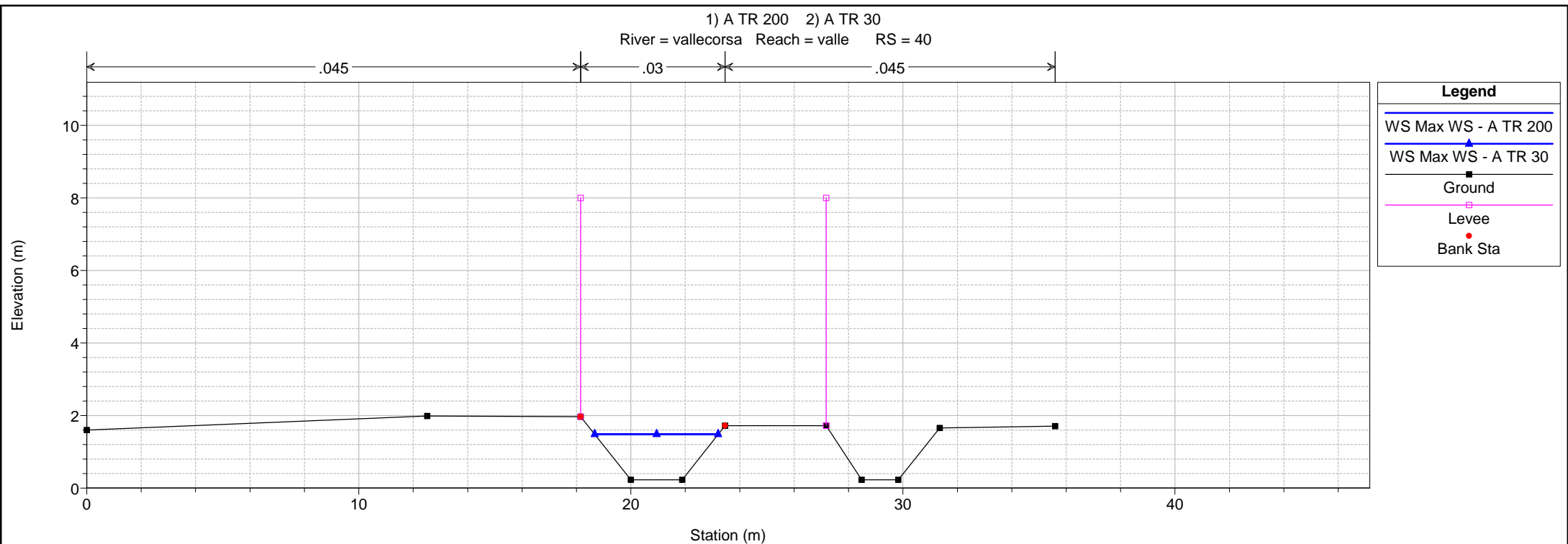

1 cm Horiz. = 2 m 1 cm Vert. = 1.5 m

1) A TR 200 2) A TR 30
 River = vallecorsa Reach = valle RS = 32

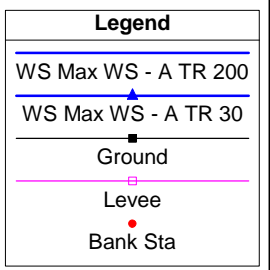
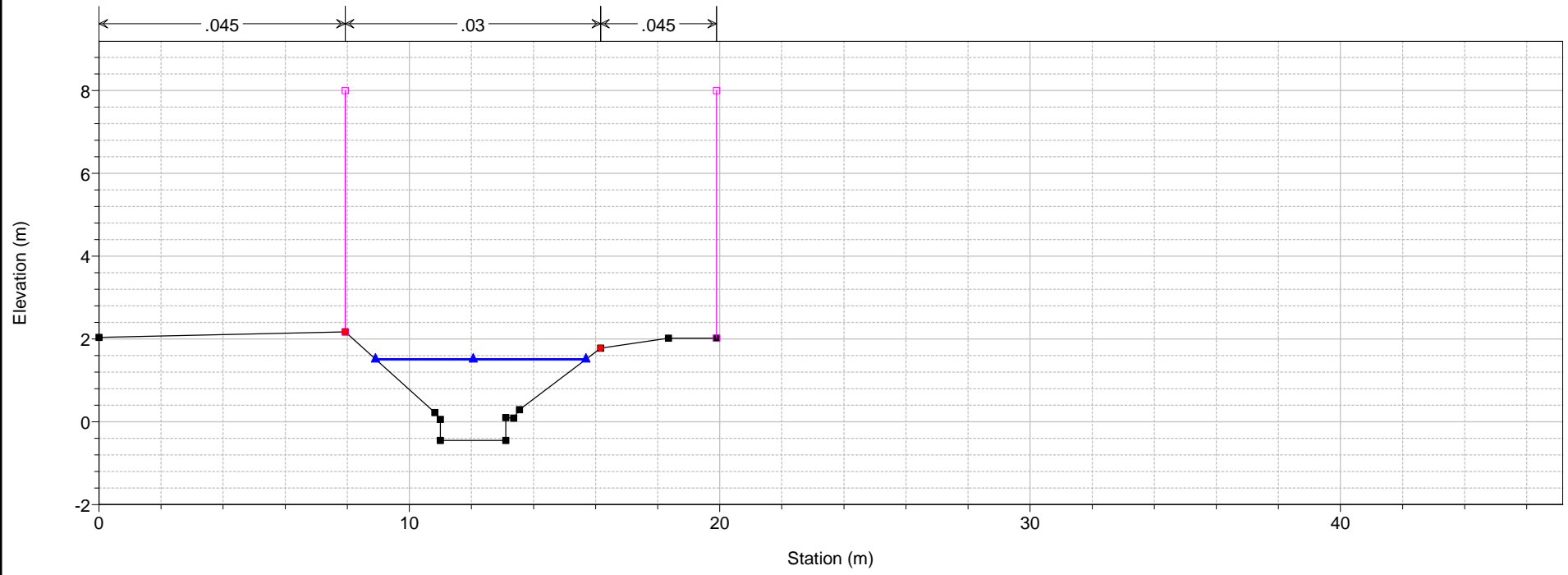

1) A TR 200 2) A TR 30
 River = vallecorsa Reach = valle RS = 30

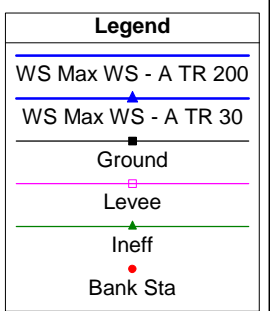
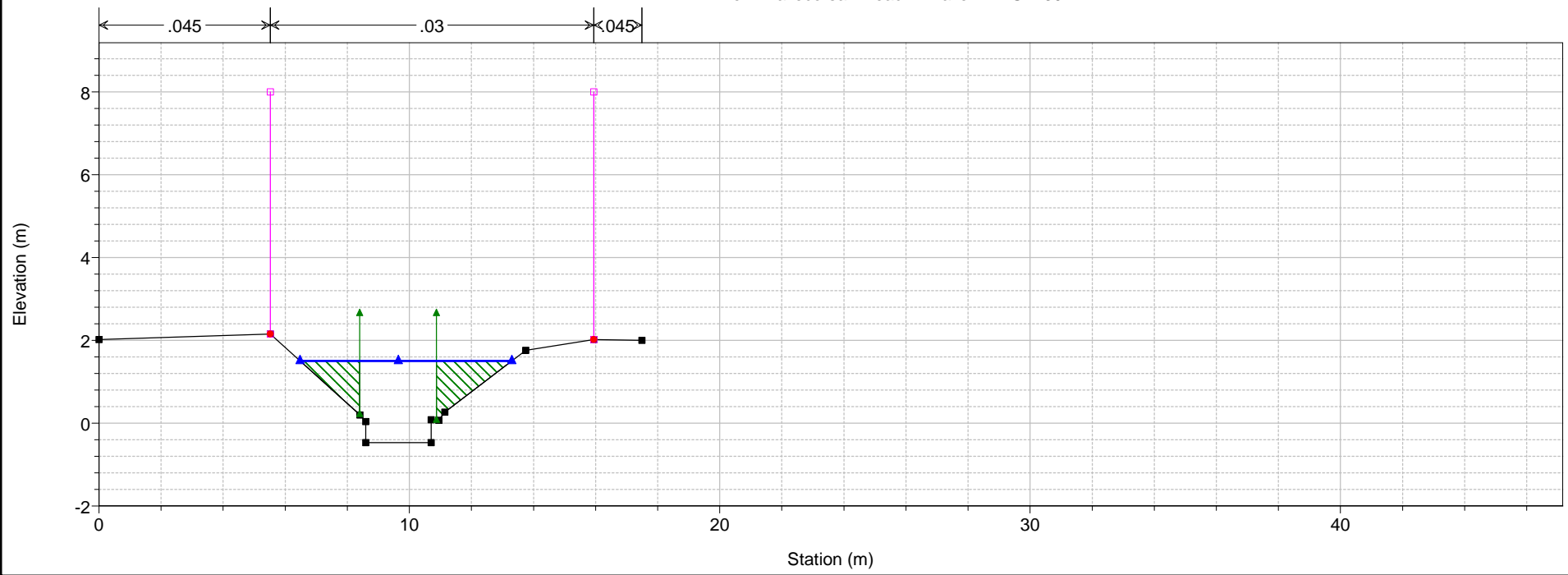

1 cm Horiz. = 2 m 1 cm Vert. = 1.5 m

1) A TR 200 2) A TR 30
 River = vallecorsa Reach = valle RS = 29.5 BR

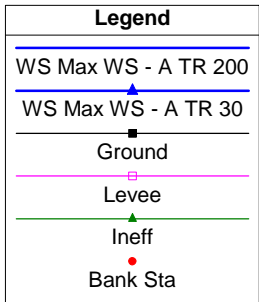
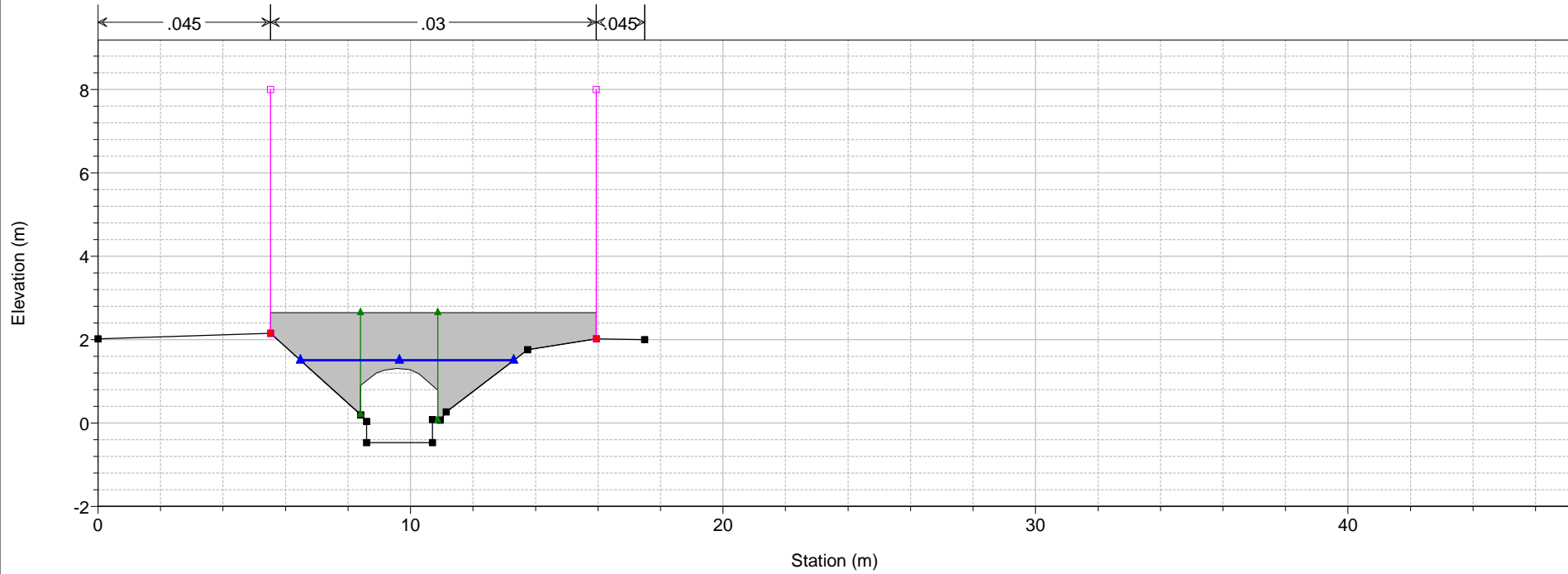

1) A TR 200 2) A TR 30
 River = vallecorsa Reach = valle RS = 29.5 BR

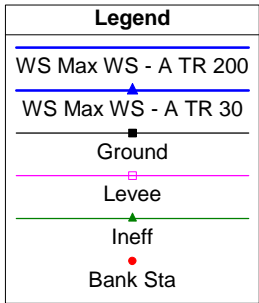
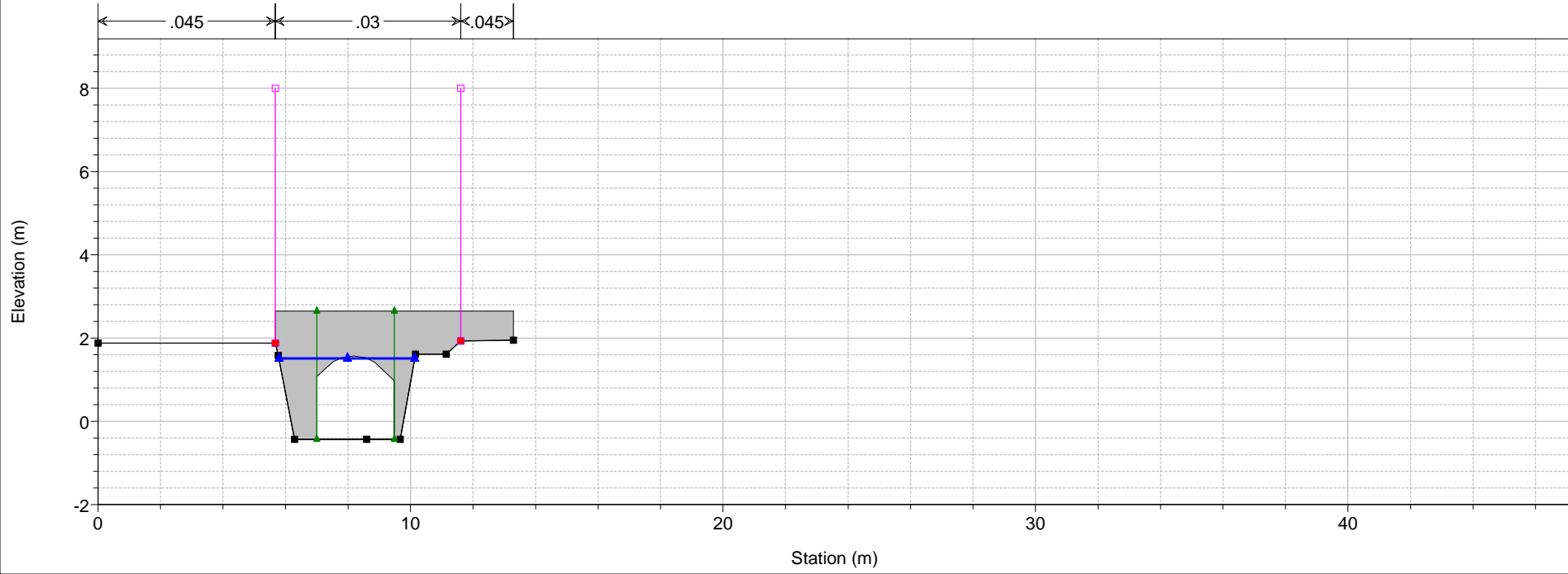

1) A TR 200 2) A TR 30
River = vallecorsa Reach = valle RS = 29

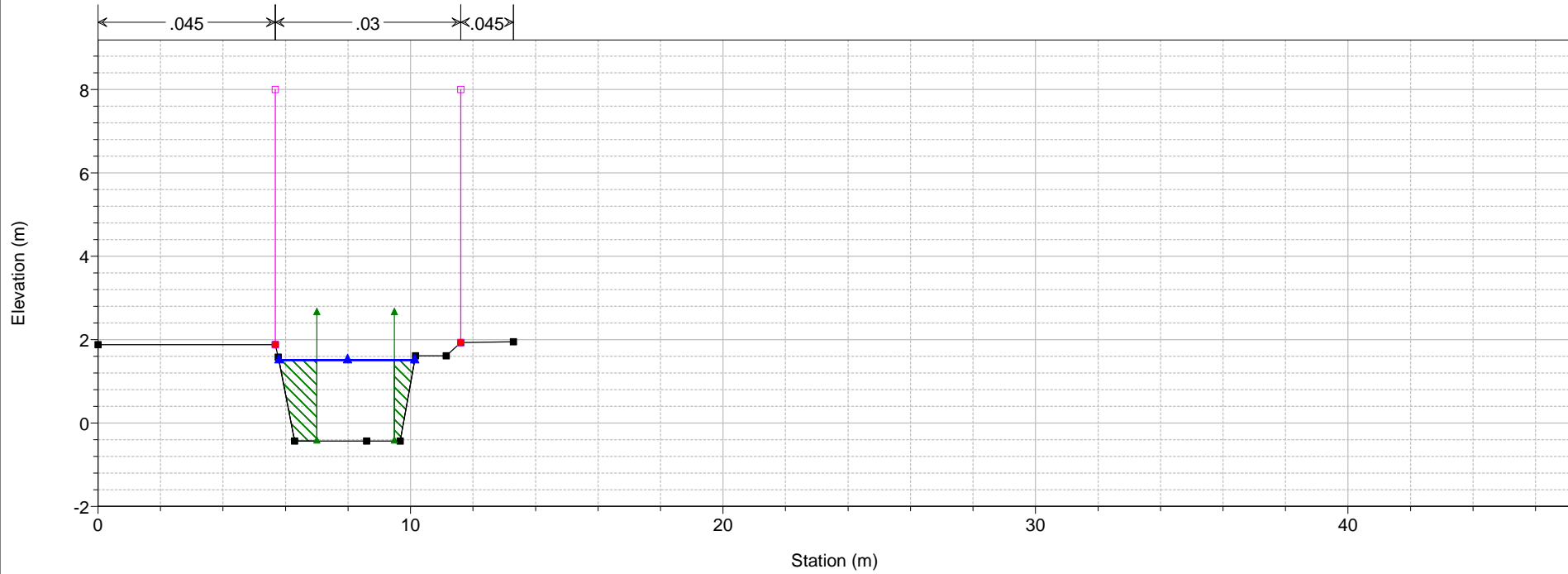

1) A TR 200 2) A TR 30
River = vallecorsa Reach = valle RS = 28

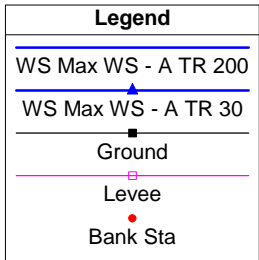
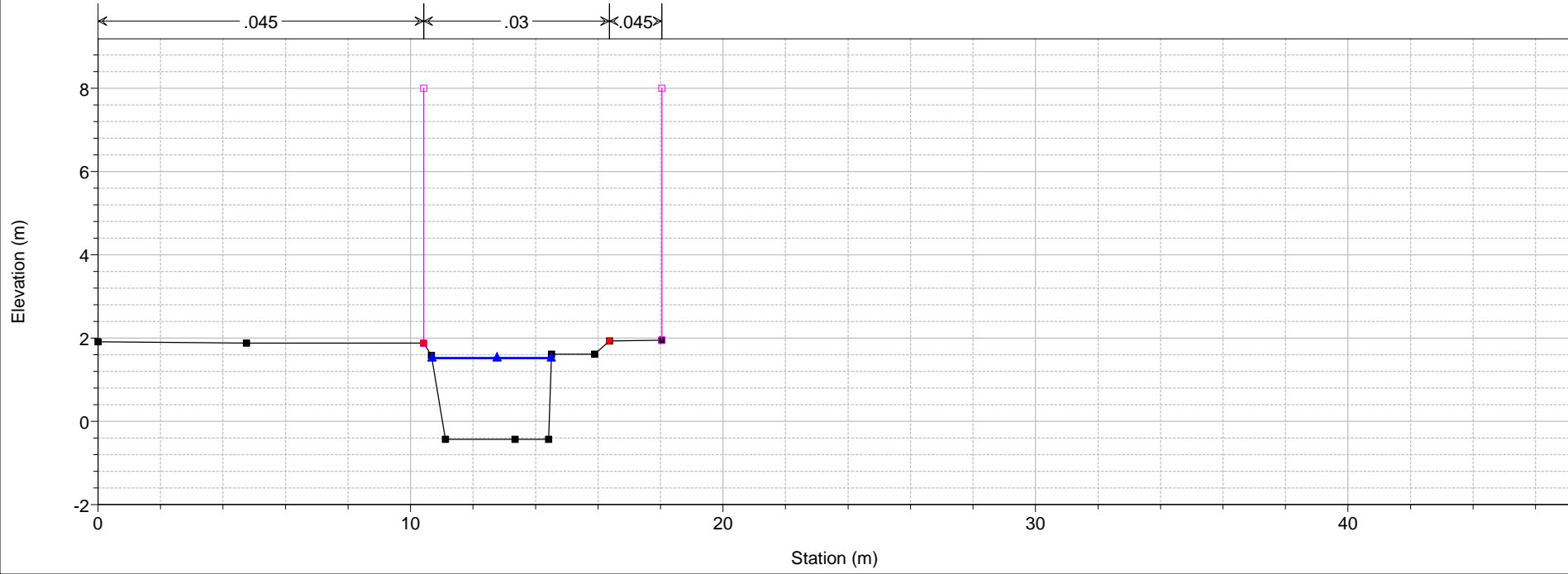

1 cm Horiz. = 2 m 1 cm Vert. = 1.5 m

1) A TR 200 2) A TR 30
 River = vallecorsa Reach = valle RS = 27

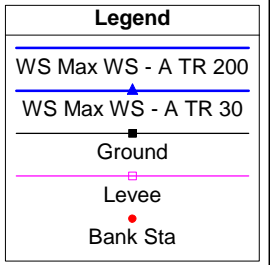
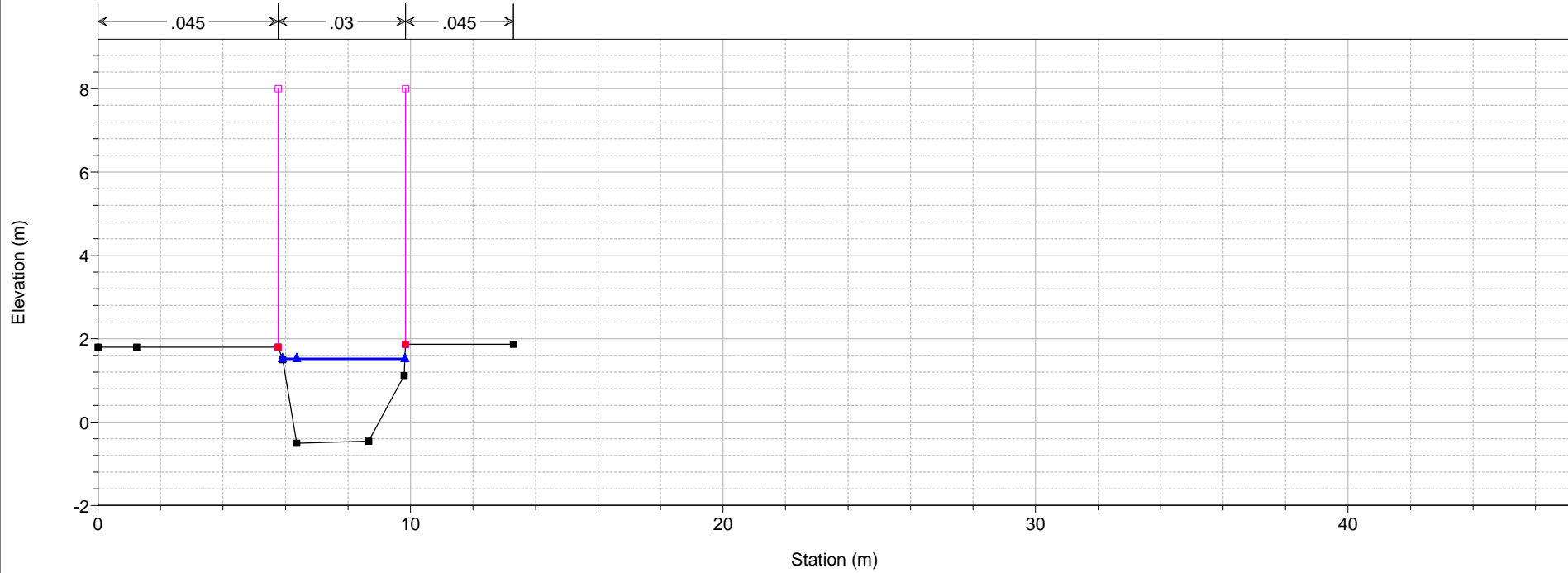

1) A TR 200 2) A TR 30
 River = vallecorsa Reach = valle RS = 26

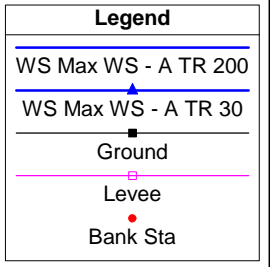
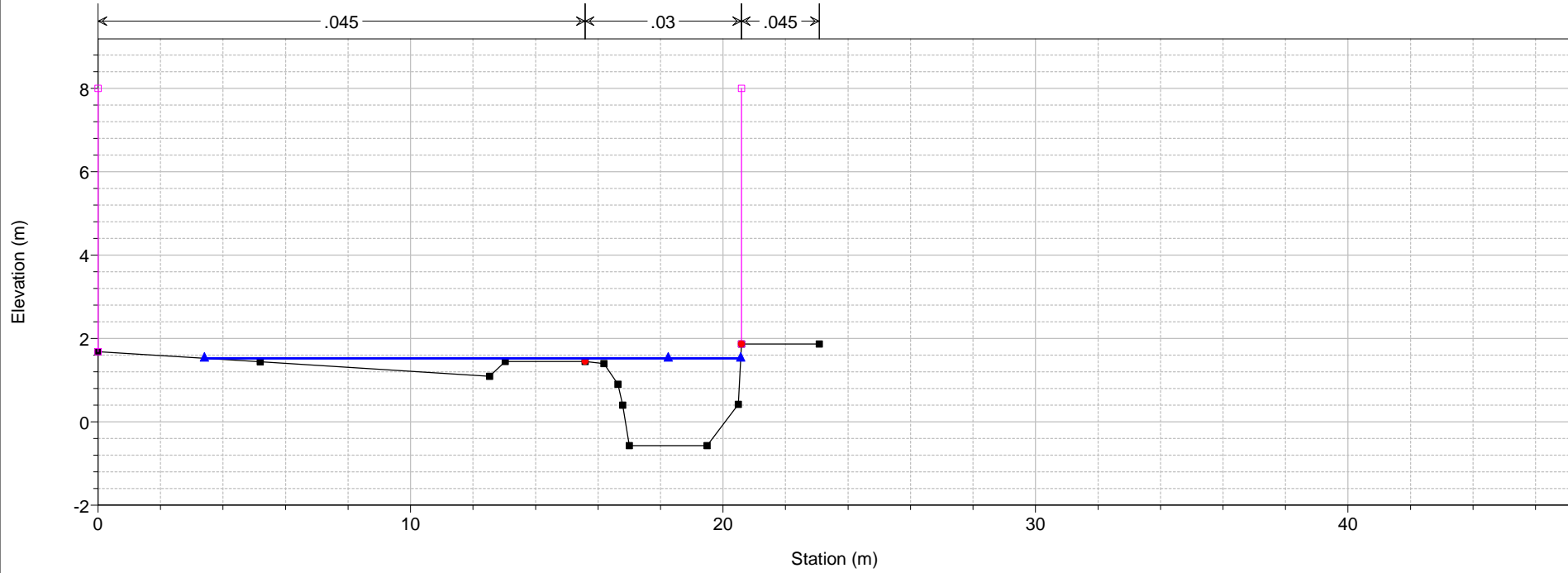

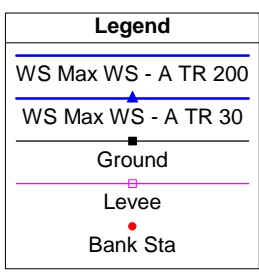
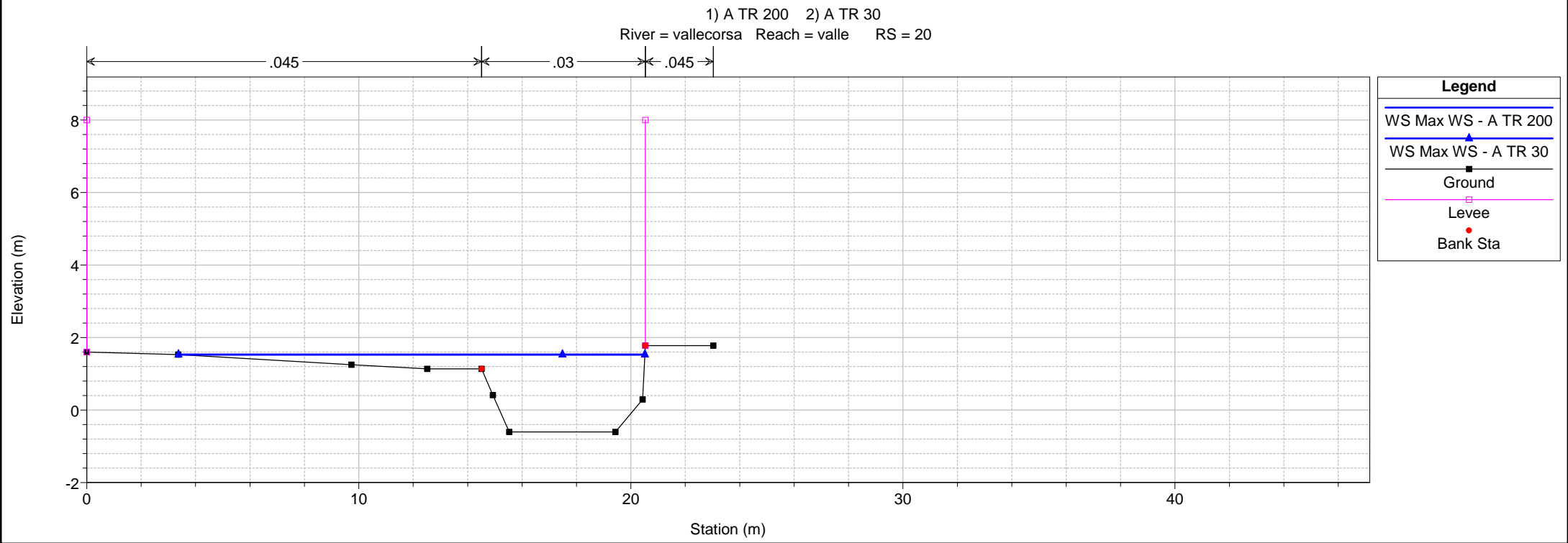
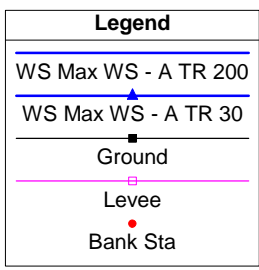
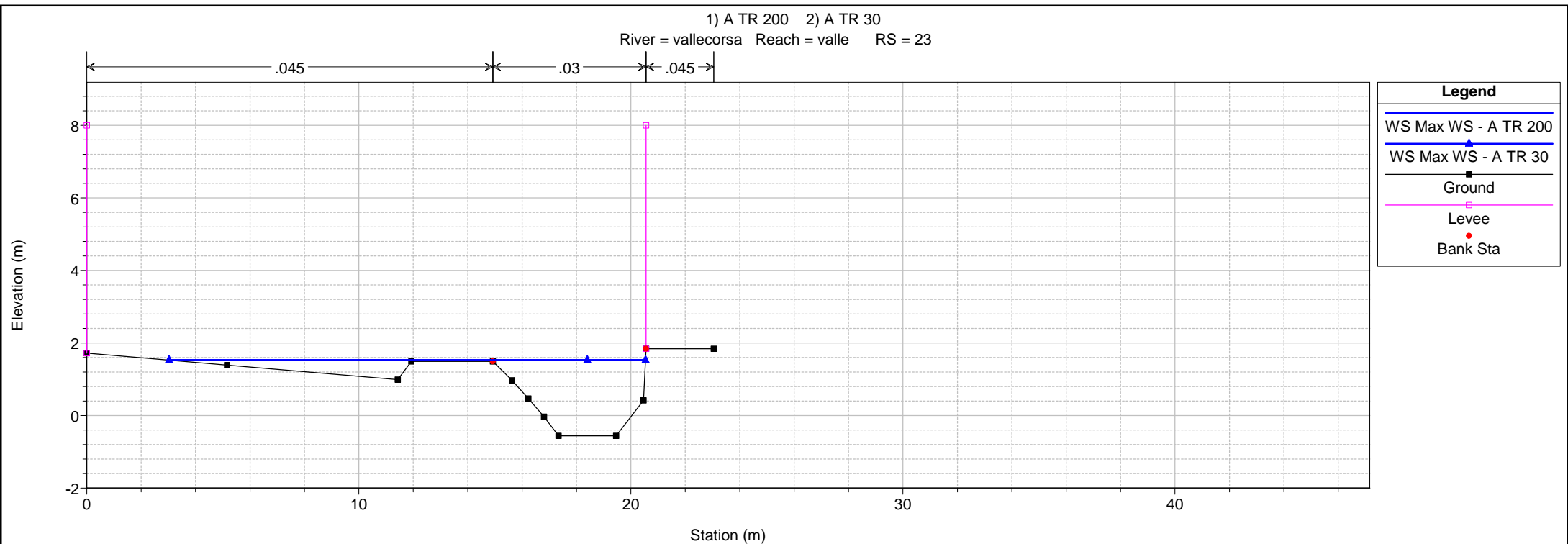

1 cm Horiz. = 2 m 1 cm Vert. = 1.5 m

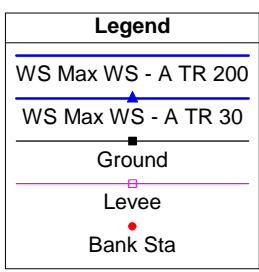
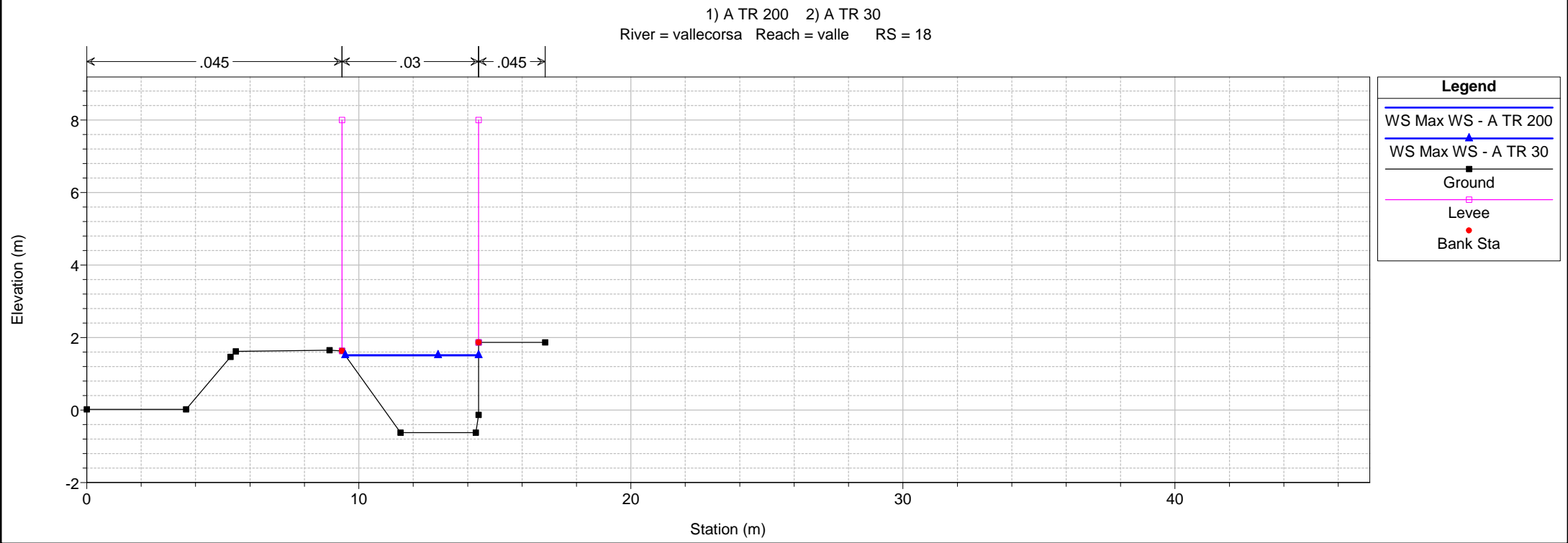
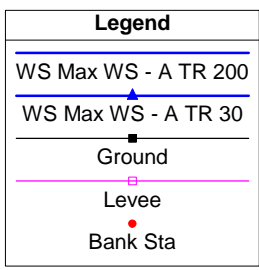
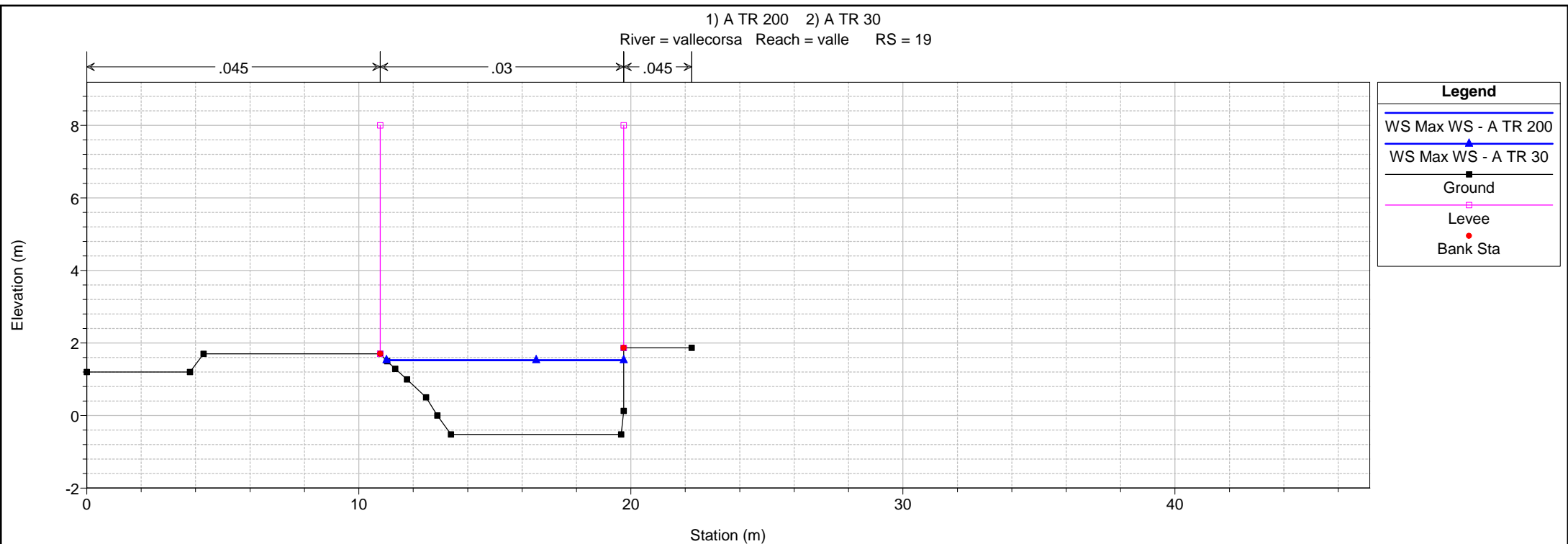

1 cm Horiz. = 2 m 1 cm Vert. = 1.5 m

1) A TR 200 2) A TR 30
River = vallecorsa Reach = valle RS = 13

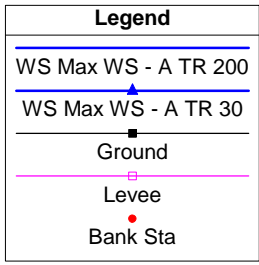
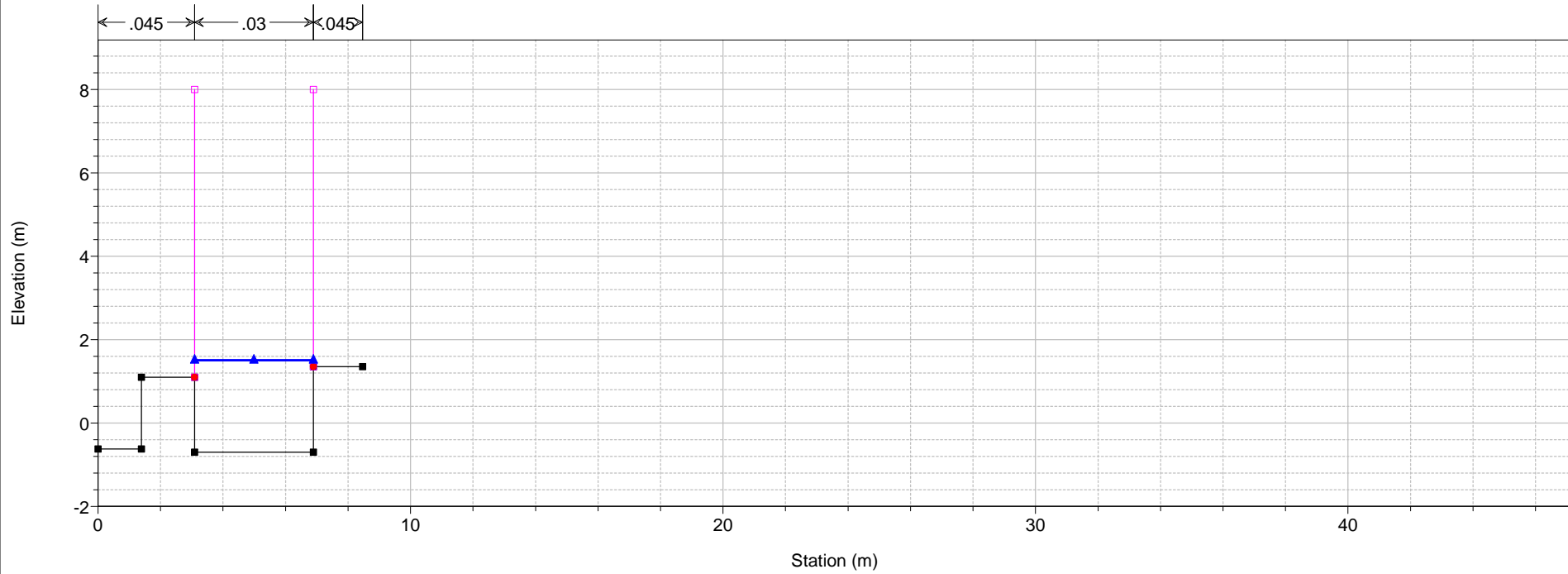

1) A TR 200 2) A TR 30
River = vallecorsa Reach = valle RS = 10

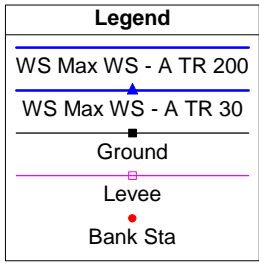
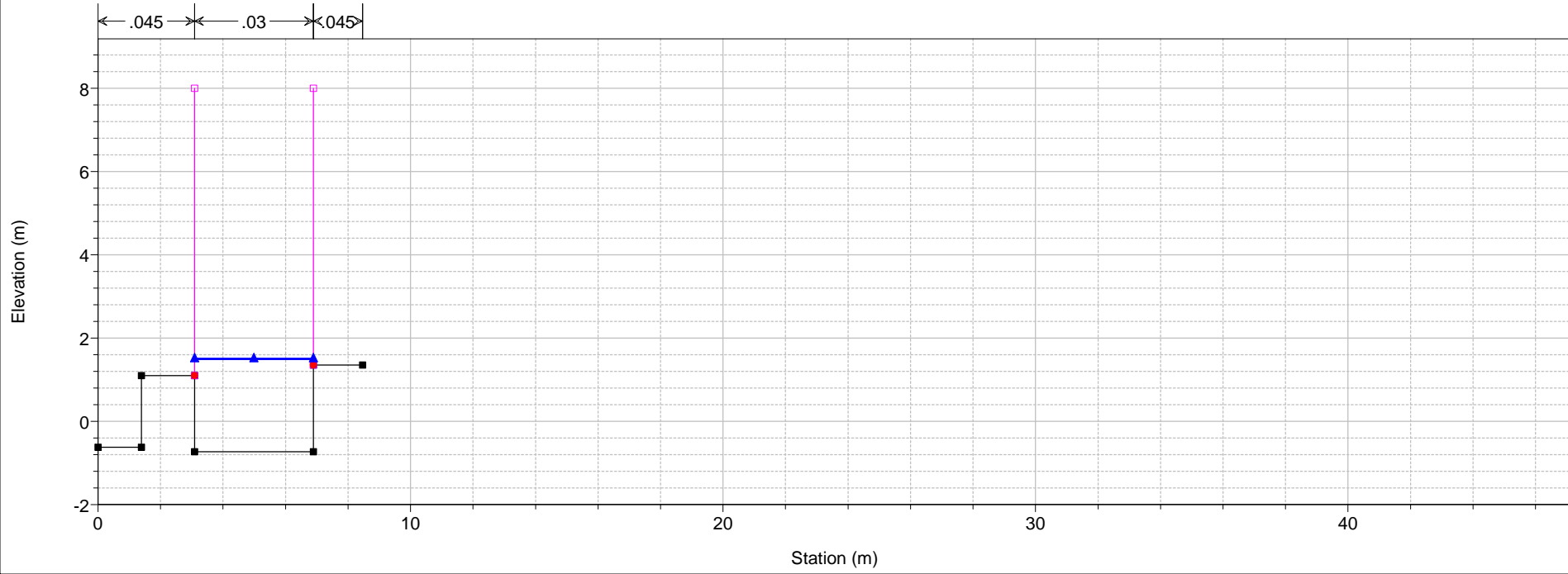

1 cm Horiz. = 2 m 1 cm Vert. = 1.5 m

Reach	River Sta	Profile	Plan	Q Total (m3/s)	Min Ch El (m)	W.S. Elev (m)	Crit W.S. (m)	E.G. Elev (m)	E.G. Slope (m/m)	Vel Chnl (m/s)	Flow Area (m2)	Top Width (m)	Froude # Chl
vallecorsa	114	Max WS	A TR 200	23.41	8.99	10.61	10.84	11.40	0.017746	4.20	7.18	11.50	1.30
vallecorsa	114	Max WS	A TR 30	12.43	8.99	10.41	10.52	10.85	0.012203	3.03	4.85	11.50	1.04
vallecorsa	113.99	Max WS	A TR 200	23.41	8.99	10.61	10.84	11.40	0.017876	4.21	7.16	11.50	1.30
vallecorsa	113.99	Max WS	A TR 30	12.43	8.99	10.41	10.52	10.85	0.012275	3.03	4.83	11.50	1.04
vallecorsa	113.98			Lat Struct									
vallecorsa	113.97			Lat Struct									
vallecorsa	113	Max WS	A TR 200	7.49	7.39	8.67	8.59	8.95	0.009153	2.35	3.29	7.38	0.86
vallecorsa	113	Max WS	A TR 30	7.37	7.39	8.66	8.58	8.94	0.009156	2.34	3.23	7.37	0.86
vallecorsa	112	Max WS	A TR 200	6.07	6.12	7.70	7.23	7.80	0.002495	1.39	4.38	4.56	0.45
vallecorsa	112	Max WS	A TR 30	6.04	6.12	7.70	7.23	7.80	0.002501	1.38	4.36	4.55	0.45
vallecorsa	111.5			Bridge									
vallecorsa	111	Max WS	A TR 200	6.07	6.23	7.42	7.27	7.62	0.006163	1.97	3.33	6.60	0.71
vallecorsa	111	Max WS	A TR 30	6.04	6.23	7.42	7.26	7.62	0.006154	1.97	3.32	6.57	0.71
vallecorsa	110.98			Lat Struct									
vallecorsa	110.97			Lat Struct									
vallecorsa	110	Max WS	A TR 200	3.50	5.61	6.62	6.56	6.74	0.005681	1.55	2.72	7.77	0.67
vallecorsa	110	Max WS	A TR 30	3.50	5.61	6.62	6.55	6.73	0.005680	1.55	2.72	7.77	0.67
vallecorsa	109	Max WS	A TR 200	2.85	5.08	6.21	5.78	6.27	0.002104	1.08	2.64	3.60	0.40
vallecorsa	109	Max WS	A TR 30	2.85	5.08	6.21	5.78	6.27	0.002106	1.08	2.64	3.59	0.40
vallecorsa	108.5			Bridge									
vallecorsa	108	Max WS	A TR 200	2.85	5.11	5.76	5.73	5.96	0.011433	1.97	1.45	3.09	0.92
vallecorsa	108	Max WS	A TR 30	2.85	5.11	5.76	5.73	5.96	0.011442	1.97	1.44	3.08	0.92
vallecorsa	107.98			Lat Struct									
vallecorsa	107.97			Lat Struct									
vallecorsa	107.5	Max WS	A TR 200	2.85	4.81	5.53	5.53	5.76	0.013838	2.12	1.35	2.94	1.00
vallecorsa	107.5	Max WS	A TR 30	2.85	4.81	5.53	5.53	5.76	0.013848	2.12	1.34	2.94	1.00
vallecorsa	106	Max WS	A TR 200	2.85	4.50	5.31	5.22	5.48	0.008862	1.84	1.55	2.81	0.79
vallecorsa	106	Max WS	A TR 30	2.85	4.50	5.31	5.22	5.48	0.008863	1.84	1.55	2.81	0.79
vallecorsa	105	Max WS	A TR 200	2.85	4.15	4.98	4.87	5.13	0.007574	1.70	1.68	3.24	0.75
vallecorsa	105	Max WS	A TR 30	2.85	4.15	4.98	4.87	5.13	0.007590	1.70	1.68	3.24	0.75
vallecorsa	104	Max WS	A TR 200	2.85	3.41	4.57	4.24	4.68	0.004337	1.44	1.99	2.62	0.53
vallecorsa	104	Max WS	A TR 30	2.85	3.41	4.57	4.24	4.67	0.004360	1.44	1.98	2.62	0.53
vallecorsa	103	Max WS	A TR 200	2.85	3.12	4.49	3.87	4.52	0.001053	0.82	3.47	4.28	0.29
vallecorsa	103	Max WS	A TR 30	2.85	3.12	4.48	3.87	4.52	0.001060	0.82	3.45	4.27	0.29
vallecorsa	102	Max WS	A TR 200	2.85	2.60	4.47	3.36	4.49	0.000258	0.50	6.02	11.41	0.15
vallecorsa	102	Max WS	A TR 30	2.85	2.60	4.47	3.36	4.48	0.000259	0.50	5.98	11.21	0.15
vallecorsa	101.2	Max WS	A TR 200	2.85	2.19	4.45	2.74	4.47	0.000205	0.57	5.00	9.62	0.12
vallecorsa	101.2	Max WS	A TR 30	2.85	2.19	4.45	2.74	4.47	0.000206	0.57	5.00	9.44	0.12
valle	101	Max WS	A TR 200	7.10	2.18	4.45	2.94	4.50	0.000595	0.91	8.49	11.34	0.19
valle	101	Max WS	A TR 30	7.08	2.18	4.45	2.94	4.49	0.000596	0.91	8.45	11.34	0.19
valle	100.7	Max WS	A TR 200	7.10	2.18	4.45	2.94	4.50	0.000595	0.91	8.49	11.34	0.19
valle	100.7	Max WS	A TR 30	7.08	2.18	4.45	2.94	4.49	0.000596	0.91	8.45	11.34	0.19
valle	100.5			Bridge									
valle	100	Max WS	A TR 200	7.10	1.97	4.05	3.16	4.23	0.004970	1.85	3.84	6.13	0.43
valle	100	Max WS	A TR 30	7.08	1.97	4.05	3.16	4.22	0.004966	1.85	3.83	6.08	0.43
valle	99.98			Lat Struct									
valle	99.97			Lat Struct									
valle	99	Max WS	A TR 200	7.10	1.93	3.69	3.25	4.05	0.017050	2.64	2.69	2.31	0.78
valle	99	Max WS	A TR 30	7.08	1.93	3.69	3.24	4.05	0.017003	2.64	2.68	2.28	0.78
valle	98	Max WS	A TR 200	7.10	1.80	3.09	2.80	3.26	0.004505	1.79	3.97	4.62	0.61
valle	98	Max WS	A TR 30	7.08	1.80	3.09	2.80	3.25	0.004502	1.78	3.97	4.62	0.61
valle	97	Max WS	A TR 200	7.10	1.16	2.78	2.30	2.90	0.002984	1.56	4.56	4.55	0.50
valle	97	Max WS	A TR 30	7.08	1.16	2.77	2.30	2.90	0.002980	1.55	4.55	4.54	0.50

HEC-RAS Profile: Max WS (Continued)

Reach	River Sta	Profile	Plan	Q Total (m3/s)	Min Ch El (m)	W.S. Elev (m)	Crit W.S. (m)	E.G. Elev (m)	E.G. Slope (m/m)	Vel Chnl (m/s)	Flow Area (m2)	Top Width (m)	Froude # Chl
valle	96	Max WS	A TR 200	7.10	0.83	2.46	2.07	2.61	0.004013	1.74	4.07	4.19	0.56
valle	96	Max WS	A TR 30	7.08	0.83	2.46	2.07	2.61	0.004001	1.74	4.07	4.18	0.56
valle	95	Max WS	A TR 200	7.10	0.92	2.46	2.00	2.52	0.001788	1.04	6.80	9.71	0.40
valle	95	Max WS	A TR 30	7.08	0.92	2.46	1.99	2.52	0.001782	1.04	6.79	9.71	0.40
valle	94	Max WS	A TR 200	6.92	0.90	2.37	1.87	2.49	0.002892	1.56	4.44	4.13	0.48
valle	94	Max WS	A TR 30	6.90	0.90	2.37	1.87	2.49	0.002885	1.56	4.44	4.13	0.48
valle	93	Max WS	A TR 200	6.64	0.95	2.21	1.98	2.40	0.005721	1.94	3.61	16.37	0.68
valle	93	Max WS	A TR 30	6.63	0.95	2.21	1.98	2.40	0.005715	1.94	3.60	16.37	0.68
valle	92	Max WS	A TR 200	6.41	0.60	1.89	1.58	2.03	0.003784	1.65	4.73	14.54	0.56
valle	92	Max WS	A TR 30	6.41	0.60	1.89	1.58	2.03	0.003780	1.65	4.73	14.54	0.56
valle	91	Max WS	A TR 200	4.15	0.55	1.78	1.34	1.85	0.001947	1.24	3.66	5.16	0.41
valle	91	Max WS	A TR 30	4.15	0.55	1.78	1.33	1.85	0.001946	1.24	3.66	5.16	0.41
valle	90	Max WS	A TR 200	3.65	0.28	1.76	0.90	1.80	0.001252	0.94	3.90	2.96	0.26
valle	90	Max WS	A TR 30	3.65	0.28	1.76	0.90	1.80	0.001252	0.94	3.90	2.96	0.26
valle	89.5			Bridge									
valle	89	Max WS	A TR 200	3.65	0.33	1.58	1.06	1.67	0.001470	1.38	2.65	5.77	0.41
valle	89	Max WS	A TR 30	3.64	0.33	1.58	1.05	1.67	0.001464	1.37	2.65	5.77	0.41
valle	88	Max WS	A TR 200	3.65	0.27	1.60	1.00	1.64	0.001057	0.87	4.20	5.00	0.30
valle	88	Max WS	A TR 30	3.64	0.27	1.60	1.00	1.64	0.001055	0.87	4.19	4.99	0.30
valle	87	Max WS	A TR 200	3.65	0.18	1.58	0.94	1.61	0.000970	0.84	4.32	5.04	0.29
valle	87	Max WS	A TR 30	3.64	0.18	1.58	0.94	1.61	0.000967	0.84	4.31	5.03	0.29
valle	86	Max WS	A TR 200	3.65	0.55	1.54	1.17	1.60	0.002133	1.10	3.31	4.88	0.43
valle	86	Max WS	A TR 30	3.64	0.55	1.54	1.17	1.60	0.002125	1.10	3.31	4.87	0.43
valle	85	Max WS	A TR 200	3.65	0.31	1.53	1.04	1.57	0.001371	0.93	3.93	5.38	0.35
valle	85	Max WS	A TR 30	3.63	0.31	1.53	1.04	1.57	0.001363	0.93	3.92	5.38	0.35
valle	84	Max WS	A TR 200	3.65	0.26	1.51	0.88	1.53	0.000793	0.76	4.81	5.94	0.27
valle	84	Max WS	A TR 30	3.63	0.26	1.50	0.88	1.53	0.000788	0.76	4.81	5.94	0.27
valle	83.97			Lat Struct									
valle	83	Max WS	A TR 200	3.65	0.08	1.49	0.79	1.51	0.000612	0.69	5.45	10.89	0.24
valle	83	Max WS	A TR 30	3.63	0.08	1.49	0.79	1.51	0.000608	0.69	5.45	10.87	0.24
valle	80	Max WS	A TR 200	3.65	0.08	1.49	0.79	1.51	0.000619	0.69	5.42	10.72	0.24
valle	80	Max WS	A TR 30	3.63	0.08	1.49	0.79	1.51	0.000614	0.69	5.42	10.69	0.24
valle	79	Max WS	A TR 200	3.65	0.18	1.48	0.79	1.50	0.000740	0.69	5.26	7.16	0.26
valle	79	Max WS	A TR 30	3.63	0.18	1.48	0.78	1.50	0.000734	0.69	5.26	7.16	0.26
valle	78	Max WS	A TR 200	3.32	0.05	1.47	0.68	1.49	0.000486	0.55	6.00	8.40	0.21
valle	78	Max WS	A TR 30	3.31	0.05	1.47	0.68	1.49	0.000482	0.55	6.00	8.40	0.21
valle	77	Max WS	A TR 200	2.59	0.00	1.48	0.50	1.49	0.000231	0.41	6.36	7.87	0.14
valle	77	Max WS	A TR 30	2.58	0.00	1.48	0.49	1.49	0.000231	0.41	6.35	7.87	0.14
valle	70	Max WS	A TR 200	2.52	-0.30	1.47	0.37	1.48	0.000165	0.37	6.73	7.20	0.12
valle	70	Max WS	A TR 30	2.52	-0.30	1.47	0.37	1.48	0.000164	0.37	6.73	7.20	0.12
valle	60	Max WS	A TR 200	2.52	-0.33	1.47	0.23	1.48	0.000129	0.35	7.27	7.15	0.11
valle	60	Max WS	A TR 30	2.52	-0.33	1.47	0.23	1.48	0.000128	0.35	7.27	7.15	0.11
valle	59.68			Lat Struct									
valle	59.67			Lat Struct									
valle	50	Max WS	A TR 200	-1.69	-0.35	1.47	0.09	1.48	0.000041	-0.22	9.05	12.13	0.06
valle	50	Max WS	A TR 30	-1.67	-0.35	1.47	0.09	1.48	0.000040	-0.21	9.04	12.13	0.06
valle	45	Max WS	A TR 200	-2.36	-0.15	1.47	0.34	1.48	0.000358	-0.57	5.23	8.23	0.14
valle	45	Max WS	A TR 30	-2.33	-0.15	1.47	0.34	1.48	0.000349	-0.56	5.23	8.22	0.14
valle	42.5	Max WS	A TR 200	-2.36	-0.36	1.48	0.29	1.49	0.000183	-0.42	5.59	4.54	0.12
valle	42.5	Max WS	A TR 30	-2.33	-0.36	1.48	0.29	1.49	0.000179	-0.42	5.59	4.54	0.12
valle	40	Max WS	A TR 200	-2.36	0.23	1.48	0.72	1.50	0.000471	-0.59	4.03	4.54	0.20
valle	40	Max WS	A TR 30	-2.33	0.23	1.48	0.72	1.50	0.000460	-0.58	4.03	4.54	0.20
valle	35	Max WS	A TR 200	-2.36	0.11	1.50	0.59	1.51	0.000327	-0.51	4.58	4.60	0.16
valle	35	Max WS	A TR 30	-2.33	0.11	1.50	0.59	1.51	0.000319	-0.51	4.58	4.60	0.16

HEC-RAS Profile: Max WS (Continued)

Reach	River Sta	Profile	Plan	Q Total (m3/s)	Min Ch El (m)	W.S. Elev (m)	Crit W.S. (m)	E.G. Elev (m)	E.G. Slope (m/m)	Vel Chnl (m/s)	Flow Area (m2)	Top Width (m)	Froude # Chl
valle	32	Max WS	A TR 200	-2.36	-0.45	1.51	0.05	1.52	0.000107	-0.31	7.53	6.78	0.09
valle	32	Max WS	A TR 30	-2.33	-0.45	1.51	0.05	1.52	0.000105	-0.31	7.53	6.78	0.09
valle	30	Max WS	A TR 200	-2.36	-0.47	1.50		1.52	0.000162	-0.51	4.67	6.83	0.12
valle	30	Max WS	A TR 30	-2.33	-0.47	1.50		1.52	0.000158	-0.50	4.67	6.82	0.12
valle	29.5			Bridge									
valle	29	Max WS	A TR 200	-2.36	-0.43	1.51	0.02	1.53	0.000089	-0.49	4.82	4.35	0.11
valle	29	Max WS	A TR 30	-2.33	-0.43	1.51	0.02	1.52	0.000087	-0.48	4.82	4.35	0.11
valle	28	Max WS	A TR 200	-2.36	-0.43	1.52	-0.06	1.53	0.000110	-0.34	6.94	3.82	0.08
valle	28	Max WS	A TR 30	-2.33	-0.43	1.52	-0.06	1.52	0.000107	-0.34	6.94	3.82	0.08
valle	27	Max WS	A TR 200	-2.36	-0.51	1.52	-0.02	1.53	0.000129	-0.37	6.43	3.92	0.09
valle	27	Max WS	A TR 30	-2.33	-0.51	1.52	-0.03	1.52	0.000126	-0.36	6.43	3.92	0.09
valle	26	Max WS	A TR 200	-2.36	-0.57	1.52	-0.13	1.53	0.000080	-0.29	9.85	17.19	0.08
valle	26	Max WS	A TR 30	-2.33	-0.57	1.52	-0.14	1.53	0.000079	-0.29	9.83	17.17	0.08
valle	23	Max WS	A TR 200	-2.36	-0.56	1.53	-0.10	1.53	0.000055	-0.26	11.02	17.54	0.07
valle	23	Max WS	A TR 30	-2.33	-0.56	1.53	-0.10	1.53	0.000054	-0.26	10.99	17.52	0.07
valle	20	Max WS	A TR 200	-2.36	-0.60	1.53	-0.27	1.53	0.000024	-0.20	13.96	17.21	0.05
valle	20	Max WS	A TR 30	-2.34	-0.60	1.53	-0.28	1.53	0.000024	-0.20	13.93	17.14	0.05
valle	19	Max WS	A TR 200	4.62	-0.52	1.52	-0.14	1.53	0.000058	0.31	15.12	8.73	0.07
valle	19	Max WS	A TR 30	4.43	-0.52	1.52	-0.15	1.53	0.000054	0.29	15.11	8.73	0.07
valle	18	Max WS	A TR 200	4.62	-0.62	1.51	0.01	1.53	0.000264	0.56	8.25	4.90	0.14
valle	18	Max WS	A TR 30	4.43	-0.62	1.51	-0.01	1.52	0.000243	0.54	8.25	4.90	0.13
valle	13	Max WS	A TR 200	4.62	-0.70	1.51	-0.17	1.52	0.000266	0.55	8.38	3.80	0.12
valle	13	Max WS	A TR 30	4.43	-0.70	1.51	-0.18	1.52	0.000245	0.53	8.38	3.80	0.11
valle	10	Max WS	A TR 200	-0.10	-0.73	1.50	-0.69	1.50	0.000000	-0.01	8.47	3.80	0.00
valle	10	Max WS	A TR 30	-0.10	-0.73	1.50	-0.69	1.50	0.000000	-0.01	8.47	3.80	0.00

Reach	River Sta	Profile	Plan	Q US	Q Leaving Total	Q DS	Q Weir	Q Gates	W/ Top Wdth	Weir Max Depth	Weir Avg Depth	Min El Weir Flow	E.G. US.	W.S. US.	E.G. DS	W.S. DS
				(m3/s)	(m3/s)	(m3/s)	(m3/s)	(m3/s)	(m)	(m)	(m)	(m)	(m)	(m)	(m)	(m)
vallecorsa	113.98	Max WS	A TR 200	23.41	14.84	6.07	14.84		233.66	0.39	0.09	7.52	11.40	10.61	7.80	7.70
vallecorsa	113.98	Max WS	A TR 30	12.43	6.32	6.04	6.32		219.80	0.19	0.06	7.52	10.85	10.41	7.80	7.70
vallecorsa	113.97	Max WS	A TR 200	23.41	2.50	6.07	2.50		33.05	0.25	0.11	8.09	11.40	10.61	7.80	7.70
vallecorsa	113.97	Max WS	A TR 30	12.43	0.07	6.04	0.07		10.13	0.05	0.02	8.09	10.85	10.41	7.80	7.70
vallecorsa	110.98	Max WS	A TR 200	6.07	3.21	2.85	3.21		83.34	0.15	0.07	6.47	7.62	7.42	6.27	6.21
vallecorsa	110.98	Max WS	A TR 30	6.04	3.19	2.85	3.19		82.99	0.15	0.07	6.47	7.62	7.42	6.27	6.21
vallecorsa	110.97	Max WS	A TR 200	6.07	0.00	2.85	0.00					6.95	7.62	7.42	6.27	6.21
vallecorsa	110.97	Max WS	A TR 30	6.04	0.00	2.85	0.00					6.95	7.62	7.42	6.27	6.21
vallecorsa	107.98	Max WS	A TR 200	2.85	0.00	2.85	0.00					4.79	5.95	5.76	4.47	4.45
vallecorsa	107.98	Max WS	A TR 30	2.85	0.00	2.85	0.00					4.79	5.95	5.76	4.47	4.45
vallecorsa	107.97	Max WS	A TR 200	2.85	0.00	2.85	0.00					4.50	5.95	5.76	4.47	4.45
vallecorsa	107.97	Max WS	A TR 30	2.85	0.00	2.85	0.00					4.50	5.95	5.76	4.47	4.45
valle	99.98	Max WS	A TR 200	7.10	0.15	6.92	0.15		6.19	0.11	0.05	2.26	4.22	4.05	2.49	2.37
valle	99.98	Max WS	A TR 30	7.08	0.15	6.90	0.15		6.15	0.11	0.05	2.26	4.22	4.05	2.49	2.37
valle	99.97	Max WS	A TR 200	7.10	3.30	3.65	3.30		186.50	0.19	0.04	1.59	4.22	4.05	1.80	1.76
valle	99.97	Max WS	A TR 30	7.08	3.29	3.65	3.29		186.47	0.19	0.04	1.59	4.22	4.05	1.80	1.76
valle	83.97	Max WS	A TR 200	3.65	1.12	2.52	1.12		48.25	0.09	0.05	1.38	1.53	1.51	1.48	1.47
valle	83.97	Max WS	A TR 30	3.63	1.11	2.52	1.11		48.10	0.09	0.05	1.38	1.53	1.50	1.48	1.47
valle	59.68	Max WS	A TR 200	2.52	2.17	-2.36	2.17		23.29	0.26	0.13	1.21	1.48	1.47	1.48	1.47
valle	59.68	Max WS	A TR 30	2.52	2.16	-2.33	2.16		23.24	0.26	0.13	1.21	1.48	1.47	1.48	1.47
valle	59.67	Max WS	A TR 200	2.52	3.72	-2.36	3.72		39.81	0.26	0.13	1.21	1.48	1.47	1.48	1.47
valle	59.67	Max WS	A TR 30	2.52	3.69	-2.33	3.69		39.72	0.26	0.13	1.21	1.48	1.47	1.48	1.47

Botro Iurco e botro Crocetta

Stato attuale e stato di progetto



None of the XS's are Geo-Referenced (Geo-Ref user entered XS, Geo-Ref interpolated XS, Non Geo-Ref user entered XS, Non Geo-Ref interpolated XS)

1 cm Horiz. = 68 m 1 cm Vert. = 55 m

1) A TR 200 1.5h 2) A TR 200 3h 3) A TR 30 1.5h

N.B. in grigio sono indicati gli sfioratori laterali in destra idrografica

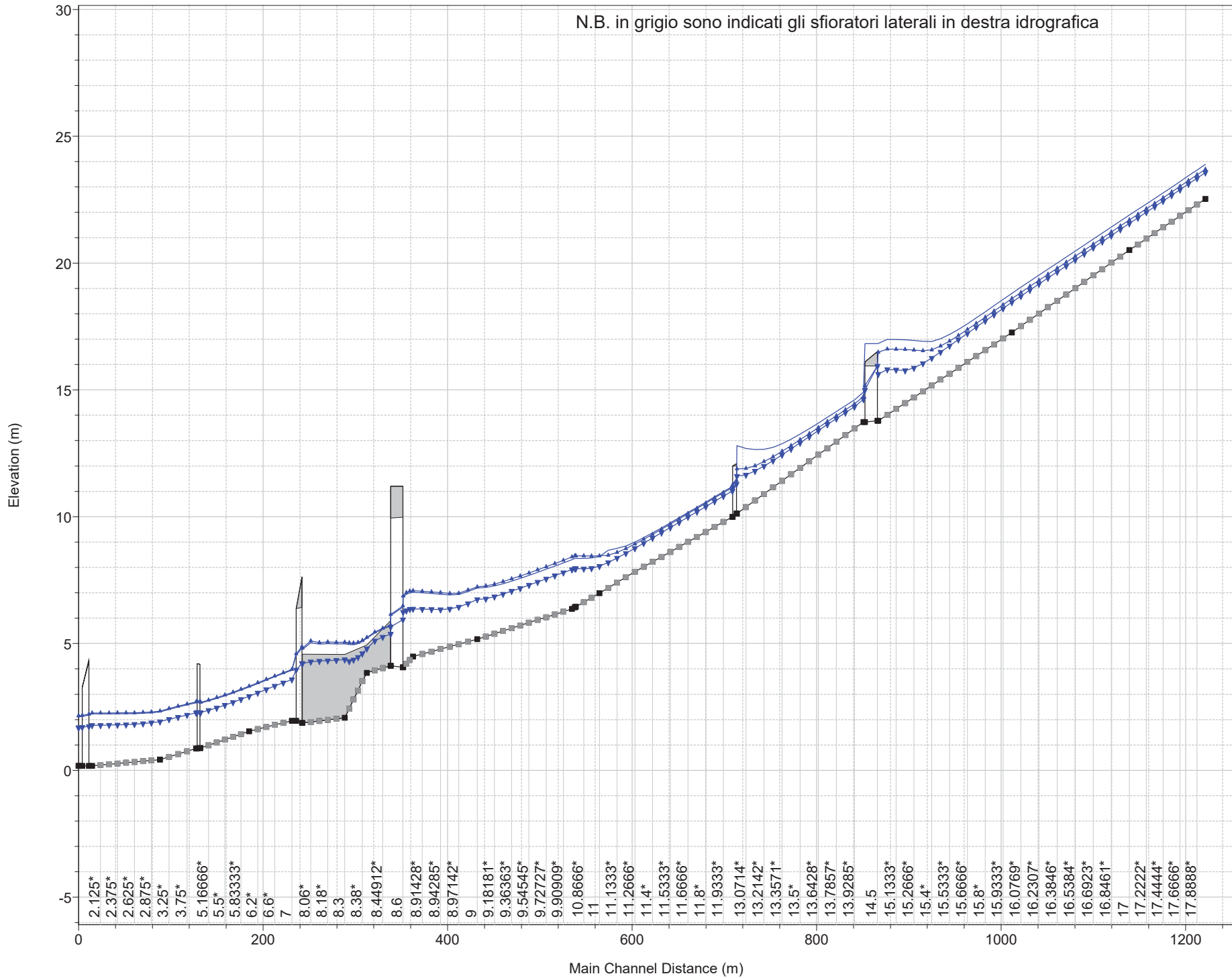

Legend	
WS Max WS - A TR 200 3h	▲
WS Max WS - A TR 200 1.5h	▼
WS Max WS - A TR 30 1.5h	▲
Ground	■

2.125* 2.375* 2.625* 2.875* 3.25* 3.75* 5.16666* 5.5* 5.83333* 6.2* 6.6* 7 8.06* 8.18* 8.3 8.38* 8.44912* 8.6 8.91428* 8.94285* 8.97142* 9 9.18181* 9.36363* 9.54545* 9.72727* 9.90909* 10.8666* 11 11.1333* 11.2666* 11.4* 11.5333* 11.6666* 11.8* 11.9333* 13.0714* 13.2142* 13.3571* 13.5* 13.6428* 13.7857* 13.9285* 14.5 15.1333* 15.2666* 15.4* 15.5333* 15.6666* 15.8* 15.9333* 16.0769* 16.2307* 16.3846* 16.5384* 16.6923* 16.8461* 17 17.2222* 17.4444* 17.6666* 17.8888*

1 cm Horiz. = 55 m 1 cm Vert. = 2 m

1) A TR 200 1.5h 2) A TR 200 3h 3) A TR 30 1.5h

N.B. in grigio sono indicati gli sfioratori laterali in sinistra idrografica

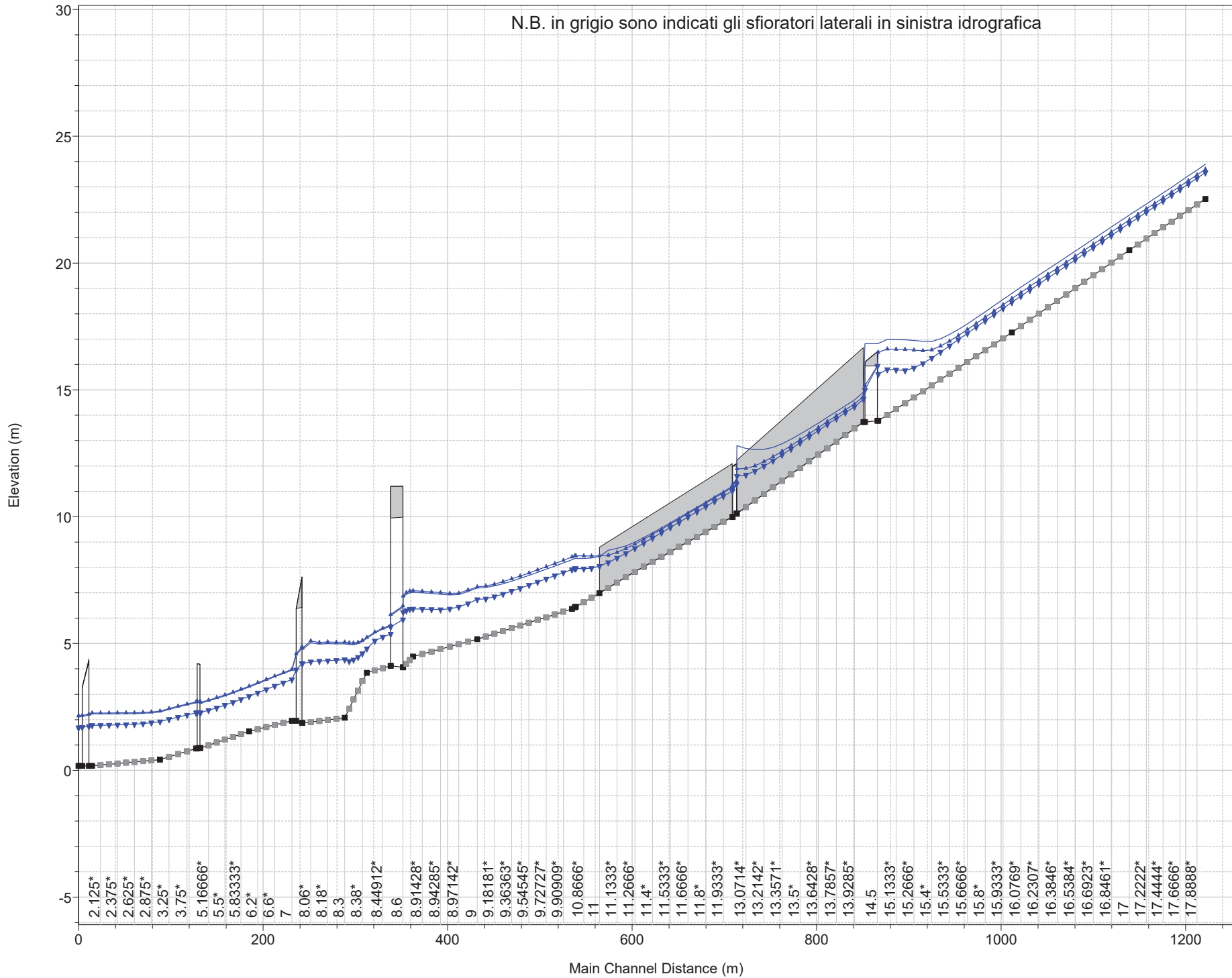

Legend	
WS Max WS - A TR 200 3h	▲
WS Max WS - A TR 200 1.5h	▼
WS Max WS - A TR 30 1.5h	▲
Ground	■

1 cm Horiz. = 55 m 1 cm Vert. = 2 m

1) A TR 200 1.5h 2) A TR 200 3h 3) A TR 30 1.5h

Crocetta Crocetta

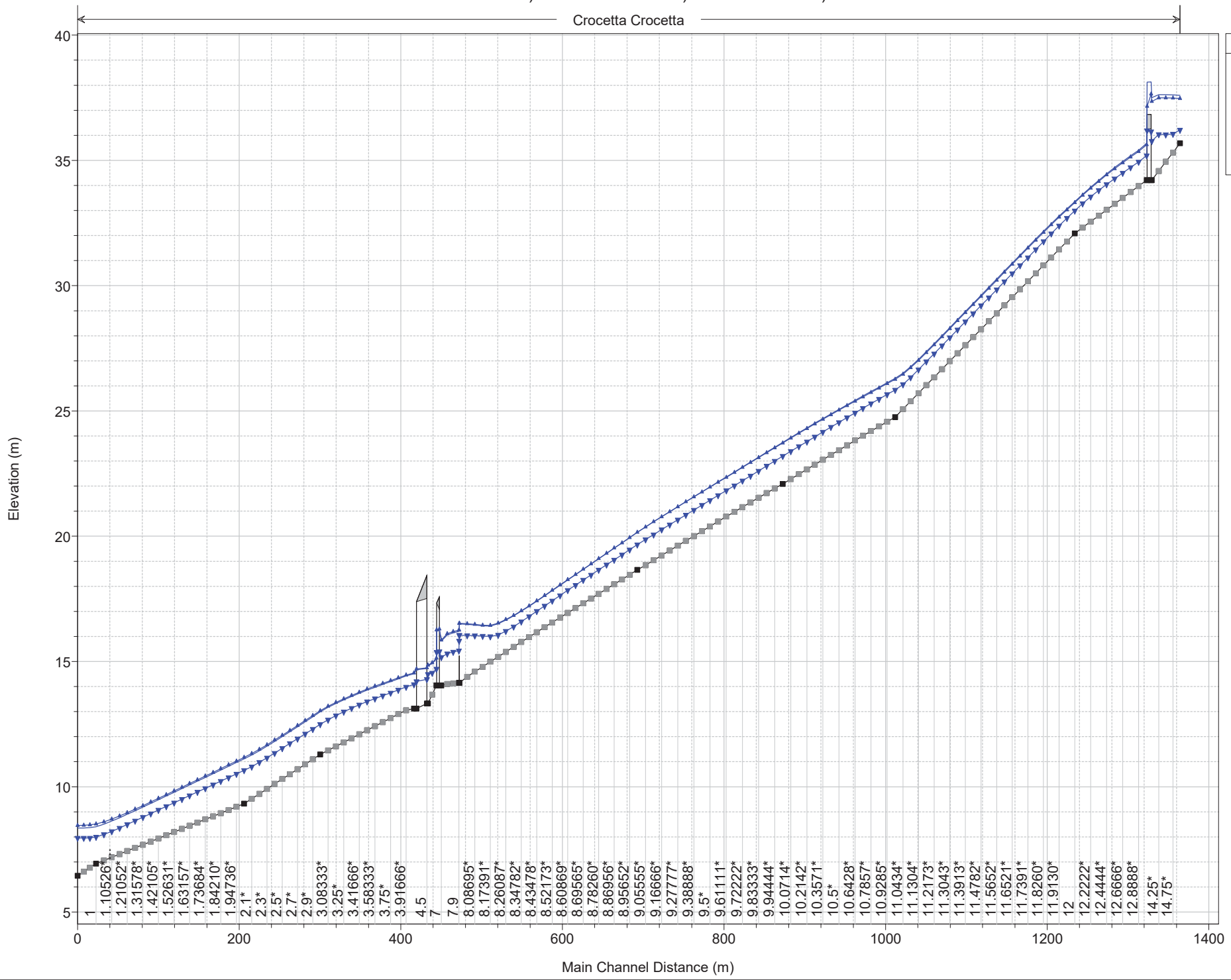

Legend

- WS Max WS - A TR 200 3h
- WS Max WS - A TR 200 1.5h
- WS Max WS - A TR 30 1.5h
- Ground

1 cm Horiz. = 62 m 1 cm Vert. = 2 m

1) A TR 200 1.5h 2) A TR 200 3h 3) A TR 30 1.5h

River = Iurco Reach = Iurco RS = 18 Sez. 1

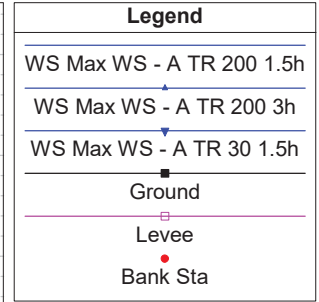
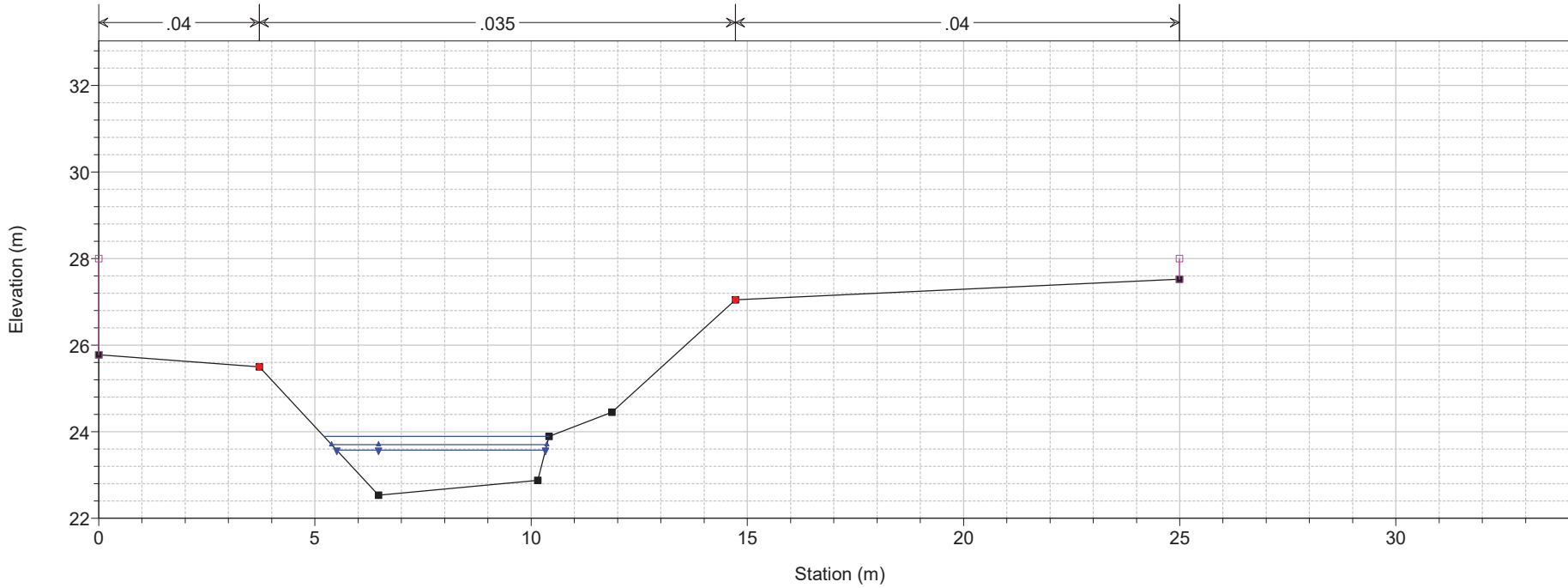

1) A TR 200 1.5h 2) A TR 200 3h 3) A TR 30 1.5h

River = Iurco Reach = Iurco RS = 17 Sez. 2

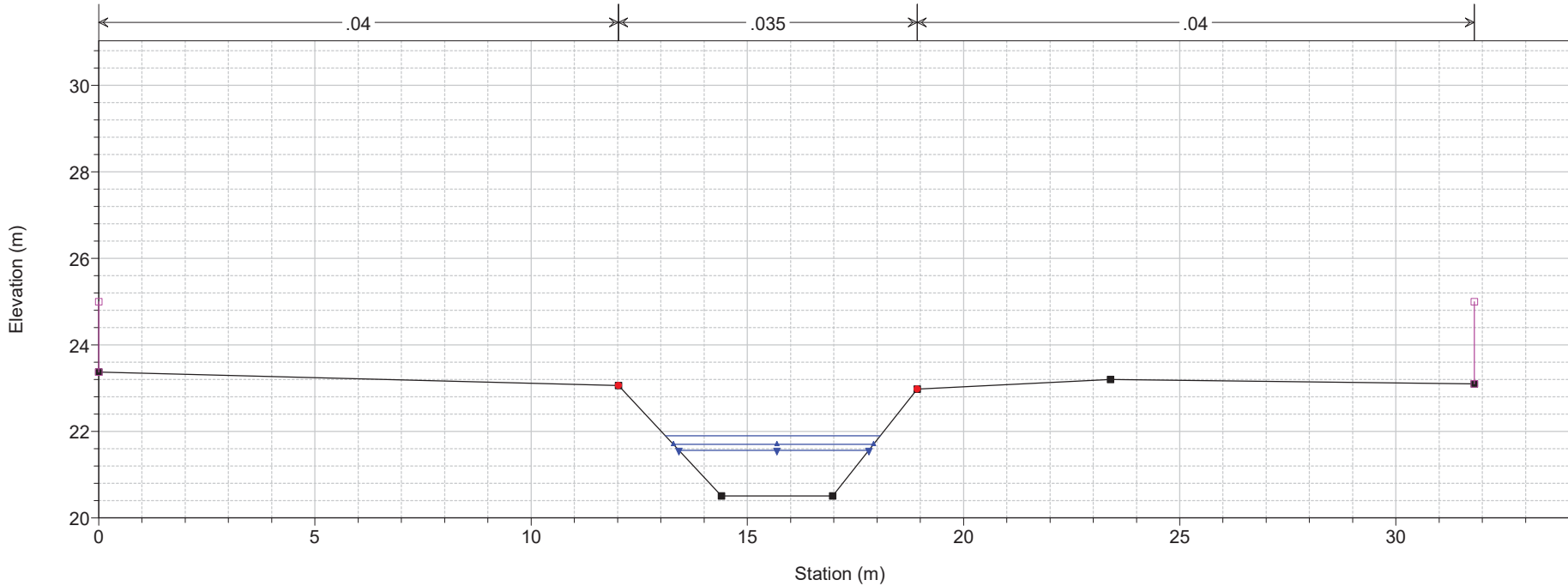

1) A TR 200 1.5h 2) A TR 200 3h 3) A TR 30 1.5h

River = Iurco Reach = Iurco RS = 16 Sez. 3

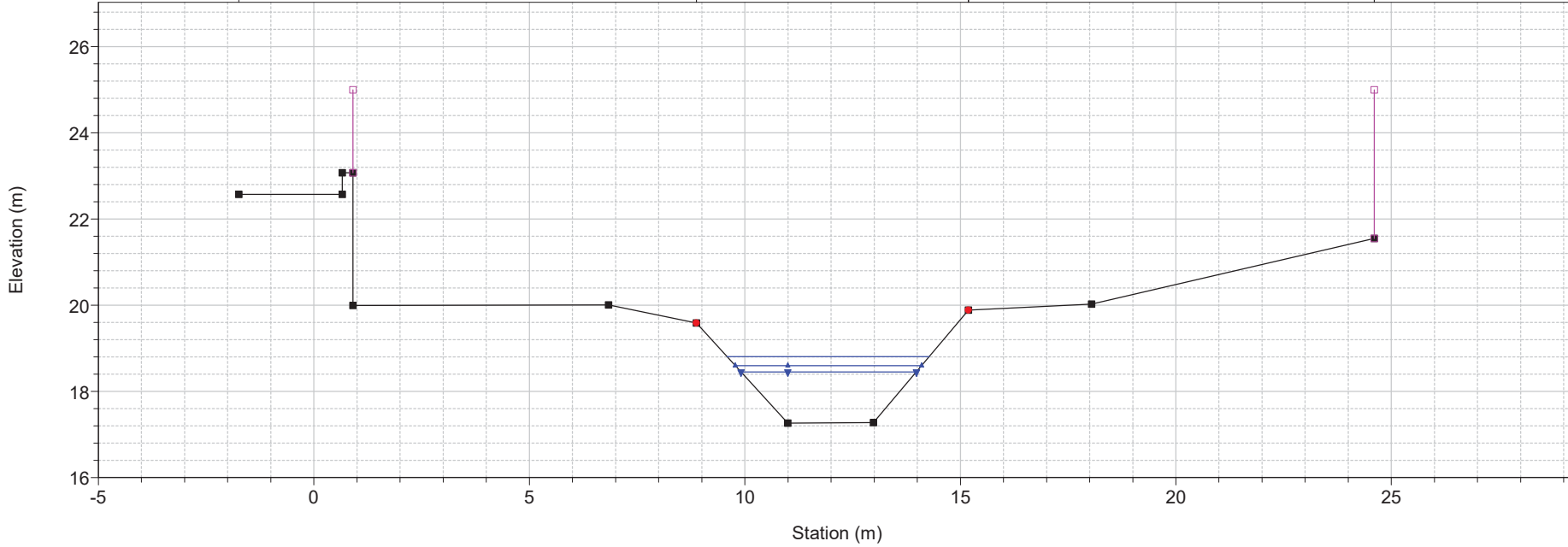
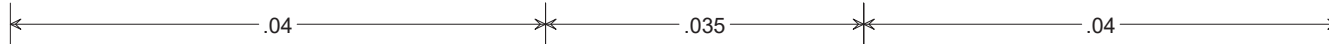

1) A TR 200 1.5h 2) A TR 200 3h 3) A TR 30 1.5h

River = Iurco Reach = Iurco RS = 15 Sez. 4

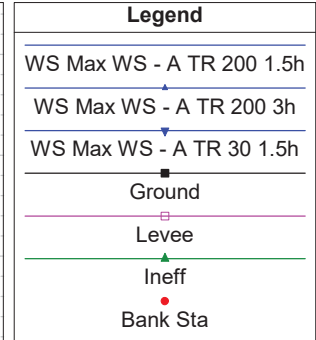
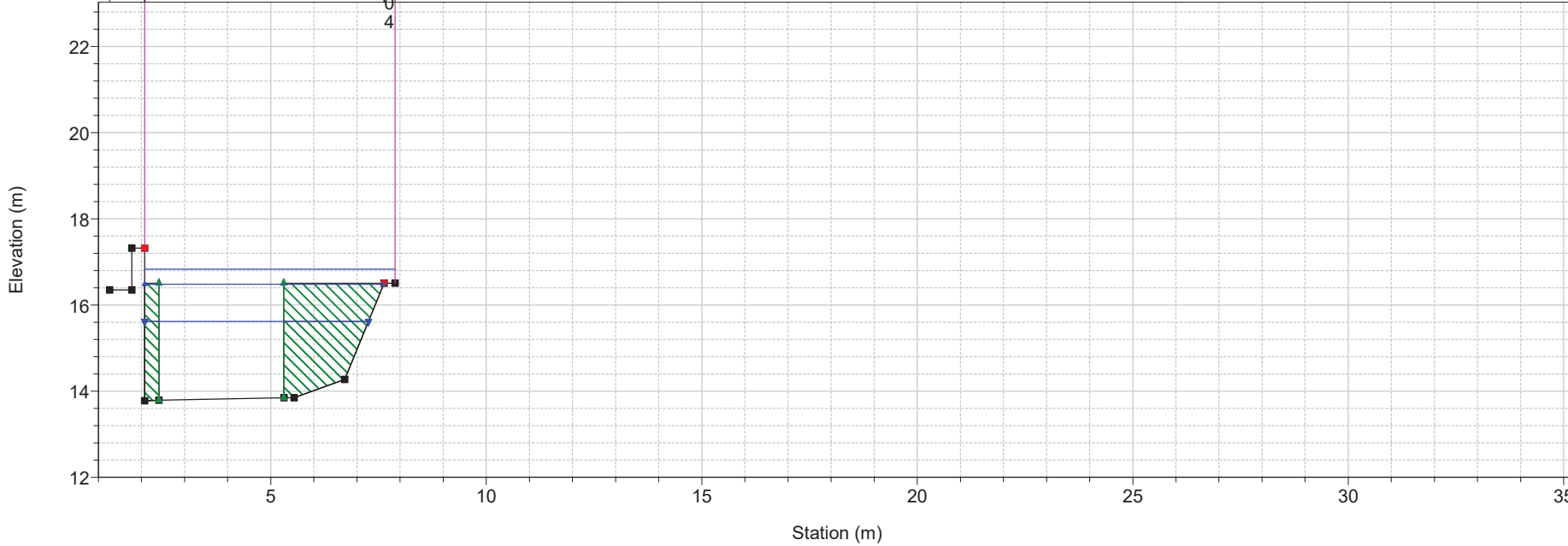
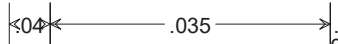

1) A TR 200 1.5h 2) A TR 200 3h 3) A TR 30 1.5h

River = Iurco Reach = Iurco RS = 14.5 BR

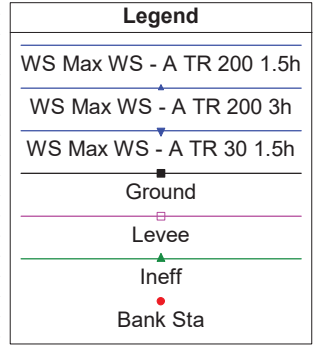
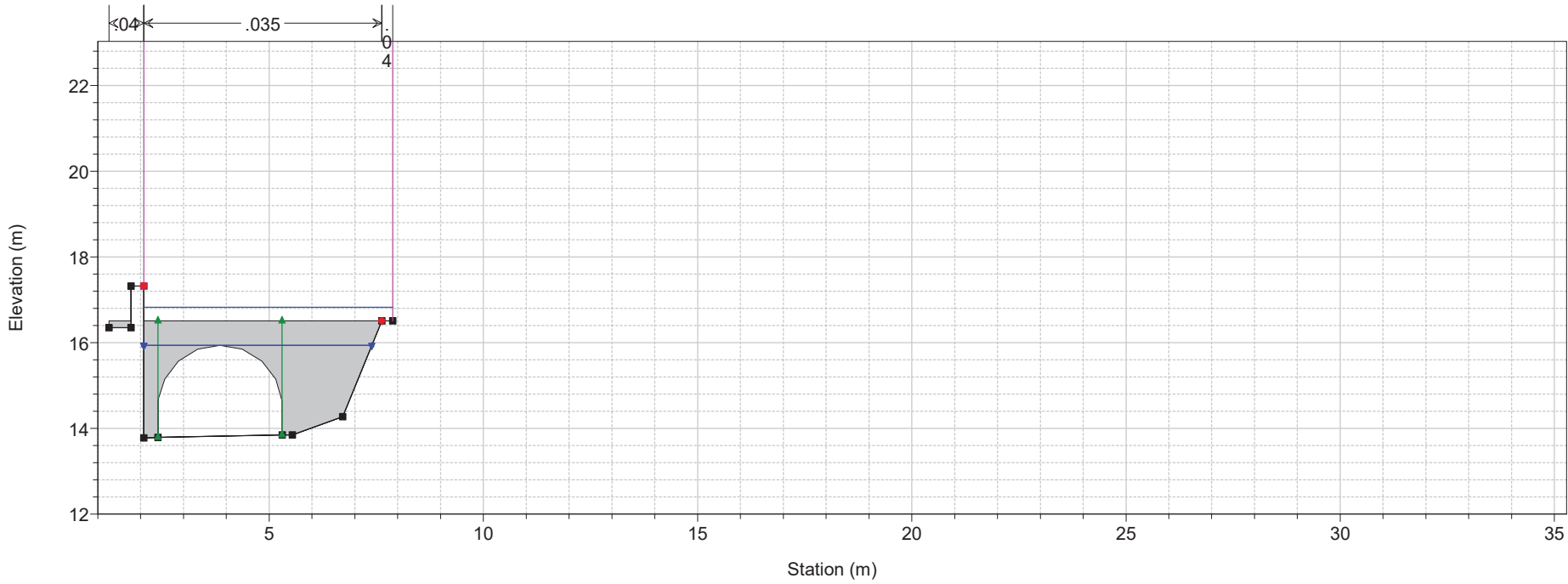

1) A TR 200 1.5h 2) A TR 200 3h 3) A TR 30 1.5h

River = Iurco Reach = Iurco RS = 14.5 BR

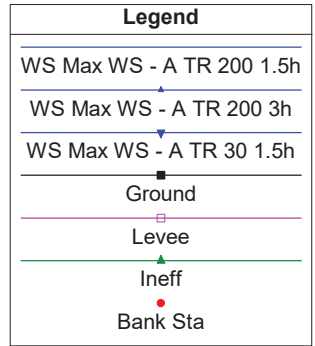
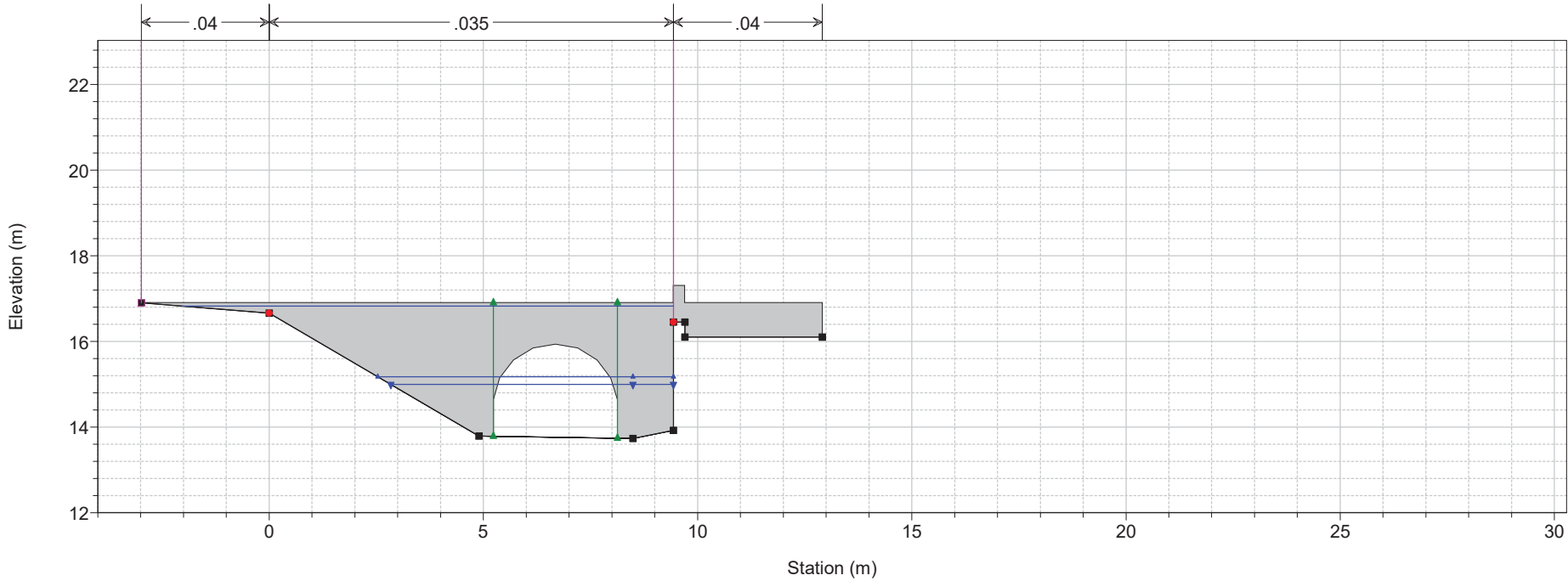

1) A TR 200 1.5h 2) A TR 200 3h 3) A TR 30 1.5h

River = Iurco Reach = Iurco RS = 14 Sez. 5

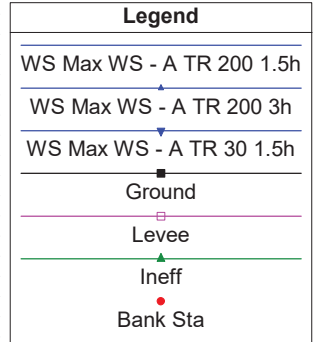
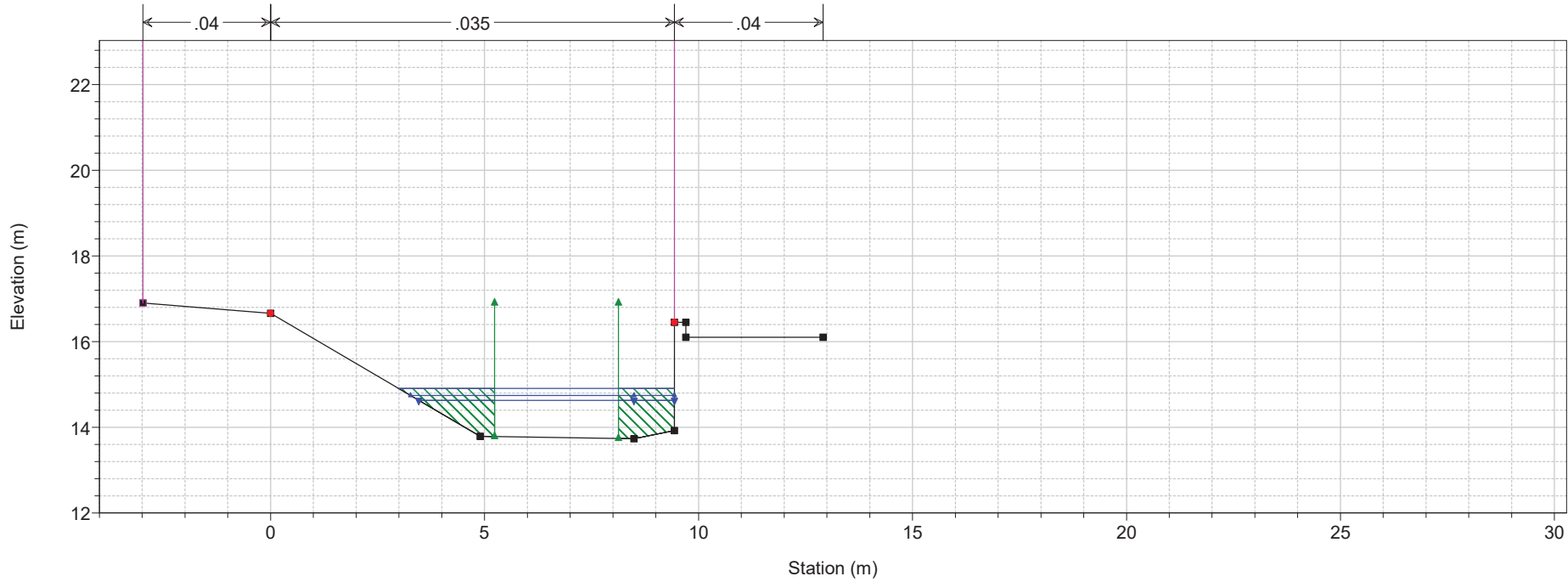

1) A TR 200 1.5h 2) A TR 200 3h 3) A TR 30 1.5h

River = Iurco Reach = Iurco RS = 13 Sez. 6

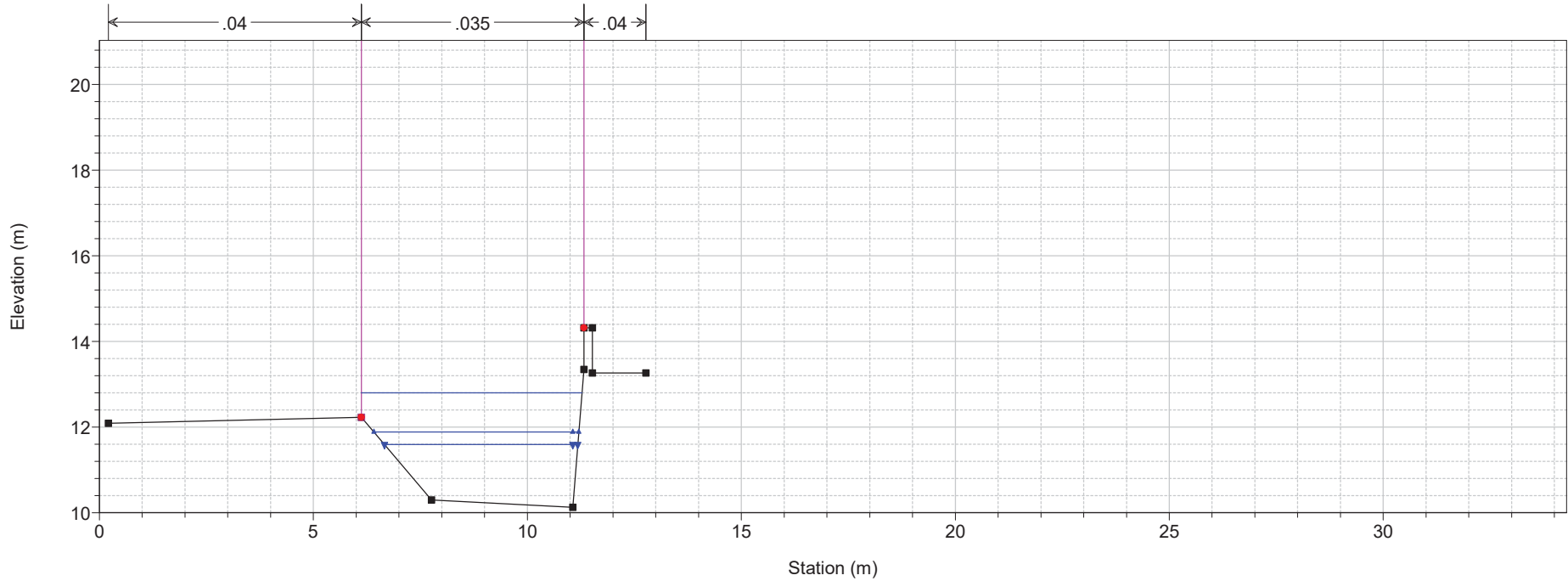

1 cm Horiz. = 1.5 m 1 cm Vert. = 1.5 m

1) A TR 200 1.5h 2) A TR 200 3h 3) A TR 30 1.5h

River = Iurco Reach = Iurco RS = 12.5 BR

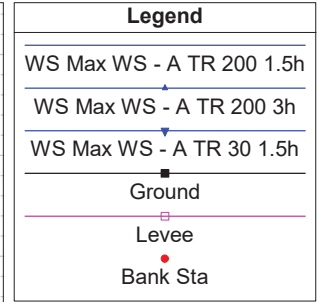
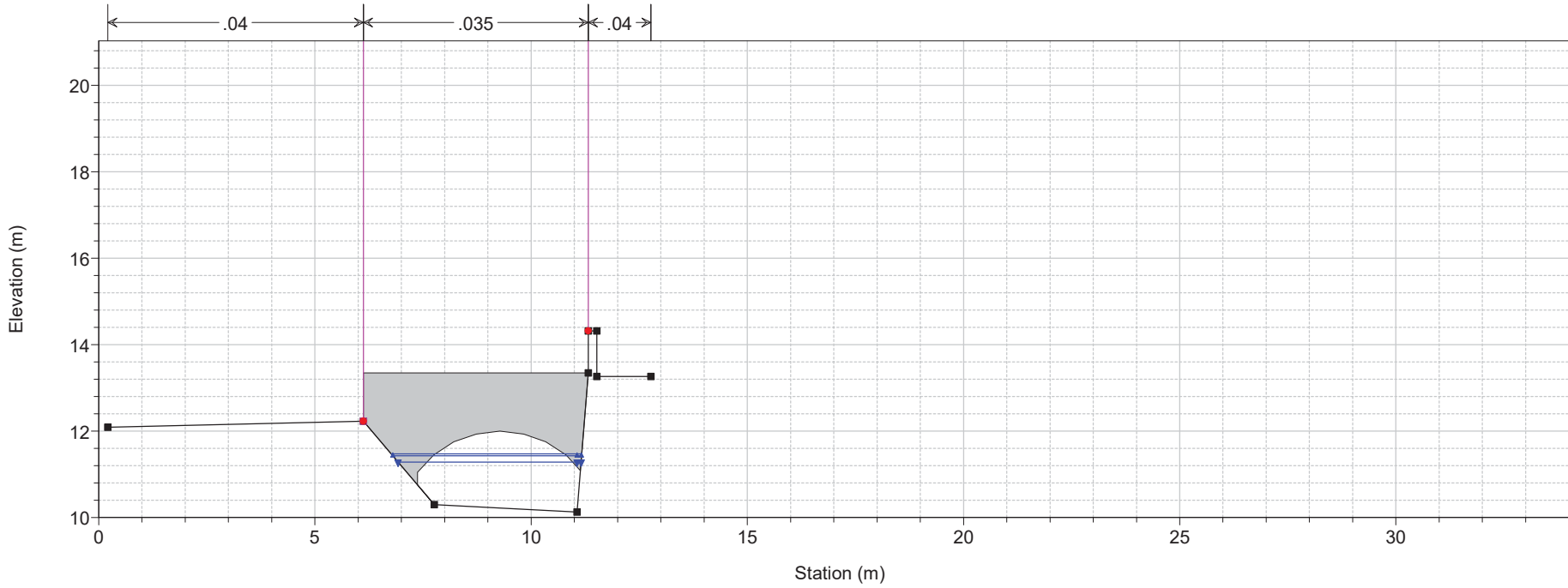

1) A TR 200 1.5h 2) A TR 200 3h 3) A TR 30 1.5h

River = Iurco Reach = Iurco RS = 12.5 BR

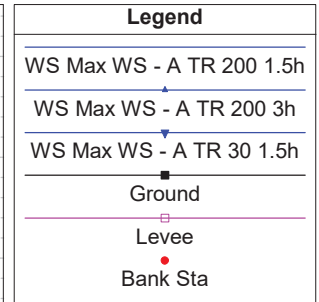
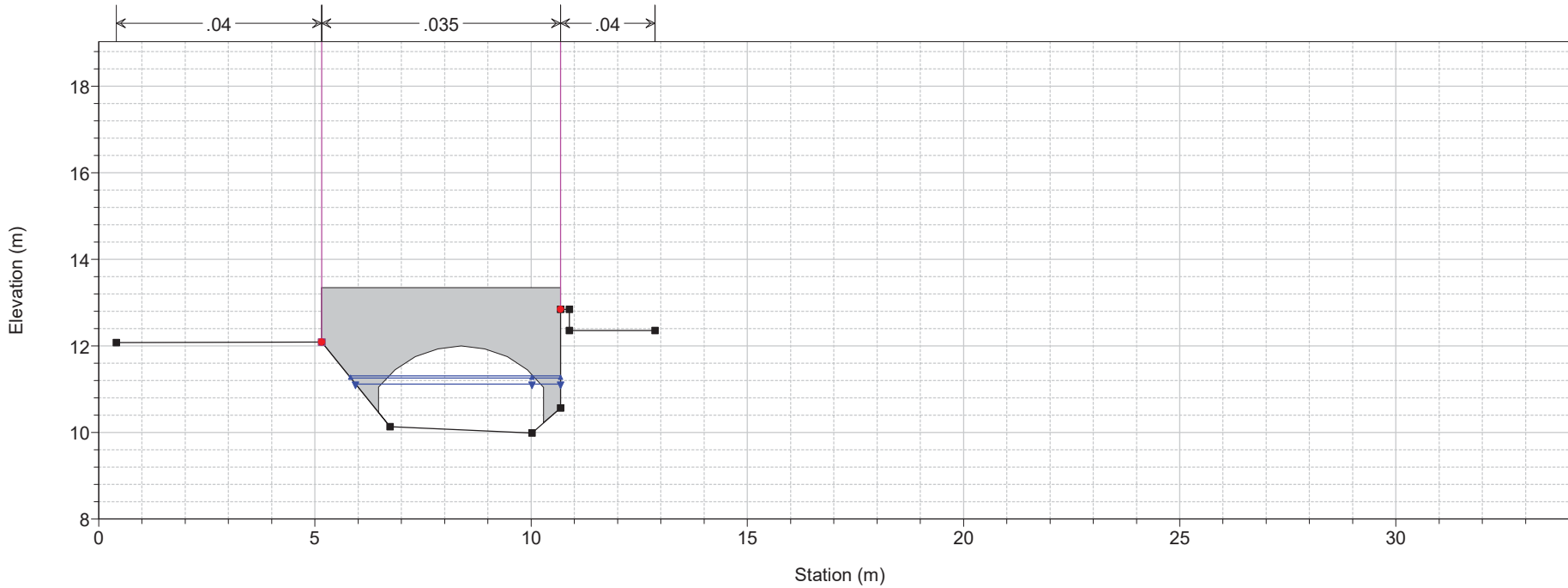

1) A TR 200 1.5h 2) A TR 200 3h 3) A TR 30 1.5h

River = Iurco Reach = Iurco RS = 12 Sez. 7

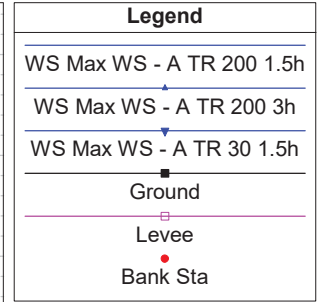
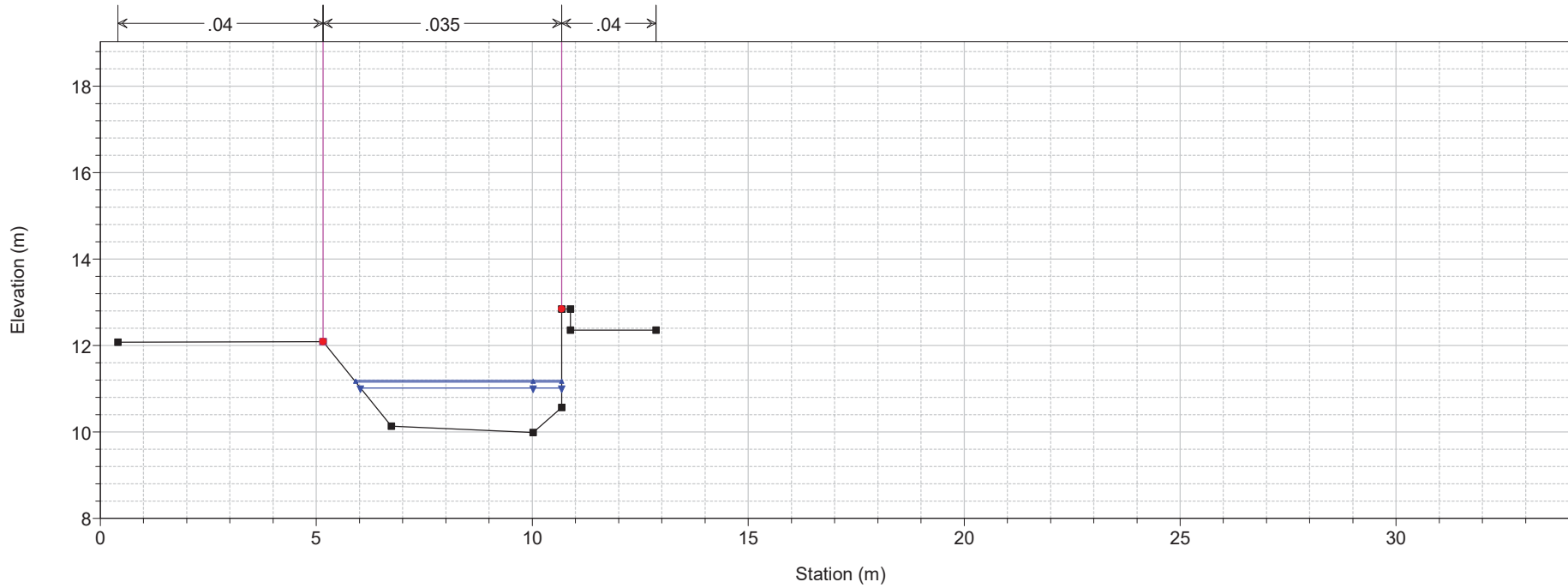

1) A TR 200 1.5h 2) A TR 200 3h 3) A TR 30 1.5h

River = Iurco Reach = Iurco RS = 11 Sez. 8

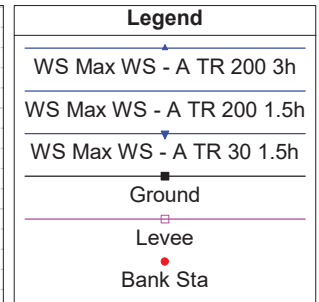
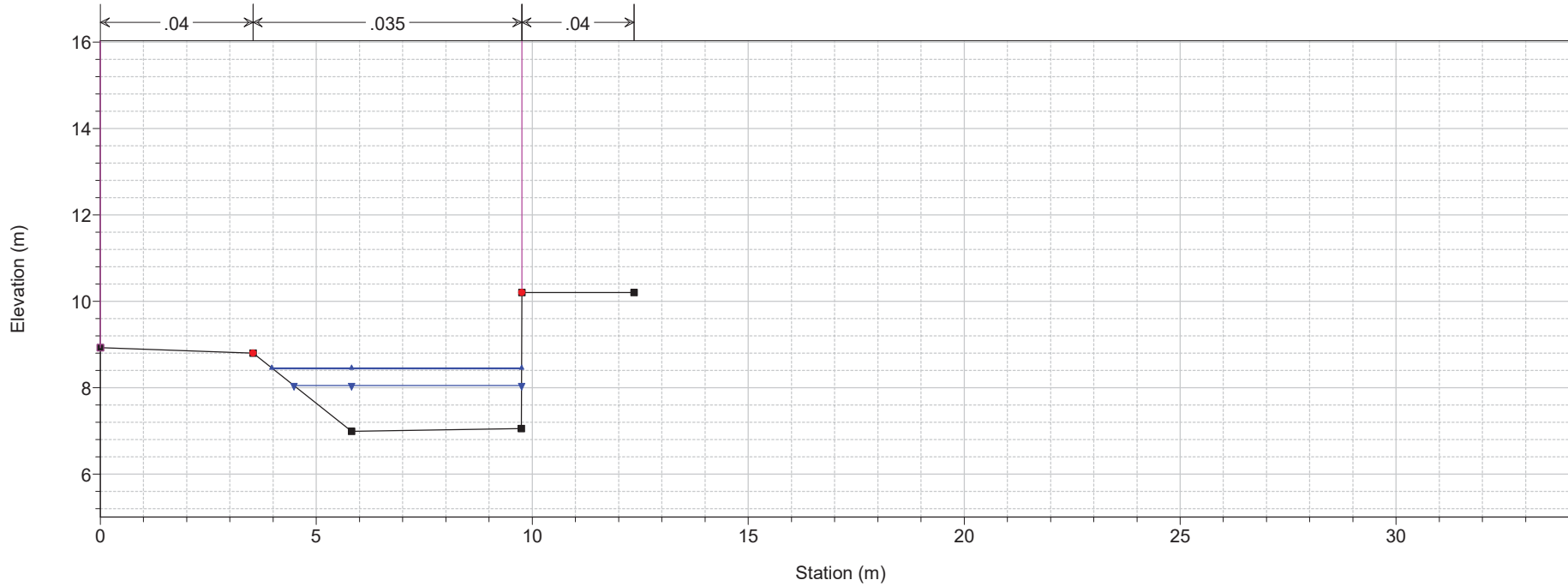

1) A TR 200 1.5h 2) A TR 200 3h 3) A TR 30 1.5h

River = Iurco Reach = Iurco RS = 10.8

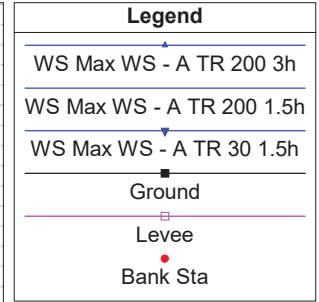
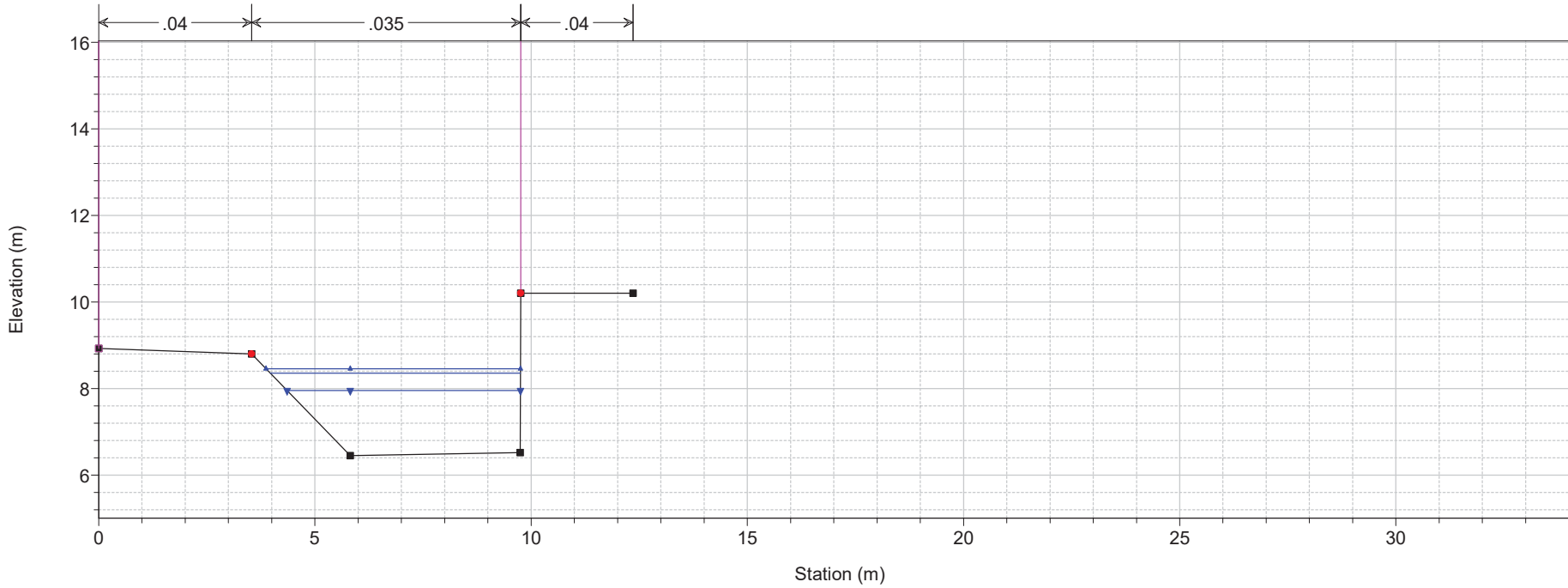

1) A TR 200 1.5h 2) A TR 200 3h 3) A TR 30 1.5h

River = Iurco Reach = Iurco_valle RS = 10.2

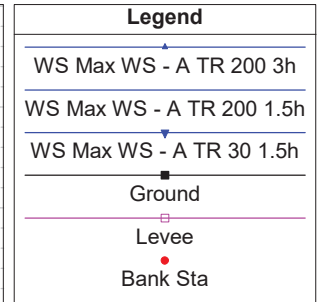
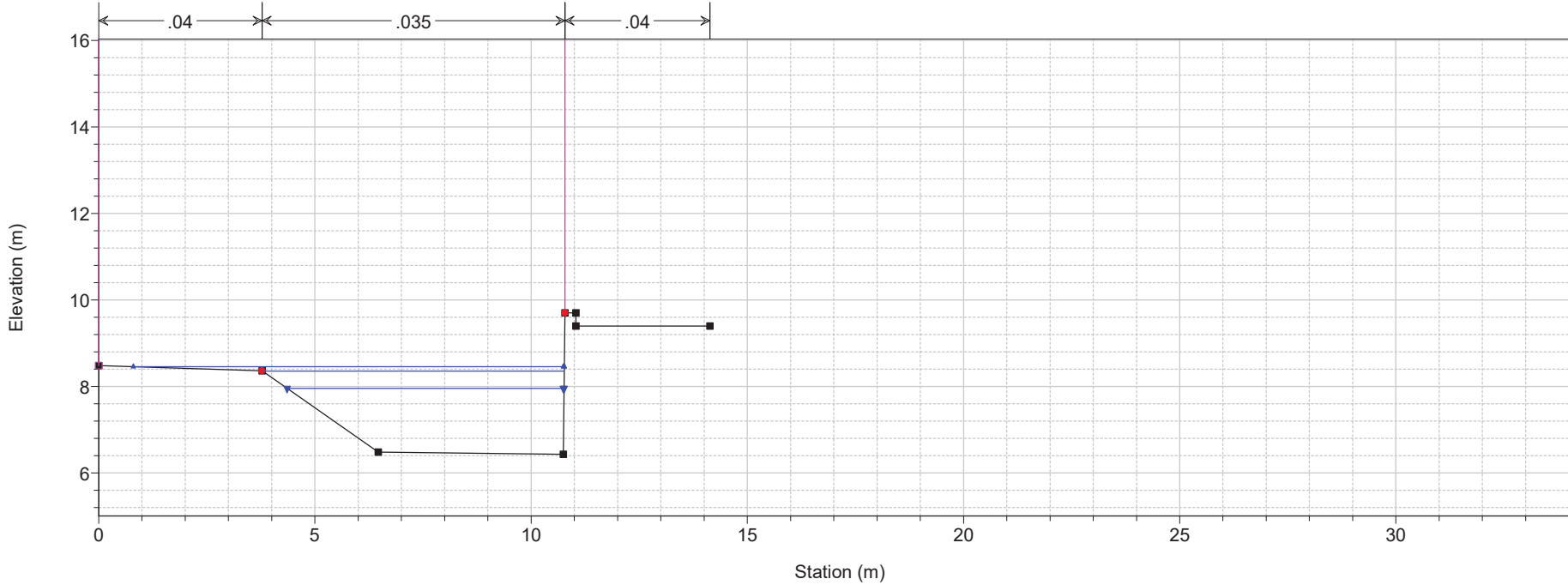

1) A TR 200 1.5h 2) A TR 200 3h 3) A TR 30 1.5h

River = lurco Reach = lurco_valle RS = 10 Sez. 9

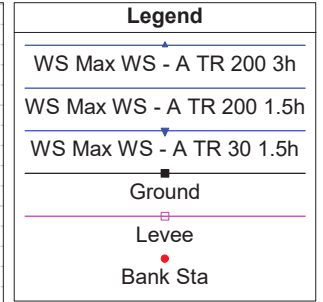
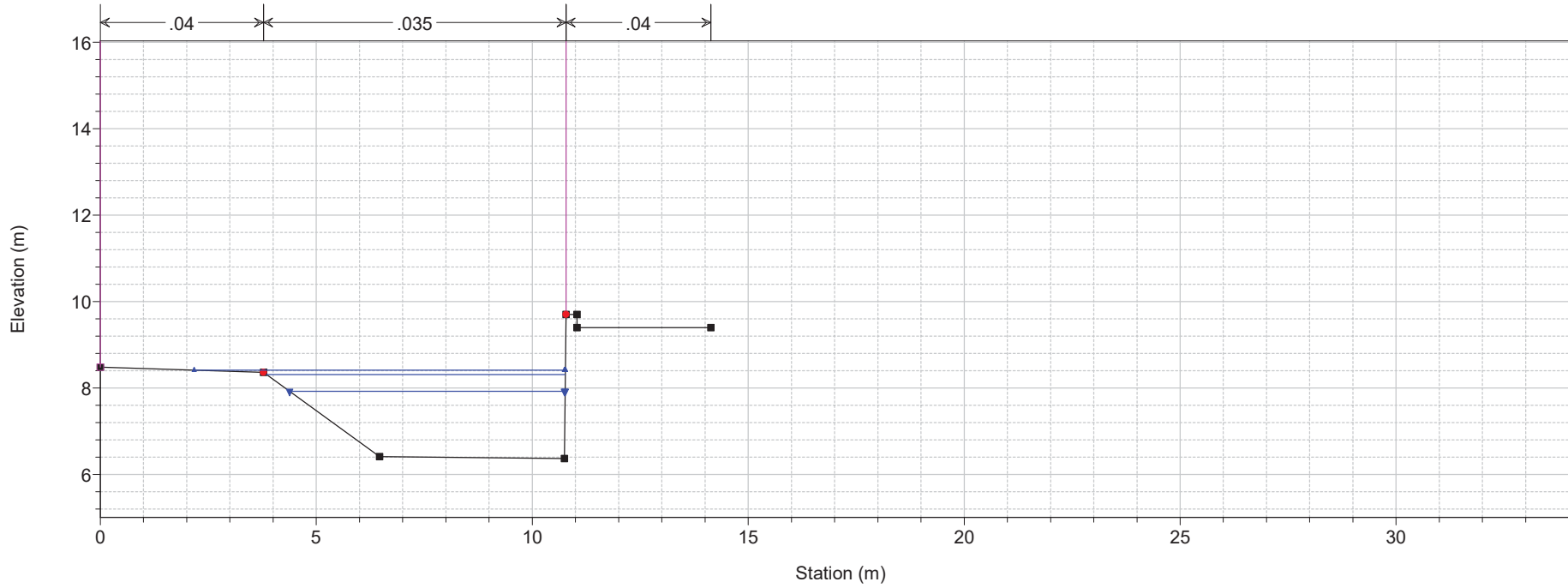

1) A TR 200 1.5h 2) A TR 200 3h 3) A TR 30 1.5h

River = lurco Reach = lurco_valle RS = 9 Sez. 10

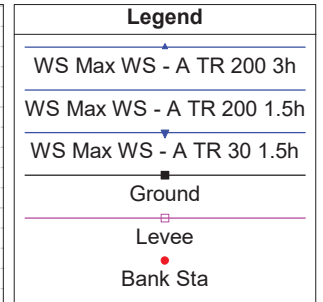
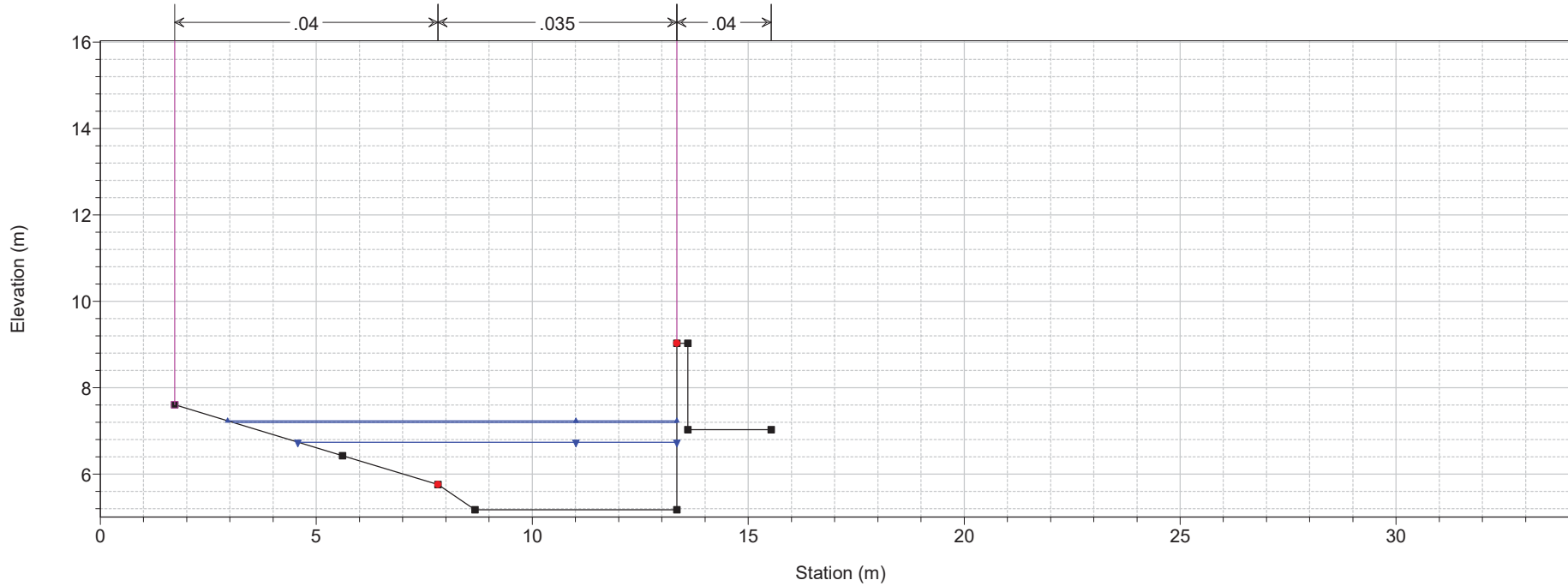

1 cm Horiz. = 1.5 m 1 cm Vert. = 1.5 m

1) A TR 200 1.5h 2) A TR 200 3h 3) A TR 30 1.5h

River = Iurco Reach = Iurco_valle RS = 8.9 sez 1

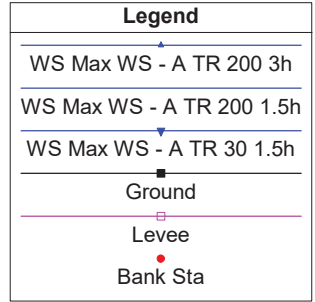
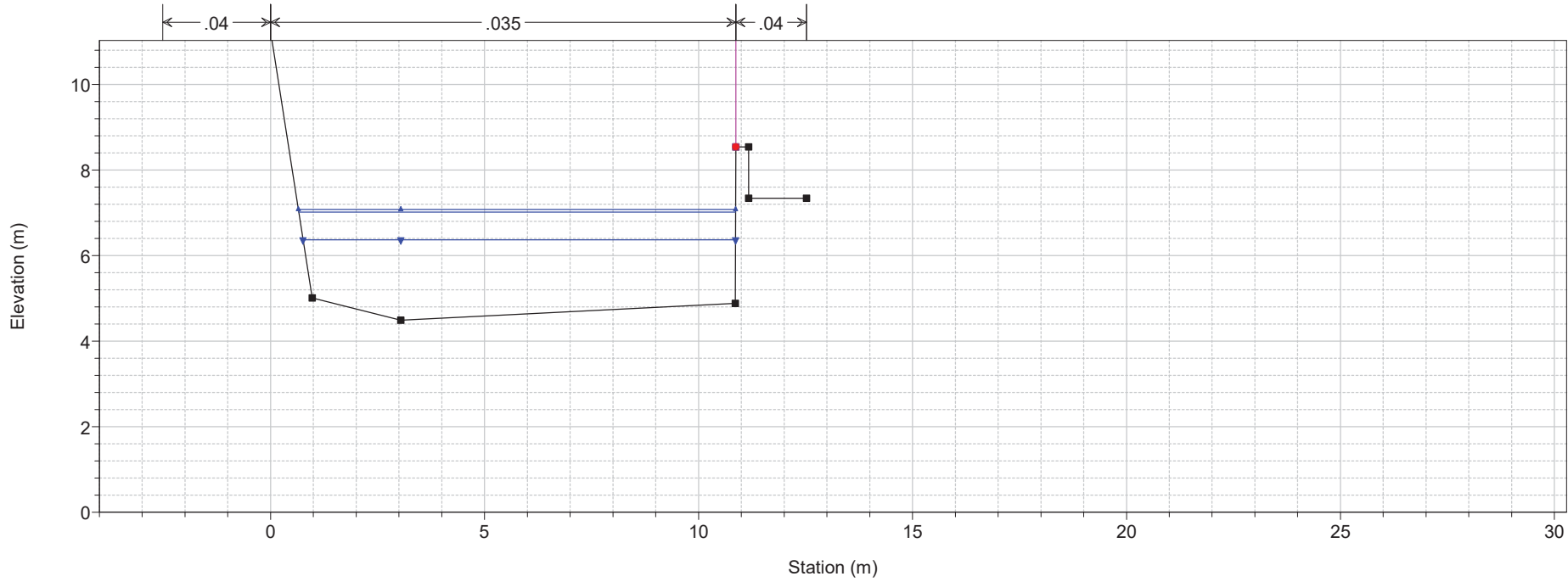

1) A TR 200 1.5h 2) A TR 200 3h 3) A TR 30 1.5h

River = Iurco Reach = Iurco_valle RS = 8.8 sez 2

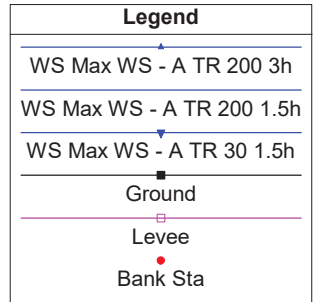
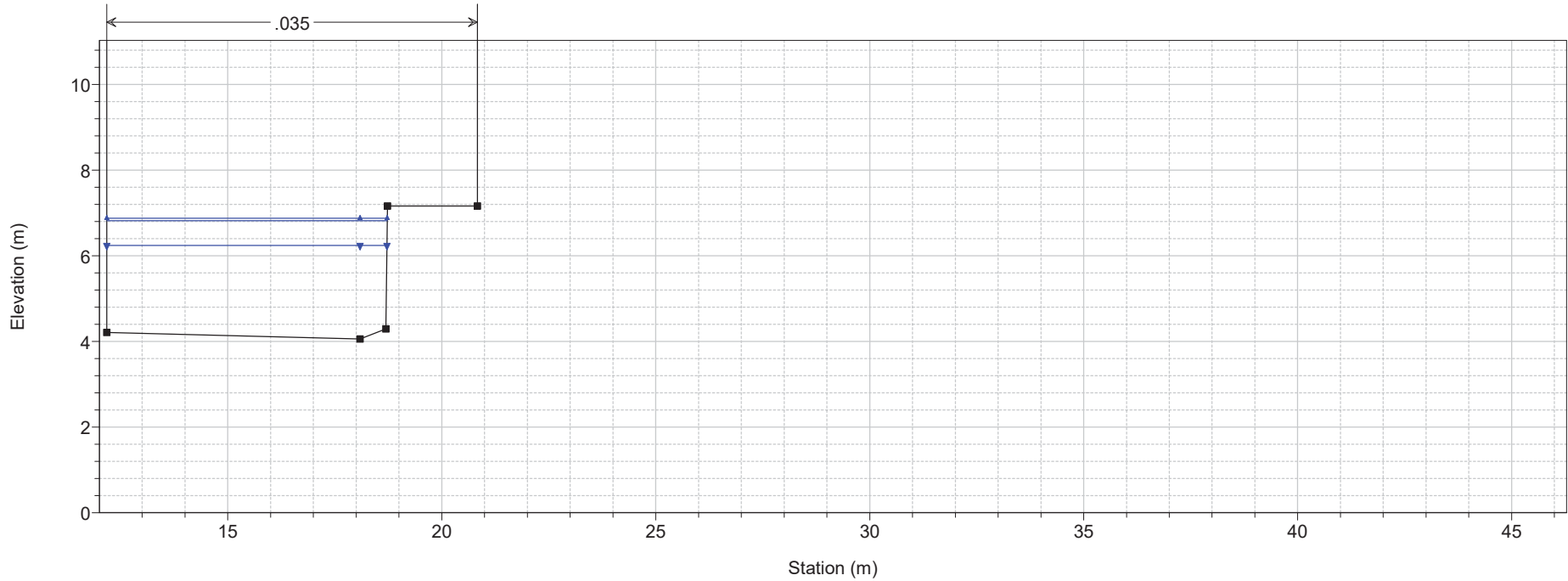

1) A TR 200 1.5h 2) A TR 200 3h 3) A TR 30 1.5h

River = Iurco Reach = Iurco_valle RS = 8.6 BR

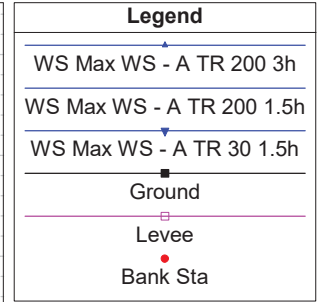
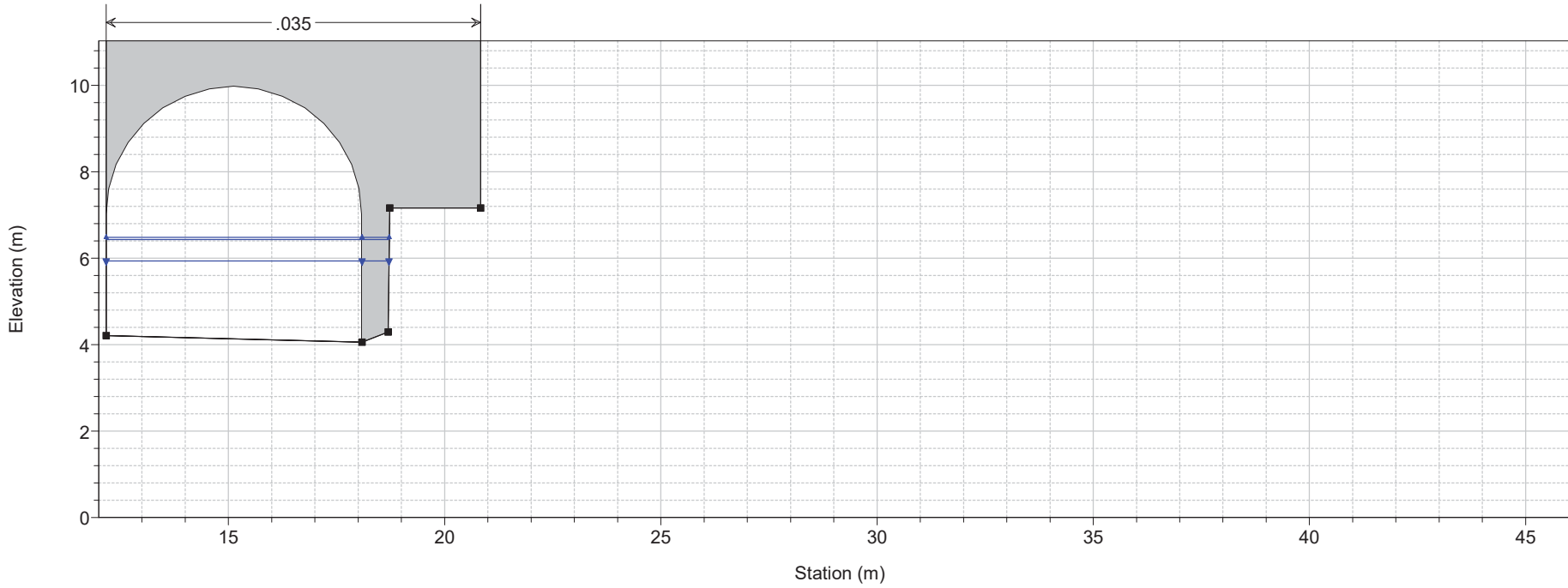

1) A TR 200 1.5h 2) A TR 200 3h 3) A TR 30 1.5h

River = Iurco Reach = Iurco_valle RS = 8.6 BR

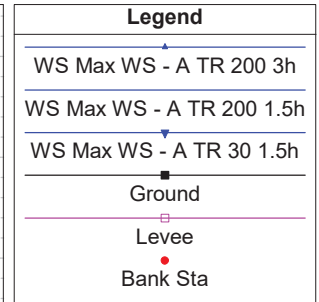
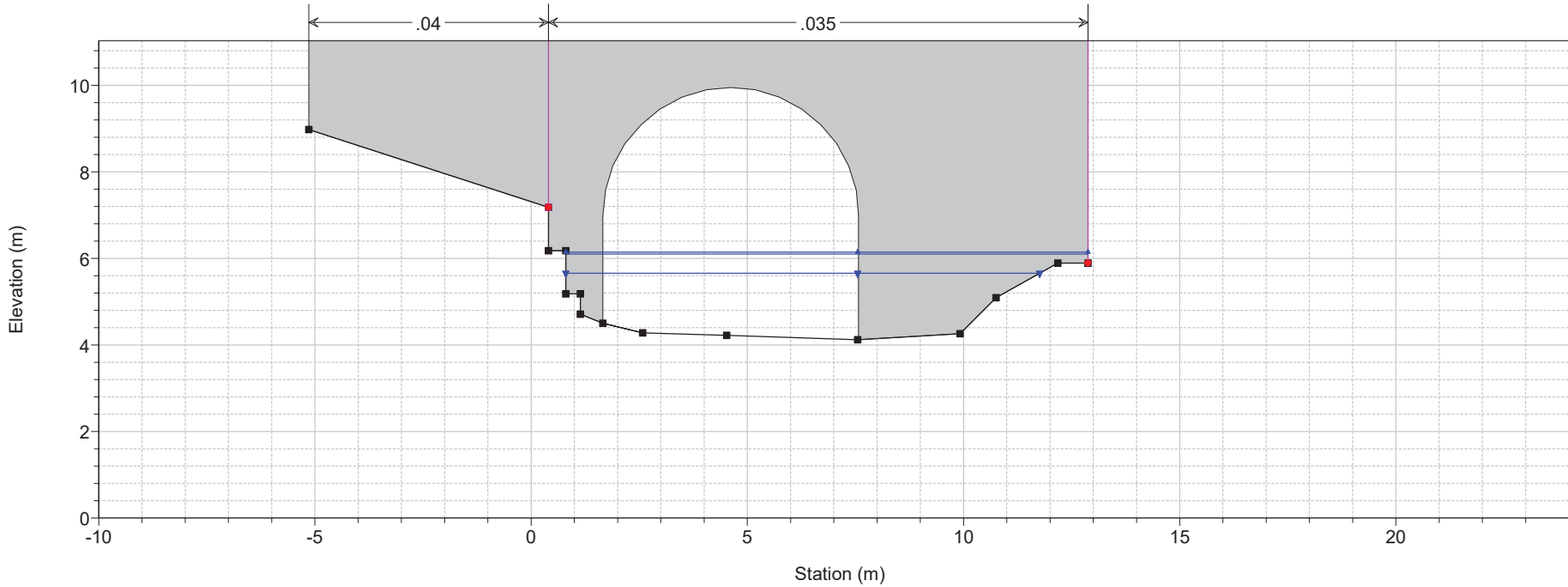

1) A TR 200 1.5h 2) A TR 200 3h 3) A TR 30 1.5h
 River = lurco Reach = lurco_valle RS = 8.47368 sez 3

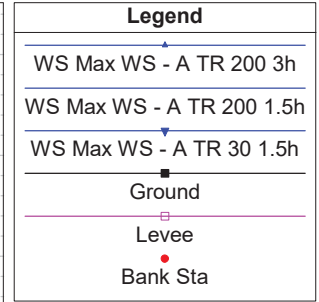
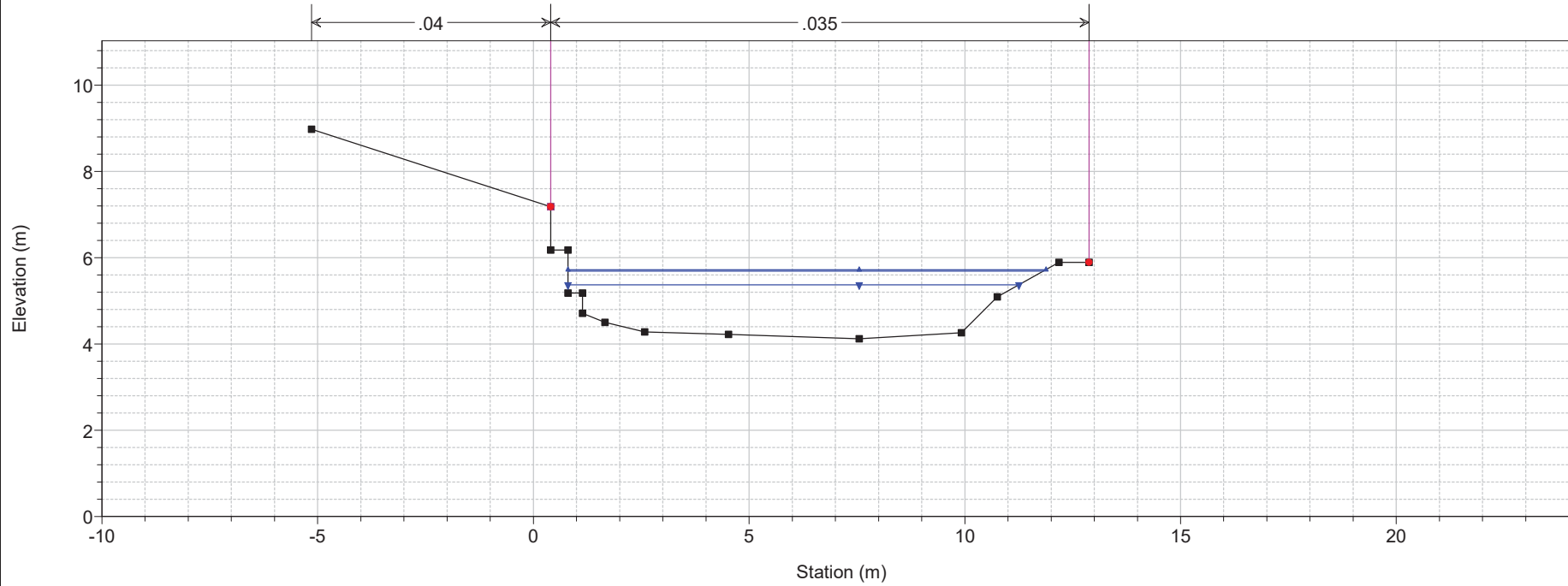

1) A TR 200 1.5h 2) A TR 200 3h 3) A TR 30 1.5h
 River = lurco Reach = lurco_valle RS = 8.4 sez 4

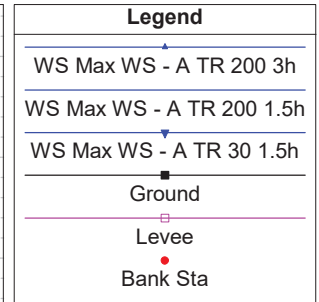
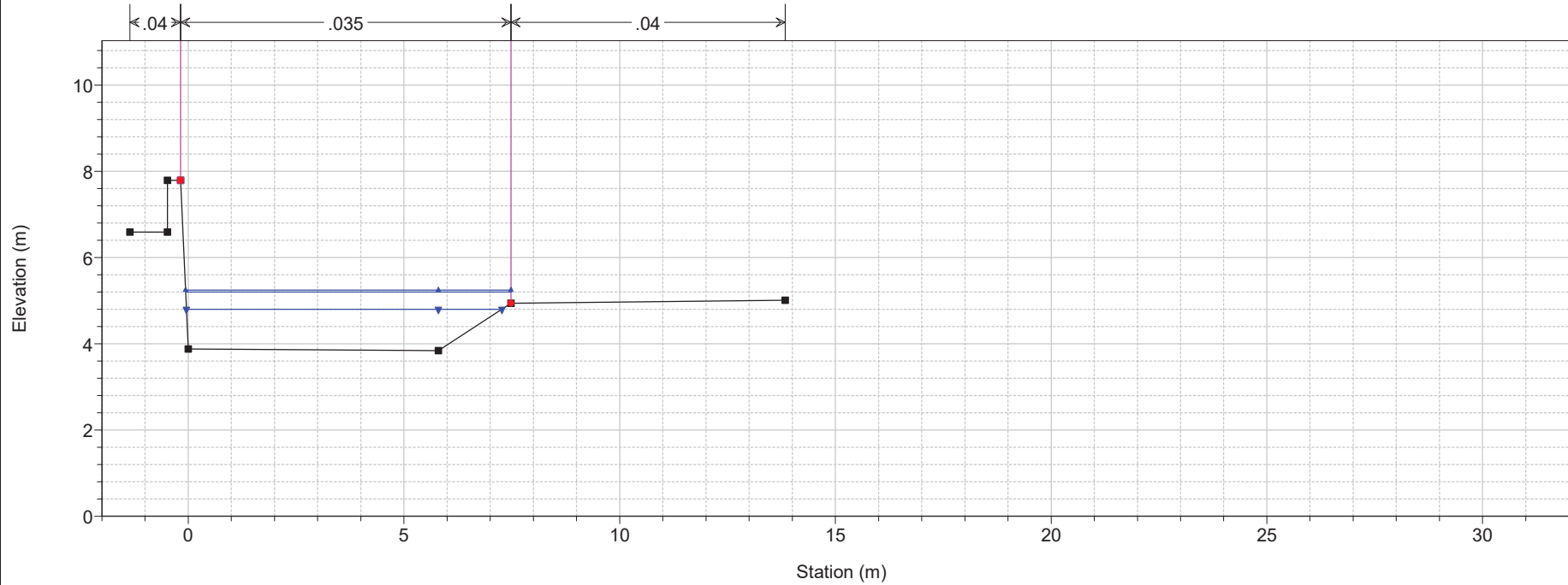

1) A TR 200 1.5h 2) A TR 200 3h 3) A TR 30 1.5h

River = lurco Reach = lurco_valle RS = 8.3

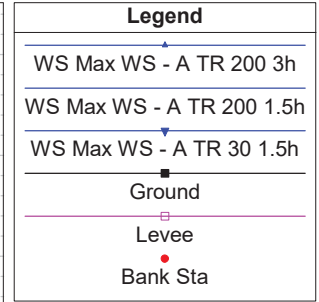
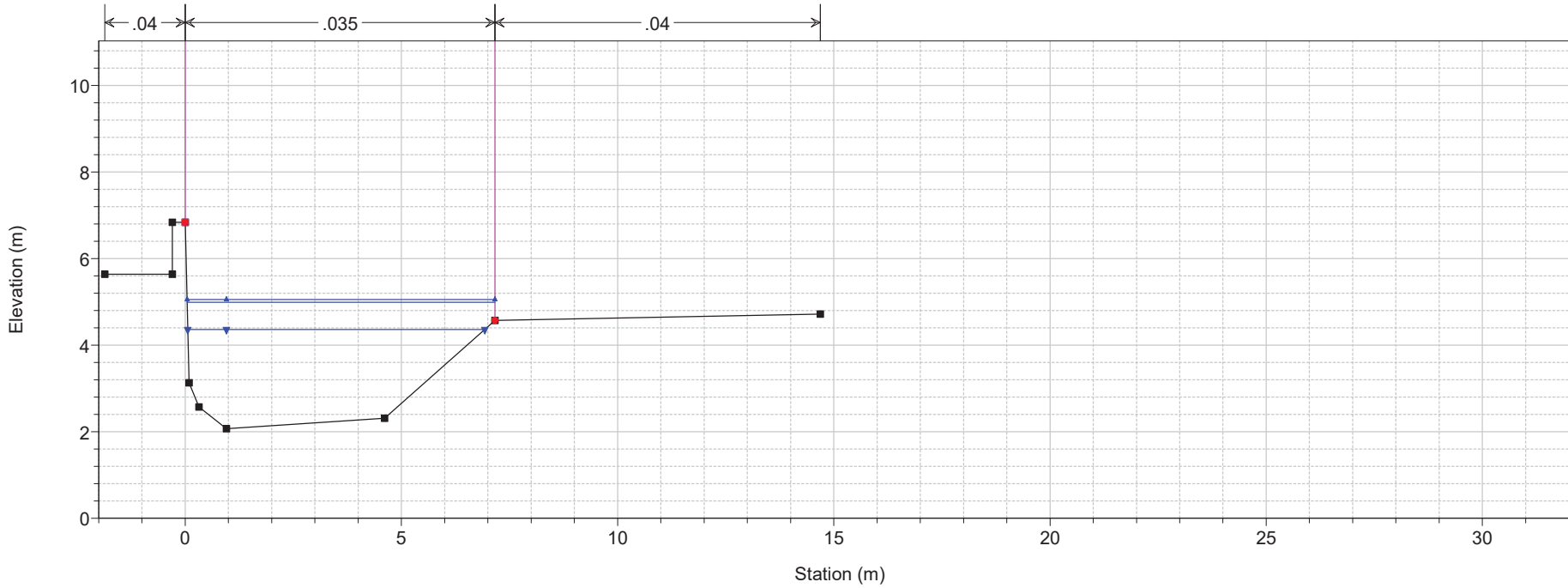

1) A TR 200 1.5h 2) A TR 200 3h 3) A TR 30 1.5h

River = lurco Reach = lurco_valle RS = 8 Sez. 11

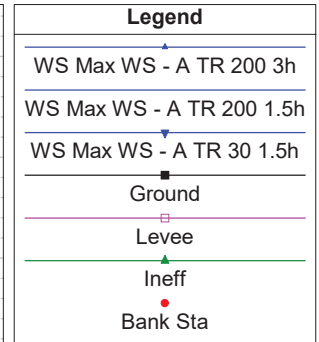
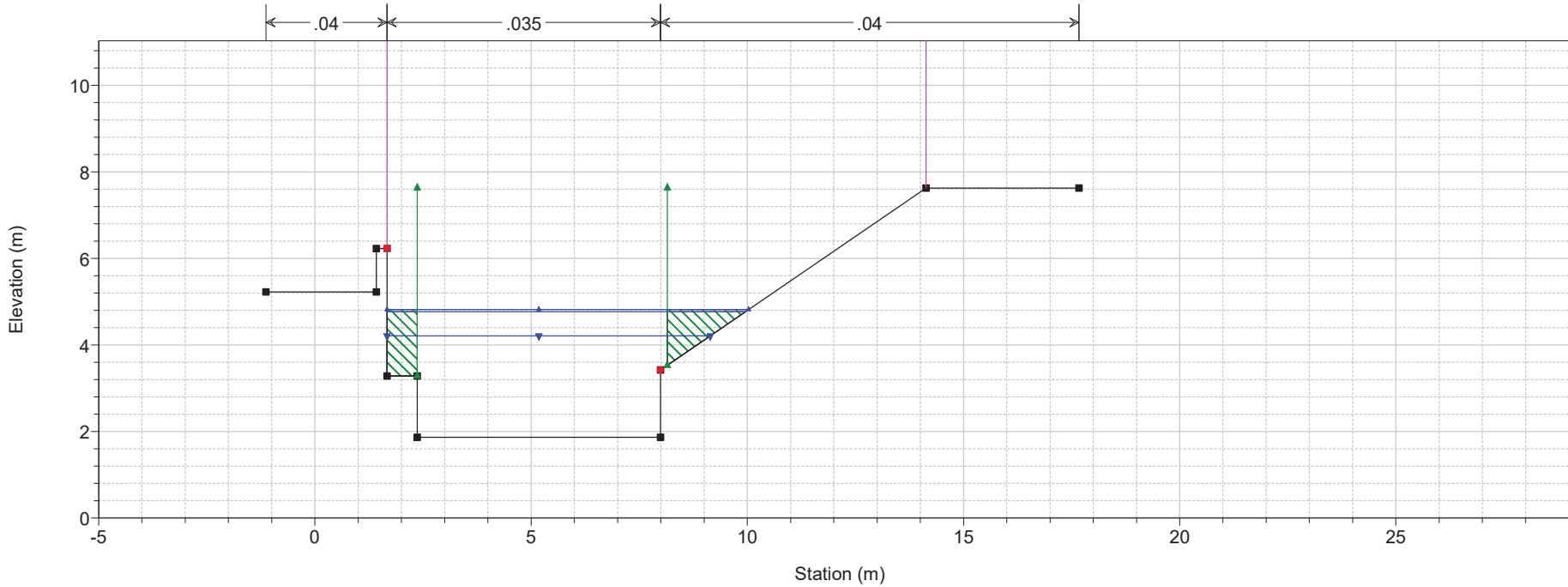

1 cm Horiz. = 1.5 m 1 cm Vert. = 1.5 m

1) A TR 200 1.5h 2) A TR 200 3h 3) A TR 30 1.5h

River = Iurco Reach = Iurco_valle RS = 7.5 BR

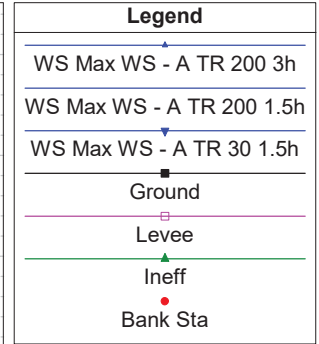
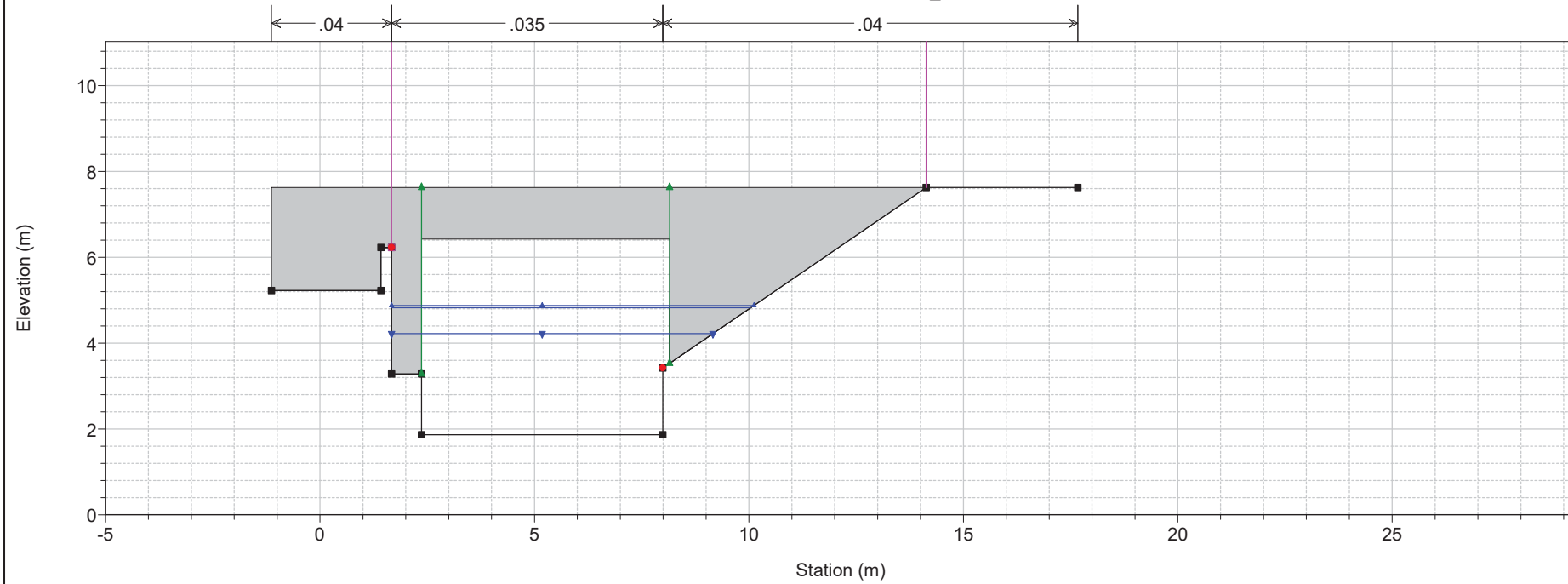

1) A TR 200 1.5h 2) A TR 200 3h 3) A TR 30 1.5h

River = Iurco Reach = Iurco_valle RS = 7.5 BR

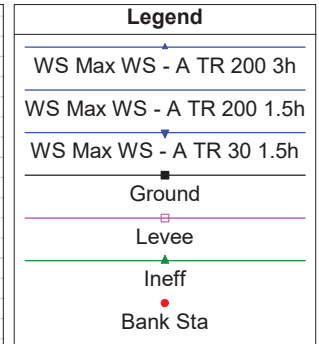
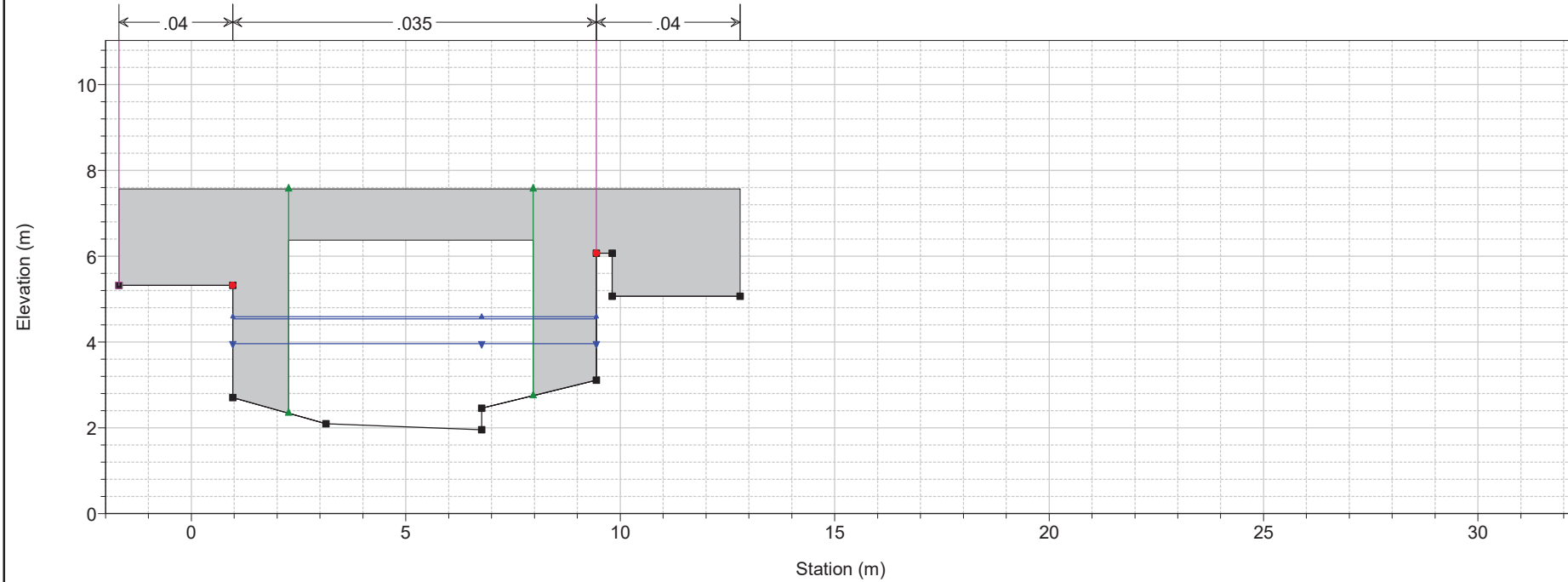

1 cm Horiz. = 1.5 m 1 cm Vert. = 1.5 m

1) A TR 200 1.5h 2) A TR 200 3h 3) A TR 30 1.5h

River = lurco Reach = lurco_valle RS = 7 Sez. 12

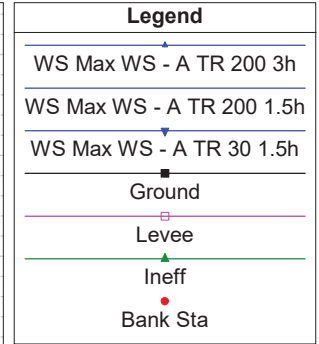
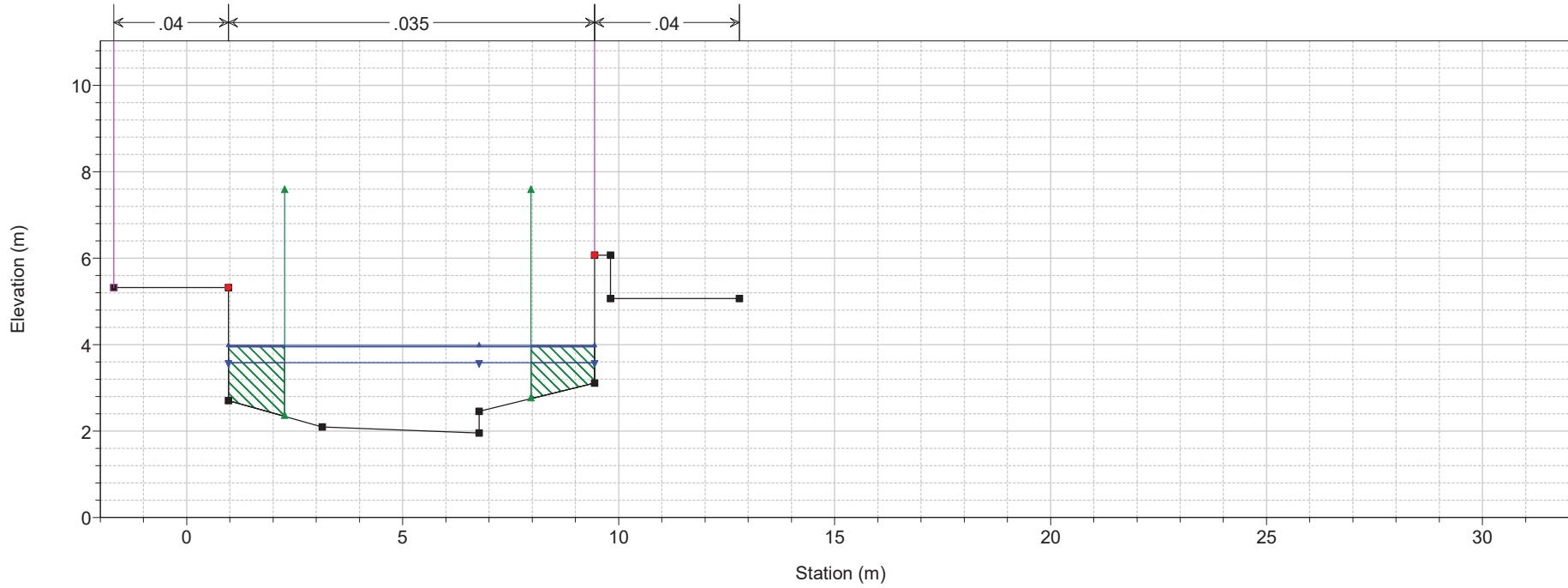

1) A TR 200 1.5h 2) A TR 200 3h 3) A TR 30 1.5h

River = lurco Reach = lurco_valle RS = 6 Sez. 13

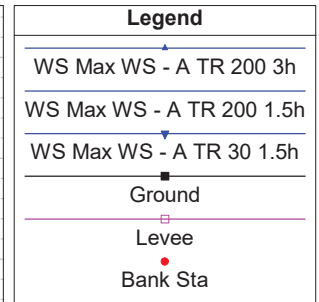
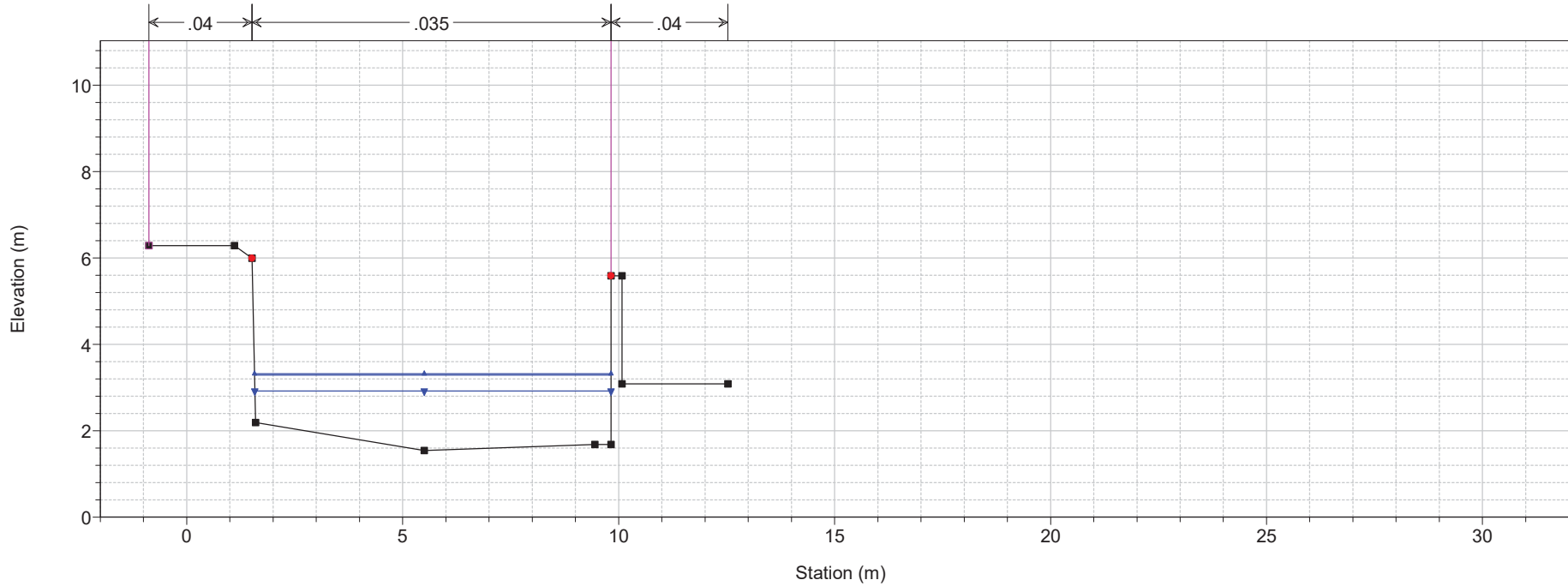

1) A TR 200 1.5h 2) A TR 200 3h 3) A TR 30 1.5h

River = Iurco Reach = Iurco_valle RS = 5 Sez. 14

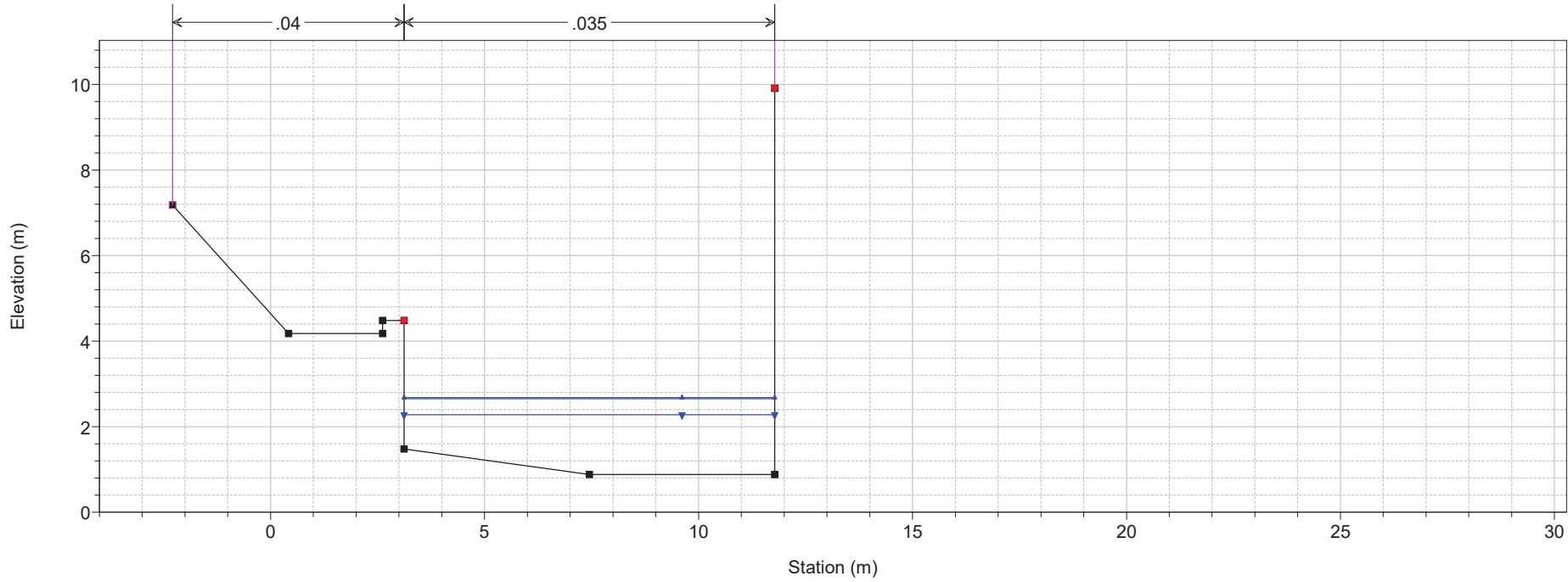

1) A TR 200 1.5h 2) A TR 200 3h 3) A TR 30 1.5h

River = Iurco Reach = Iurco_valle RS = 4.5 BR

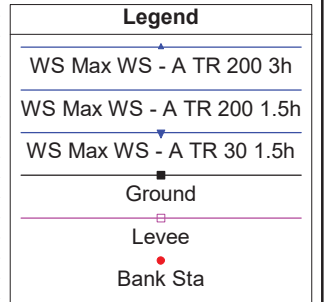
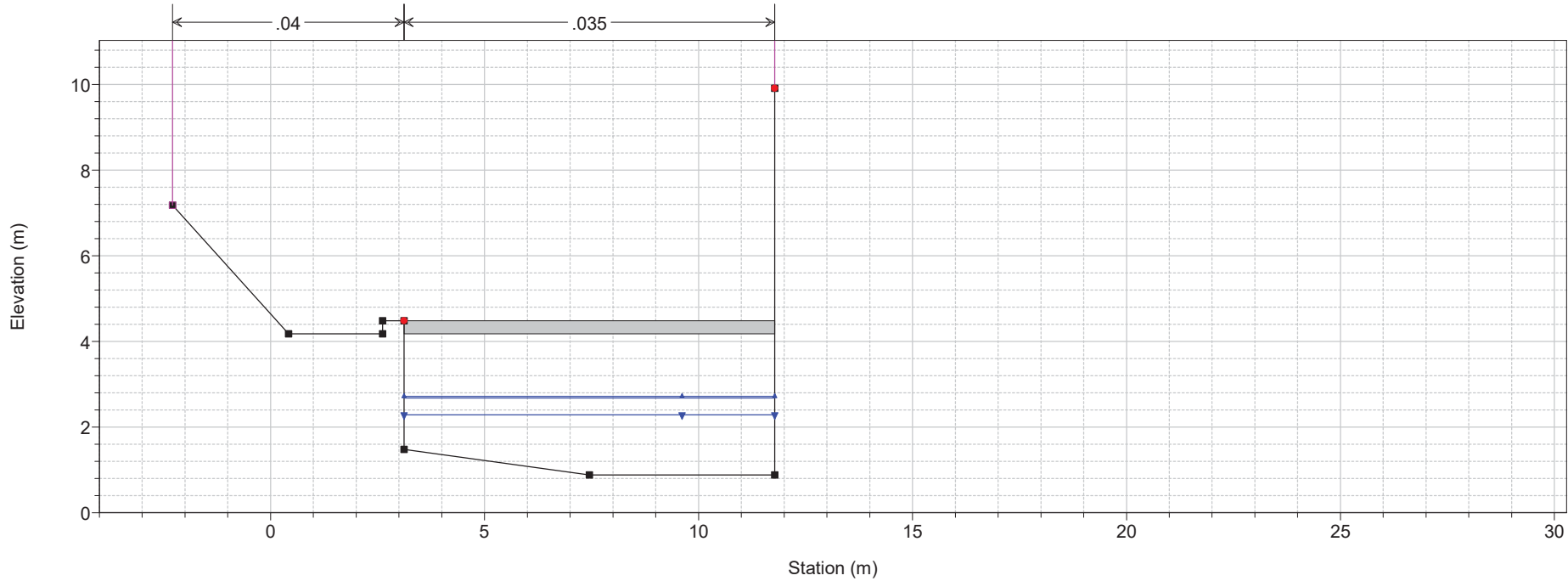

1 cm Horiz. = 1.5 m 1 cm Vert. = 1.5 m

1) A TR 200 1.5h 2) A TR 200 3h 3) A TR 30 1.5h

River = lurco Reach = lurco_valle RS = 4.5 BR

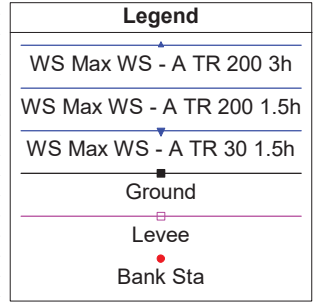
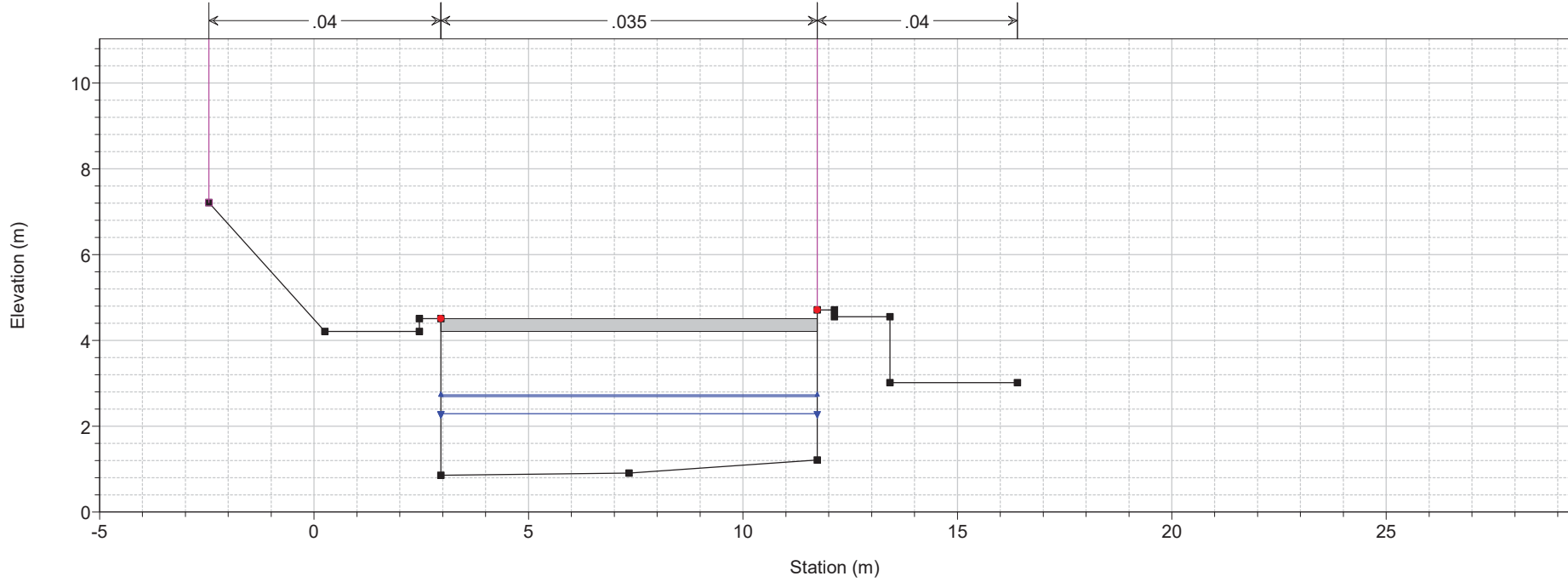

1) A TR 200 1.5h 2) A TR 200 3h 3) A TR 30 1.5h

River = lurco Reach = lurco_valle RS = 4 Sez. 15

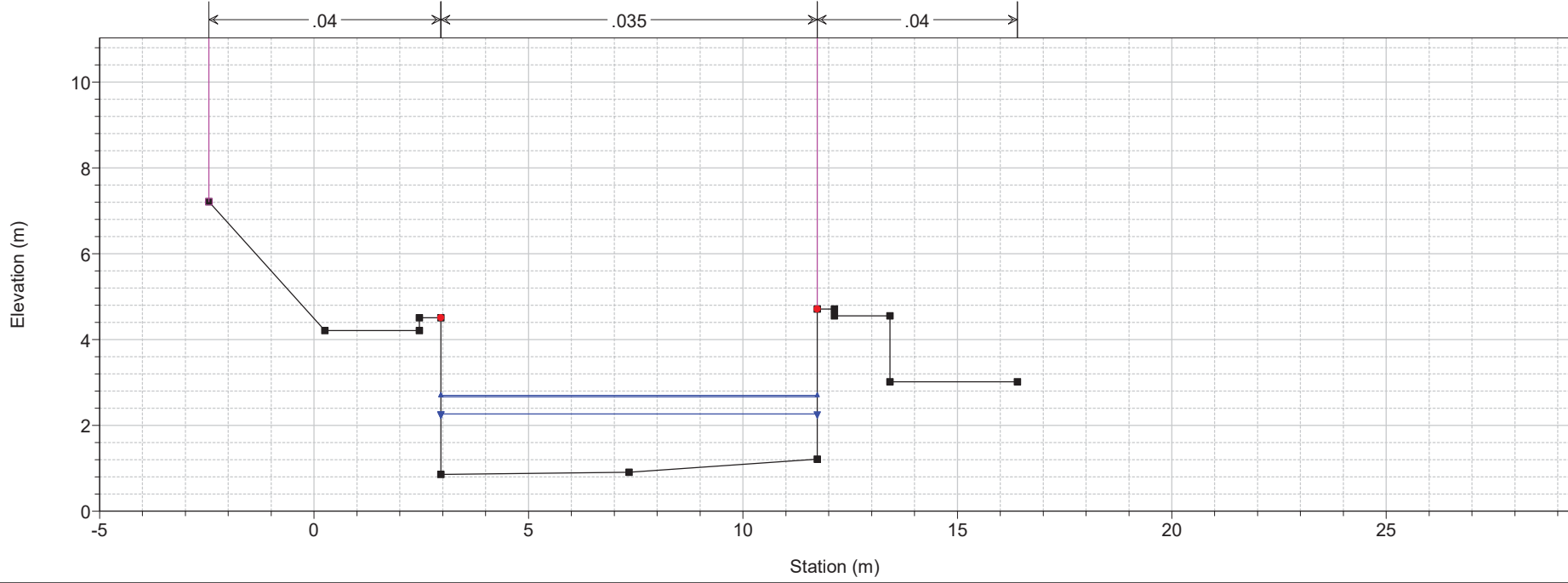

1 cm Horiz. = 1.5 m 1 cm Vert. = 1.5 m

1) A TR 200 1.5h 2) A TR 200 3h 3) A TR 30 1.5h

River = lurco Reach = lurco_valle RS = 3 Sez. 16

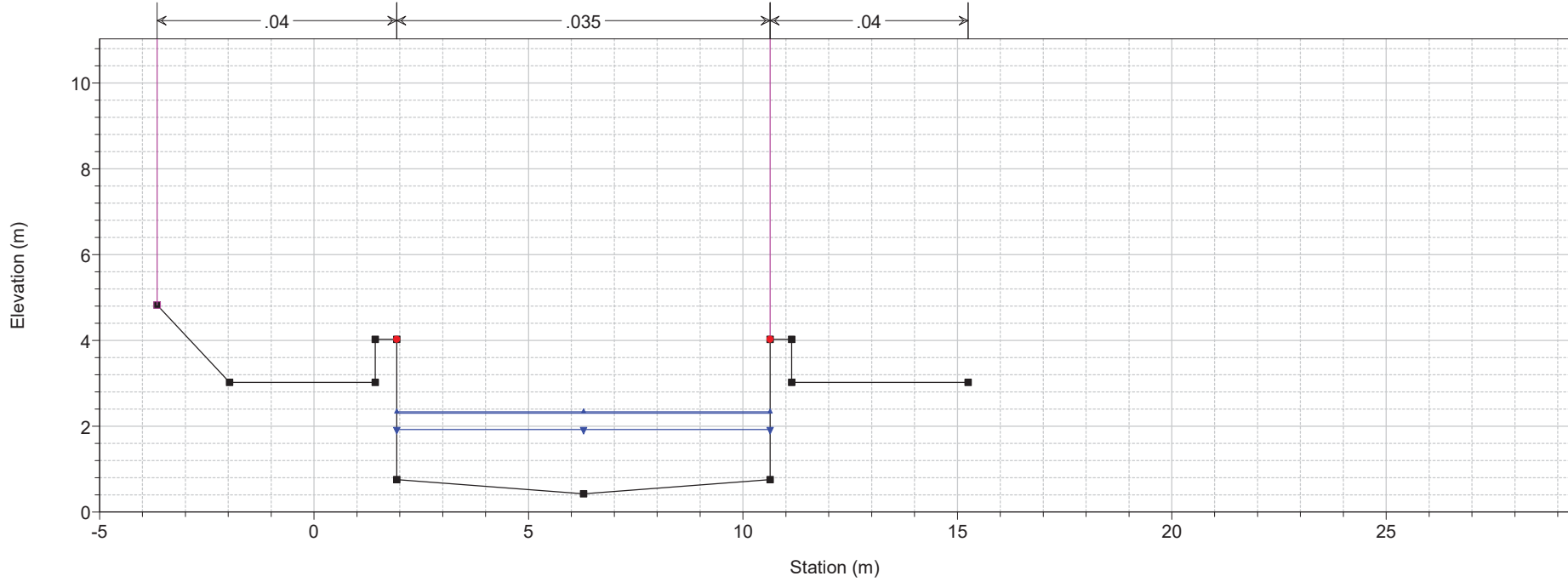

1) A TR 200 1.5h 2) A TR 200 3h 3) A TR 30 1.5h

River = lurco Reach = lurco_valle RS = 2 Sez. 17

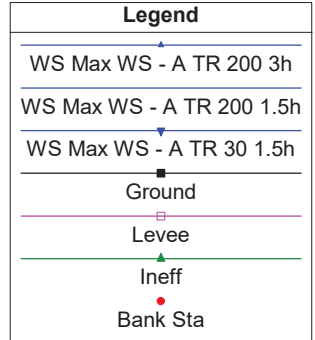
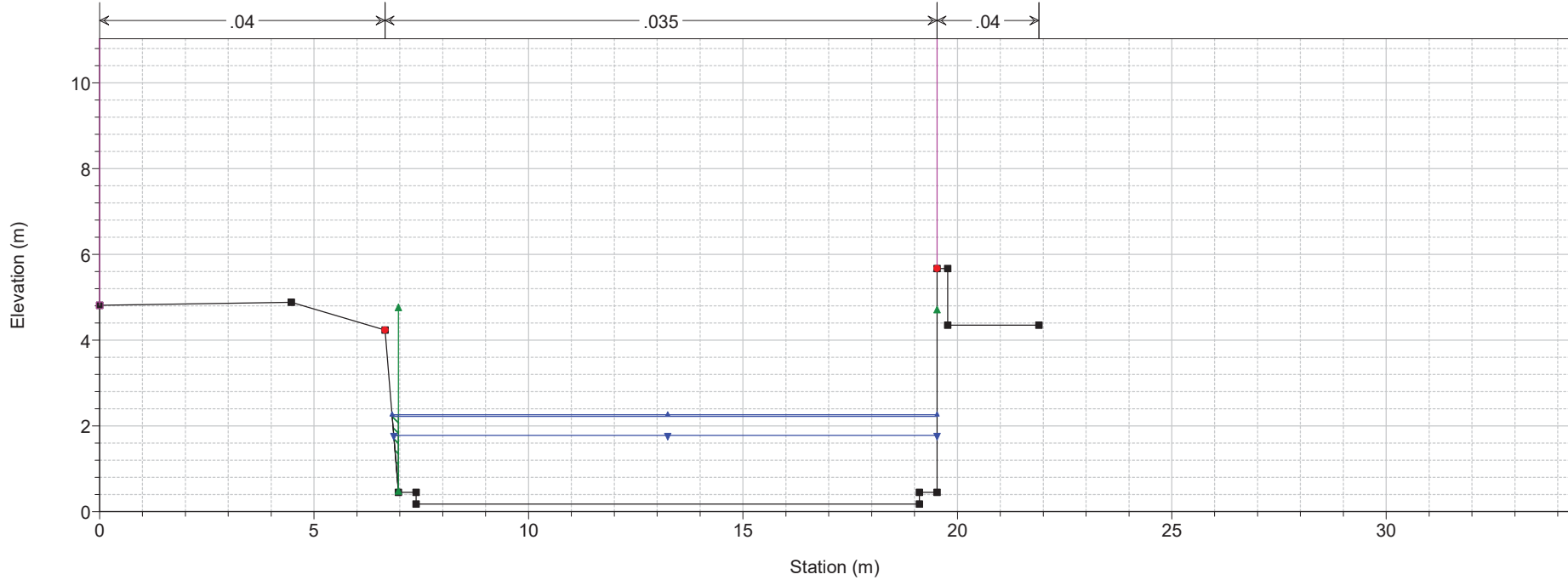

1 cm Horiz. = 1.5 m 1 cm Vert. = 1.5 m

1) A TR 200 1.5h 2) A TR 200 3h 3) A TR 30 1.5h

River = Iurco Reach = Iurco_valle RS = 1.5 BR

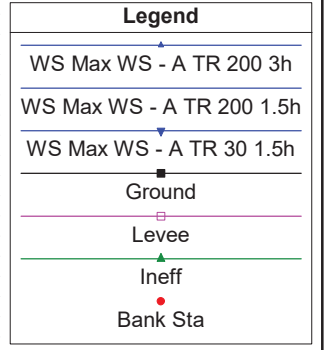
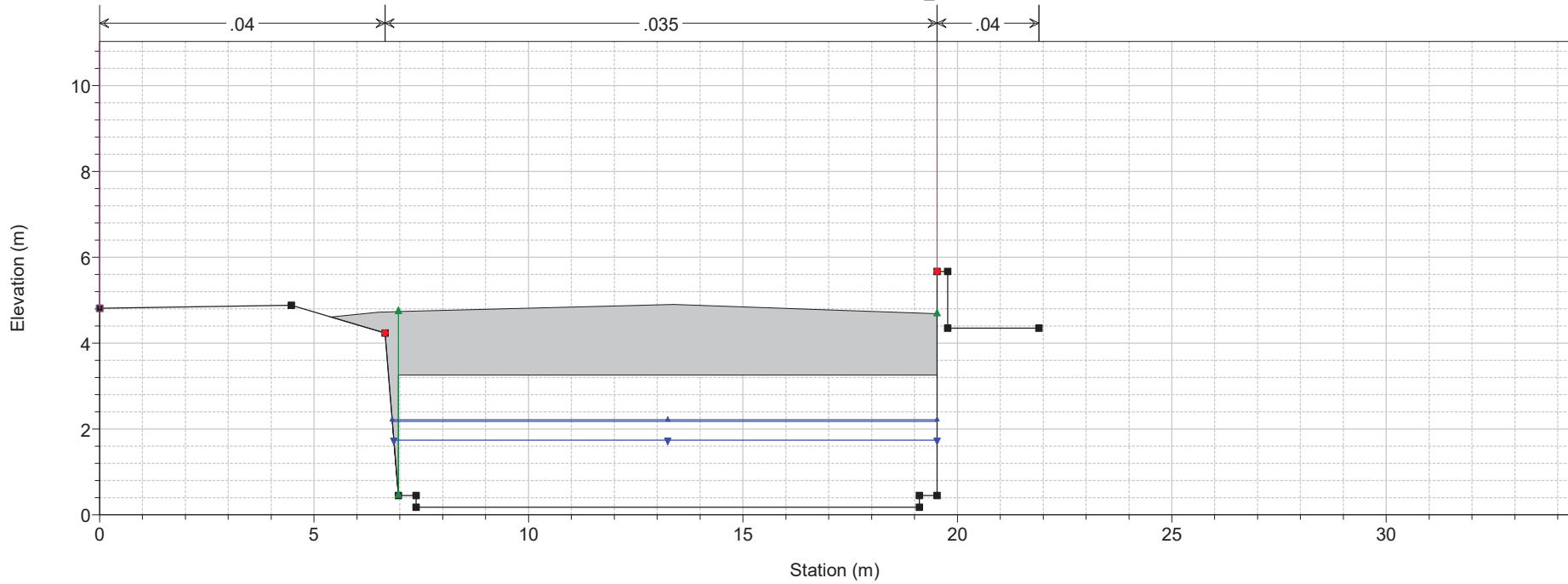

1) A TR 200 1.5h 2) A TR 200 3h 3) A TR 30 1.5h

River = Iurco Reach = Iurco_valle RS = 1.5 BR

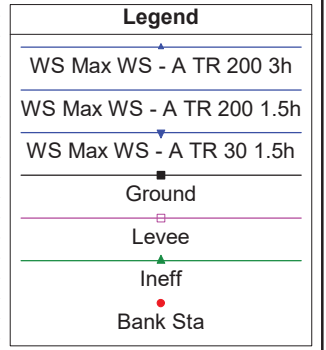
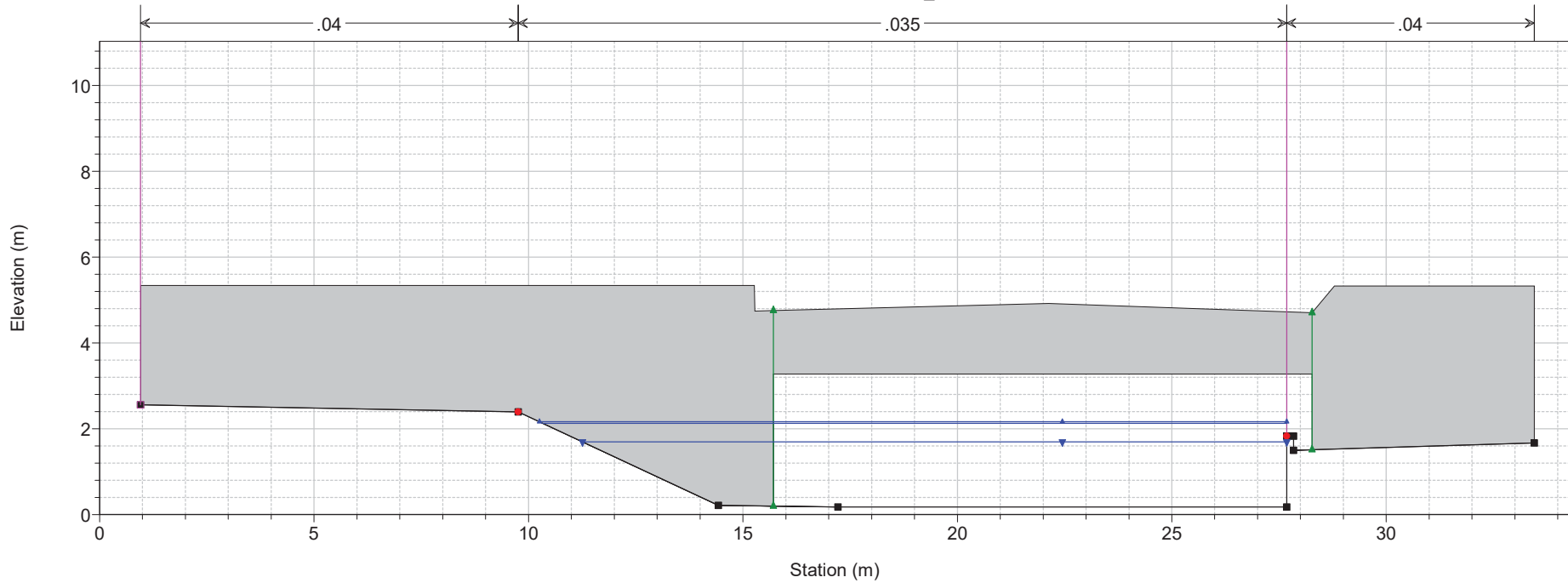

1) A TR 200 1.5h 2) A TR 200 3h 3) A TR 30 1.5h
 River = lurco Reach = lurco_valle RS = 1.1 Sez. 18

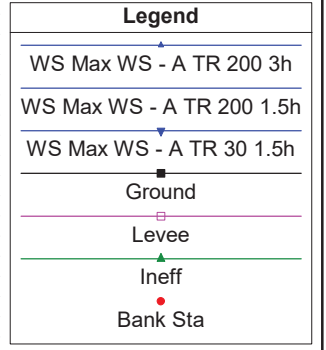
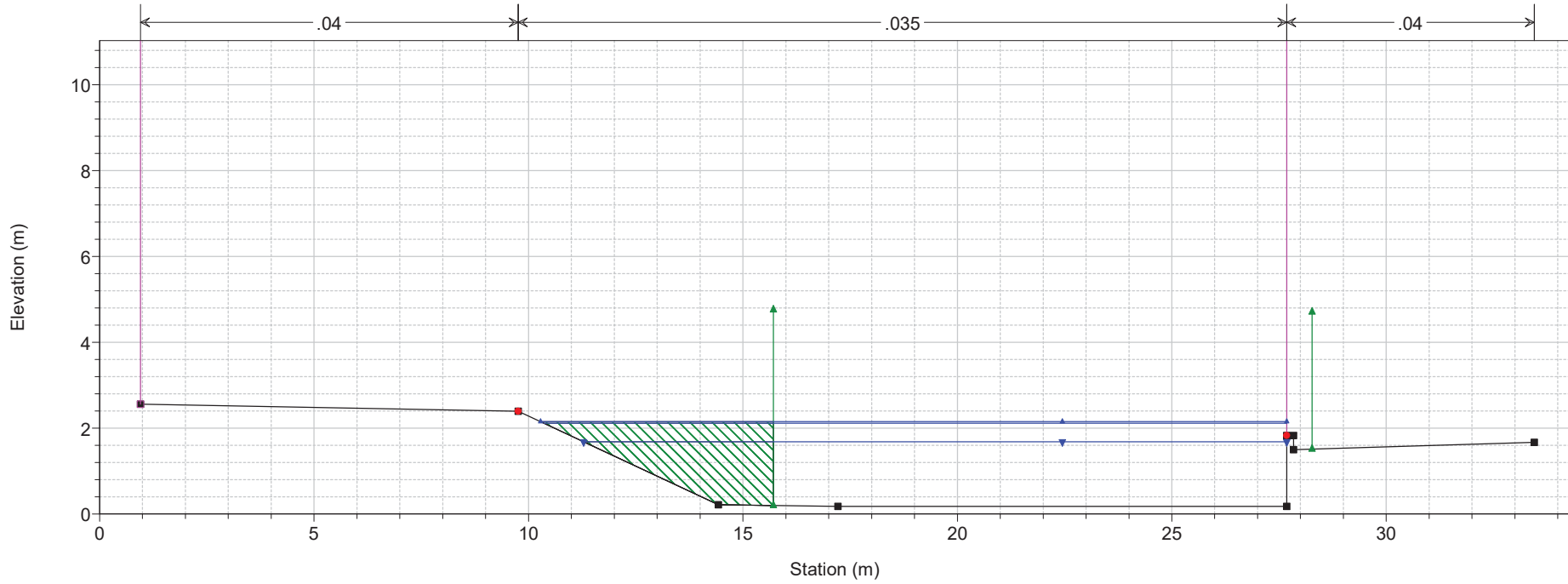

1) A TR 200 1.5h 2) A TR 200 3h 3) A TR 30 1.5h
 River = lurco Reach = lurco_valle RS = 1 Sez. 18

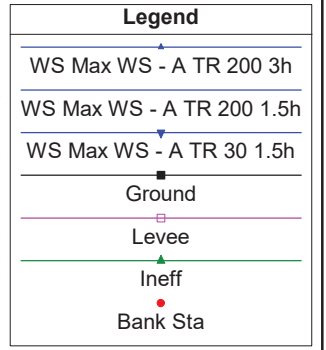
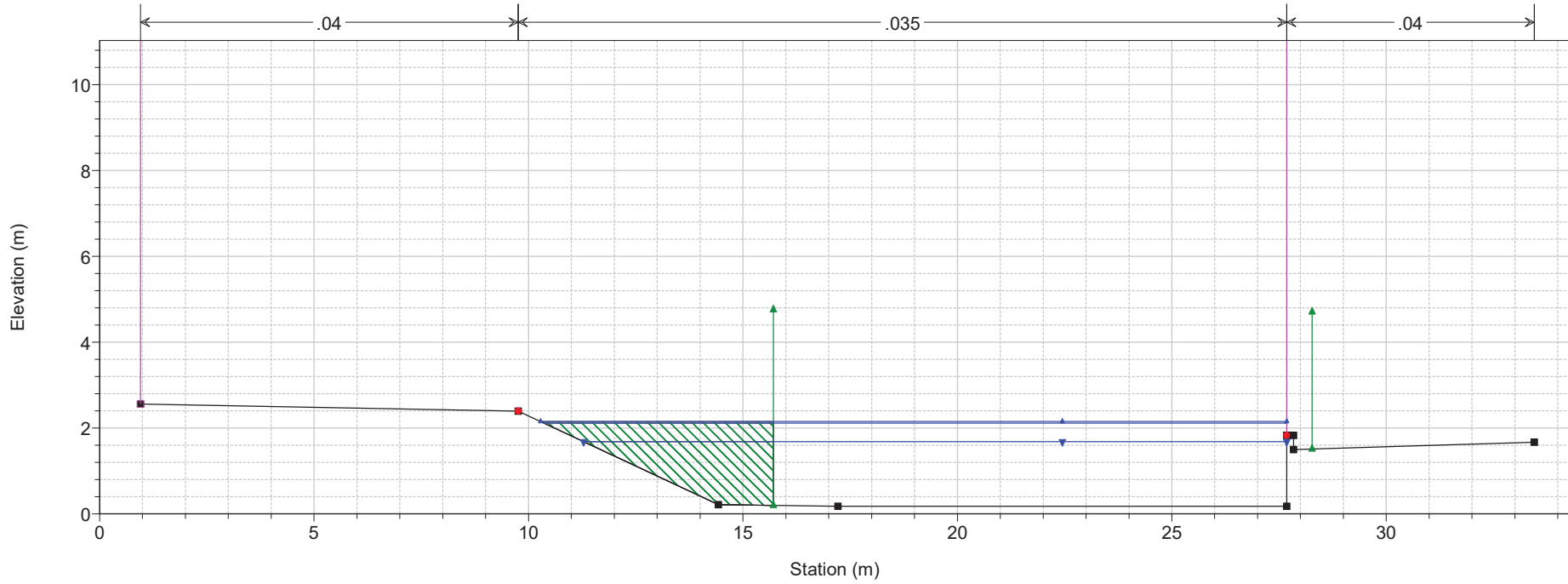

1 cm Horiz. = 1.5 m 1 cm Vert. = 1.5 m

1) A TR 200 1.5h 2) A TR 200 3h 3) A TR 30 1.5h

River = Crocetta Reach = Crocetta RS = 15 Sez. 15c

← .04 → .035 ← .04 →

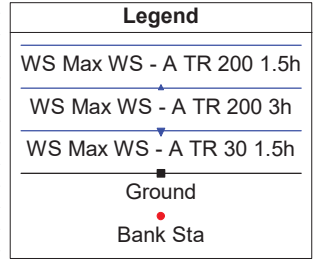
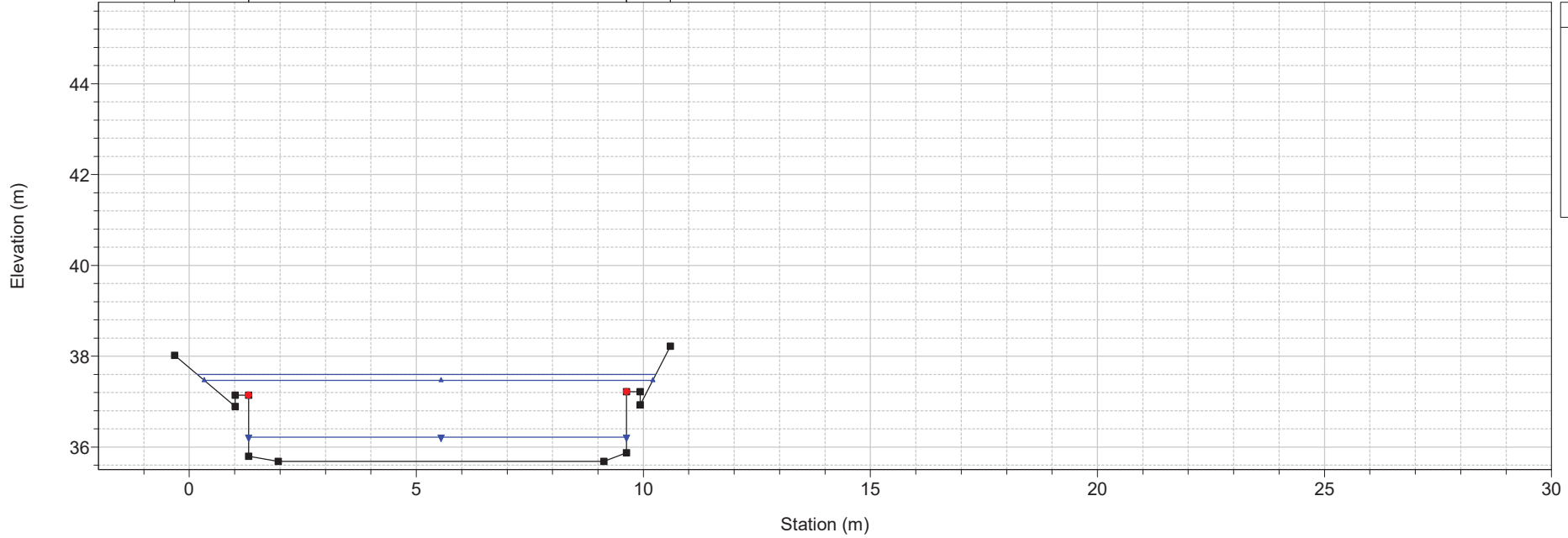

1) A TR 200 1.5h 2) A TR 200 3h 3) A TR 30 1.5h

River = Crocetta Reach = Crocetta RS = 14 Sez. 14c

← .04 → .035 ← .04 →

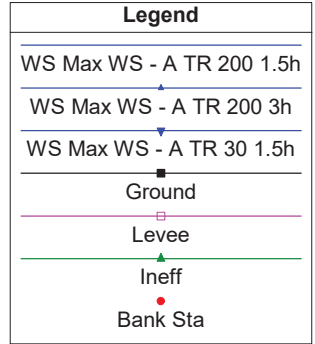
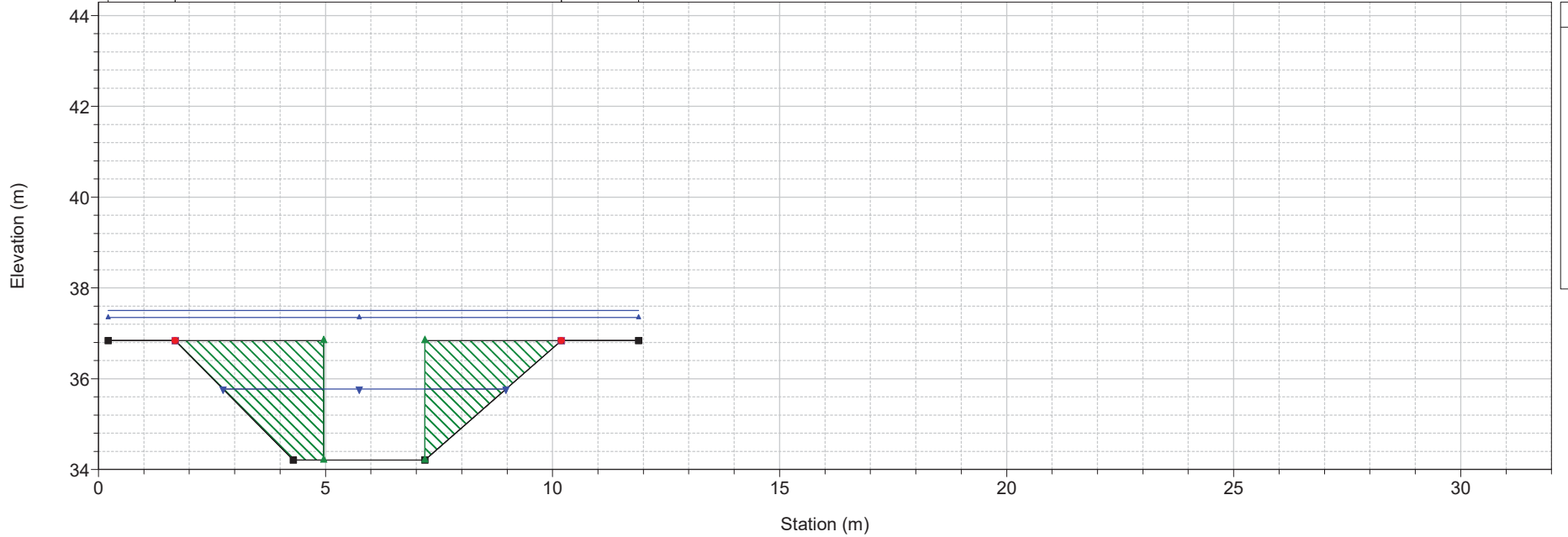

1) A TR 200 1.5h 2) A TR 200 3h 3) A TR 30 1.5h
 River = Crocetta Reach = Crocetta RS = 13.5 BR

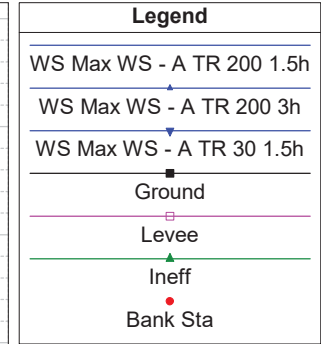
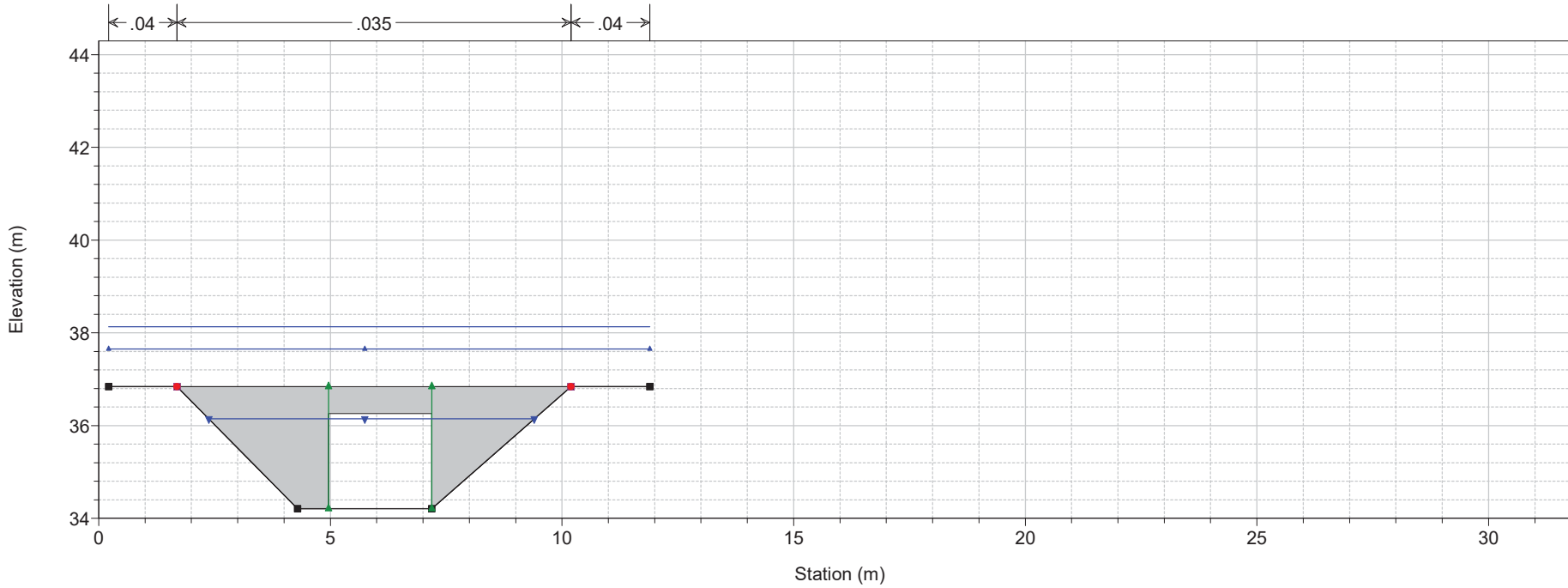

1) A TR 200 1.5h 2) A TR 200 3h 3) A TR 30 1.5h
 River = Crocetta Reach = Crocetta RS = 13.5 BR

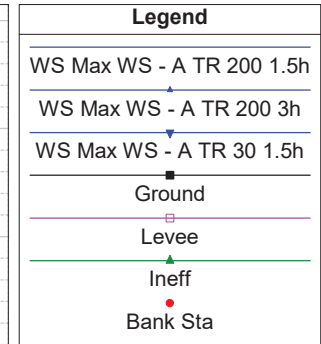
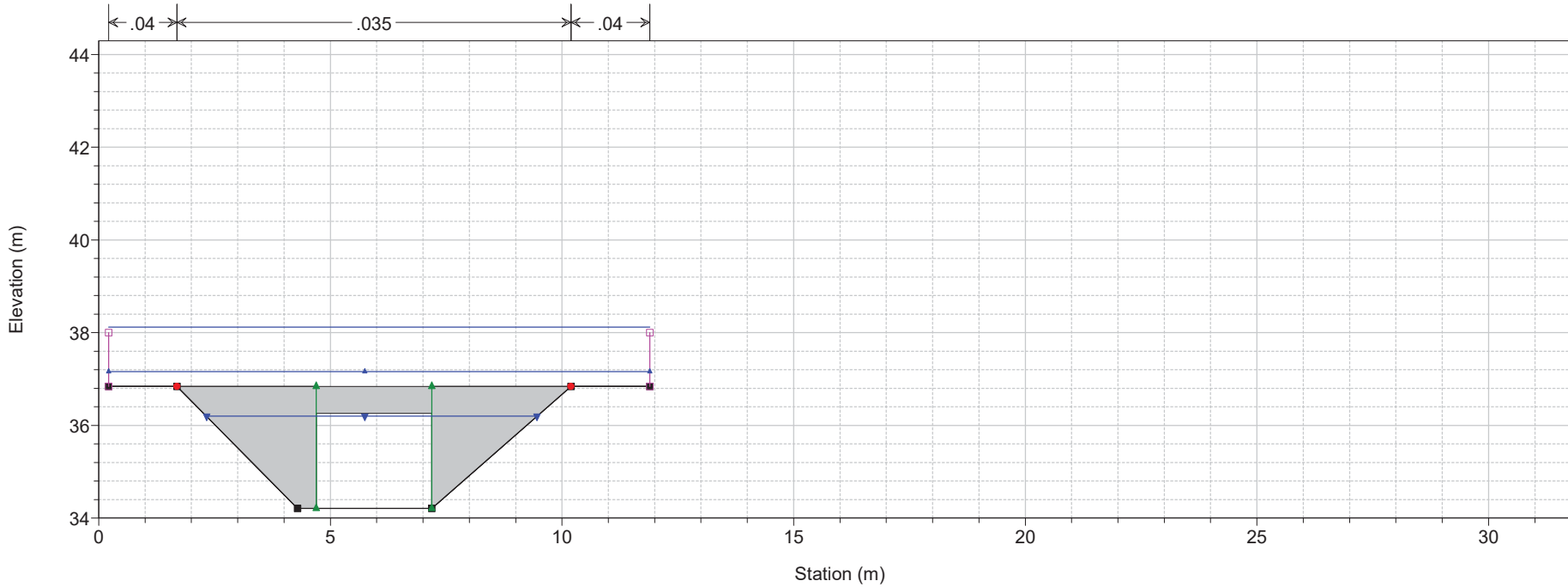

1) A TR 200 1.5h 2) A TR 200 3h 3) A TR 30 1.5h
 River = Crocetta Reach = Crocetta RS = 13 Sez. 13c

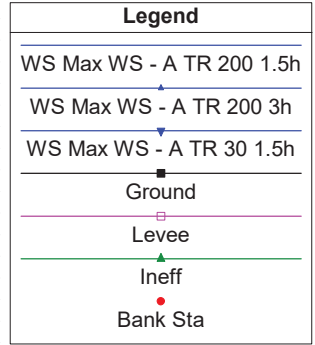
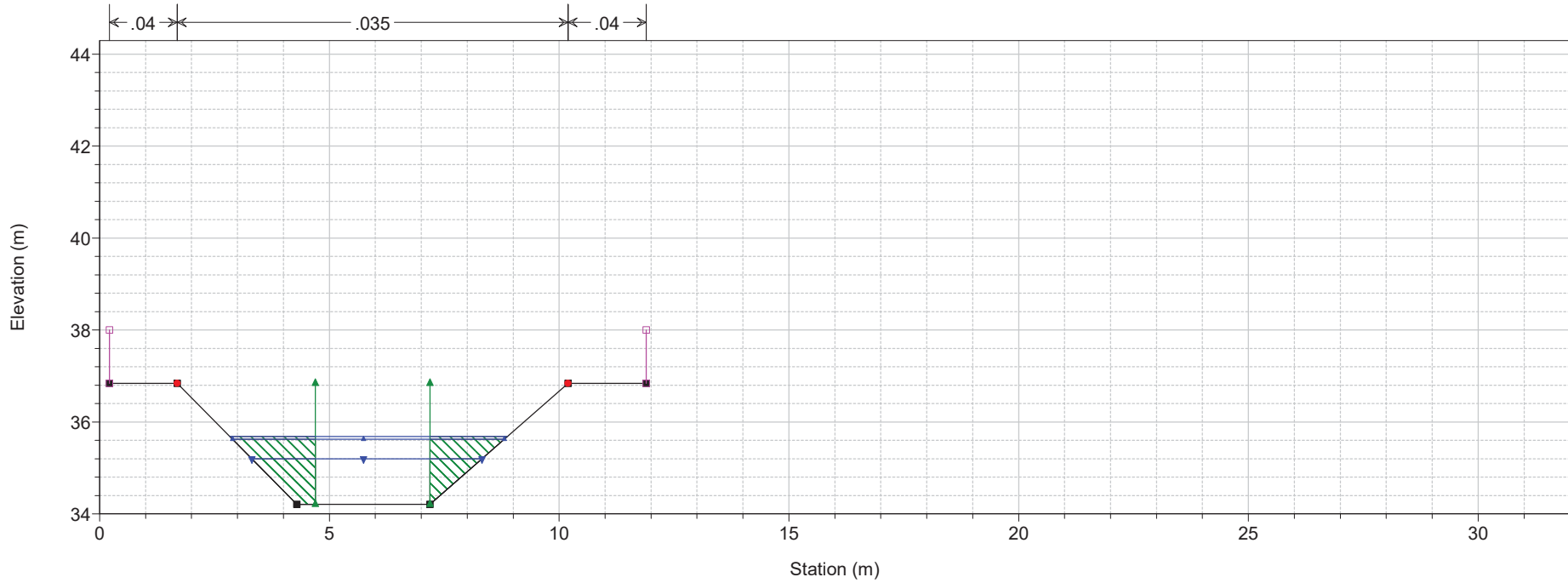

1) A TR 200 1.5h 2) A TR 200 3h 3) A TR 30 1.5h
 River = Crocetta Reach = Crocetta RS = 12 Sez. 12c

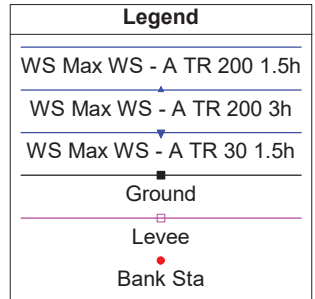
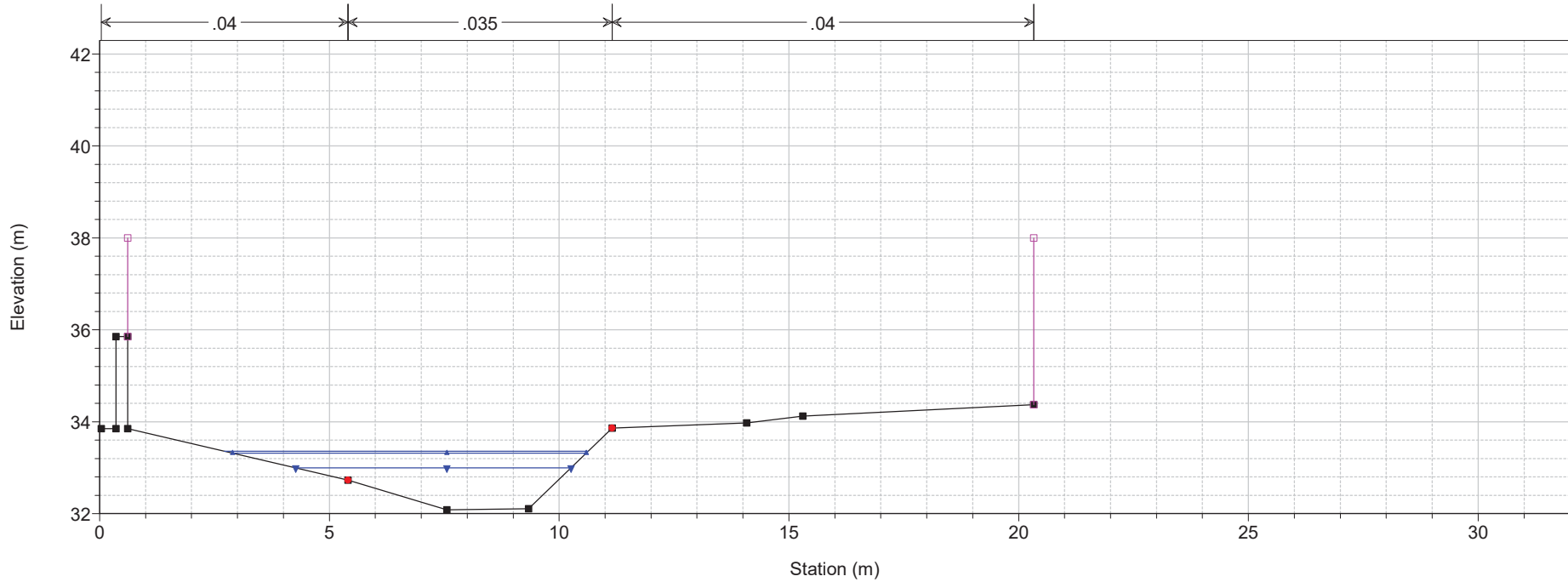

1) A TR 200 1.5h 2) A TR 200 3h 3) A TR 30 1.5h

River = Crocetta Reach = Crocetta RS = 11 Sez. 11c

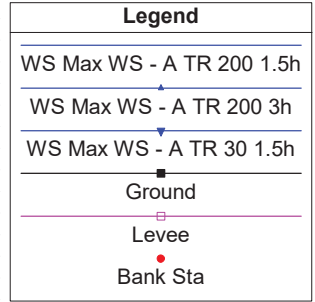
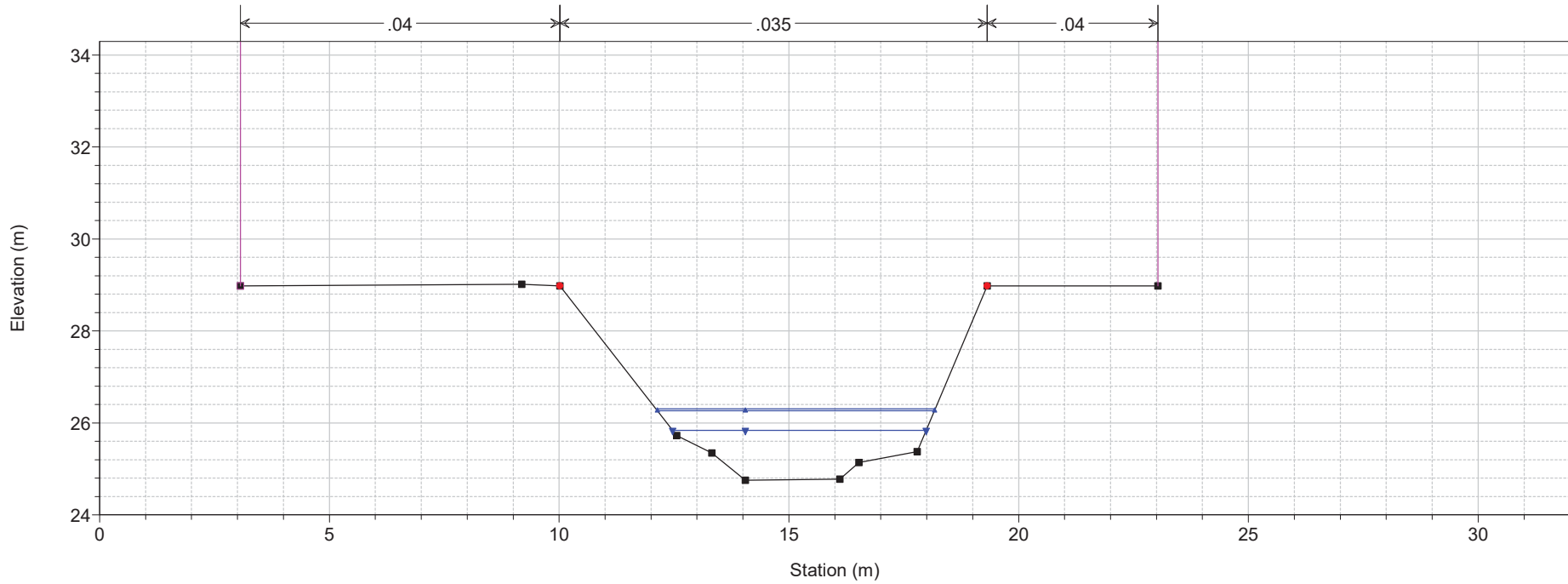

1) A TR 200 1.5h 2) A TR 200 3h 3) A TR 30 1.5h

River = Crocetta Reach = Crocetta RS = 10 Sez. 10c

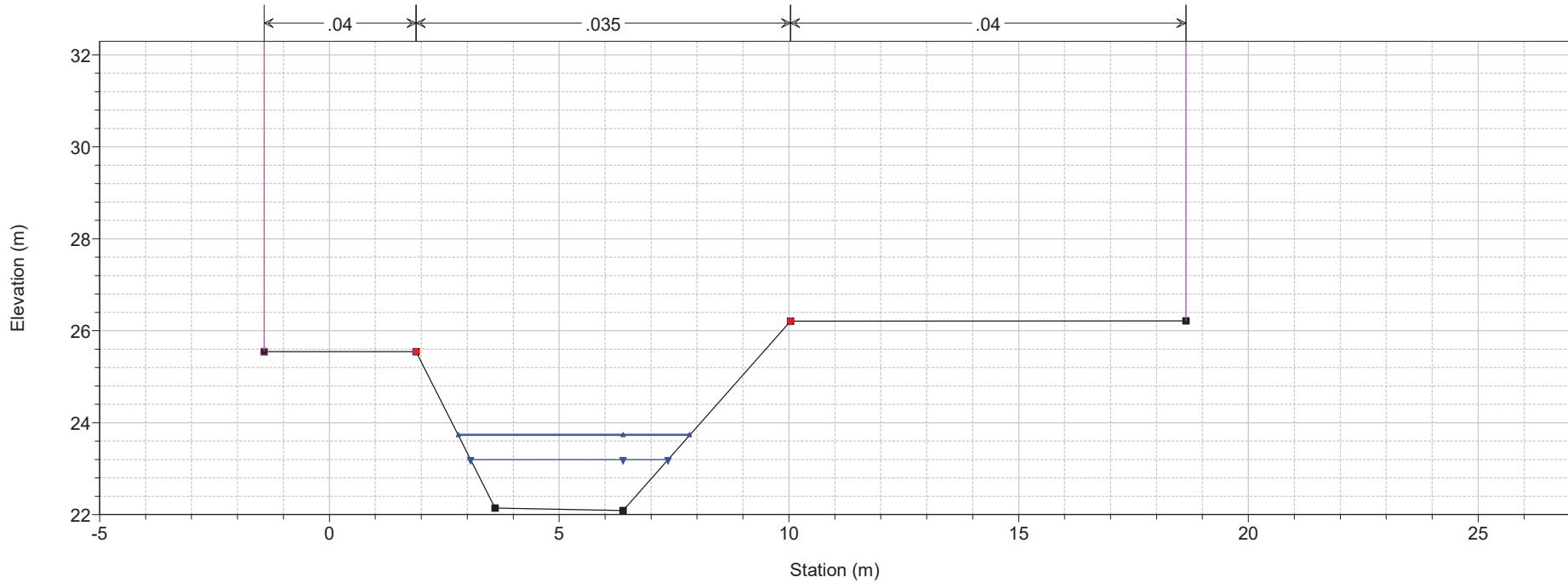

1) A TR 200 1.5h 2) A TR 200 3h 3) A TR 30 1.5h

River = Crocetta Reach = Crocetta RS = 9 Sez. 9c

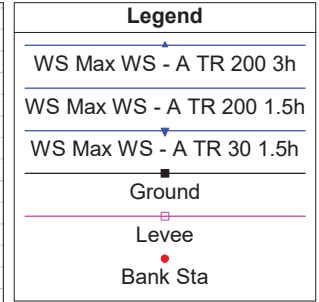
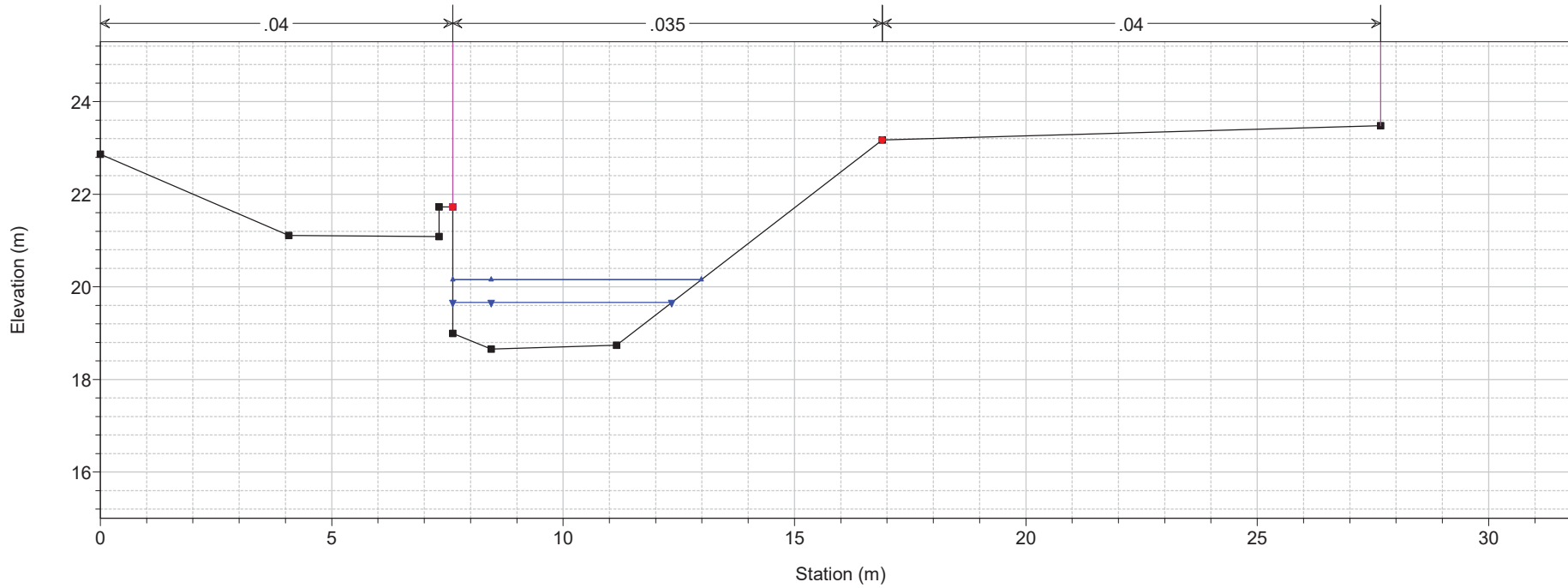

1) A TR 200 1.5h 2) A TR 200 3h 3) A TR 30 1.5h

River = Crocetta Reach = Crocetta RS = 8 Sez. 8c

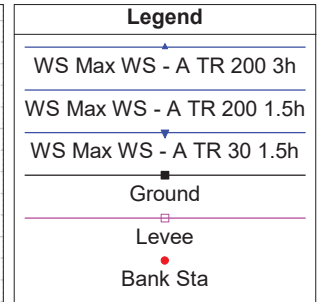
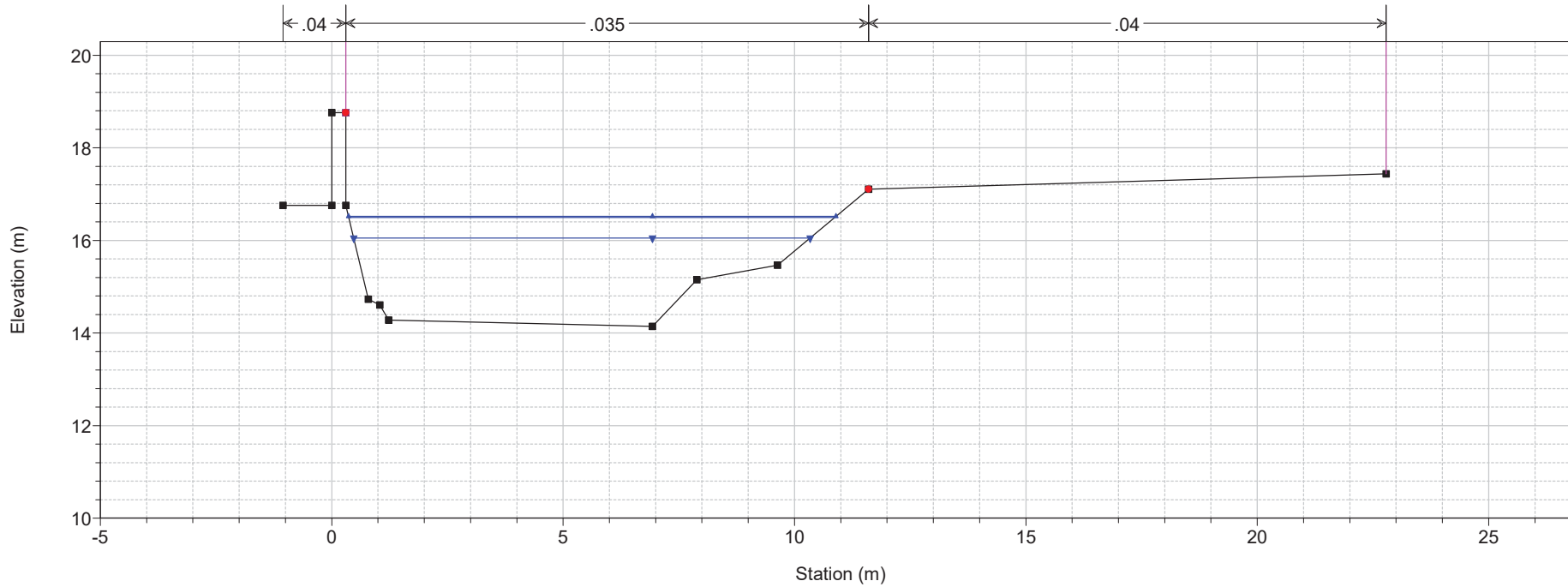

1) A TR 200 1.5h 2) A TR 200 3h 3) A TR 30 1.5h

River = Crocetta Reach = Crocetta RS = 7.95 IS

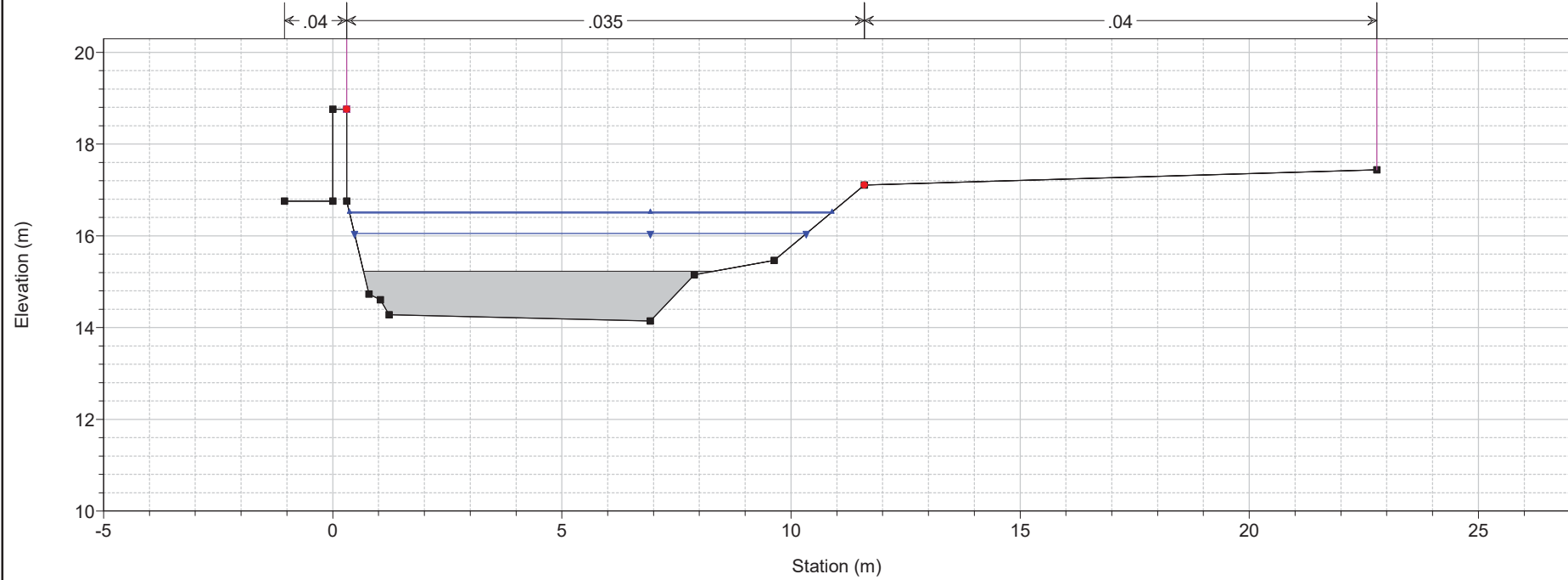

1) A TR 200 1.5h 2) A TR 200 3h 3) A TR 30 1.5h

River = Crocetta Reach = Crocetta RS = 7.9 Sez. 8c

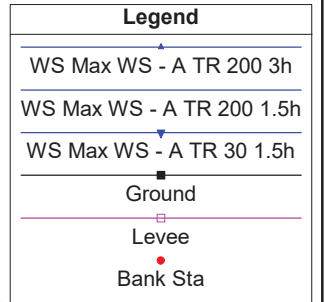
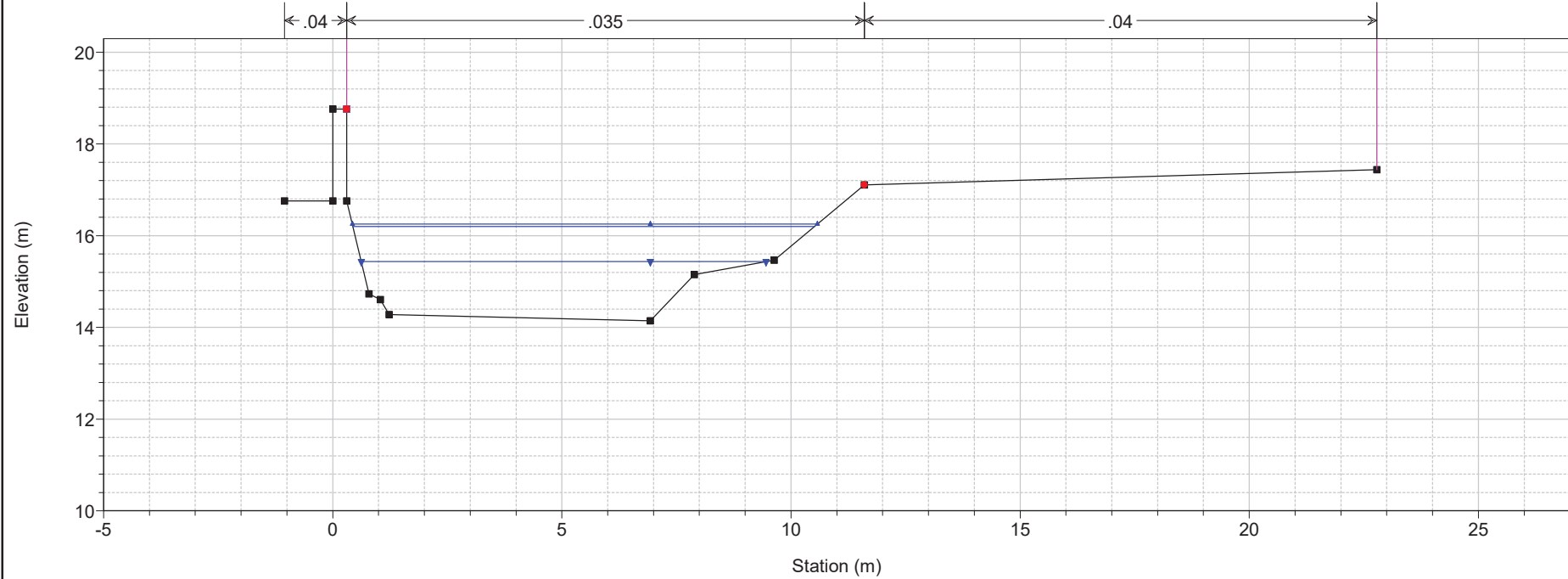

1) A TR 200 1.5h 2) A TR 200 3h 3) A TR 30 1.5h

River = Crocetta Reach = Crocetta RS = 7 Sez. 7c

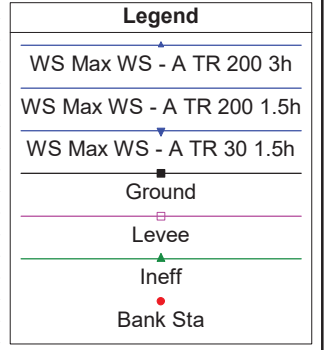
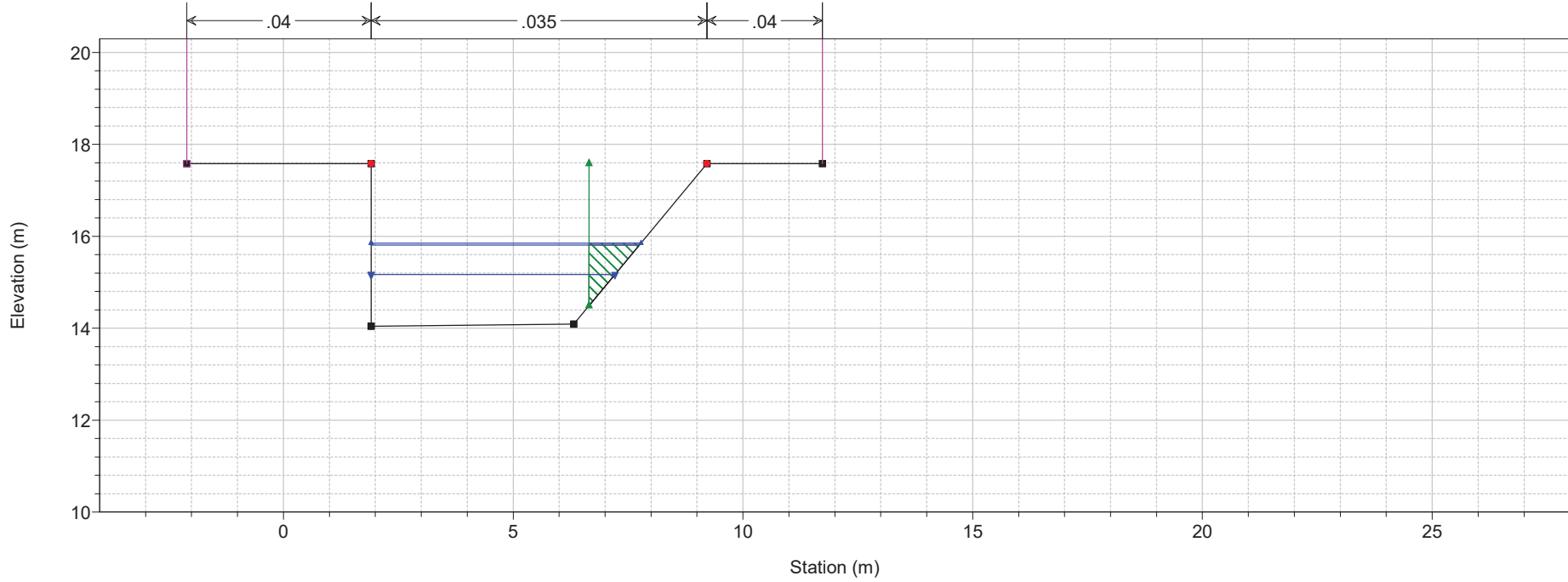

1) A TR 200 1.5h 2) A TR 200 3h 3) A TR 30 1.5h

River = Crocetta Reach = Crocetta RS = 6.5 BR

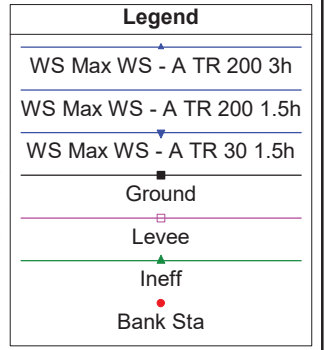
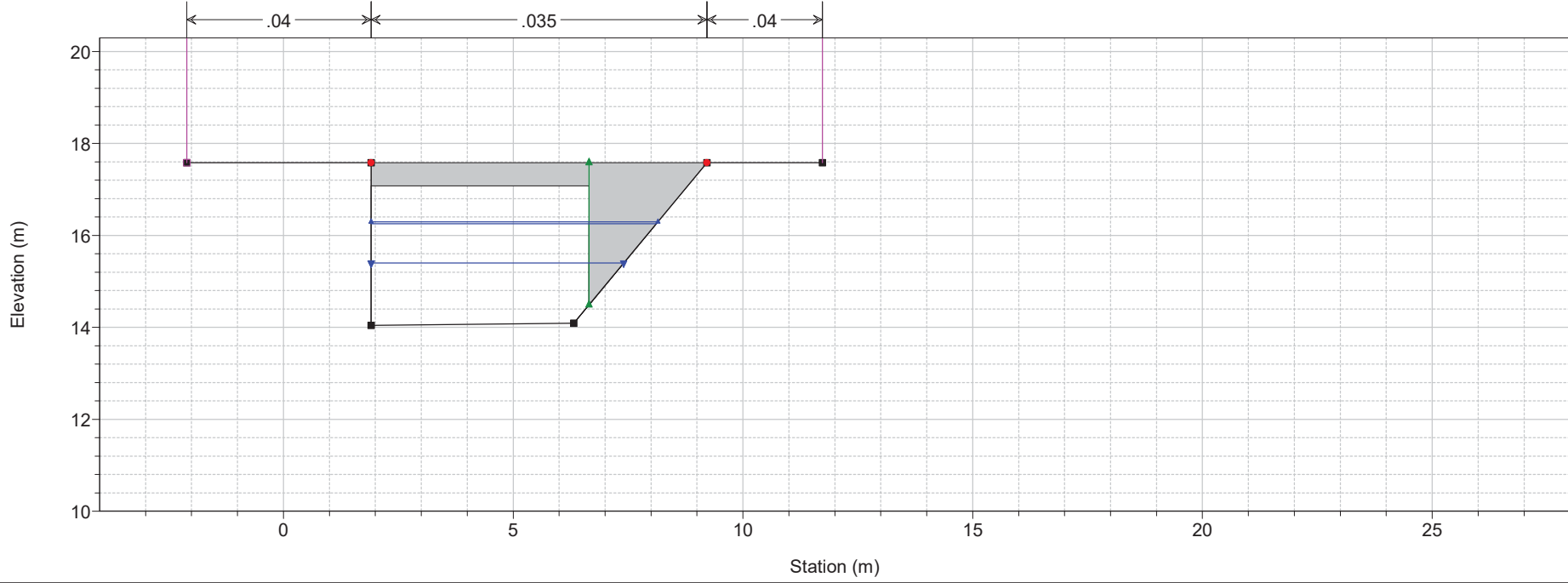

1 cm Horiz. = 1.4 m 1 cm Vert. = 1.4 m

1) A TR 200 1.5h 2) A TR 200 3h 3) A TR 30 1.5h

River = Crocetta Reach = Crocetta RS = 6.5 BR

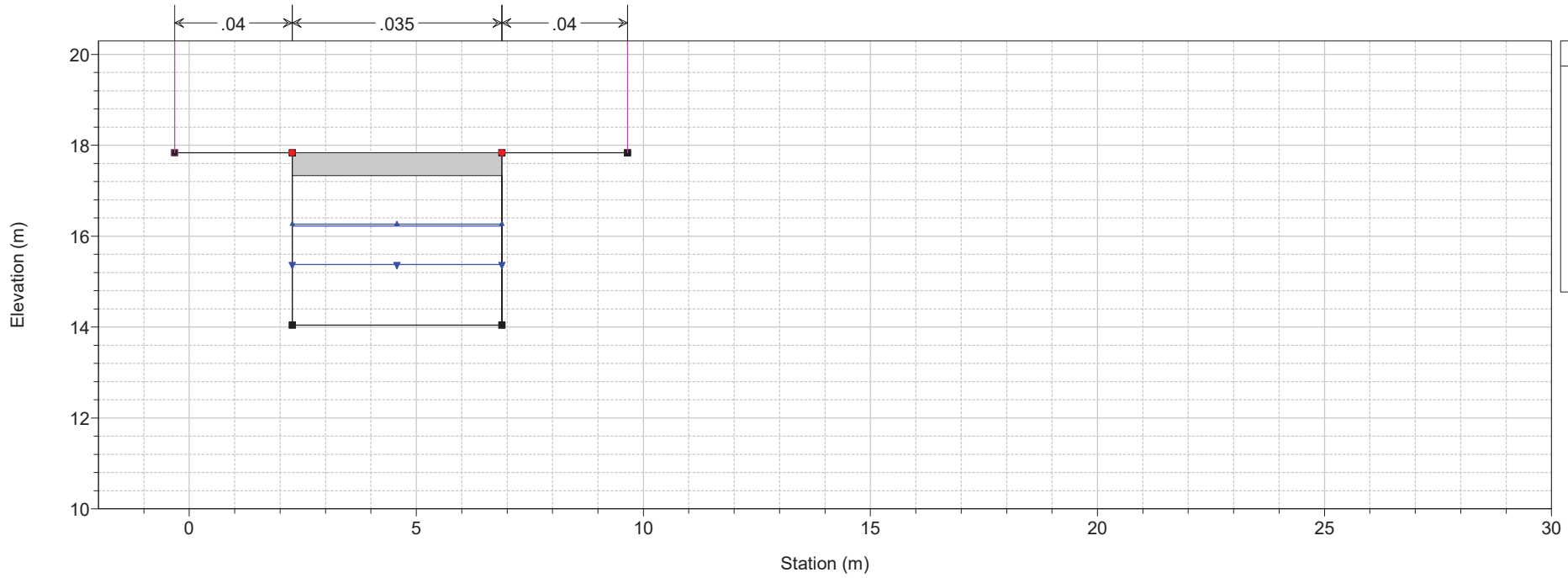

1) A TR 200 1.5h 2) A TR 200 3h 3) A TR 30 1.5h

River = Crocetta Reach = Crocetta RS = 6 Sez. 6c

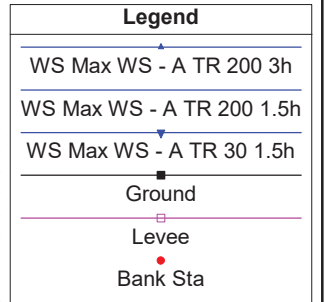
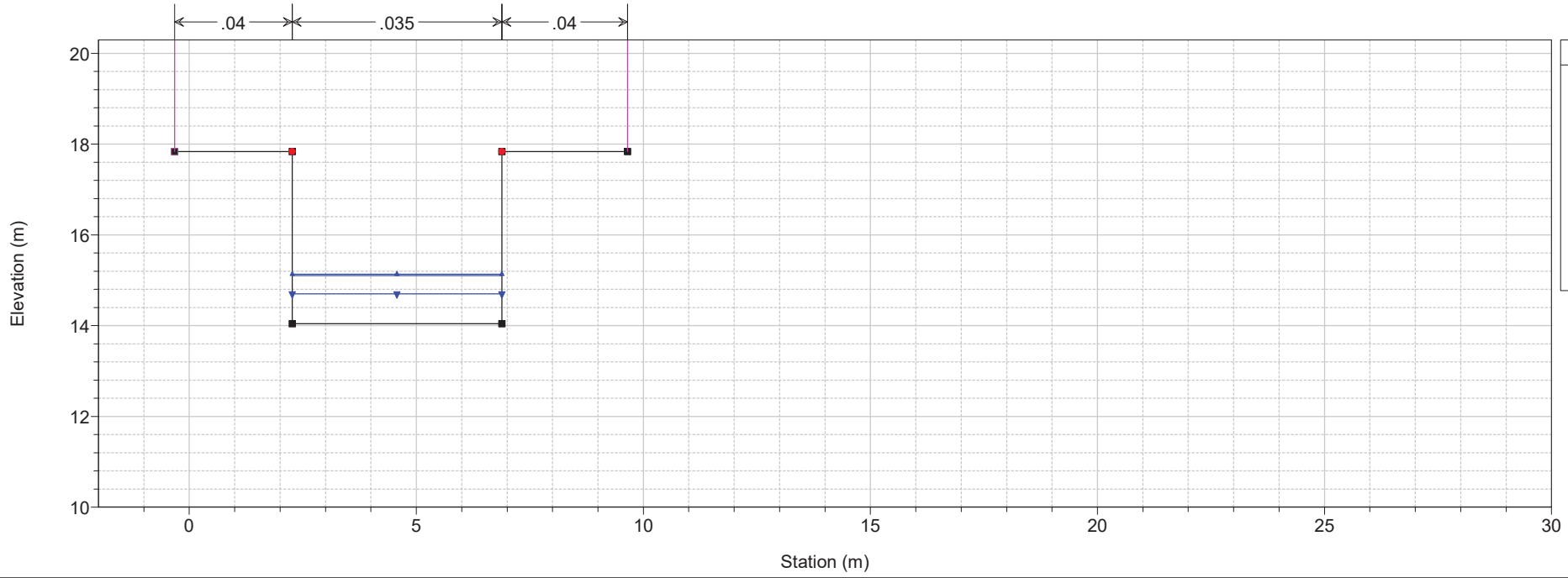

1 cm Horiz. = 1.4 m 1 cm Vert. = 1.4 m

1) A TR 200 1.5h 2) A TR 200 3h 3) A TR 30 1.5h

River = Crocetta Reach = Crocetta RS = 5 Sez. 5c

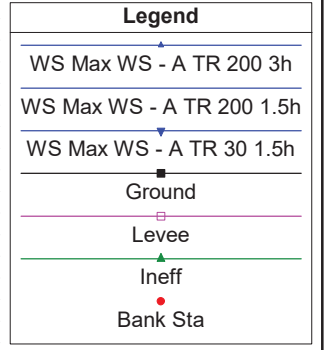
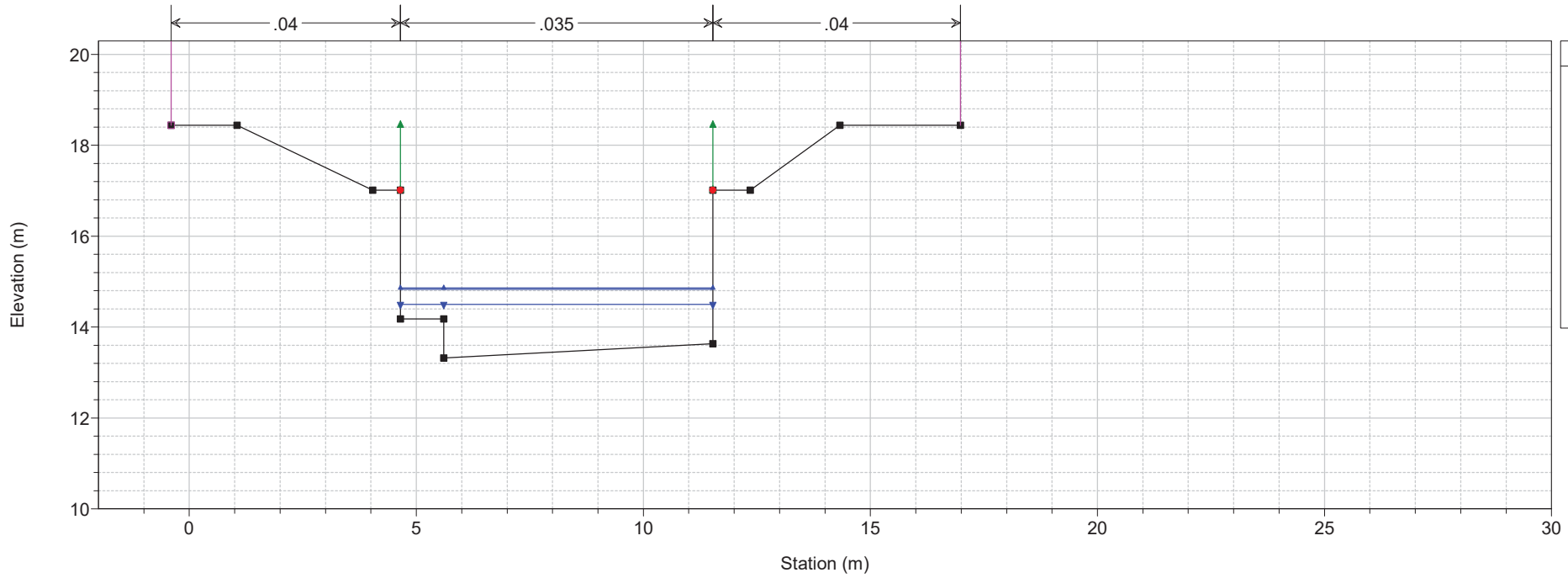

1) A TR 200 1.5h 2) A TR 200 3h 3) A TR 30 1.5h

River = Crocetta Reach = Crocetta RS = 4.5 BR

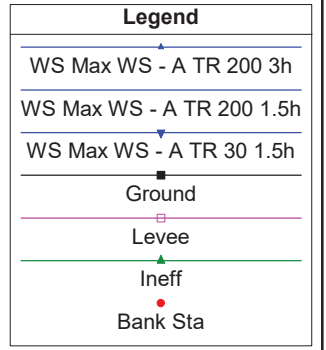
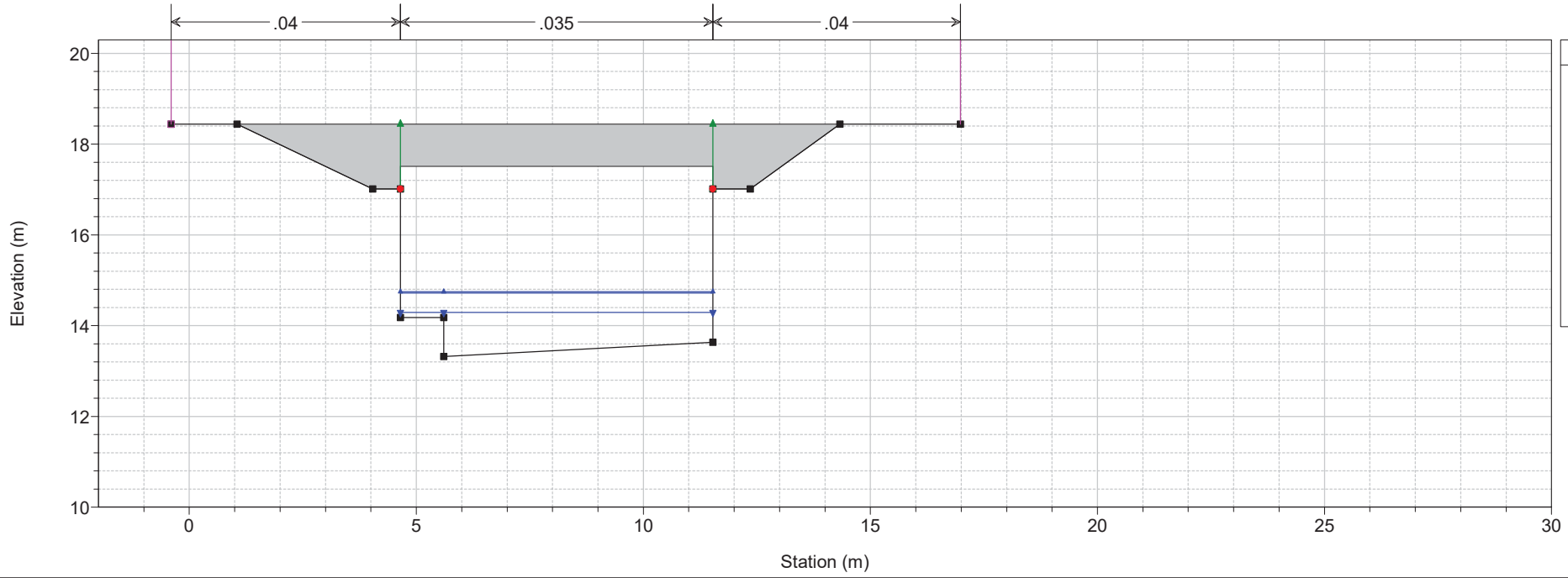

1) A TR 200 1.5h 2) A TR 200 3h 3) A TR 30 1.5h
 River = Crocetta Reach = Crocetta RS = 4.5 BR

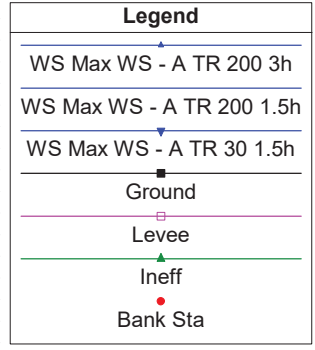
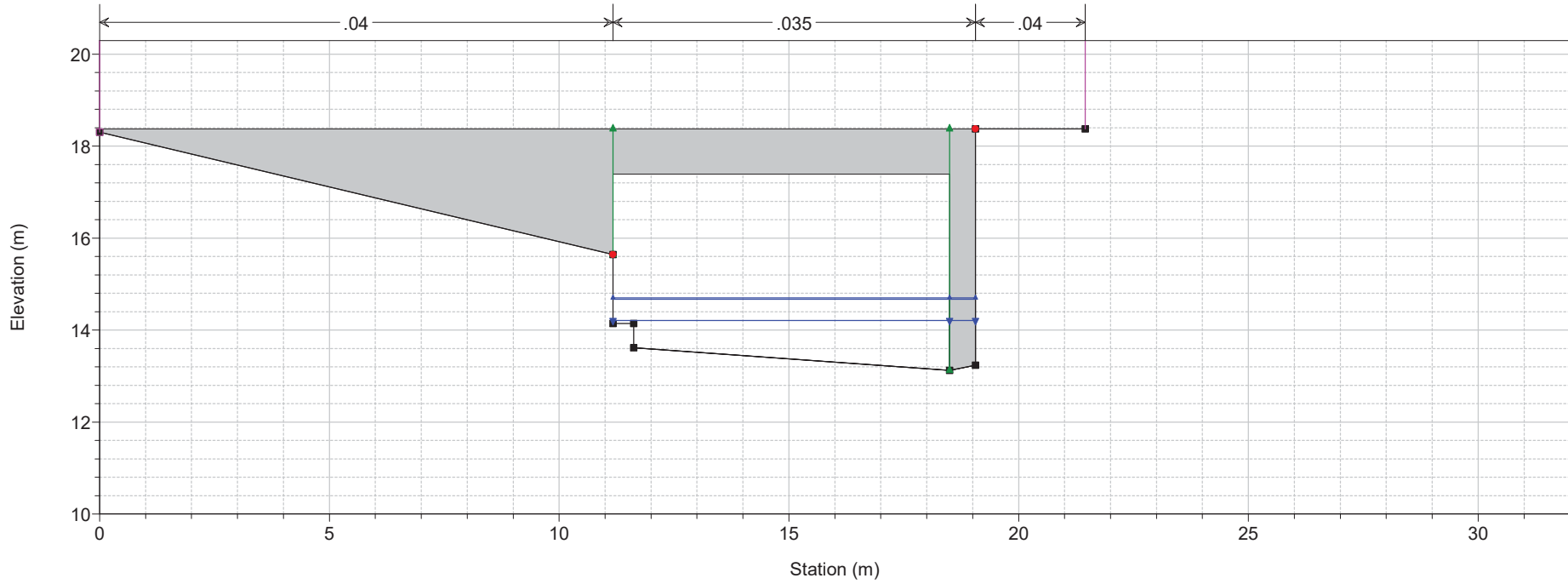

1) A TR 200 1.5h 2) A TR 200 3h 3) A TR 30 1.5h
 River = Crocetta Reach = Crocetta RS = 4 Sez. 4c

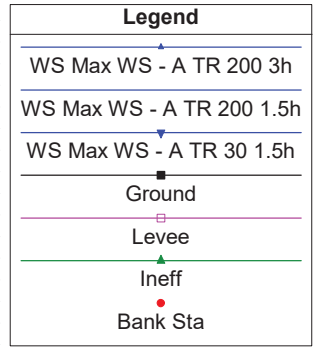
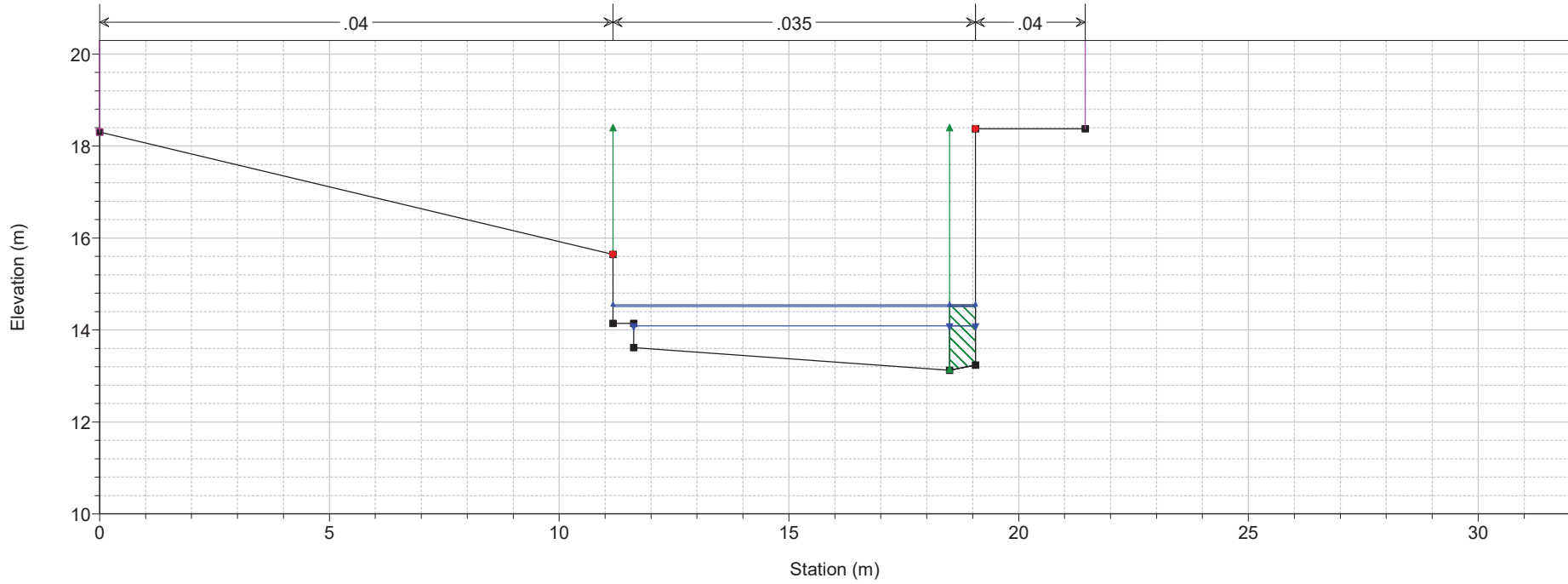

1) A TR 200 1.5h 2) A TR 200 3h 3) A TR 30 1.5h

River = Crocetta Reach = Crocetta RS = 3 Sez. 3c

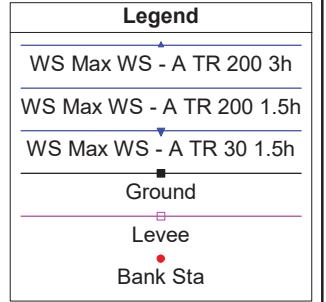
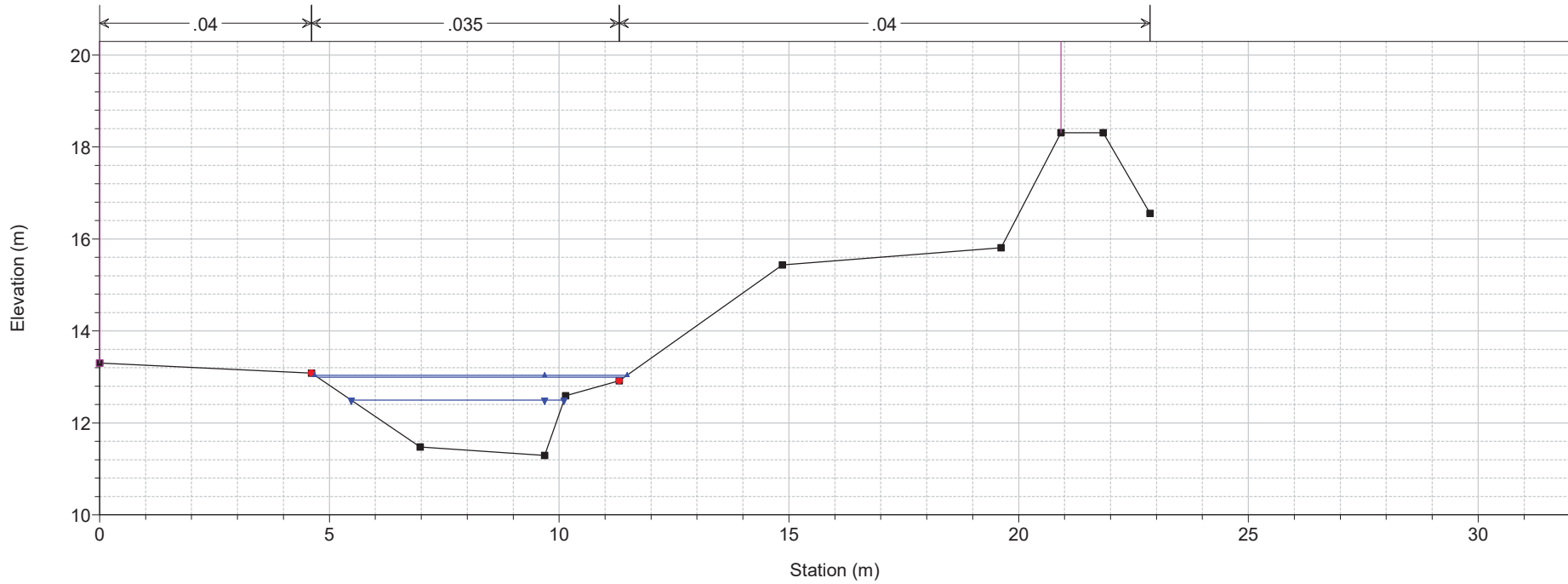

1) A TR 200 1.5h 2) A TR 200 3h 3) A TR 30 1.5h

River = Crocetta Reach = Crocetta RS = 2 Sez. 2c

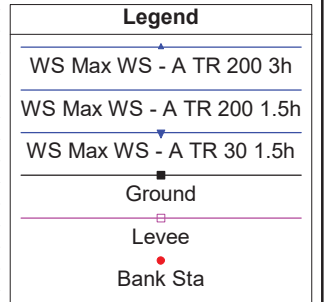
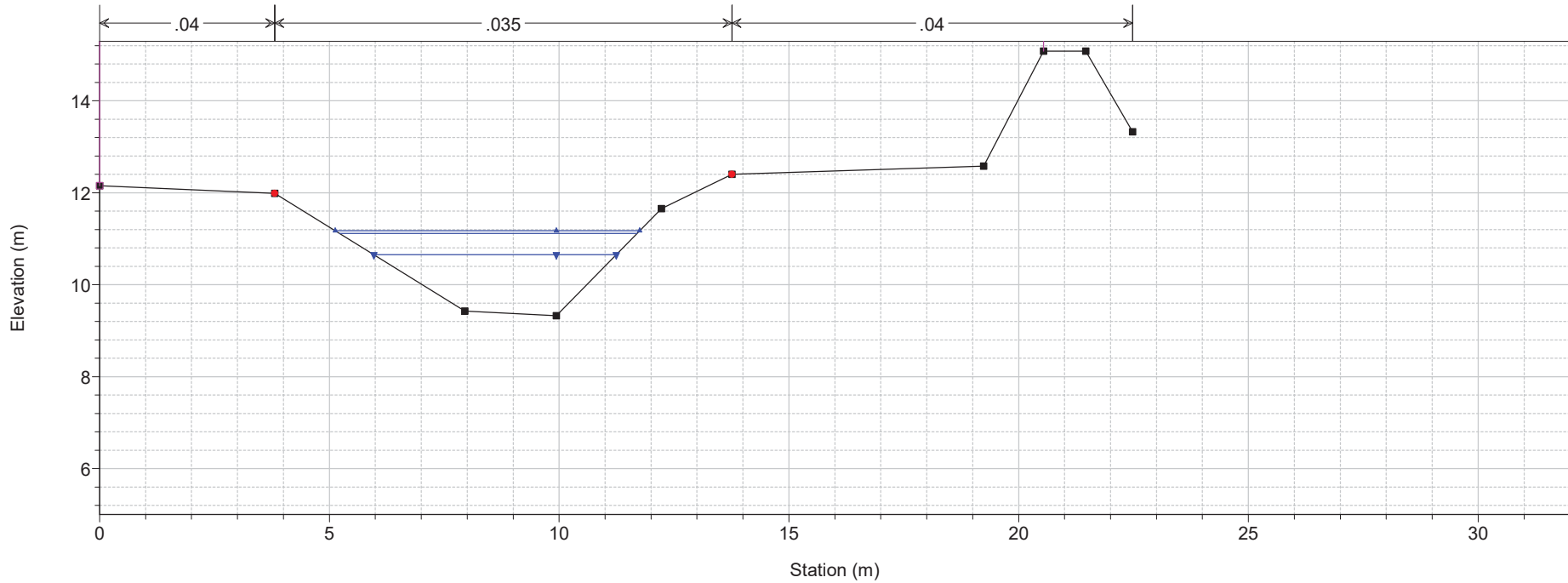

1) A TR 200 1.5h 2) A TR 200 3h 3) A TR 30 1.5h
 River = Crocetta Reach = Crocetta RS = 1 Sez. 1c

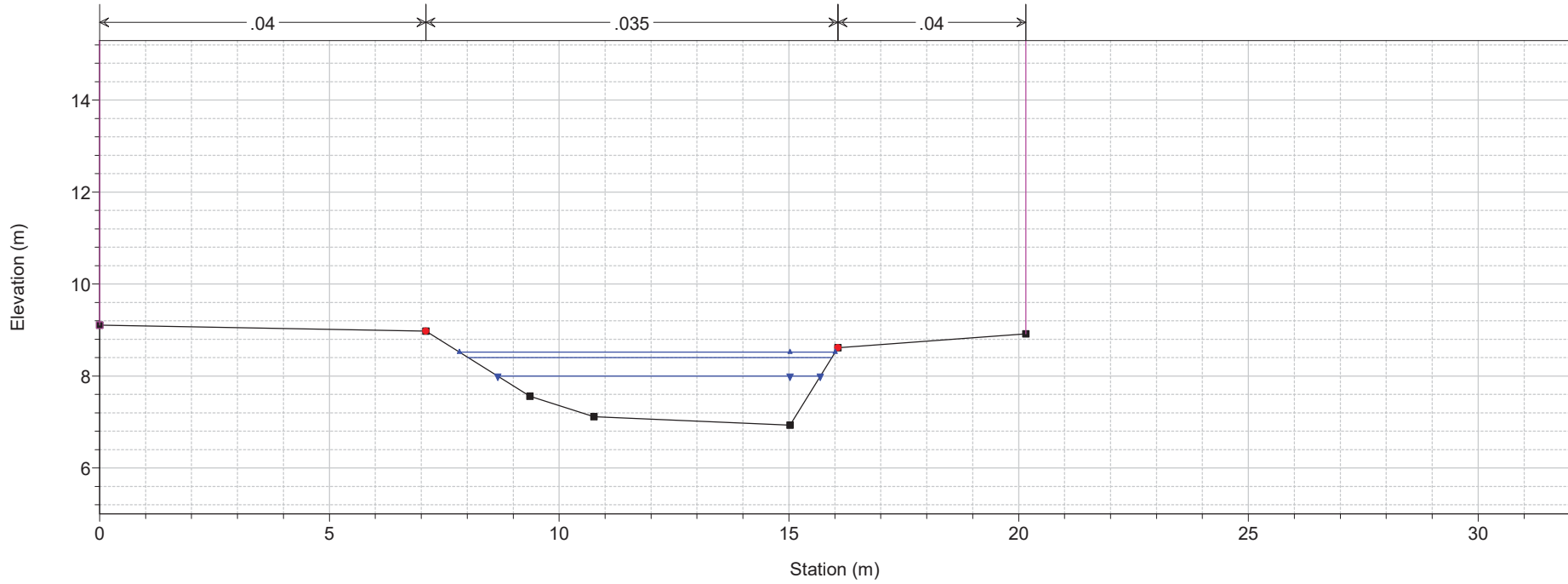

1) A TR 200 1.5h 2) A TR 200 3h 3) A TR 30 1.5h
 River = Crocetta Reach = Crocetta RS = 0.9

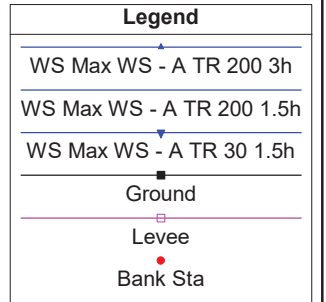
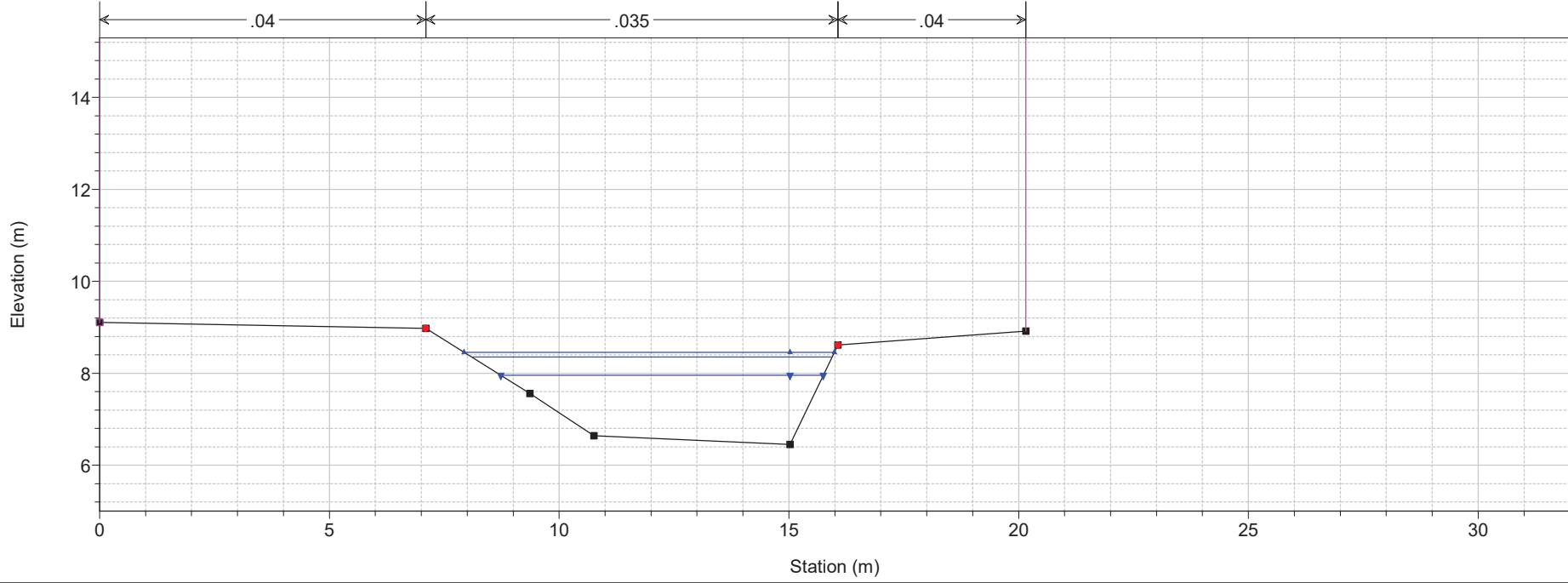

River	Reach	River Sta	Plan	Q Total (m3/s)	Min Ch El (m)	W.S. Elev (m)	Crit W.S. (m)	E.G. Elev (m)	E.G. Slope (m/m)	Vel Chnl (m/s)	Flow Area (m2)	Top Width (m)	Froude # Chl
lurco	lurco	18	A TR 200 1.5h	20.75	22.53	23.89	24.07	24.65	0.024194	3.87	5.36	5.21	1.22
lurco	lurco	18	A TR 200 3h	15.79	22.53	23.70	23.84	24.36	0.024885	3.60	4.38	4.98	1.22
lurco	lurco	18	A TR 30 1.5h	12.76	22.53	23.57	23.69	24.16	0.025309	3.39	3.76	4.83	1.23
lurco	lurco	18	P TR 200 1.5h	20.75	22.53	23.89	24.07	24.65	0.024194	3.87	5.36	5.21	1.22
lurco	lurco	18	P TR 200 3h	15.79	22.53	23.70	23.84	24.36	0.024885	3.60	4.38	4.98	1.22
lurco	lurco	18	P TR 30 1.5h	12.76	22.53	23.57	23.69	24.16	0.025309	3.39	3.76	4.83	1.23
lurco	lurco	17	A TR 200 1.5h	20.75	20.51	21.90	22.07	22.70	0.024319	3.96	5.24	4.97	1.23
lurco	lurco	17	A TR 200 3h	15.79	20.51	21.70	21.85	22.39	0.024442	3.68	4.29	4.63	1.22
lurco	lurco	17	A TR 30 1.5h	12.75	20.51	21.56	21.69	22.18	0.024578	3.48	3.67	4.39	1.22
lurco	lurco	17	P TR 200 1.5h	20.75	20.51	21.90	22.07	22.70	0.024319	3.96	5.24	4.97	1.23
lurco	lurco	17	P TR 200 3h	15.79	20.51	21.70	21.85	22.39	0.024442	3.68	4.29	4.63	1.22
lurco	lurco	17	P TR 30 1.5h	12.75	20.51	21.56	21.69	22.18	0.024578	3.48	3.67	4.39	1.22
lurco	lurco	16	A TR 200 1.5h	20.74	17.26	18.81	18.99	19.64	0.025112	4.04	5.13	4.69	1.23
lurco	lurco	16	A TR 200 3h	15.79	17.26	18.60	18.75	19.32	0.025086	3.76	4.19	4.33	1.22
lurco	lurco	16	A TR 30 1.5h	12.75	17.26	18.45	18.59	19.10	0.025047	3.56	3.59	4.07	1.21
lurco	lurco	16	P TR 200 1.5h	20.74	17.26	18.81	18.99	19.64	0.025112	4.04	5.13	4.69	1.23
lurco	lurco	16	P TR 200 3h	15.79	17.26	18.60	18.75	19.32	0.025086	3.76	4.19	4.33	1.22
lurco	lurco	16	P TR 30 1.5h	12.75	17.26	18.45	18.59	19.10	0.025047	3.56	3.59	4.07	1.21
lurco	lurco	15	A TR 200 1.5h	20.74	13.78	16.83	15.55	17.07	0.006128	2.15	9.70	5.81	0.52
lurco	lurco	15	A TR 200 3h	15.70	13.78	16.48	15.26	16.69	0.001367	2.03	7.73	5.55	0.40
lurco	lurco	15	A TR 30 1.5h	12.75	13.78	15.62	15.07	15.92	0.003338	2.44	5.22	5.19	0.58
lurco	lurco	15	P TR 200 1.5h	20.74	13.78	16.83	15.55	17.07	0.006128	2.15	9.70	5.81	0.52
lurco	lurco	15	P TR 200 3h	15.70	13.78	16.48	15.26	16.69	0.001367	2.03	7.73	5.55	0.40
lurco	lurco	15	P TR 30 1.5h	12.75	13.78	15.62	15.07	15.92	0.003338	2.44	5.22	5.19	0.58
lurco	lurco	14.5		Bridge									
lurco	lurco	14	A TR 200 1.5h	20.74	13.73	14.91	15.50	16.88	0.039471	6.23	3.33	6.45	1.85
lurco	lurco	14	A TR 200 3h	15.70	13.73	14.74	15.20	16.30	0.038445	5.53	2.84	6.16	1.78
lurco	lurco	14	A TR 30 1.5h	12.75	13.73	14.63	15.02	15.93	0.037721	5.05	2.52	5.97	1.73
lurco	lurco	14	P TR 200 1.5h	20.74	13.73	14.91	15.50	16.89	0.039506	6.23	3.33	6.45	1.85
lurco	lurco	14	P TR 200 3h	15.70	13.73	14.74	15.20	16.30	0.038445	5.53	2.84	6.16	1.78
lurco	lurco	14	P TR 30 1.5h	12.75	13.73	14.63	15.02	15.93	0.037721	5.05	2.52	5.97	1.73
lurco	lurco	13.99		Lat Struct									
lurco	lurco	13	A TR 200 1.5h	16.96	10.12	12.80	11.53	12.91	0.002034	1.49	11.35	5.15	0.32
lurco	lurco	13	A TR 200 3h	15.94	10.12	11.88	11.48	12.17	0.007510	2.37	6.71	4.79	0.64
lurco	lurco	13	A TR 30 1.5h	12.85	10.12	11.59	11.32	11.89	0.009020	2.39	5.37	4.52	0.70
lurco	lurco	13	P TR 200 1.5h	20.88	10.12	11.83	11.71	12.36	0.014215	3.22	6.48	4.74	0.88
lurco	lurco	13	P TR 200 3h	15.94	10.12	11.59	11.48	12.04	0.014198	2.99	5.33	4.51	0.88
lurco	lurco	13	P TR 30 1.5h	12.85	10.12	11.59	11.32	11.89	0.009020	2.39	5.37	4.52	0.70
lurco	lurco	12.5		Bridge									
lurco	lurco	12	A TR 200 1.5h	16.94	9.99	11.20	11.29	11.83	0.021505	3.54	4.79	4.81	1.13
lurco	lurco	12	A TR 200 3h	15.94	9.99	11.15	11.24	11.77	0.021530	3.48	4.58	4.77	1.13
lurco	lurco	12	A TR 30 1.5h	12.85	9.99	11.02	11.09	11.56	0.021522	3.26	3.94	4.66	1.13
lurco	lurco	12	P TR 200 1.5h	20.88	9.99	11.35	11.46	12.08	0.021680	3.77	5.53	4.93	1.14
lurco	lurco	12	P TR 200 3h	15.94	9.99	11.15	11.24	11.77	0.021531	3.48	4.58	4.77	1.13
lurco	lurco	12	P TR 30 1.5h	12.85	9.99	11.02	11.09	11.56	0.021522	3.26	3.94	4.66	1.13
lurco	lurco	11.99		Lat Struct									
lurco	lurco	11	A TR 200 1.5h	20.69	6.99	8.43	8.33	8.89	0.012760	3.01	6.88	5.76	0.88
lurco	lurco	11	A TR 200 3h	16.25	6.99	8.45	8.14	8.73	0.007494	2.32	7.00	5.78	0.67
lurco	lurco	11	A TR 30 1.5h	12.92	6.99	8.05	7.99	8.42	0.014144	2.72	4.75	5.27	0.91
lurco	lurco	11	P TR 200 1.5h	20.84	6.99	8.43	8.33	8.90	0.013036	3.04	6.86	5.75	0.89
lurco	lurco	11	P TR 200 3h	16.26	6.99	8.45	8.14	8.73	0.007497	2.32	7.00	5.78	0.67
lurco	lurco	11	P TR 30 1.5h	12.92	6.99	8.04	7.99	8.42	0.014663	2.75	4.69	5.25	0.93
lurco	lurco	10.8	A TR 200 1.5h	16.20	6.45	8.35	7.62	8.52	0.003487	1.78	9.11	5.79	0.45
lurco	lurco	10.8	A TR 200 3h	16.26	6.45	8.46	7.63	8.60	0.002951	1.67	9.71	5.89	0.42
lurco	lurco	10.8	A TR 30 1.5h	12.74	6.45	7.95	7.46	8.13	0.004685	1.85	6.88	5.40	0.52
lurco	lurco	10.8	P TR 200 1.5h	20.77	6.45	8.37	7.82	8.63	0.005615	2.26	9.18	5.80	0.57
lurco	lurco	10.8	P TR 200 3h	16.26	6.45	8.46	7.63	8.60	0.002951	1.67	9.71	5.89	0.42
lurco	lurco	10.8	P TR 30 1.5h	12.74	6.45	7.95	7.46	8.13	0.004708	1.86	6.87	5.39	0.52
lurco	lurco_valle	10.2	A TR 200 1.5h	39.27	6.43	8.35	8.30	9.05	0.014213	3.68	10.66	6.98	0.95
lurco	lurco_valle	10.2	A TR 200 3h	43.30	6.43	8.46	8.43	9.19	0.014090	3.80	11.52	9.97	0.95
lurco	lurco_valle	10.2	A TR 30 1.5h	25.87	6.43	7.95	7.89	8.49	0.013702	3.24	7.99	6.41	0.93
lurco	lurco_valle	10.2	P TR 200 1.5h	39.63	6.43	8.37	8.31	9.06	0.014143	3.69	10.74	7.19	0.95
lurco	lurco_valle	10.2	P TR 200 3h	43.30	6.43	8.46	8.43	9.19	0.014090	3.80	11.52	9.97	0.95
lurco	lurco_valle	10.2	P TR 30 1.5h	25.87	6.43	7.95	7.88	8.49	0.013765	3.24	7.97	6.40	0.93
lurco	lurco_valle	10	A TR 200 1.5h	39.27	6.37	8.31	8.24	8.99	0.013871	3.66	10.73	6.92	0.94
lurco	lurco_valle	10	A TR 200 3h	43.30	6.37	8.41	8.35	9.14	0.013954	3.78	11.48	8.59	0.94
lurco	lurco_valle	10	A TR 30 1.5h	25.87	6.37	7.92	7.82	8.43	0.012915	3.18	8.14	6.38	0.90
lurco	lurco_valle	10	P TR 200 1.5h	39.63	6.37	8.32	8.25	9.01	0.013815	3.66	10.81	6.94	0.94
lurco	lurco_valle	10	P TR 200 3h	43.30	6.37	8.41	8.35	9.14	0.013954	3.78	11.48	8.59	0.94
lurco	lurco_valle	10	P TR 30 1.5h	25.87	6.37	7.92	7.82	8.43	0.012904	3.18	8.14	6.38	0.90
lurco	lurco_valle	9	A TR 200 1.5h	38.90	5.17	7.19	6.91	7.61	0.007153	3.04	14.34	10.27	0.69
lurco	lurco_valle	9	A TR 200 3h	42.50	5.17	7.23	7.01	7.71	0.007949	3.24	14.75	10.40	0.73

River	Reach	River Sta	Plan	Q Total (m3/s)	Min Ch El (m)	W.S. Elev (m)	Crit W.S. (m)	E.G. Elev (m)	E.G. Slope (m/m)	Vel Chnl (m/s)	Flow Area (m2)	Top Width (m)	Froude #	Chl
lurco	lurco_valle	9	A TR 30 1.5h	24.22	5.17	6.74	6.48	7.07	0.007011	2.64	10.02	8.78		0.68
lurco	lurco_valle	9	P TR 200 1.5h	39.51	5.17	7.17	6.93	7.62	0.007674	3.14	14.12	10.20		0.72
lurco	lurco_valle	9	P TR 200 3h	42.54	5.17	7.23	7.01	7.71	0.007963	3.24	14.75	10.40		0.73
lurco	lurco_valle	9	P TR 30 1.5h	24.58	5.17	6.73	6.50	7.08	0.007250	2.68	10.00	8.77		0.69
lurco	lurco_valle	8.9	A TR 200 1.5h	47.39	4.49	7.02	6.02	7.23	0.002624	2.04	23.24	10.21		0.43
lurco	lurco_valle	8.9	A TR 200 3h	49.14	4.49	7.08	6.06	7.30	0.002593	2.05	23.92	10.22		0.43
lurco	lurco_valle	8.9	A TR 30 1.5h	31.53	4.49	6.37	5.71	6.55	0.003107	1.89	16.64	10.11		0.47
lurco	lurco_valle	8.9	P TR 200 1.5h	48.39	4.49	7.06	6.04	7.27	0.002602	2.05	23.65	10.22		0.43
lurco	lurco_valle	8.9	P TR 200 3h	49.14	4.49	7.08	6.06	7.30	0.002599	2.06	23.91	10.22		0.43
lurco	lurco_valle	8.9	P TR 30 1.5h	31.53	4.49	6.37	5.71	6.55	0.003100	1.89	16.65	10.11		0.47
lurco	lurco_valle	8.8	A TR 200 1.5h	47.39	4.06	6.82	5.89	7.19	0.005243	2.71	17.51	6.56		0.53
lurco	lurco_valle	8.8	A TR 200 3h	49.14	4.06	6.88	5.93	7.26	0.005307	2.75	17.90	6.56		0.53
lurco	lurco_valle	8.8	A TR 30 1.5h	31.53	4.06	6.24	5.47	6.51	0.004551	2.30	13.72	6.55		0.51
lurco	lurco_valle	8.8	P TR 200 1.5h	48.39	4.06	6.85	5.91	7.23	0.005280	2.73	17.73	6.56		0.53
lurco	lurco_valle	8.8	P TR 200 3h	49.14	4.06	6.88	5.93	7.26	0.005307	2.75	17.90	6.56		0.53
lurco	lurco_valle	8.8	P TR 30 1.5h	31.53	4.06	6.24	5.47	6.51	0.004551	2.30	13.72	6.55		0.51
lurco	lurco_valle	8.6		Bridge										
lurco	lurco_valle	8.47368	A TR 200 1.5h	47.37	4.12	5.69	5.65	6.27	0.011939	3.36	14.08	11.03		0.95
lurco	lurco_valle	8.47368	A TR 200 3h	49.13	4.12	5.72	5.68	6.31	0.011969	3.41	14.42	11.08		0.95
lurco	lurco_valle	8.47368	A TR 30 1.5h	31.53	4.12	5.37	5.33	5.82	0.012086	2.96	10.64	10.45		0.94
lurco	lurco_valle	8.47368	P TR 200 1.5h	48.38	4.12	5.74	5.67	6.30	0.011092	3.30	14.65	11.12		0.92
lurco	lurco_valle	8.47368	P TR 200 3h	49.14	4.12	5.76	5.68	6.32	0.011040	3.31	14.83	11.15		0.92
lurco	lurco_valle	8.47368	P TR 30 1.5h	31.53	4.12	5.37	5.33	5.82	0.012107	2.97	10.63	10.45		0.94
lurco	lurco_valle	8.46		Lat Struct										
lurco	lurco_valle	8.4	A TR 200 1.5h	45.55	3.84	5.20	5.53	6.45	0.030916	4.95	9.20	7.54		1.43
lurco	lurco_valle	8.4	A TR 200 3h	46.76	3.84	5.24	5.56	6.48	0.029670	4.93	9.49	7.54		1.40
lurco	lurco_valle	8.4	A TR 30 1.5h	31.69	3.84	4.80	5.20	6.14	0.048772	5.12	6.19	7.31		1.77
lurco	lurco_valle	8.4	P TR 200 1.5h	48.61	3.84	5.29	5.54	6.12	0.020466	4.28	13.51	18.08		1.19
lurco	lurco_valle	8.4	P TR 200 3h	49.30	3.84	5.32	5.55	6.12	0.019508	4.22	13.93	18.11		1.17
lurco	lurco_valle	8.4	P TR 30 1.5h	31.69	3.84	4.80	5.20	6.15	0.049722	5.15	6.15	7.30		1.79
lurco	lurco_valle	8.3	A TR 200 1.5h	46.05	2.07	4.99	4.27	5.39	0.005494	2.81	16.41	7.12		0.59
lurco	lurco_valle	8.3	A TR 200 3h	47.56	2.07	5.06	4.31	5.46	0.005418	2.82	16.89	7.12		0.58
lurco	lurco_valle	8.3	A TR 30 1.5h	31.76	2.07	4.36	3.85	4.72	0.006216	2.65	11.99	6.87		0.64
lurco	lurco_valle	8.3	P TR 200 1.5h	48.69	2.07	5.16	4.34	5.43	0.003543	2.40	23.87	18.01		0.49
lurco	lurco_valle	8.3	P TR 200 3h	49.36	2.07	5.18	4.36	5.44	0.003524	2.40	24.20	18.04		0.49
lurco	lurco_valle	8.3	P TR 30 1.5h	31.76	2.07	4.36	3.85	4.72	0.006252	2.65	11.97	6.86		0.64
lurco	lurco_valle	8	A TR 200 1.5h	47.85	1.87	4.77	3.82	5.20	0.004408	2.91	16.53	8.29		0.55
lurco	lurco_valle	8	A TR 200 3h	49.37	1.87	4.82	3.86	5.26	0.004434	2.95	16.82	8.36		0.55
lurco	lurco_valle	8	A TR 30 1.5h	31.88	1.87	4.21	3.35	4.50	0.004039	2.41	13.28	7.47		0.50
lurco	lurco_valle	8	P TR 200 1.5h	48.88	1.87	4.80	3.85	5.24	0.004426	2.94	16.73	8.34		0.55
lurco	lurco_valle	8	P TR 200 3h	49.49	1.87	4.82	3.87	5.27	0.004436	2.95	16.84	8.37		0.55
lurco	lurco_valle	8	P TR 30 1.5h	31.88	1.87	4.21	3.35	4.50	0.004040	2.41	13.28	7.47		0.50
lurco	lurco_valle	7.5		Bridge										
lurco	lurco_valle	7	A TR 200 1.5h	47.85	1.96	3.95	4.11	5.09	0.014624	4.74	10.09	8.48		1.14
lurco	lurco_valle	7	A TR 200 3h	49.37	1.96	3.98	4.15	5.16	0.014638	4.80	10.28	8.48		1.14
lurco	lurco_valle	7	A TR 30 1.5h	31.88	1.96	3.58	3.65	4.39	0.014114	3.99	7.99	8.48		1.08
lurco	lurco_valle	7	P TR 200 1.5h	48.88	1.96	3.97	4.13	5.14	0.014556	4.78	10.23	8.48		1.14
lurco	lurco_valle	7	P TR 200 3h	49.49	1.96	3.98	4.15	5.16	0.014628	4.81	10.29	8.48		1.14
lurco	lurco_valle	7	P TR 30 1.5h	31.88	1.96	3.58	3.65	4.39	0.014085	3.99	8.00	8.48		1.07
lurco	lurco_valle	6	A TR 200 1.5h	47.94	1.54	3.29	3.25	4.00	0.014123	3.75	12.77	8.26		0.96
lurco	lurco_valle	6	A TR 200 3h	49.47	1.54	3.32	3.28	4.05	0.014145	3.79	13.04	8.26		0.96
lurco	lurco_valle	6	A TR 30 1.5h	32.01	1.54	2.92	2.89	3.47	0.014129	3.28	9.75	8.25		0.96
lurco	lurco_valle	6	P TR 200 1.5h	49.08	1.54	3.31	3.27	4.04	0.014204	3.79	12.95	8.26		0.97
lurco	lurco_valle	6	P TR 200 3h	49.62	1.54	3.32	3.28	4.06	0.014147	3.80	13.07	8.26		0.96
lurco	lurco_valle	6	P TR 30 1.5h	32.01	1.54	2.92	2.89	3.47	0.014220	3.29	9.73	8.25		0.97
lurco	lurco_valle	5	A TR 200 1.5h	48.07	0.88	2.65	2.49	3.25	0.011175	3.42	14.05	8.66		0.86
lurco	lurco_valle	5	A TR 200 3h	49.49	0.88	2.68	2.52	3.29	0.011189	3.46	14.32	8.66		0.86
lurco	lurco_valle	5	A TR 30 1.5h	32.15	0.88	2.28	2.15	2.73	0.010876	2.97	10.84	8.66		0.85
lurco	lurco_valle	5	P TR 200 1.5h	49.27	0.88	2.68	2.52	3.29	0.011132	3.44	14.30	8.66		0.86
lurco	lurco_valle	5	P TR 200 3h	49.59	0.88	2.68	2.52	3.29	0.011216	3.46	14.33	8.66		0.86
lurco	lurco_valle	5	P TR 30 1.5h	32.16	0.88	2.28	2.15	2.73	0.010904	2.97	10.83	8.66		0.85
lurco	lurco_valle	4.5		Bridge										
lurco	lurco_valle	4	A TR 200 1.5h	48.07	0.86	2.67	2.42	3.20	0.009666	3.23	14.87	8.77		0.79
lurco	lurco_valle	4	A TR 200 3h	49.59	0.86	2.70	2.46	3.25	0.009702	3.27	15.17	8.77		0.79
lurco	lurco_valle	4	A TR 30 1.5h	32.16	0.86	2.27	2.08	2.68	0.009705	2.83	11.35	8.77		0.79
lurco	lurco_valle	4	P TR 200 1.5h	49.30	0.86	2.69	2.45	3.24	0.009745	3.27	15.09	8.77		0.80
lurco	lurco_valle	4	P TR 200 3h	49.78	0.86	2.71	2.46	3.25	0.009696	3.27	15.21	8.77		0.79
lurco	lurco_valle	4	P TR 30 1.5h	32.16	0.86	2.26	2.08	2.67	0.009811	2.84	11.31	8.77		0.80
lurco	lurco_valle	3	A TR 200 1.5h	48.20	0.42	2.30	2.05	2.83	0.009341	3.23	14.94	8.71		0.79
lurco	lurco_valle	3	A TR 200 3h	49.70	0.42	2.33	2.08	2.88	0.009419	3.27	15.21	8.71		0.79
lurco	lurco_valle	3	A TR 30 1.5h	32.26	0.42	1.92	1.70	2.32	0.008822	2.77	11.63	8.71		0.77
lurco	lurco_valle	3	P TR 200 1.5h	49.46	0.42	2.31	2.07	2.86	0.009683	3.29	15.02	8.71		0.80

River	Reach	River Sta	Plan	Q Total (m3/s)	Min Ch El (m)	W.S. Elev (m)	Crit W.S. (m)	E.G. Elev (m)	E.G. Slope (m/m)	Vel Chnl (m/s)	Flow Area (m2)	Top Width (m)	Froude # Chl
lurco	lurco_valle	3	P TR 200 3h	49.89	0.42	2.34	2.08	2.88	0.009417	3.27	15.26	8.71	0.79
lurco	lurco_valle	3	P TR 30 1.5h	32.27	0.42	1.91	1.71	2.31	0.009071	2.80	11.53	8.71	0.78
lurco	lurco_valle	2	A TR 200 1.5h	48.44	0.18	2.23	1.34	2.41	0.002155	1.90	25.50	12.71	0.43
lurco	lurco_valle	2	A TR 200 3h	49.89	0.18	2.26	1.37	2.45	0.002157	1.92	25.98	12.71	0.43
lurco	lurco_valle	2	A TR 30 1.5h	32.46	0.18	1.78	1.08	1.91	0.002137	1.63	19.87	12.67	0.41
lurco	lurco_valle	2	P TR 200 1.5h	49.76	0.18	2.26	1.37	2.45	0.002156	1.92	25.94	12.71	0.43
lurco	lurco_valle	2	P TR 200 3h	50.10	0.18	2.27	1.37	2.46	0.002157	1.92	26.05	12.71	0.43
lurco	lurco_valle	2	P TR 30 1.5h	32.47	0.18	1.78	1.07	1.91	0.002137	1.63	19.87	12.67	0.41
lurco	lurco_valle	1.5		Bridge									
lurco	lurco_valle	1.1	A TR 200 1.5h	48.44	0.18	2.12	1.36	2.34	0.002699	2.09	23.20	17.32	0.48
lurco	lurco_valle	1.1	A TR 200 3h	49.89	0.18	2.15	1.39	2.38	0.002700	2.11	23.64	17.40	0.48
lurco	lurco_valle	1.1	A TR 30 1.5h	32.46	0.18	1.68	1.09	1.85	0.002699	1.80	18.02	16.39	0.47
lurco	lurco_valle	1.1	P TR 200 1.5h	49.76	0.18	2.15	1.39	2.38	0.002699	2.11	23.60	17.39	0.48
lurco	lurco_valle	1.1	P TR 200 3h	50.10	0.18	2.16	1.39	2.39	0.002700	2.11	23.70	17.41	0.48
lurco	lurco_valle	1.1	P TR 30 1.5h	32.47	0.18	1.68	1.09	1.85	0.002698	1.80	18.02	16.39	0.47
lurco	lurco_valle	1	A TR 200 1.5h	48.44	0.18	2.12	1.36	2.34	0.002702	2.09	23.19	17.32	0.48
lurco	lurco_valle	1	A TR 200 3h	49.89	0.18	2.15	1.39	2.38	0.002701	2.11	23.64	17.40	0.48
lurco	lurco_valle	1	A TR 30 1.5h	32.46	0.18	1.68	1.09	1.85	0.002701	1.80	18.02	16.39	0.47
lurco	lurco_valle	1	P TR 200 1.5h	49.76	0.18	2.15	1.39	2.38	0.002701	2.11	23.60	17.39	0.48
lurco	lurco_valle	1	P TR 200 3h	50.10	0.18	2.16	1.39	2.39	0.002701	2.11	23.70	17.41	0.48
lurco	lurco_valle	1	P TR 30 1.5h	32.47	0.18	1.68	1.09	1.85	0.002700	1.80	18.02	16.39	0.47
Crocetta	Crocetta	15	A TR 200 1.5h	24.71	35.68	37.60	36.66	37.72	0.001804	1.54	16.51	10.10	0.36
Crocetta	Crocetta	15	A TR 200 3h	22.99	35.68	37.47	36.61	37.59	0.001987	1.55	15.22	9.88	0.37
Crocetta	Crocetta	15	A TR 30 1.5h	12.00	35.68	36.22	36.29	36.60	0.024968	2.76	4.35	8.32	1.22
Crocetta	Crocetta	15	P TR 200 1.5h	24.71	35.68	37.60	36.66	37.72	0.001798	1.54	16.53	10.10	0.36
Crocetta	Crocetta	15	P TR 200 3h	22.99	35.68	37.47	36.61	37.59	0.001987	1.55	15.22	9.88	0.37
Crocetta	Crocetta	15	P TR 30 1.5h	12.00	35.68	36.22	36.29	36.60	0.023891	2.72	4.41	8.32	1.19
Crocetta	Crocetta	14	A TR 200 1.5h	24.70	34.21	37.50	37.12	37.69	0.004255	1.97	13.60	11.68	0.54
Crocetta	Crocetta	14	A TR 200 3h	22.99	34.21	37.35	37.08	37.56	0.005645	2.09	11.83	11.68	0.61
Crocetta	Crocetta	14	A TR 30 1.5h	12.00	34.21	35.77	35.64	36.38	0.007994	3.44	3.49	6.23	0.88
Crocetta	Crocetta	14	P TR 200 1.5h	24.70	34.21	37.50	37.12	37.69	0.004255	1.97	13.60	11.68	0.54
Crocetta	Crocetta	14	P TR 200 3h	22.99	34.21	37.35	37.08	37.56	0.005645	2.09	11.83	11.68	0.61
Crocetta	Crocetta	14	P TR 30 1.5h	12.00	34.21	35.77	35.64	36.38	0.007994	3.44	3.49	6.23	0.88
Crocetta	Crocetta	13.5		Bridge									
Crocetta	Crocetta	13	A TR 200 1.5h	24.70	34.21	35.68	36.36	37.98	0.032954	6.71	3.68	6.04	1.77
Crocetta	Crocetta	13	A TR 200 3h	22.99	34.21	35.63	36.26	37.77	0.032432	6.49	3.54	5.92	1.74
Crocetta	Crocetta	13	A TR 30 1.5h	12.00	34.21	35.20	35.54	36.40	0.029394	4.86	2.47	5.00	1.56
Crocetta	Crocetta	13	P TR 200 1.5h	24.70	34.21	35.68	36.36	37.98	0.032954	6.71	3.68	6.04	1.77
Crocetta	Crocetta	13	P TR 200 3h	22.99	34.21	35.63	36.26	37.77	0.032432	6.49	3.54	5.92	1.74
Crocetta	Crocetta	13	P TR 30 1.5h	12.00	34.21	35.20	35.54	36.40	0.029394	4.86	2.47	5.00	1.56
Crocetta	Crocetta	12	A TR 200 1.5h	24.70	32.09	33.36	33.68	34.34	0.029726	4.51	5.95	7.92	1.46
Crocetta	Crocetta	12	A TR 200 3h	22.99	32.09	33.32	33.62	34.26	0.029824	4.42	5.63	7.70	1.45
Crocetta	Crocetta	12	A TR 30 1.5h	12.00	32.09	32.99	33.20	33.65	0.030405	3.61	3.43	5.99	1.40
Crocetta	Crocetta	12	P TR 200 1.5h	24.70	32.09	33.36	33.68	34.34	0.029726	4.51	5.95	7.92	1.46
Crocetta	Crocetta	12	P TR 200 3h	22.99	32.09	33.32	33.62	34.26	0.029824	4.42	5.63	7.70	1.45
Crocetta	Crocetta	12	P TR 30 1.5h	12.00	32.09	32.99	33.20	33.65	0.030404	3.61	3.43	5.99	1.40
Crocetta	Crocetta	11	A TR 200 1.5h	24.81	24.75	26.30	26.37	26.97	0.017769	3.61	6.87	6.08	1.09
Crocetta	Crocetta	11	A TR 200 3h	23.46	24.75	26.26	26.33	26.90	0.017652	3.54	6.62	6.03	1.08
Crocetta	Crocetta	11	A TR 30 1.5h	12.06	24.75	25.84	25.87	26.26	0.018026	2.90	4.16	5.52	1.07
Crocetta	Crocetta	11	P TR 200 1.5h	24.81	24.75	26.30	26.37	26.97	0.017769	3.61	6.87	6.08	1.09
Crocetta	Crocetta	11	P TR 200 3h	23.46	24.75	26.26	26.32	26.90	0.017652	3.54	6.62	6.03	1.08
Crocetta	Crocetta	11	P TR 30 1.5h	12.06	24.75	25.84	25.87	26.26	0.018026	2.90	4.16	5.52	1.07
Crocetta	Crocetta	10	A TR 200 1.5h	24.88	22.09	23.75	23.84	24.52	0.019893	3.88	6.42	5.07	1.10
Crocetta	Crocetta	10	A TR 200 3h	24.11	22.09	23.72	23.81	24.47	0.019725	3.83	6.29	5.03	1.09
Crocetta	Crocetta	10	A TR 30 1.5h	12.09	22.09	23.20	23.24	23.71	0.019624	3.16	3.82	4.30	1.07
Crocetta	Crocetta	10	P TR 200 1.5h	24.88	22.09	23.75	23.84	24.52	0.019893	3.88	6.42	5.07	1.10
Crocetta	Crocetta	10	P TR 200 3h	24.11	22.09	23.72	23.81	24.47	0.019725	3.83	6.29	5.03	1.09
Crocetta	Crocetta	10	P TR 30 1.5h	12.09	22.09	23.20	23.24	23.71	0.019624	3.16	3.82	4.30	1.07
Crocetta	Crocetta	9	A TR 200 1.5h	24.97	18.65	20.16	20.29	20.95	0.022027	3.94	6.34	5.37	1.16
Crocetta	Crocetta	9	A TR 200 3h	24.93	18.65	20.16	20.29	20.94	0.021897	3.93	6.34	5.37	1.15
Crocetta	Crocetta	9	A TR 30 1.5h	12.14	18.65	19.66	19.73	20.17	0.020965	3.16	3.85	4.73	1.12
Crocetta	Crocetta	9	P TR 200 1.5h	24.97	18.65	20.16	20.29	20.95	0.022027	3.94	6.34	5.37	1.16
Crocetta	Crocetta	9	P TR 200 3h	24.93	18.65	20.16	20.29	20.94	0.021896	3.93	6.34	5.37	1.15
Crocetta	Crocetta	9	P TR 30 1.5h	12.14	18.65	19.66	19.73	20.17	0.020964	3.16	3.85	4.73	1.12
Crocetta	Crocetta	8	A TR 200 1.5h	25.07	14.14	16.50	15.42	16.59	0.001343	1.34	18.72	10.50	0.32
Crocetta	Crocetta	8	A TR 200 3h	25.92	14.14	16.52	15.44	16.62	0.001379	1.37	18.99	10.53	0.32
Crocetta	Crocetta	8	A TR 30 1.5h	12.19	14.14	16.05	14.95	16.09	0.000704	0.86	14.21	9.86	0.23
Crocetta	Crocetta	8	P TR 200 1.5h	25.07	14.14	16.50	15.42	16.59	0.001343	1.34	18.72	10.50	0.32
Crocetta	Crocetta	8	P TR 200 3h	25.92	14.14	16.52	15.44	16.62	0.001379	1.37	18.99	10.53	0.32
Crocetta	Crocetta	8	P TR 30 1.5h	12.19	14.14	16.05	14.95	16.09	0.000704	0.86	14.21	9.86	0.23
Crocetta	Crocetta	7.95		Ini Struct									
Crocetta	Crocetta	7.9	A TR 200 1.5h	25.07	14.14	16.20	15.42	16.33	0.002236	1.60	15.68	10.07	0.41

River	Reach	River Sta	Plan	Q Total (m3/s)	Min Ch El (m)	W.S. Elev (m)	Crit W.S. (m)	E.G. Elev (m)	E.G. Slope (m/m)	Vel Chnl (m/s)	Flow Area (m2)	Top Width (m)	Froude # Chl
Crocetta	Crocetta	7.9	A TR 200 3h	25.92	14.14	16.25	15.44	16.38	0.002173	1.60	16.21	10.15	0.40
Crocetta	Crocetta	7.9	A TR 30 1.5h	12.19	14.14	15.43	14.95	15.54	0.003296	1.45	8.39	8.83	0.48
Crocetta	Crocetta	7.9	P TR 200 1.5h	25.07	14.14	16.22	15.42	16.35	0.002159	1.58	15.87	10.10	0.40
Crocetta	Crocetta	7.9	P TR 200 3h	25.92	14.14	16.25	15.44	16.38	0.002173	1.60	16.21	10.15	0.40
Crocetta	Crocetta	7.9	P TR 30 1.5h	12.19	14.14	15.44	14.95	15.55	0.003223	1.44	8.47	8.88	0.47
Crocetta	Crocetta	7	A TR 200 1.5h	25.09	14.04	15.81	15.50	16.29	0.008770	3.06	8.19	5.84	0.74
Crocetta	Crocetta	7	A TR 200 3h	26.01	14.04	15.85	15.54	16.34	0.008783	3.10	8.39	5.87	0.74
Crocetta	Crocetta	7	A TR 30 1.5h	12.20	14.04	15.17	14.96	15.45	0.008535	2.37	5.15	5.30	0.73
Crocetta	Crocetta	7	P TR 200 1.5h	25.09	14.04	15.81	15.50	16.29	0.008770	3.06	8.19	5.84	0.74
Crocetta	Crocetta	7	P TR 200 3h	26.01	14.04	15.85	15.54	16.34	0.008783	3.10	8.39	5.87	0.74
Crocetta	Crocetta	7	P TR 30 1.5h	12.20	14.04	15.17	14.96	15.45	0.008535	2.37	5.15	5.30	0.73
Crocetta	Crocetta	6.5		Bridge									
Crocetta	Crocetta	6	A TR 200 1.5h	25.09	14.04	15.10	15.48	16.43	0.048927	5.11	4.91	4.62	1.58
Crocetta	Crocetta	6	A TR 200 3h	26.01	14.04	15.13	15.52	16.49	0.048498	5.16	5.05	4.62	1.57
Crocetta	Crocetta	6	A TR 30 1.5h	11.96	14.04	14.70	14.92	15.48	0.045298	3.91	3.06	4.62	1.53
Crocetta	Crocetta	6	P TR 200 1.5h	25.09	14.04	15.10	15.48	16.43	0.048927	5.11	4.91	4.62	1.58
Crocetta	Crocetta	6	P TR 200 3h	26.01	14.04	15.13	15.52	16.49	0.048498	5.16	5.05	4.62	1.57
Crocetta	Crocetta	6	P TR 30 1.5h	12.08	14.04	14.71	14.93	15.49	0.045401	3.92	3.08	4.62	1.53
Crocetta	Crocetta	5	A TR 200 1.5h	25.09	13.32	14.83	14.68	15.26	0.011934	2.91	8.63	6.88	0.83
Crocetta	Crocetta	5	A TR 200 3h	26.06	13.32	14.86	14.71	15.30	0.011960	2.95	8.84	6.88	0.83
Crocetta	Crocetta	5	A TR 30 1.5h	12.04	13.32	14.50	14.25	14.68	0.006942	1.90	6.35	6.88	0.63
Crocetta	Crocetta	5	P TR 200 1.5h	25.09	13.32	14.83	14.68	15.26	0.011934	2.91	8.63	6.88	0.83
Crocetta	Crocetta	5	P TR 200 3h	26.06	13.32	14.86	14.71	15.30	0.011960	2.95	8.84	6.88	0.83
Crocetta	Crocetta	5	P TR 30 1.5h	12.07	13.32	14.50	14.25	14.68	0.006877	1.89	6.38	6.88	0.63
Crocetta	Crocetta	4.5		Bridge									
Crocetta	Crocetta	4	A TR 200 1.5h	25.09	13.12	14.51	14.48	15.01	0.012361	3.12	8.03	7.89	0.95
Crocetta	Crocetta	4	A TR 200 3h	26.06	13.12	14.55	14.51	15.05	0.012117	3.15	8.28	7.89	0.94
Crocetta	Crocetta	4	A TR 30 1.5h	12.54	13.12	14.09	14.06	14.41	0.013380	2.54	4.95	7.44	0.95
Crocetta	Crocetta	4	P TR 200 1.5h	25.09	13.12	14.51	14.48	15.01	0.012459	3.13	8.01	7.89	0.96
Crocetta	Crocetta	4	P TR 200 3h	26.06	13.12	14.55	14.51	15.05	0.012117	3.15	8.28	7.89	0.94
Crocetta	Crocetta	4	P TR 30 1.5h	12.47	13.12	14.08	14.06	14.41	0.013458	2.53	4.92	7.44	0.96
Crocetta	Crocetta	3	A TR 200 1.5h	25.14	11.29	12.99	13.11	13.69	0.020712	3.69	6.81	6.67	1.16
Crocetta	Crocetta	3	A TR 200 3h	26.57	11.29	13.04	13.17	13.75	0.020319	3.74	7.12	6.80	1.15
Crocetta	Crocetta	3	A TR 30 1.5h	12.79	11.29	12.49	12.55	13.01	0.020105	3.18	4.03	4.63	1.09
Crocetta	Crocetta	3	P TR 200 1.5h	25.14	11.29	12.99	13.11	13.69	0.020712	3.69	6.81	6.67	1.16
Crocetta	Crocetta	3	P TR 200 3h	26.57	11.29	13.04	13.17	13.75	0.020319	3.74	7.12	6.80	1.15
Crocetta	Crocetta	3	P TR 30 1.5h	12.77	11.29	12.49	12.55	13.01	0.020108	3.17	4.02	4.63	1.09
Crocetta	Crocetta	2	A TR 200 1.5h	25.19	9.33	11.11	11.14	11.72	0.015440	3.44	7.33	6.47	1.03
Crocetta	Crocetta	2	A TR 200 3h	27.04	9.33	11.17	11.21	11.80	0.015514	3.50	7.72	6.62	1.04
Crocetta	Crocetta	2	A TR 30 1.5h	13.25	9.33	10.65	10.64	11.07	0.014821	2.87	4.62	5.27	0.98
Crocetta	Crocetta	2	P TR 200 1.5h	25.19	9.33	11.11	11.14	11.72	0.015440	3.44	7.33	6.47	1.03
Crocetta	Crocetta	2	P TR 200 3h	27.04	9.33	11.17	11.21	11.80	0.015514	3.50	7.72	6.62	1.04
Crocetta	Crocetta	2	P TR 30 1.5h	13.24	9.33	10.65	10.64	11.07	0.014827	2.87	4.62	5.27	0.98
Crocetta	Crocetta	1	A TR 200 1.5h	23.40	6.93	8.40	8.26	8.78	0.009683	2.72	8.61	7.92	0.83
Crocetta	Crocetta	1	A TR 200 3h	27.04	6.93	8.52	8.37	8.93	0.009683	2.84	9.53	8.17	0.84
Crocetta	Crocetta	1	A TR 30 1.5h	13.21	6.93	8.00	7.91	8.28	0.010861	2.37	5.56	7.02	0.85
Crocetta	Crocetta	1	P TR 200 1.5h	25.00	6.93	8.39	8.31	8.83	0.011519	2.95	8.48	7.89	0.91
Crocetta	Crocetta	1	P TR 200 3h	27.04	6.93	8.52	8.37	8.93	0.009683	2.84	9.53	8.17	0.84
Crocetta	Crocetta	1	P TR 30 1.5h	13.20	6.93	7.98	7.91	8.28	0.011346	2.41	5.48	6.99	0.87
Crocetta	Crocetta	0.9	A TR 200 1.5h	23.07	6.45	8.35	7.85	8.58	0.004680	2.13	10.84	7.84	0.58
Crocetta	Crocetta	0.9	A TR 200 3h	27.04	6.45	8.46	7.98	8.73	0.005268	2.32	11.66	8.06	0.62
Crocetta	Crocetta	0.9	A TR 30 1.5h	13.13	6.45	7.95	7.47	8.10	0.003682	1.67	7.88	7.02	0.50
Crocetta	Crocetta	0.9	P TR 200 1.5h	18.85	6.45	8.37	7.70	8.52	0.003053	1.72	10.94	7.87	0.47
Crocetta	Crocetta	0.9	P TR 200 3h	27.04	6.45	8.46	7.98	8.73	0.005268	2.32	11.66	8.06	0.62
Crocetta	Crocetta	0.9	P TR 30 1.5h	13.13	6.45	7.95	7.47	8.09	0.003699	1.67	7.86	7.01	0.50

River	Reach	River Sta	Plan	Q US (m3/s)	Q Leaving Total (m3/s)	Q DS (m3/s)	Q Weir (m3/s)	Q Gates (m3/s)	Wr Top Width (m)	Weir Max Depth (m)	Weir Avg Depth (m)	Min El Weir Flow (m)	E.G. US. (m)	W.S. US. (m)	E.G. DS (m)	W.S. DS (m)
Iurco	Iurco	13.99	A TR 200 1.5h	20.74	3.91	16.96	3.91		13.78	0.57	0.28	12.23	16.87	14.91	12.91	12.80
Iurco	Iurco	13.99	A TR 200 3h	15.70	0.00	15.94	0.00					12.23	16.28	14.74	12.17	11.88
Iurco	Iurco	13.99	A TR 30 1.5h	12.75	0.00	12.85	0.00					12.23	15.92	14.63	11.89	11.59
Iurco	Iurco	13.99	P TR 200 1.5h	20.74	0.00	20.88	0.00					12.23	16.87	14.91	12.36	11.83
Iurco	Iurco	13.99	P TR 200 3h	15.70	0.00	15.94	0.00					12.23	16.28	14.74	12.04	11.59
Iurco	Iurco	13.99	P TR 30 1.5h	12.75	0.00	12.85	0.00					12.23	15.92	14.63	11.89	11.59
Iurco	Iurco	11.99	A TR 200 1.5h	16.94	-3.85	20.69	-3.85		19.26	0.44	0.22	8.80	11.83	11.19	8.90	8.44
Iurco	Iurco	11.99	A TR 200 3h	15.94	0.00	16.25	0.00					8.80	11.77	11.15	8.73	8.45
Iurco	Iurco	11.99	A TR 30 1.5h	12.85	0.00	12.92	0.00					8.80	11.56	11.02	8.43	8.05
Iurco	Iurco	11.99	P TR 200 1.5h	20.88	0.00	20.84	0.00					8.80	12.07	11.35	8.90	8.43
Iurco	Iurco	11.99	P TR 200 3h	15.94	0.00	16.26	0.00					8.80	11.77	11.15	8.73	8.45
Iurco	Iurco	11.99	P TR 30 1.5h	12.85	0.00	12.92	0.00					8.80	11.56	11.02	8.42	8.04
Iurco	Iurco_valle	8.46	A TR 200 1.5h	47.37	3.90	47.85	3.90		86.85	0.45	0.32	4.57	6.27	5.69	5.20	4.77
Iurco	Iurco_valle	8.46	A TR 200 3h	49.13	4.95	49.37	4.95		88.19	0.53	0.37	4.57	6.31	5.72	5.26	4.82
Iurco	Iurco_valle	8.46	A TR 30 1.5h	31.53	0.00	31.88	0.00					4.57	5.82	5.37	4.50	4.21
Iurco	Iurco_valle	8.46	P TR 30 1.5h	31.53	0.00	31.88	0.00					4.57	5.82	5.37	4.50	4.21

Storage Area	Plan	W.S. Elev (m)	SA Min El (m)	Net Flux (m3/s)	SA Area (1000 m2)	SA Volume (1000 m3)
CR_1	A TR 200 1.5h	4.98	4.50	3.90	1.24	0.59
CR_1	A TR 200 3h	5.04	4.50	4.95	2.94	0.75
CR_1	A TR 30 1.5h	4.50	4.50	0.00	1.24	0.00
CR_1	P TR 30 1.5h	4.50	4.50	0.00	1.24	0.00
IU_1	A TR 200 1.5h	9.24	7.69	0.06	2.66	1.34
IU_1	A TR 200 3h	7.69	7.69	0.00	0.05	0.00
IU_1	A TR 30 1.5h	7.69	7.69	0.00	0.05	0.00
IU_1	P TR 200 1.5h	7.69	7.69	0.00	0.05	0.00
IU_1	P TR 200 3h	7.69	7.69	0.00	0.05	0.00
IU_1	P TR 30 1.5h	7.69	7.69	0.00	0.05	0.00

Torrente Tripesce

Stato Attuale



None of the XS's are Geo-Referenced (Geo-Ref user entered XS, Geo-Ref interpolated XS, Non Geo-Ref user entered XS, Non Geo-Ref interpolated XS)
 1 cm Horiz. = 108 m 1 cm Vert. = 88 m

N.B. in grigio sono indicati gli sfioratori laterali in destra idrografica

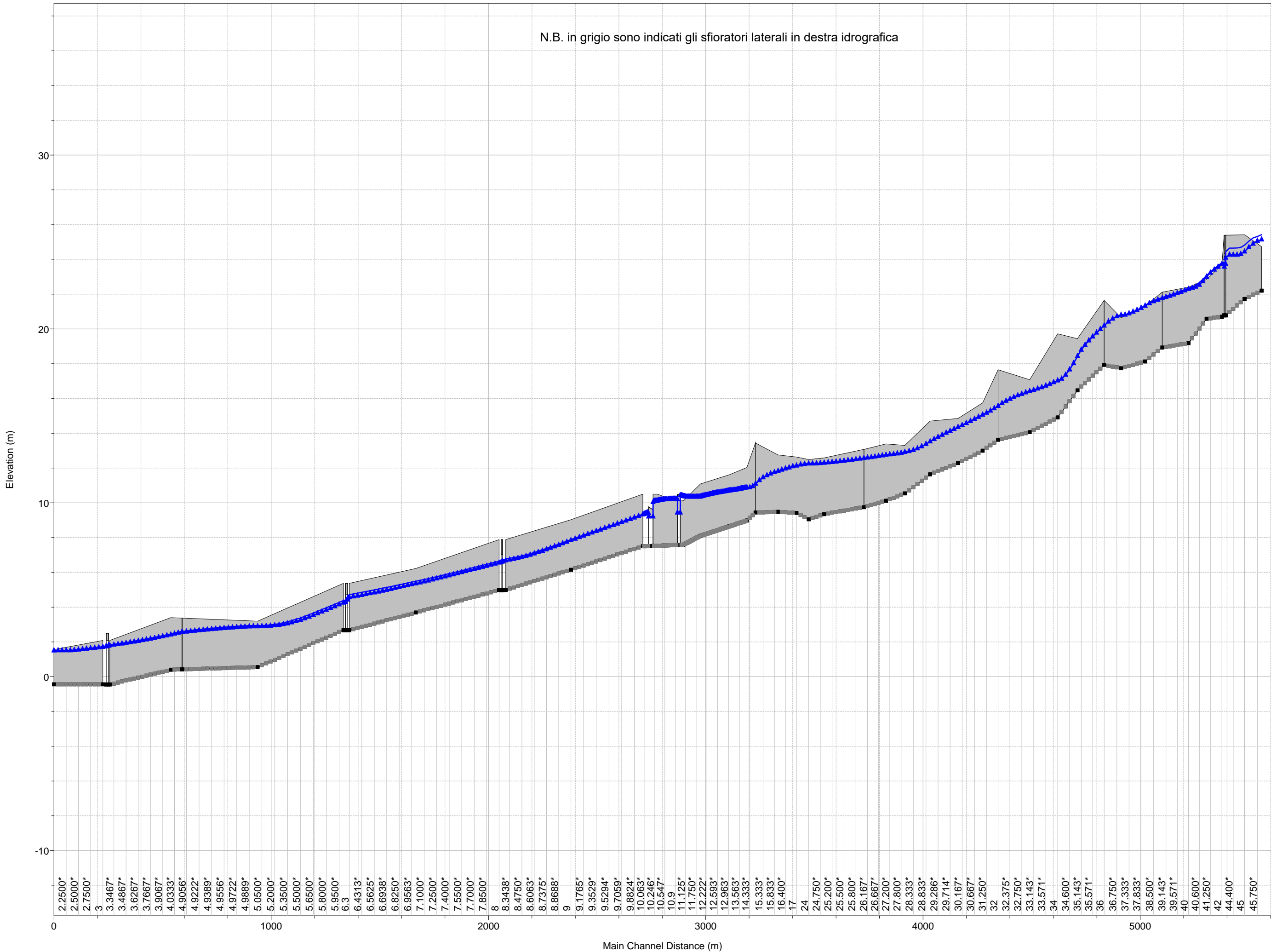
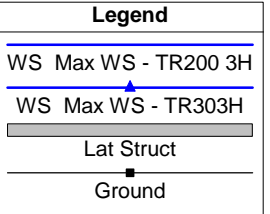

N.B. in grigio sono indicati gli sfioratori laterali in sinistra idrografica

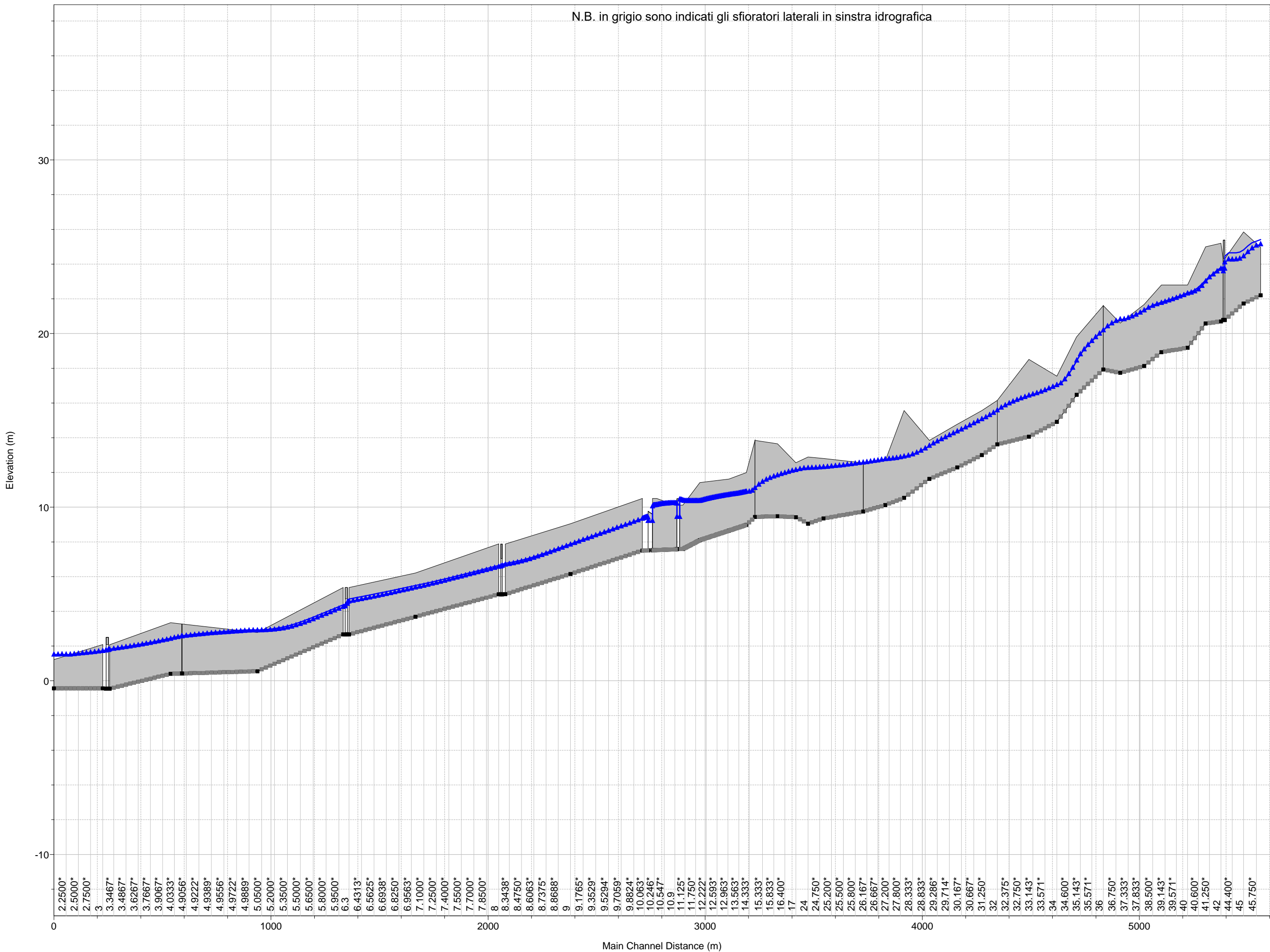
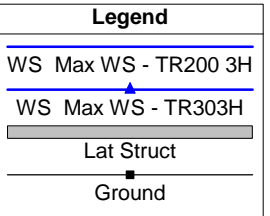

1 cm Horiz. = 160 m 1 cm Vert. = 2 m

Tripesce Plan: 1) TR200 3H 1/8/19 2) TR303H 1/8/19
Sez. 46 new

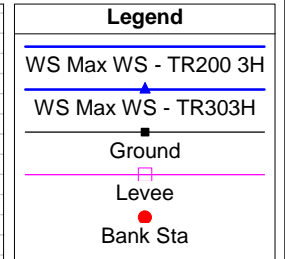
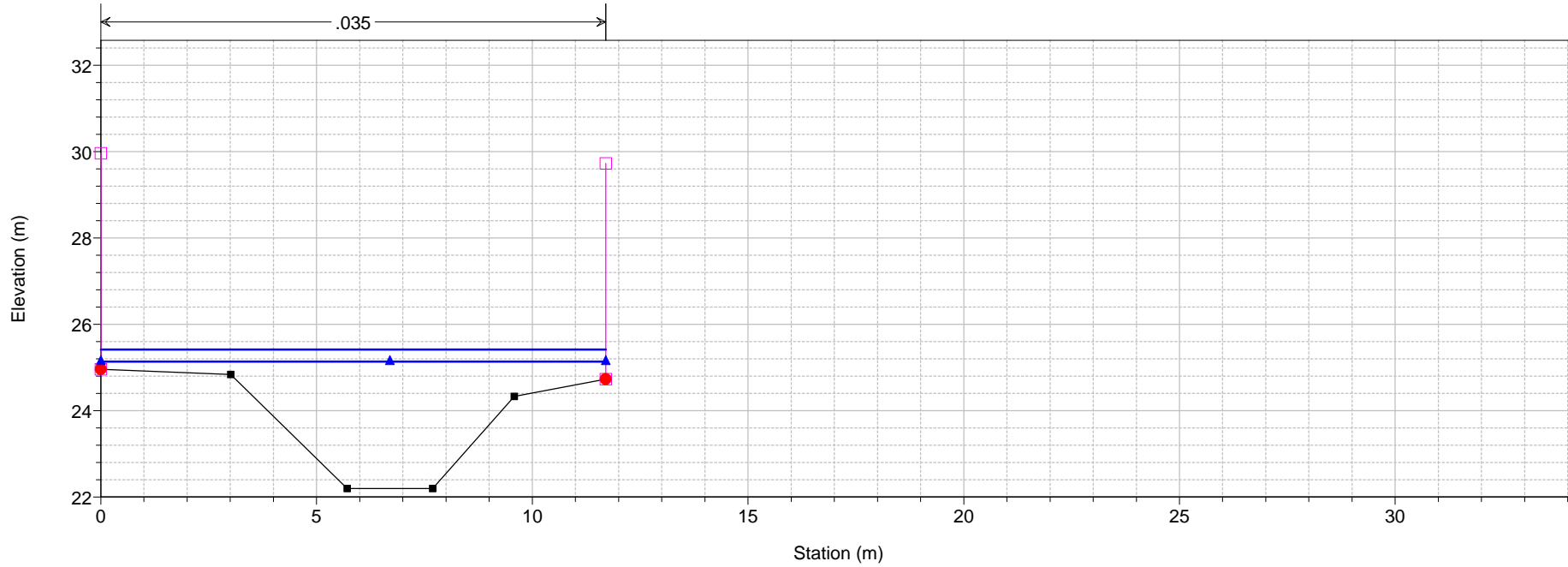

Tripesce Plan: 1) TR200 3H 1/8/19 2) TR303H 1/8/19
Sez. 45 new

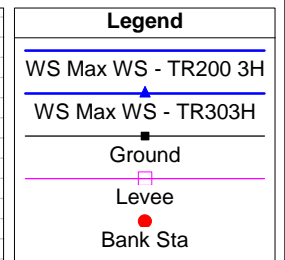
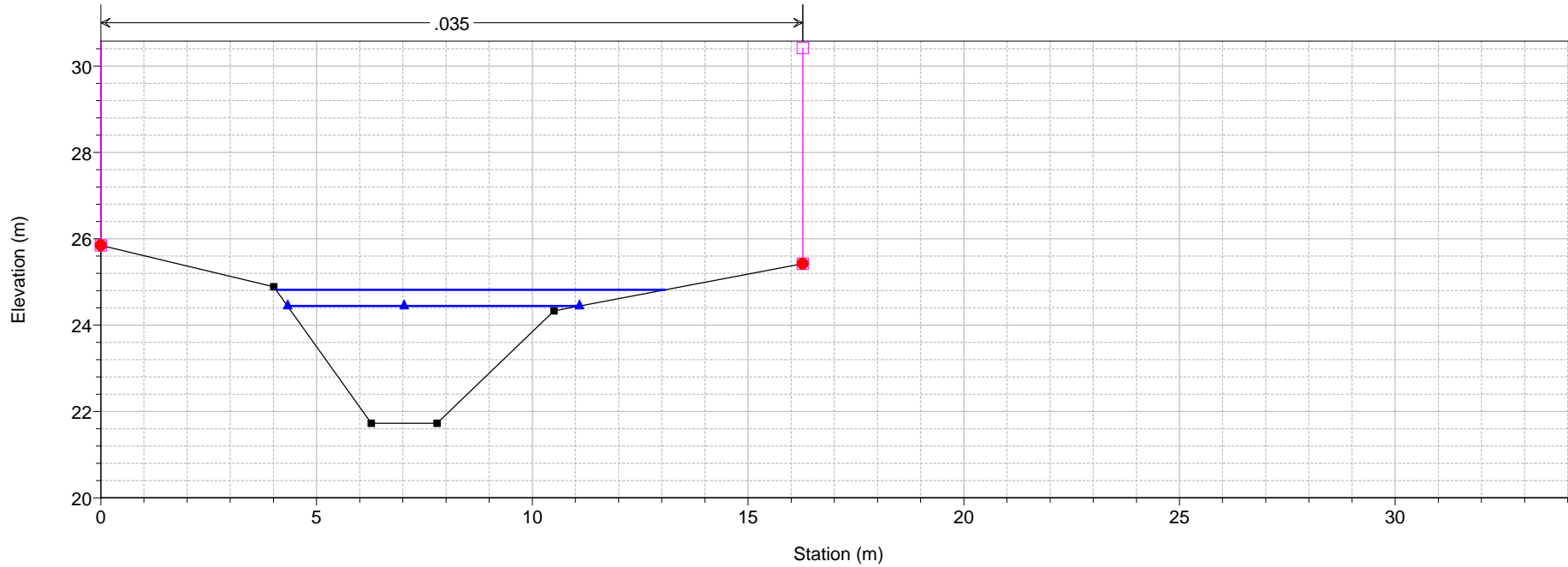

Tripesce Plan: 1) TR200 3H 1/8/19 2) TR303H 1/8/19
Sez. 44 new

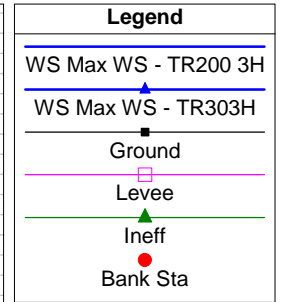
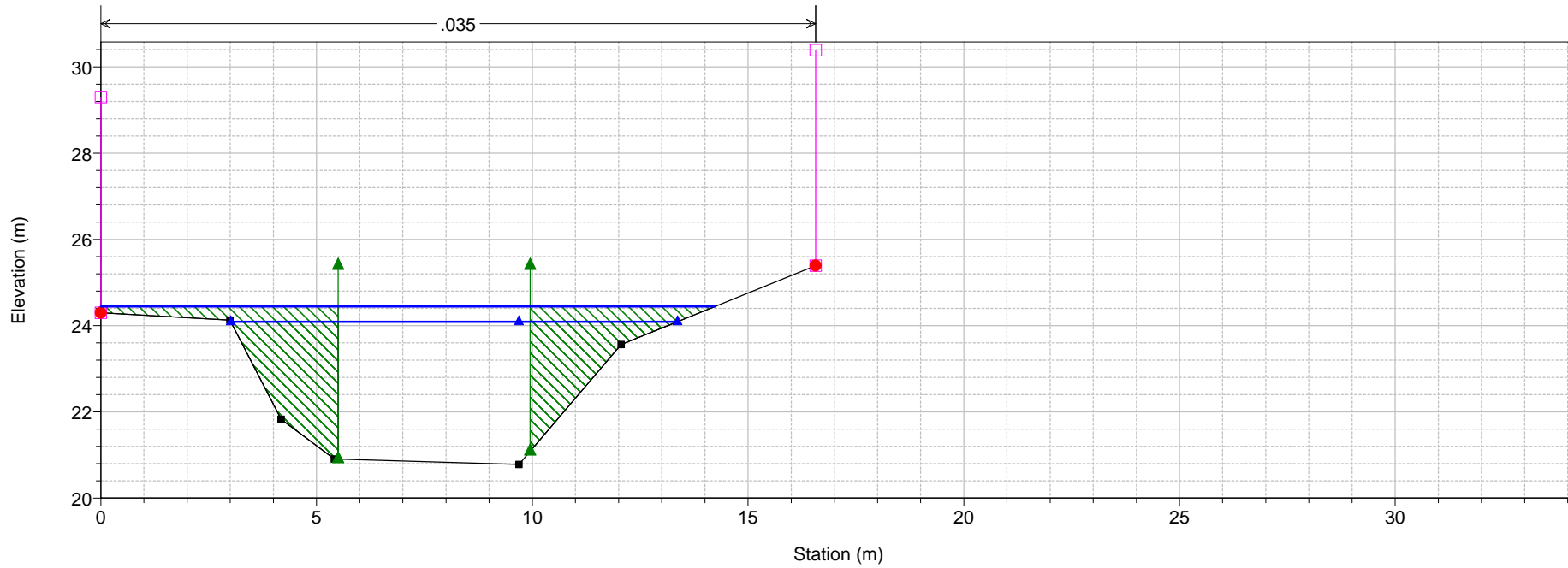

Tripesce Plan: 1) TR200 3H 1/8/19 2) TR303H 1/8/19

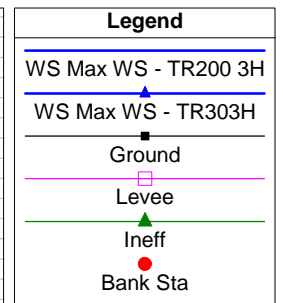
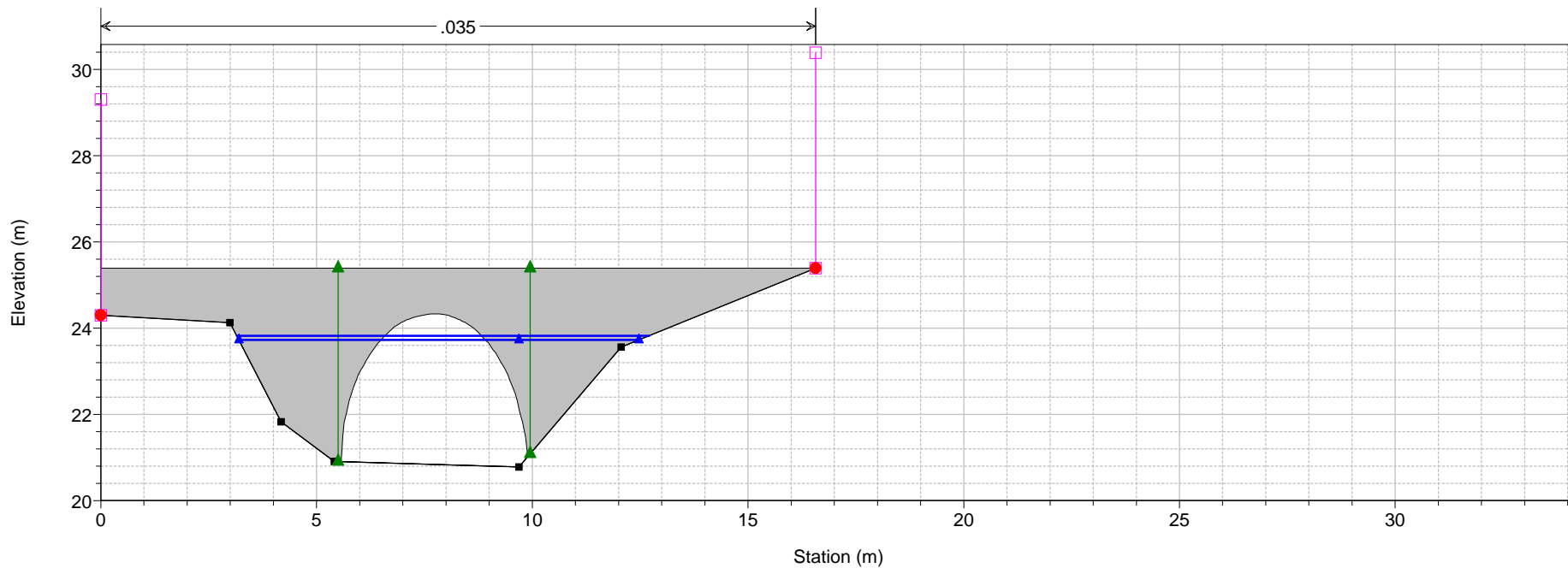

1 cm Horiz. = 1.5 m 1 cm Vert. = 1.5 m

Tripesce Plan: 1) TR200 3H 1/8/19 2) TR303H 1/8/19

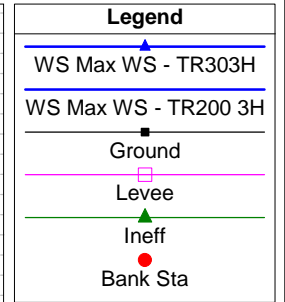
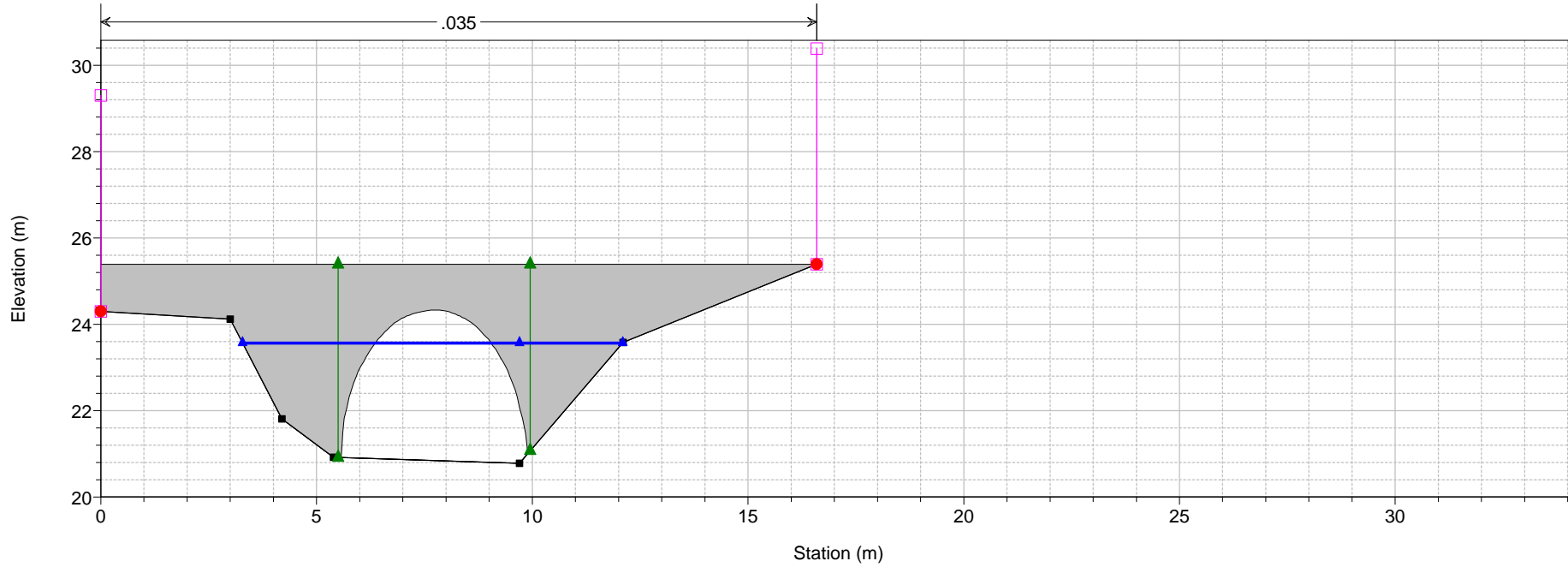

Tripesce Plan: 1) TR200 3H 1/8/19 2) TR303H 1/8/19
Sez. 43 new

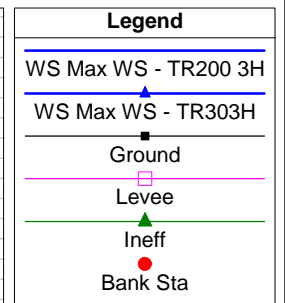
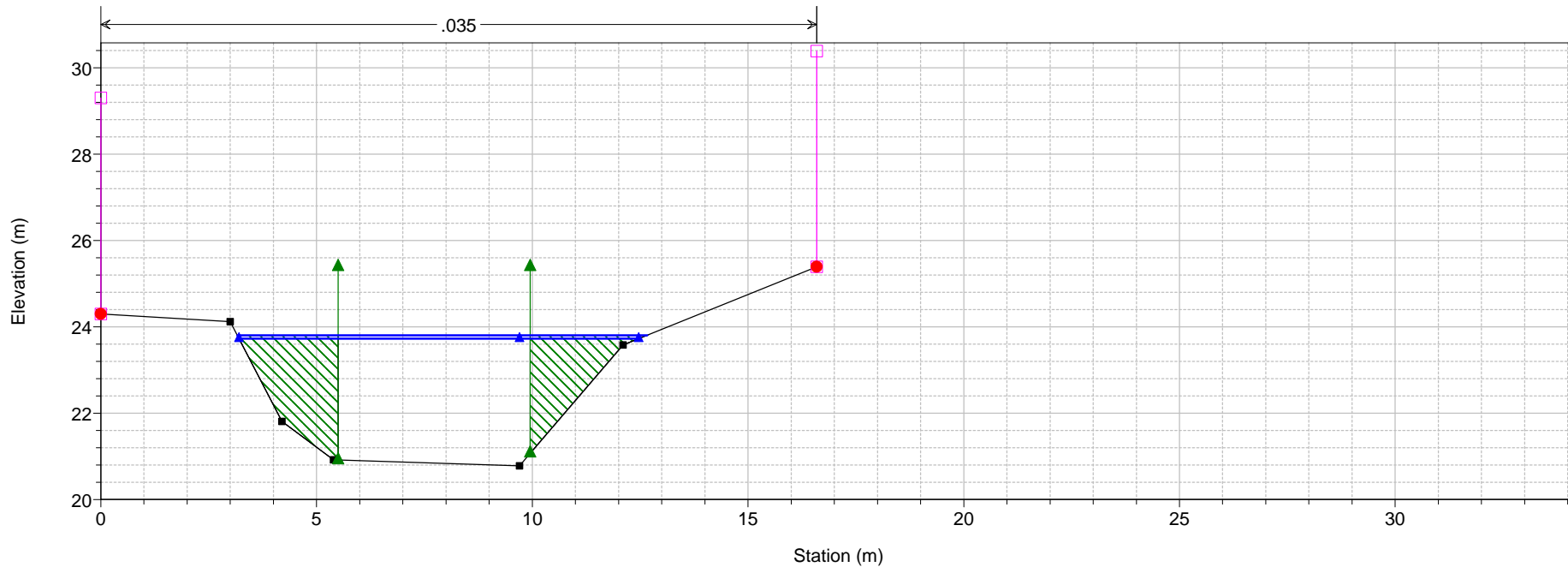

1 cm Horiz. = 1.5 m 1 cm Vert. = 1.5 m

Tripesce Plan: 1) TR200 3H 1/8/19 2) TR303H 1/8/19

Sez. 42 new

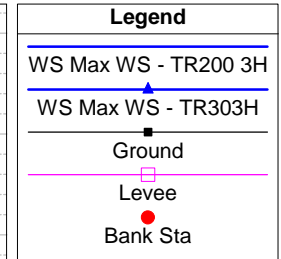
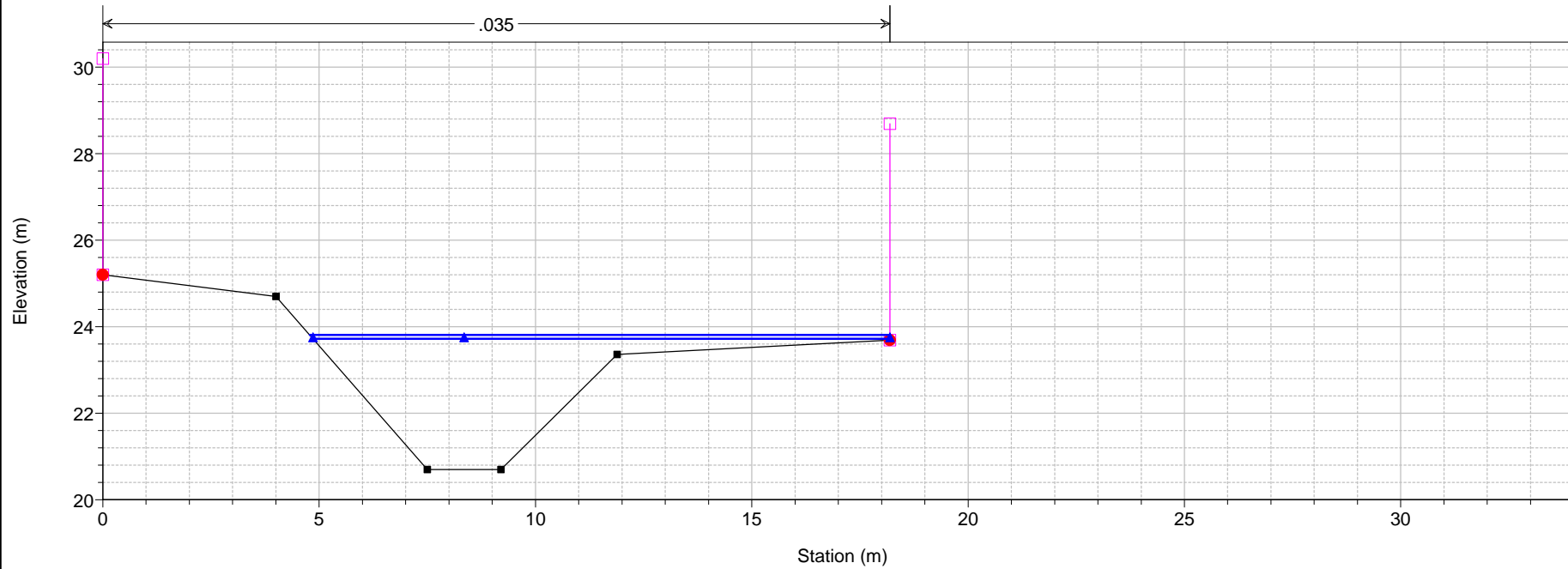

Tripesce Plan: 1) TR200 3H 1/8/19 2) TR303H 1/8/19

Sez. 41 new

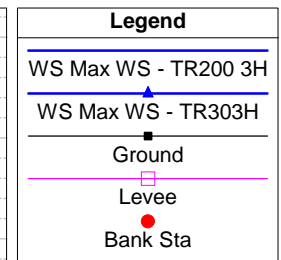
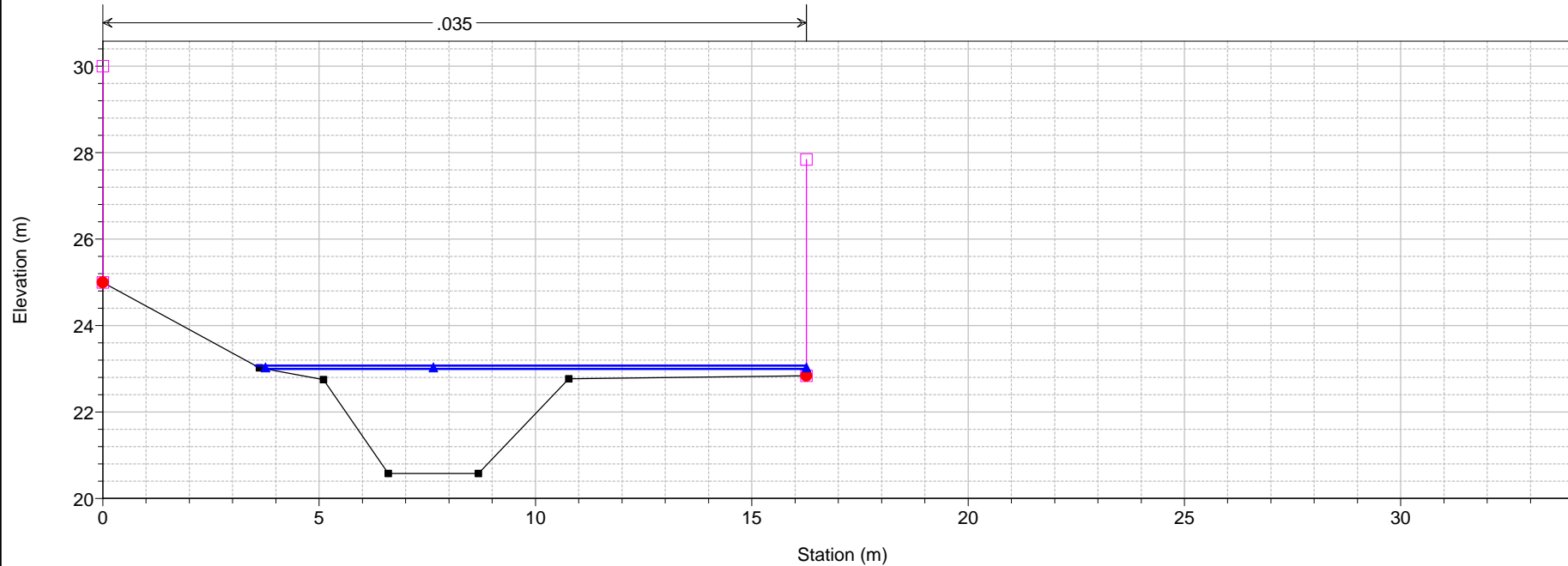

Tripesce Plan: 1) TR200 3H 1/8/19 2) TR303H 1/8/19
Sez. 40 new

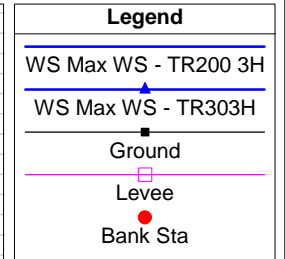
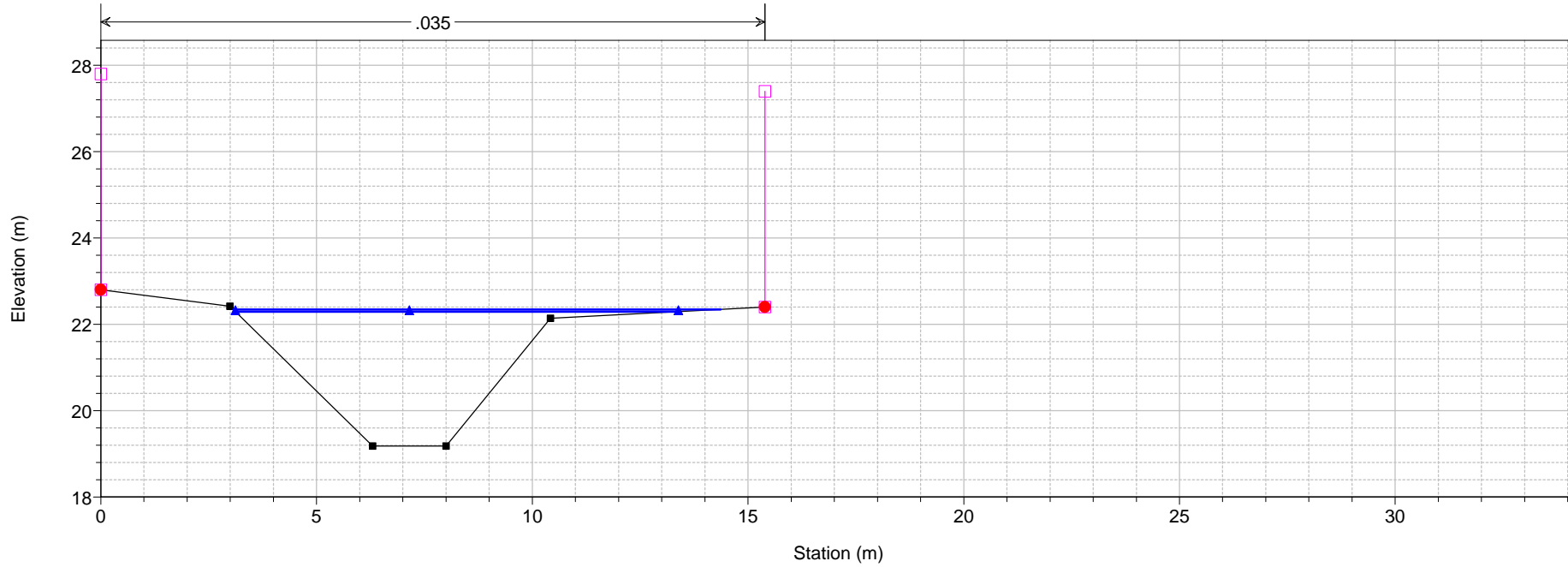

Tripesce Plan: 1) TR200 3H 1/8/19 2) TR303H 1/8/19
Sez. 39 new

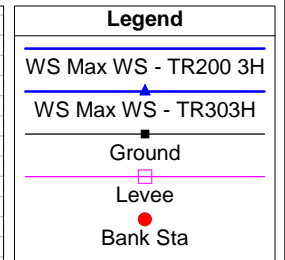
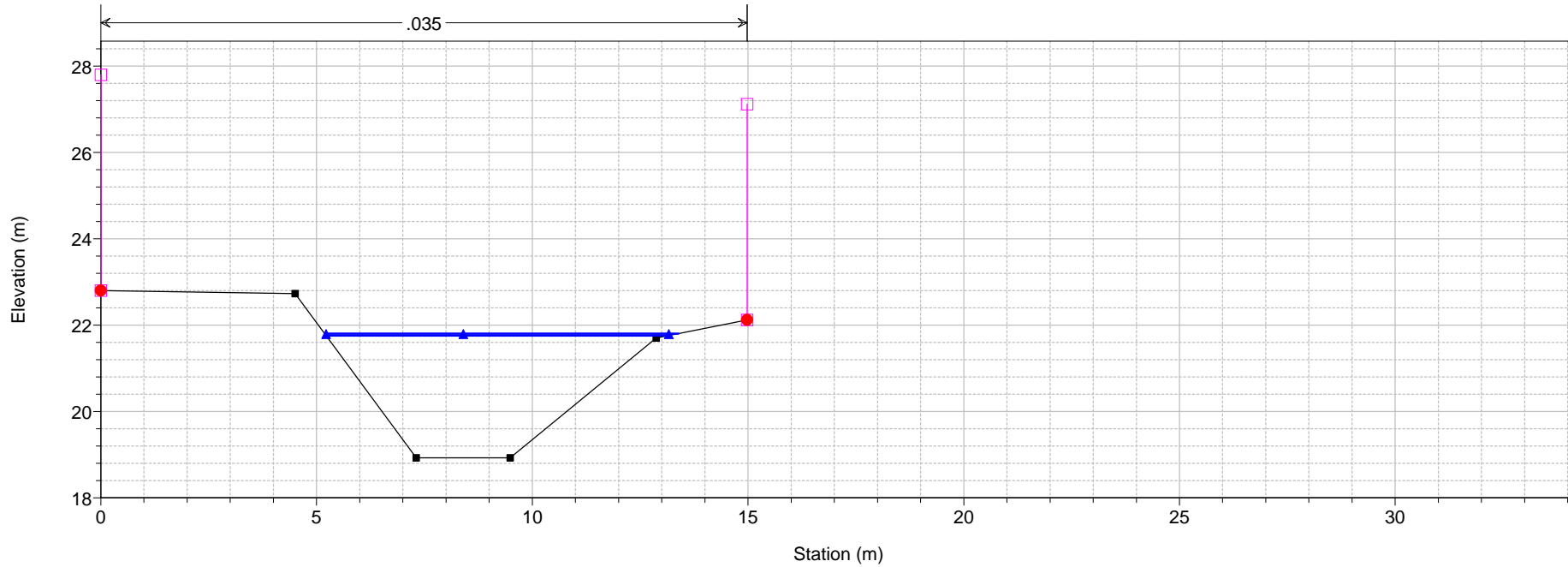

Tripesce Plan: 1) TR200 3H 1/8/19 2) TR303H 1/8/19
Sez. 38 new

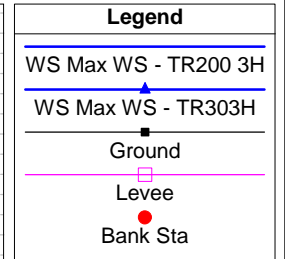
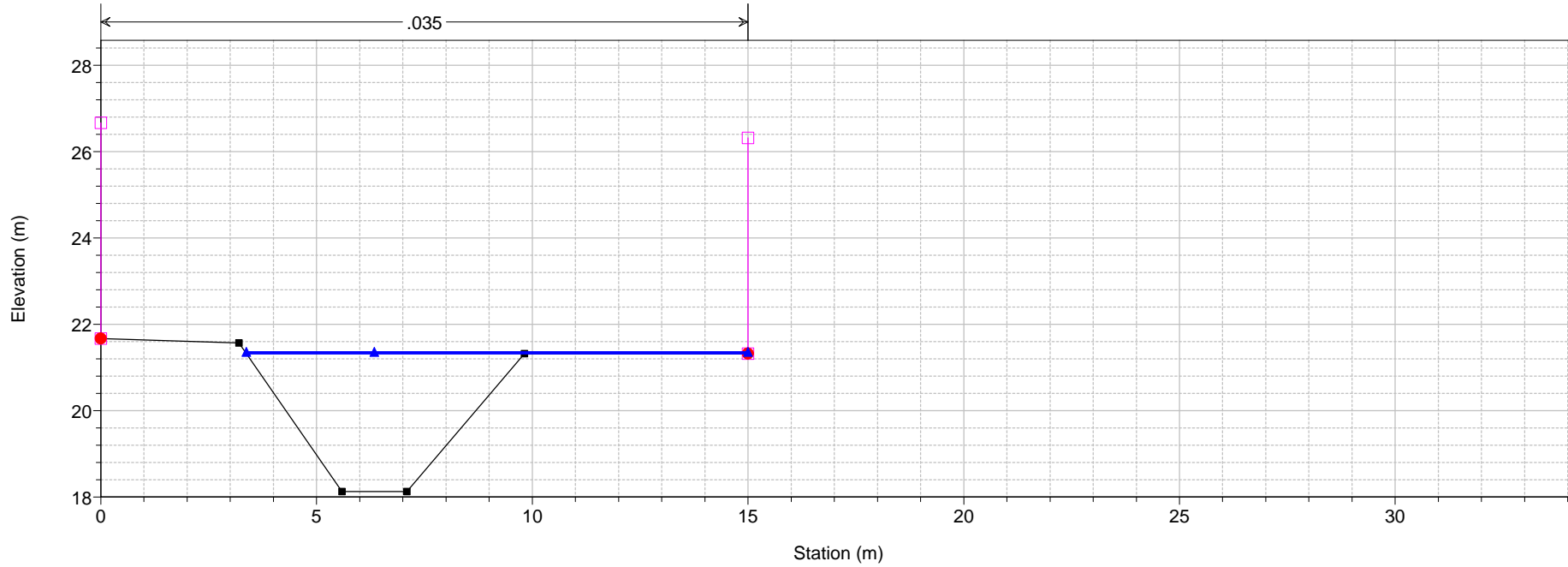

Tripesce Plan: 1) TR200 3H 1/8/19 2) TR303H 1/8/19
Sez. 37 new

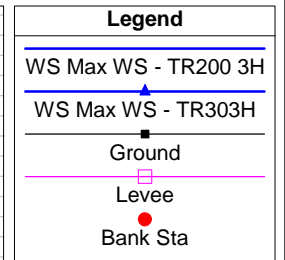
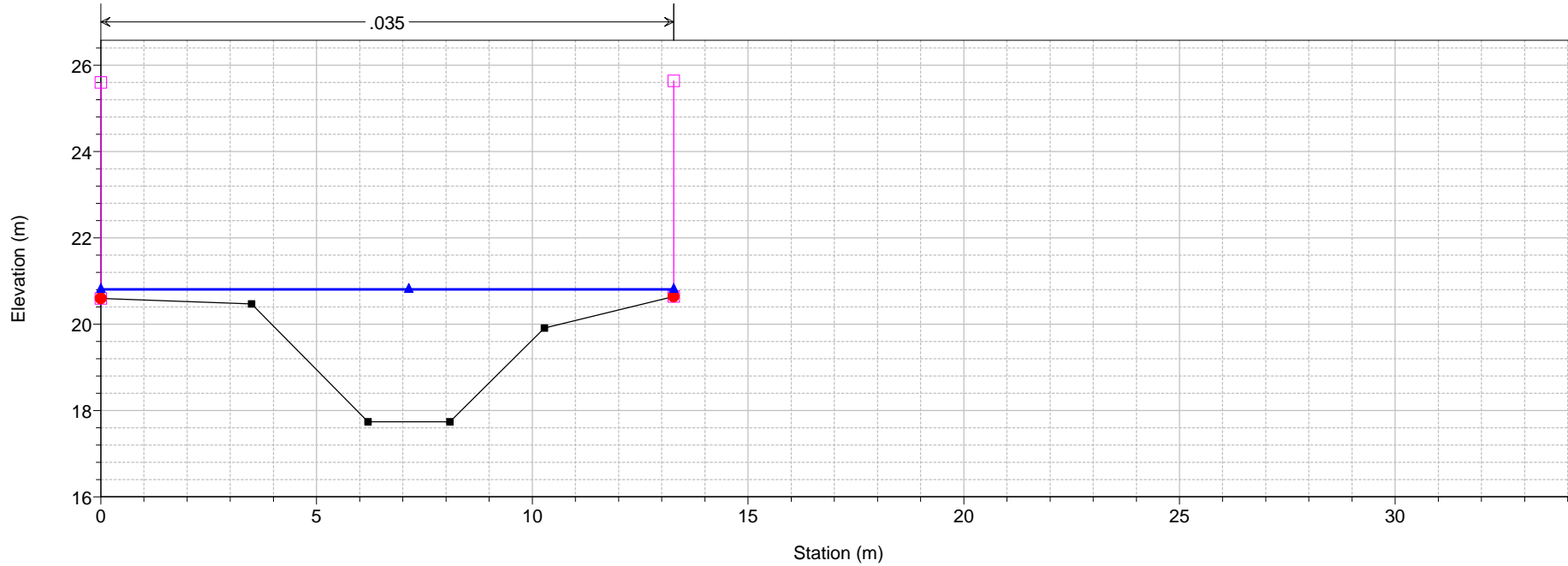

Tripesce Plan: 1) TR200 3H 1/8/19 2) TR303H 1/8/19
Sez. 36 new

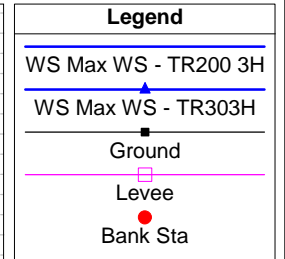
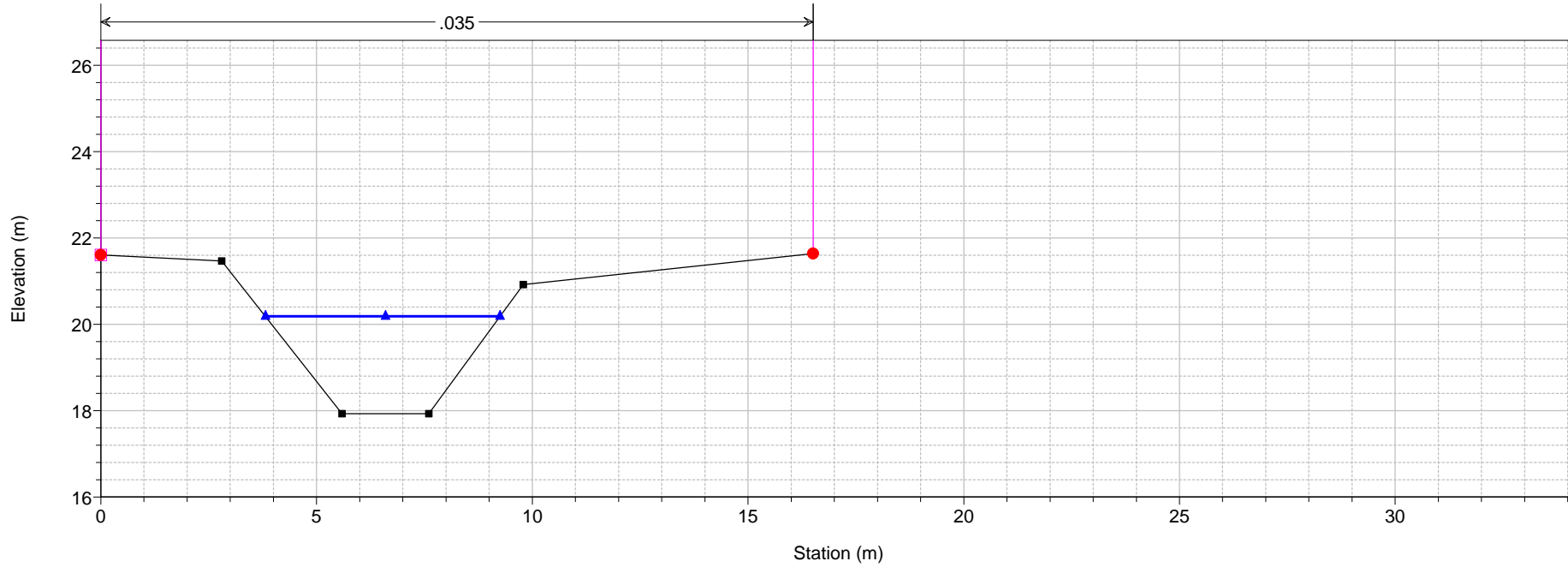

Tripesce Plan: 1) TR200 3H 1/8/19 2) TR303H 1/8/19
Sez. 35 new

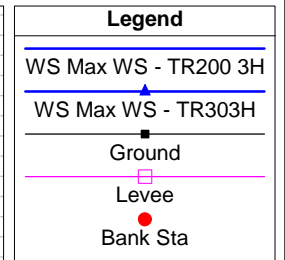
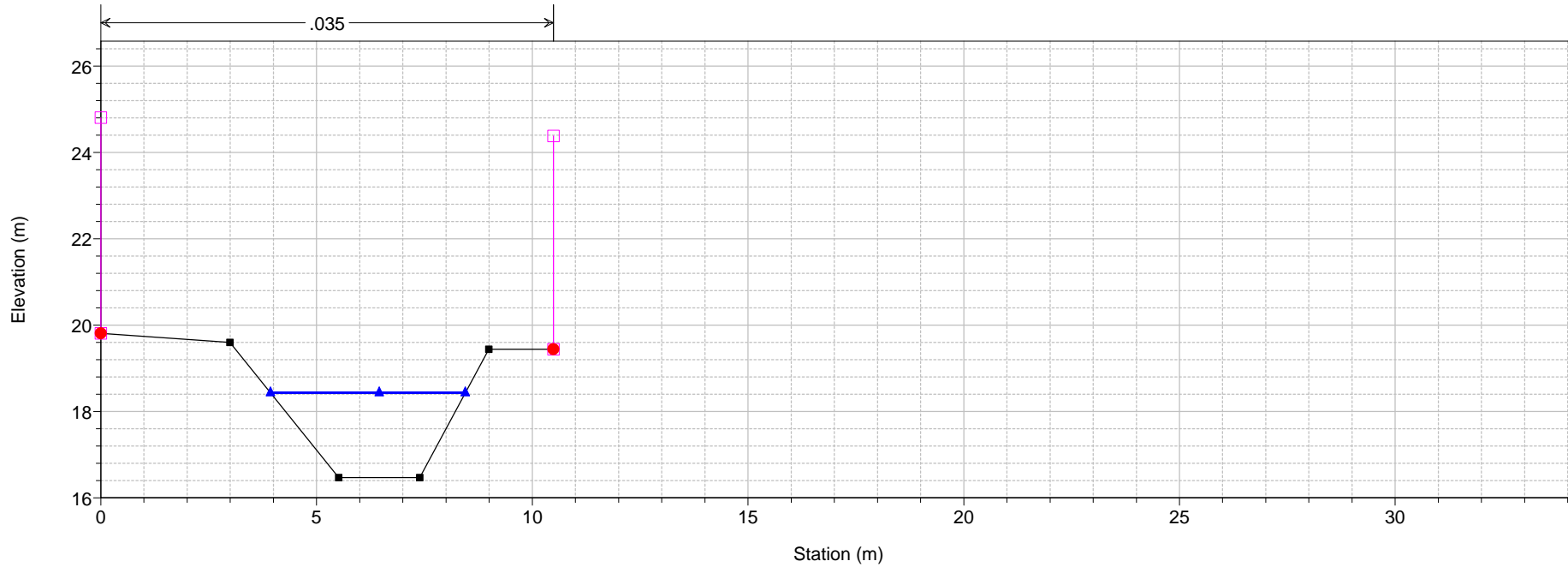

Tripesce Plan: 1) TR200 3H 1/8/19 2) TR303H 1/8/19
Sez. 34 new

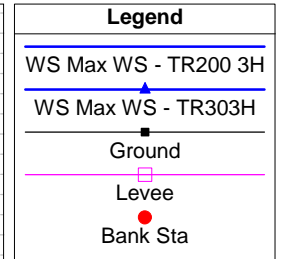
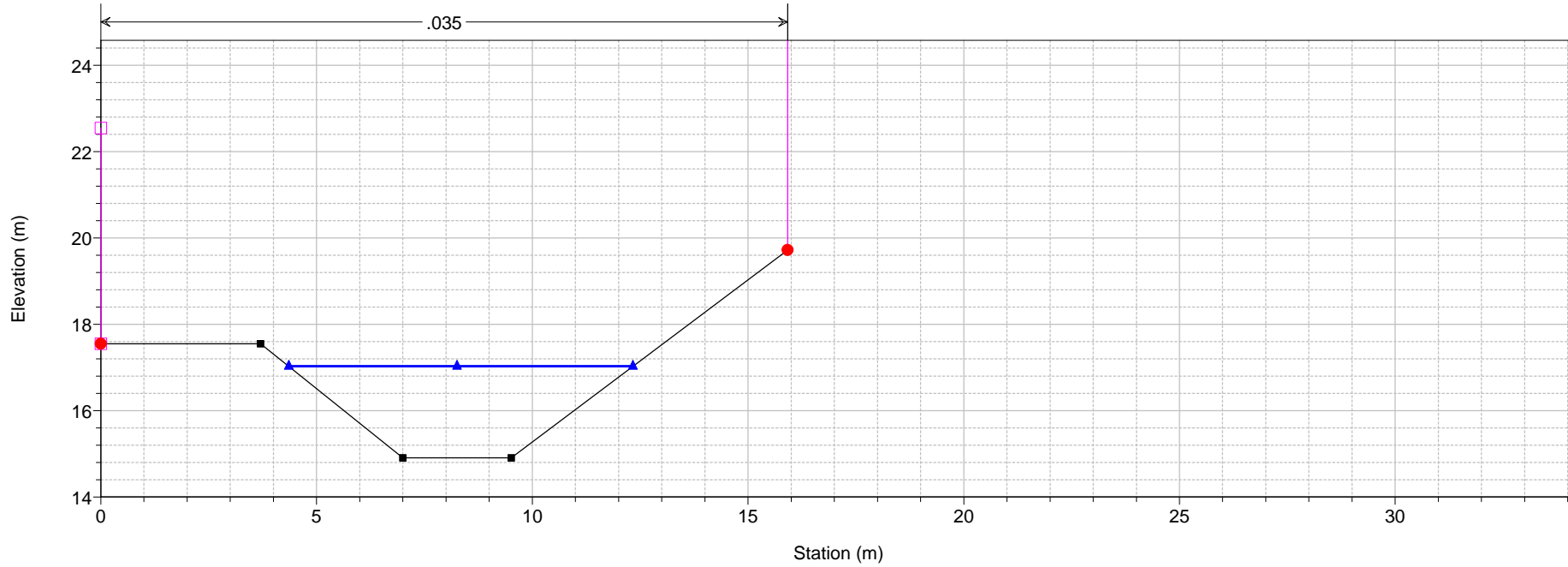

Tripesce Plan: 1) TR200 3H 1/8/19 2) TR303H 1/8/19
Sez. 33 new

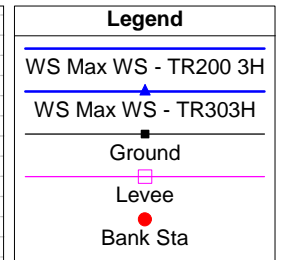
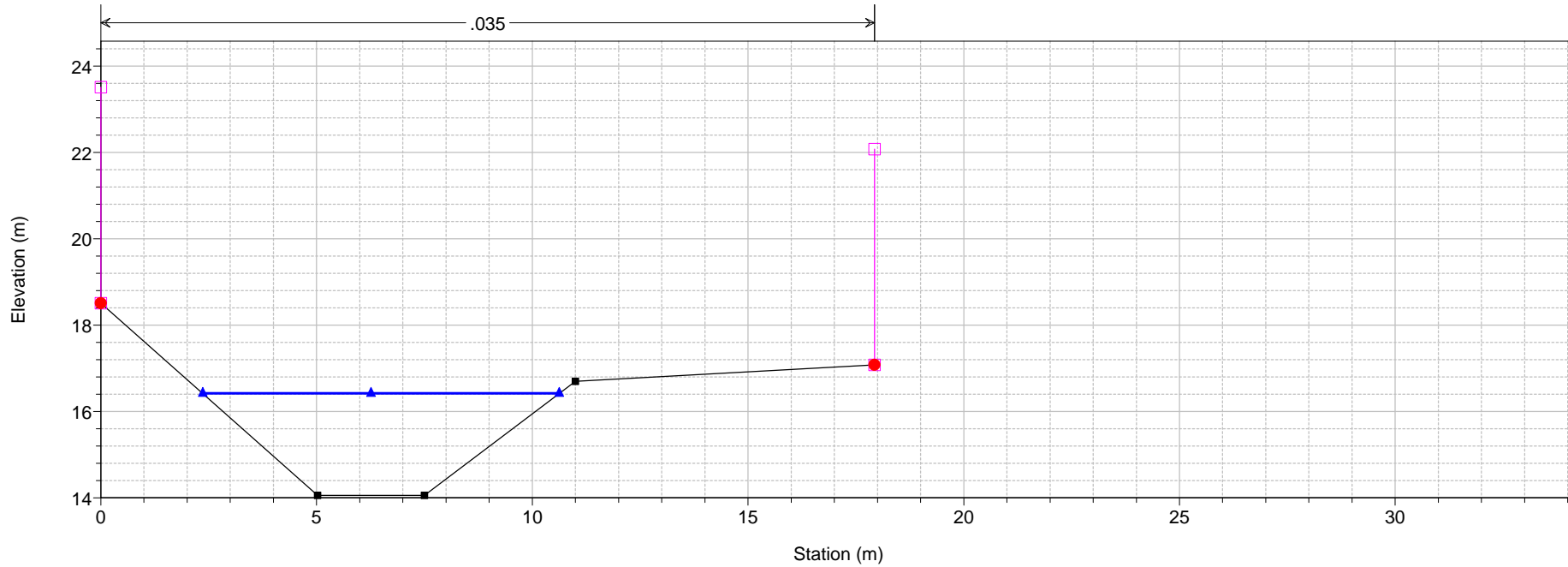

Tripesce Plan: 1) TR200 3H 1/8/19 2) TR303H 1/8/19
Sez. 32 new

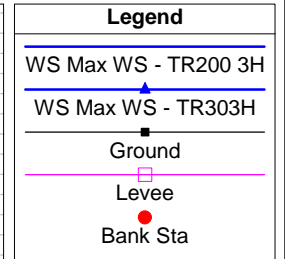
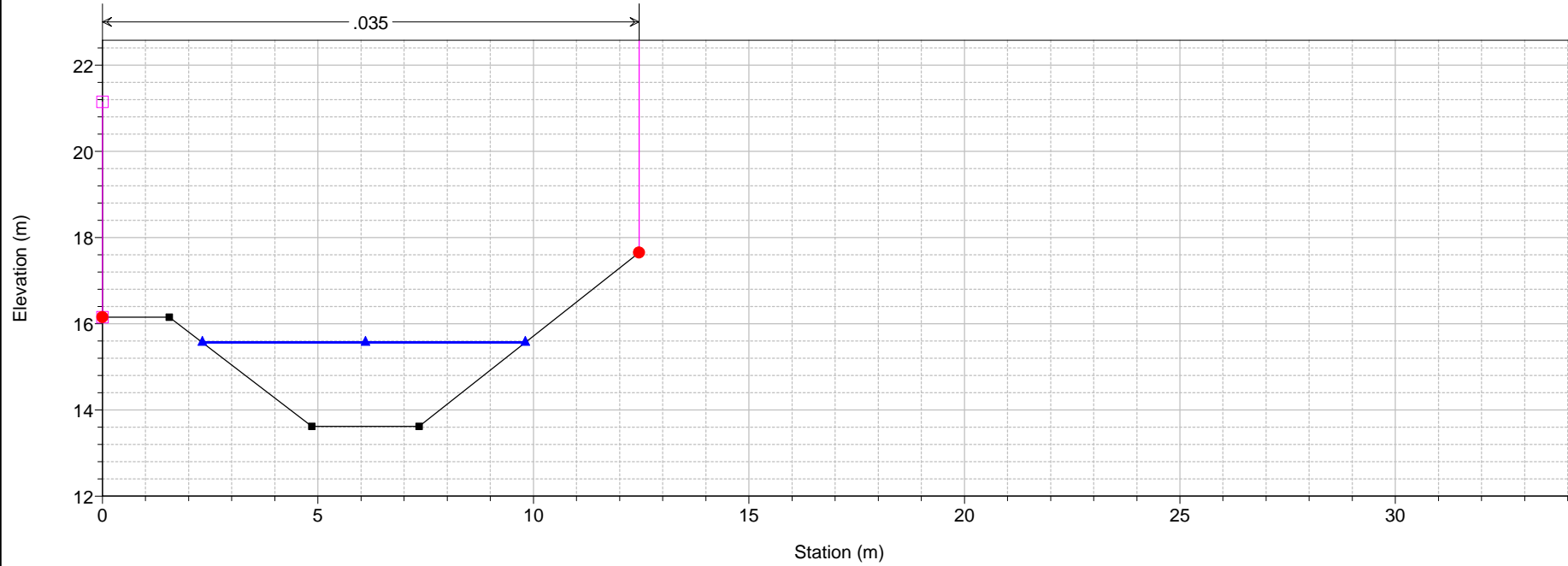

Tripesce Plan: 1) TR200 3H 1/8/19 2) TR303H 1/8/19
Sez. 31 new

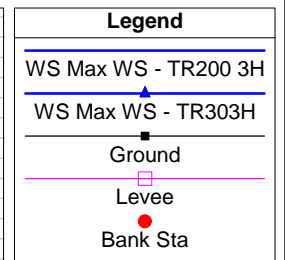
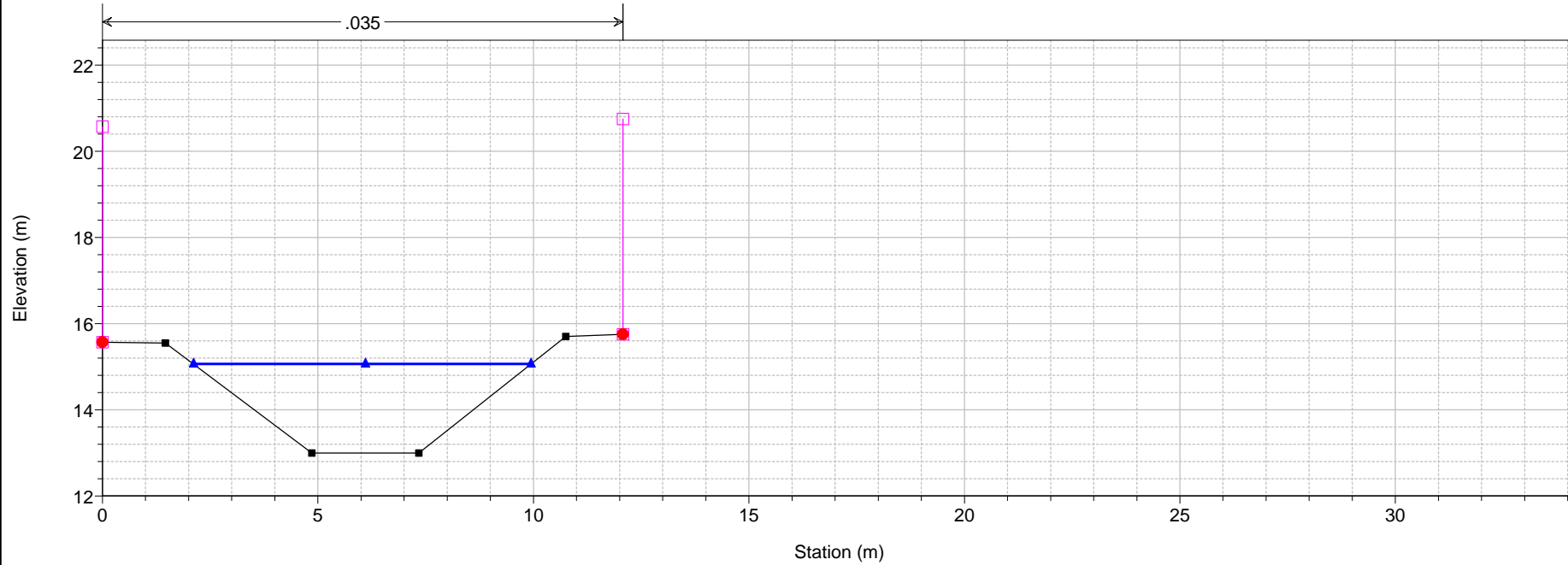

Tripesce Plan: 1) TR200 3H 1/8/19 2) TR303H 1/8/19
Sez. 30 new

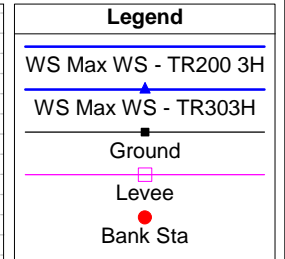
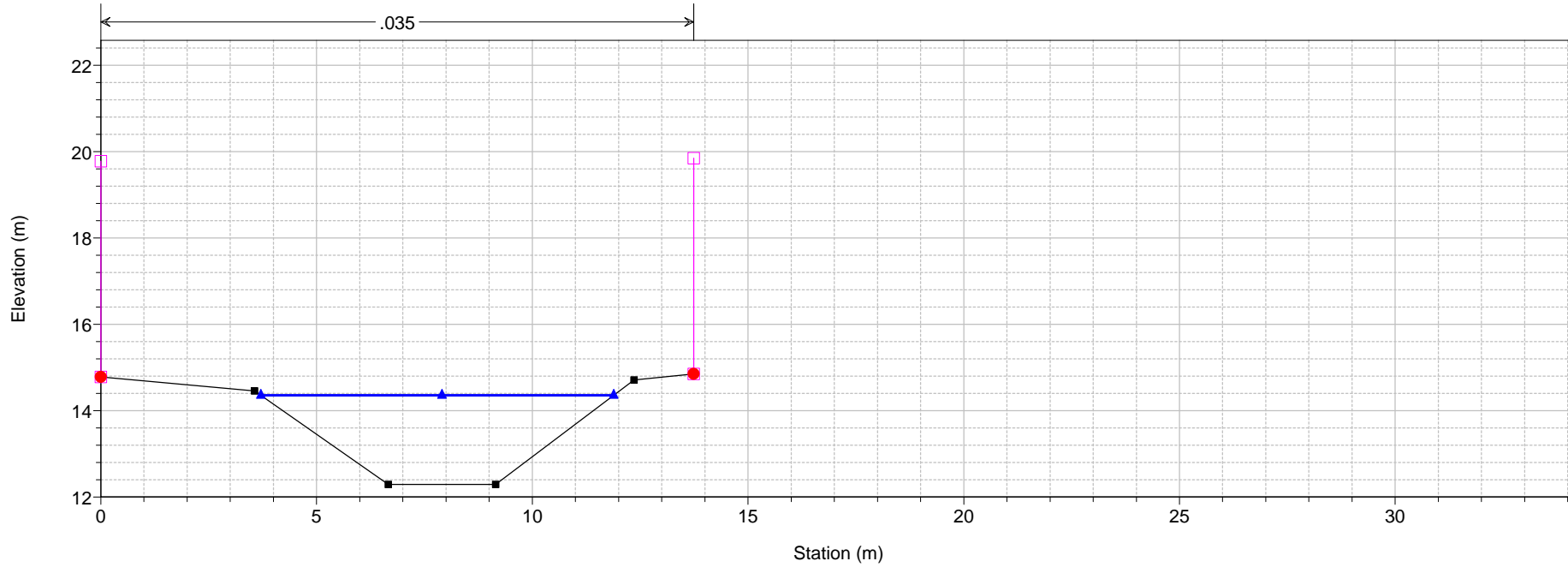

Tripesce Plan: 1) TR200 3H 1/8/19 2) TR303H 1/8/19
Sez. 29 new

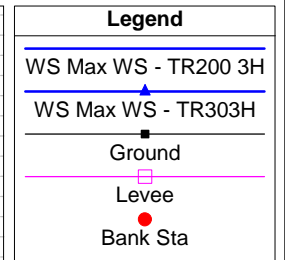
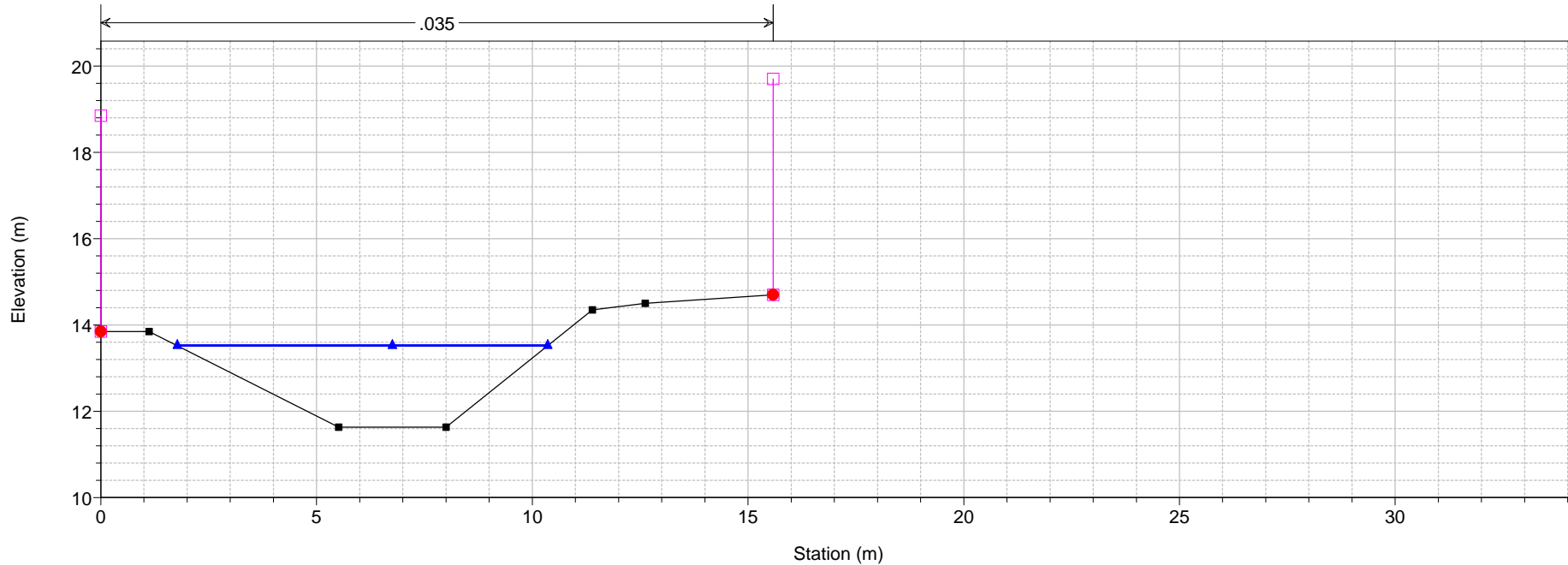

Tripesce Plan: 1) TR200 3H 1/8/19 2) TR303H 1/8/19
Sez. 28 new

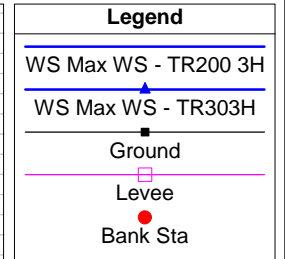
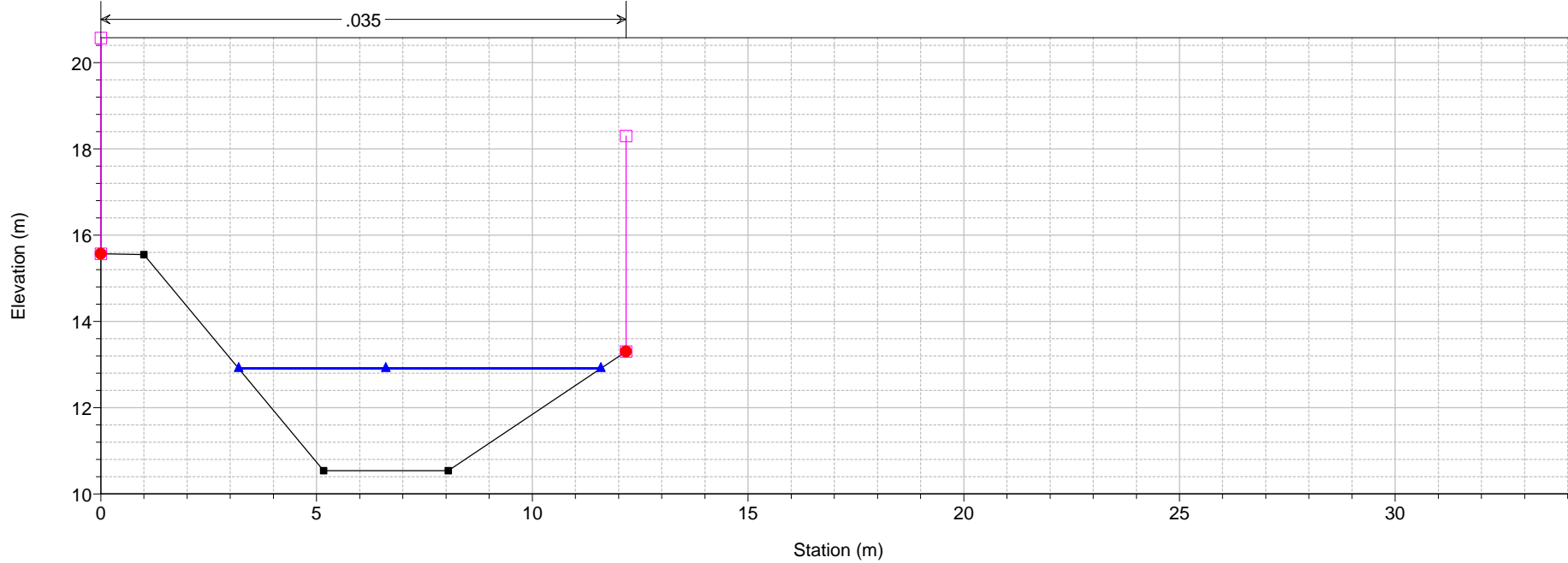

Tripesce Plan: 1) TR200 3H 1/8/19 2) TR303H 1/8/19
Sez. 27 new

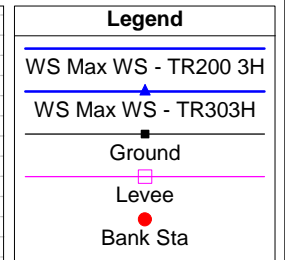
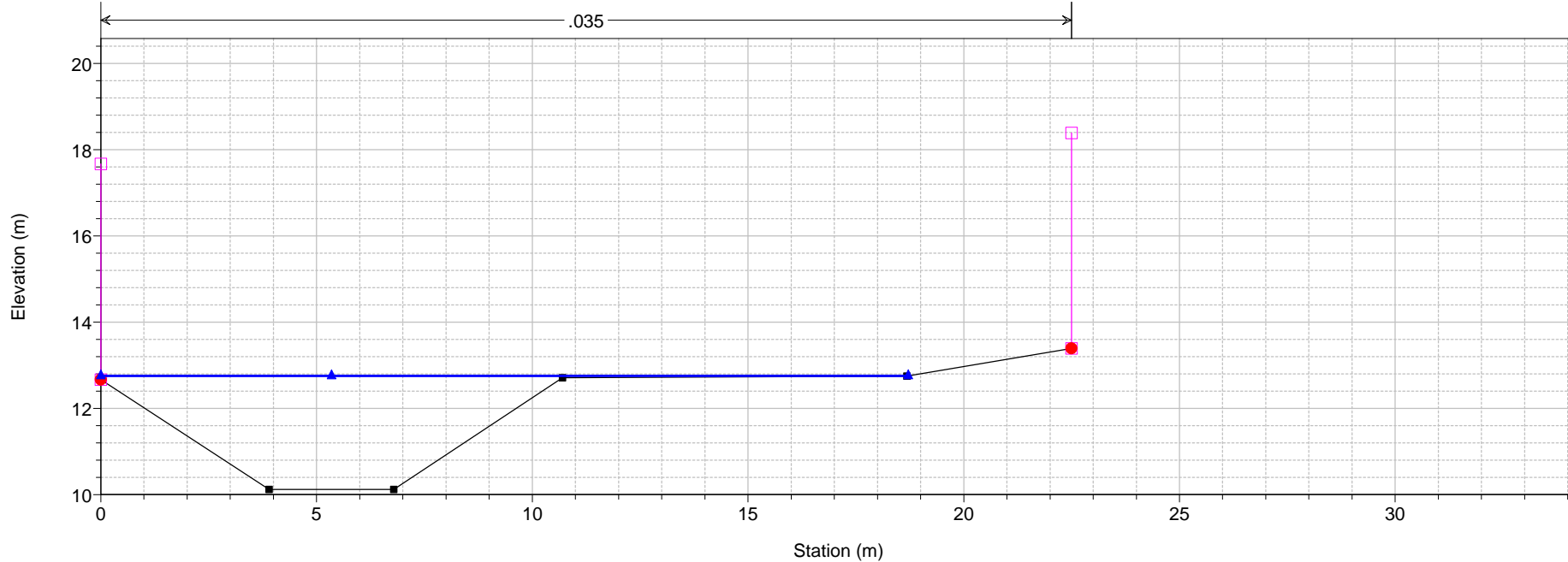

Tripesce Plan: 1) TR200 3H 1/8/19 2) TR303H 1/8/19
Sez. 26 new

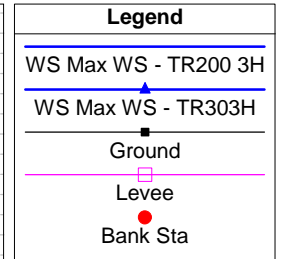
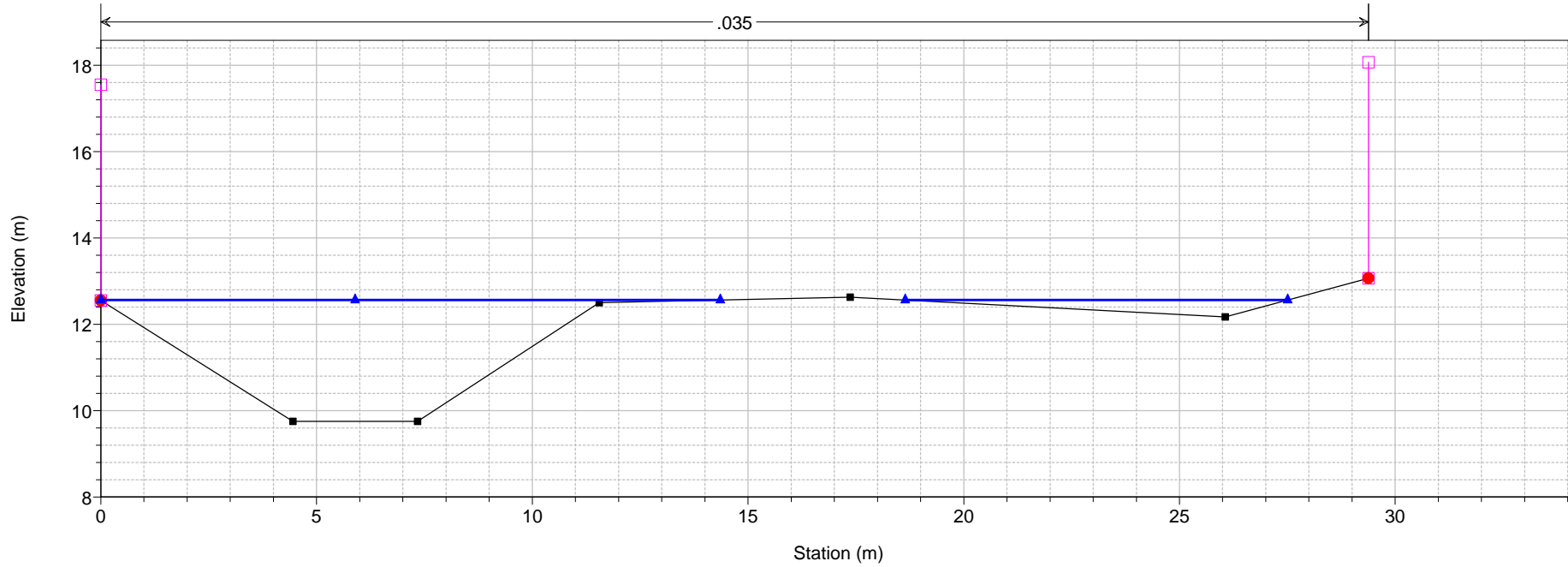

Tripesce Plan: 1) TR200 3H 1/8/19 2) TR303H 1/8/19
Sez. 25 new

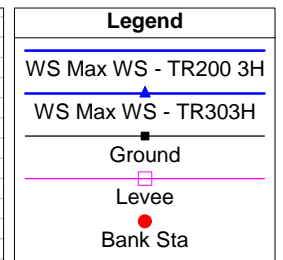
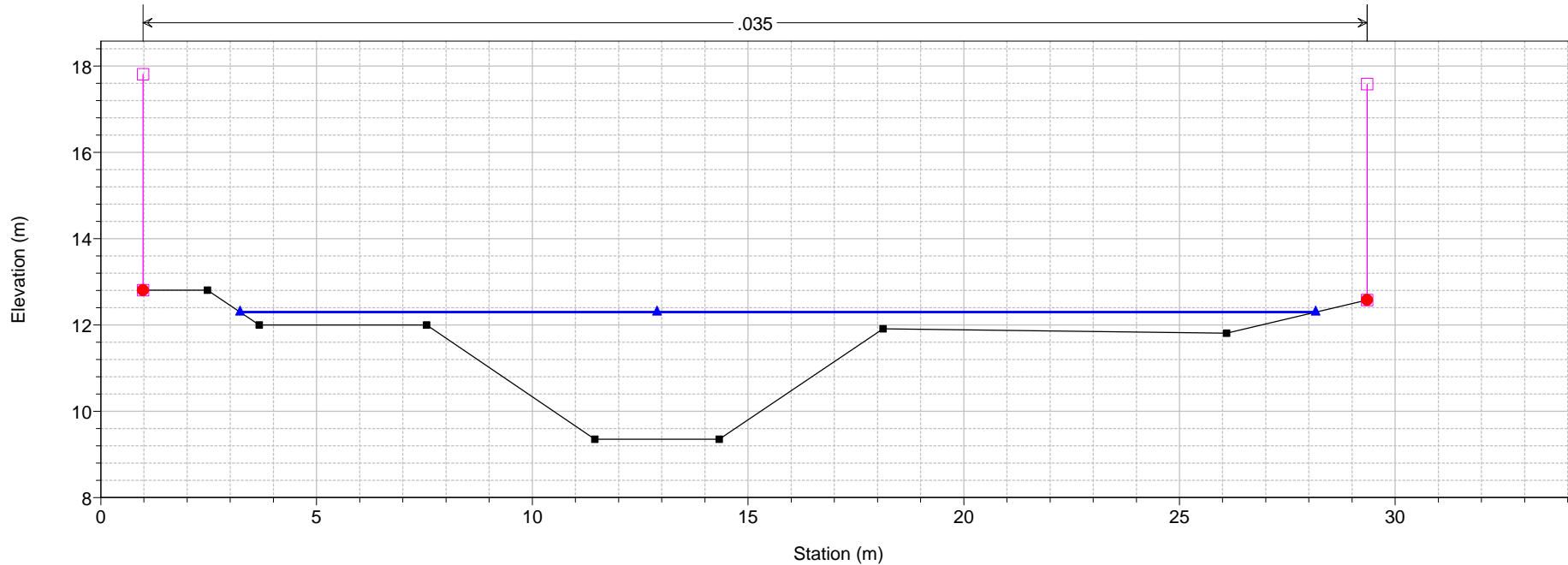

Tripesce Plan: 1) TR200 3H 1/8/19 2) TR303H 1/8/19
Sez. 24 new

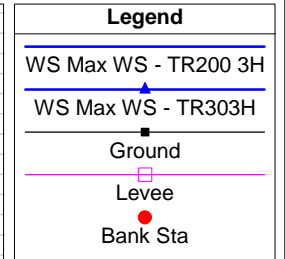
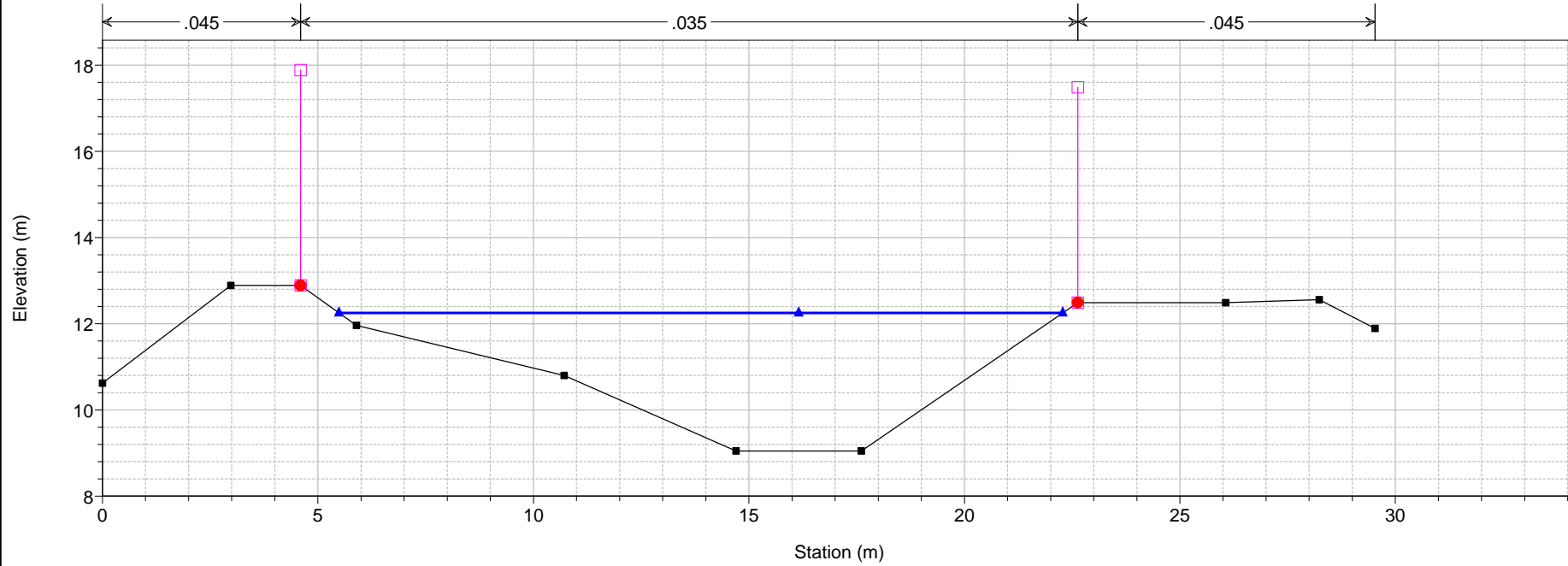

Tripesce Plan: 1) TR200 3H 1/8/19 2) TR303H 1/8/19
Sez. 17 new

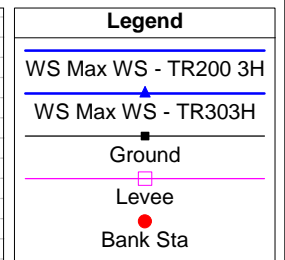
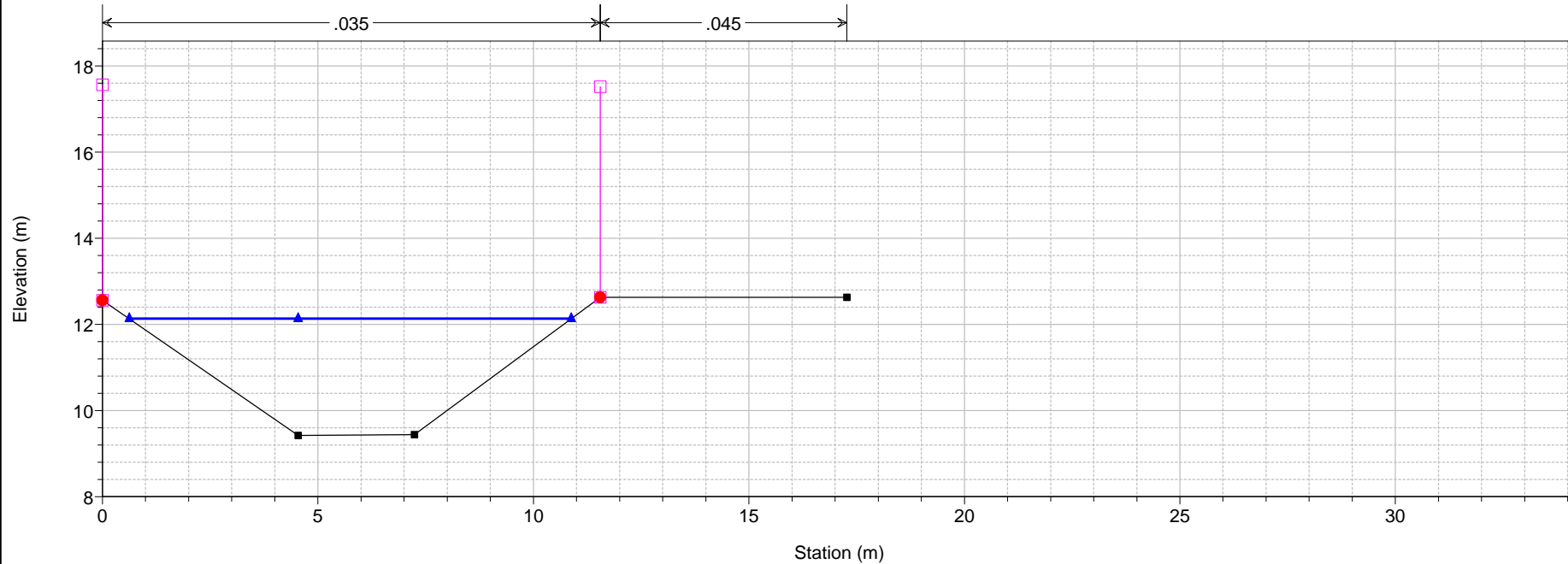

Tripesce Plan: 1) TR200 3H 1/8/19 2) TR303H 1/8/19

Sez. 16 new

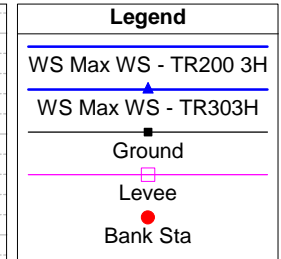
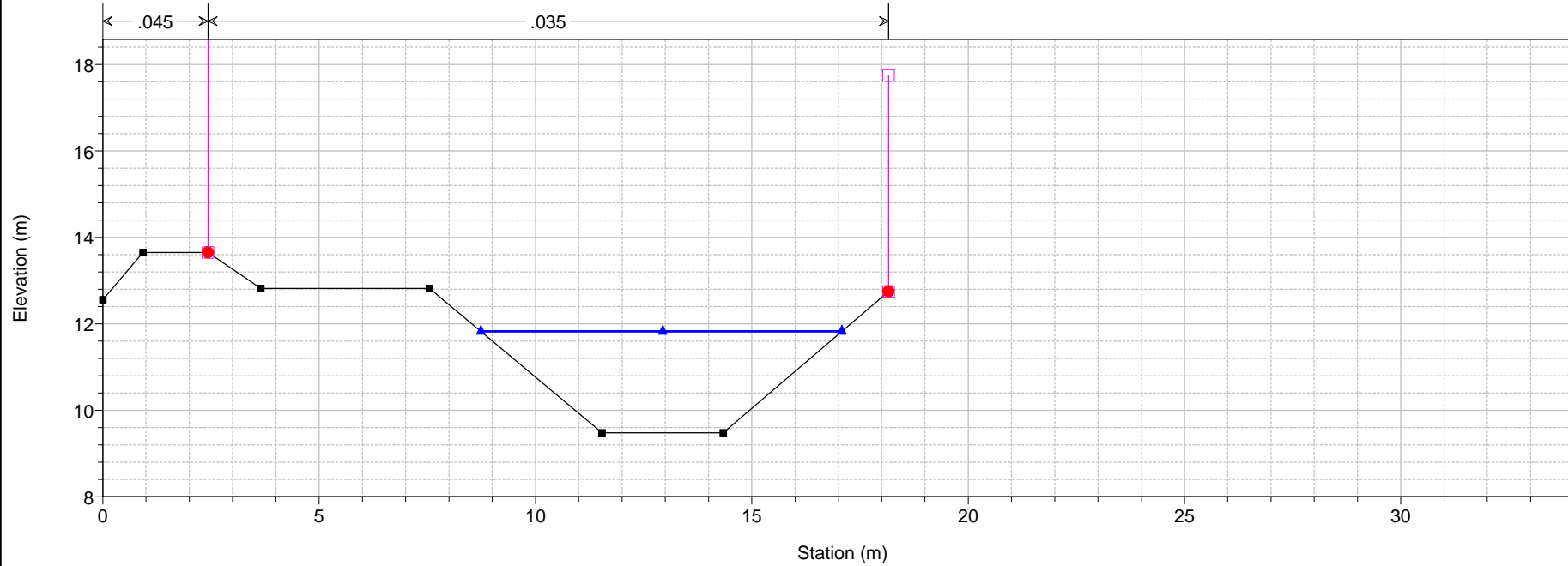

Tripesce Plan: 1) TR200 3H 1/8/19 2) TR303H 1/8/19

Sez. 15 new

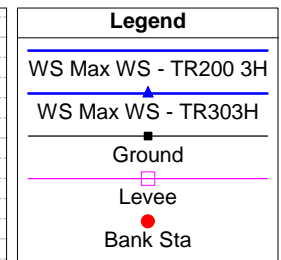
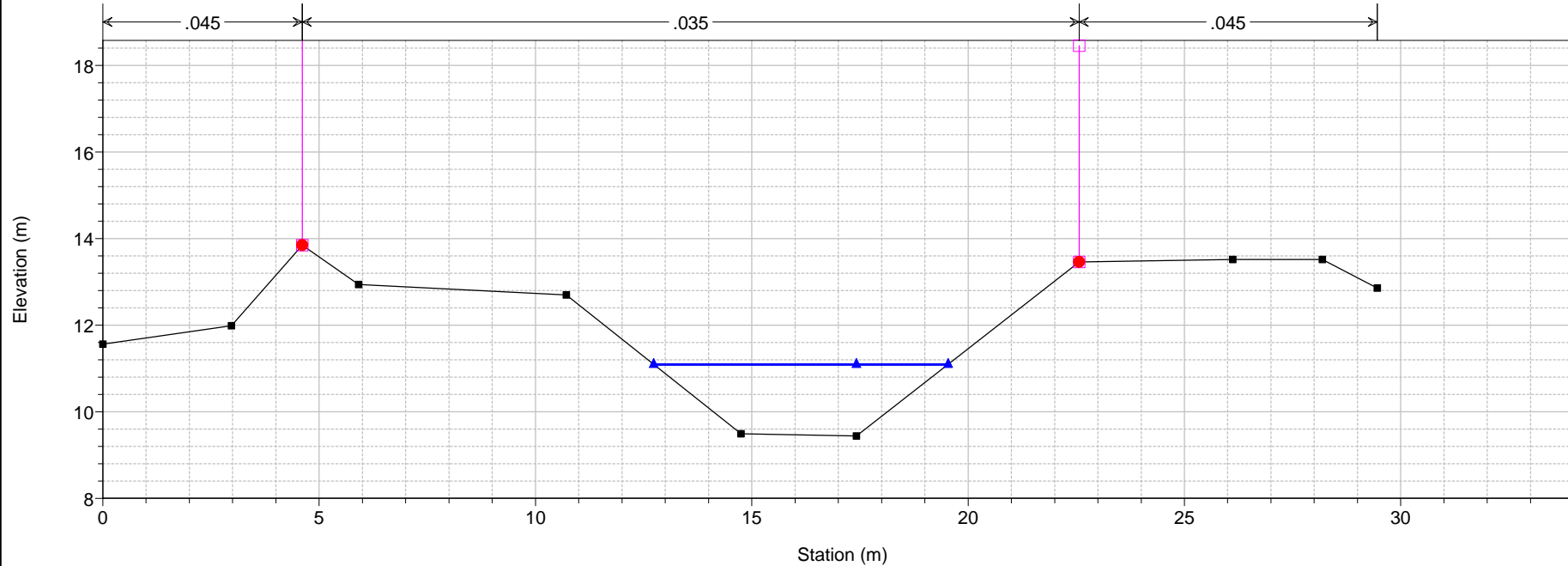

Tripesce Plan: 1) TR200 3H 1/8/19 2) TR303H 1/8/19
Sez. 14 new

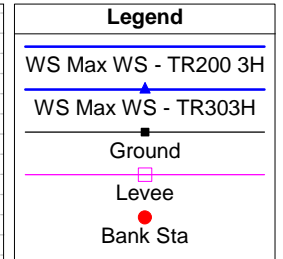
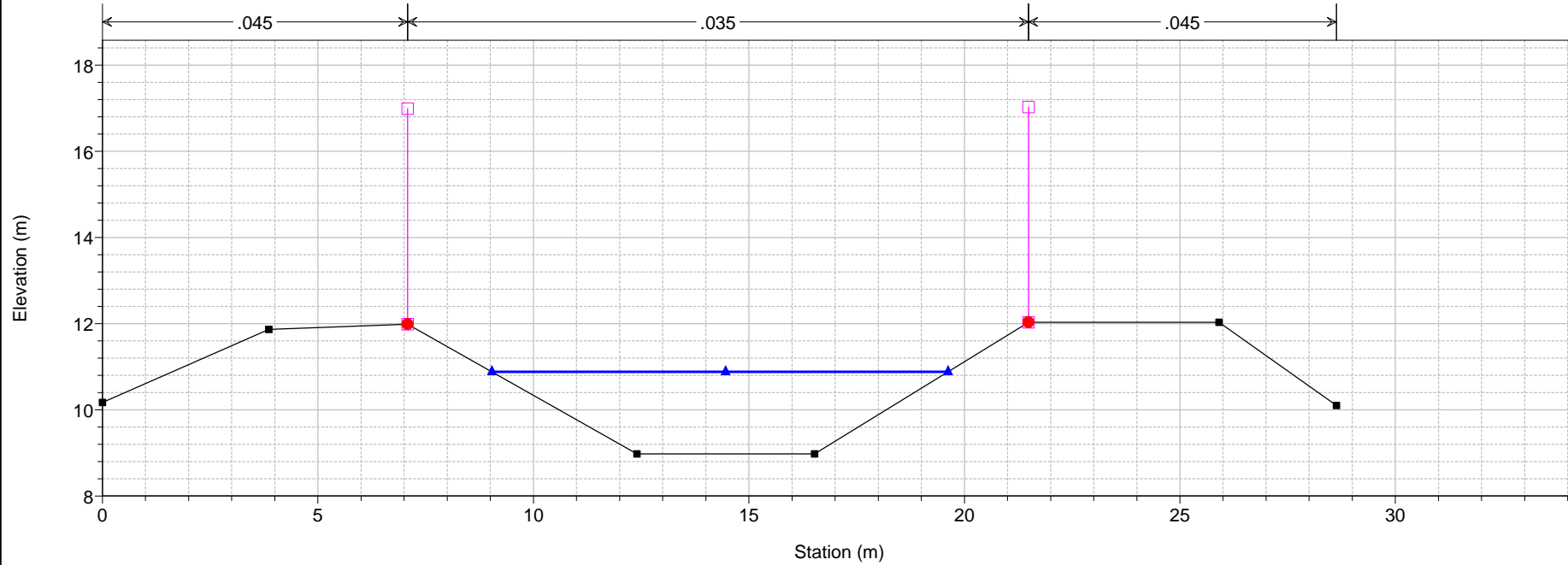

Tripesce Plan: 1) TR200 3H 1/8/19 2) TR303H 1/8/19
Sez. 13 new

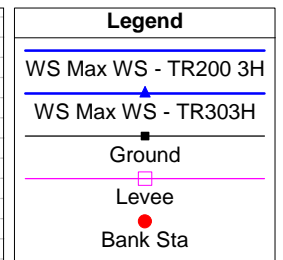
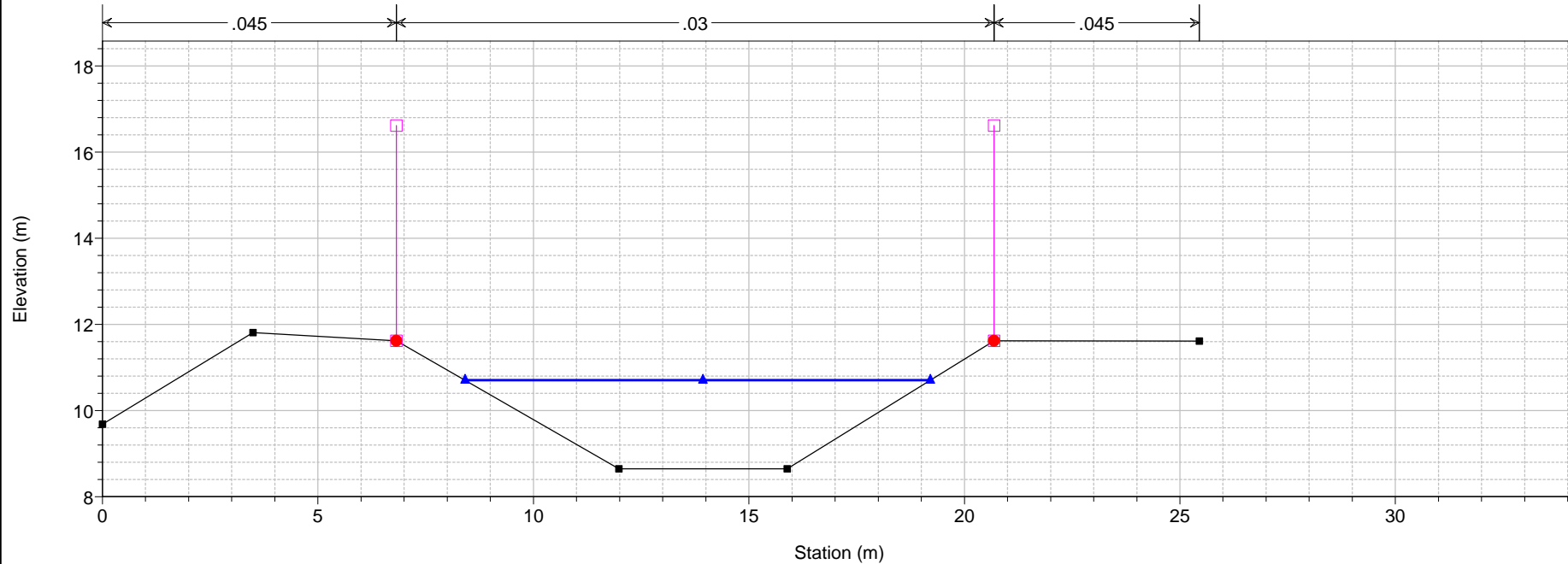

Tripesce Plan: 1) TR200 3H 1/8/19 2) TR303H 1/8/19

Sez. 12 new

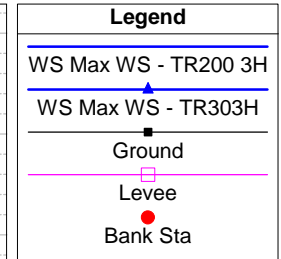
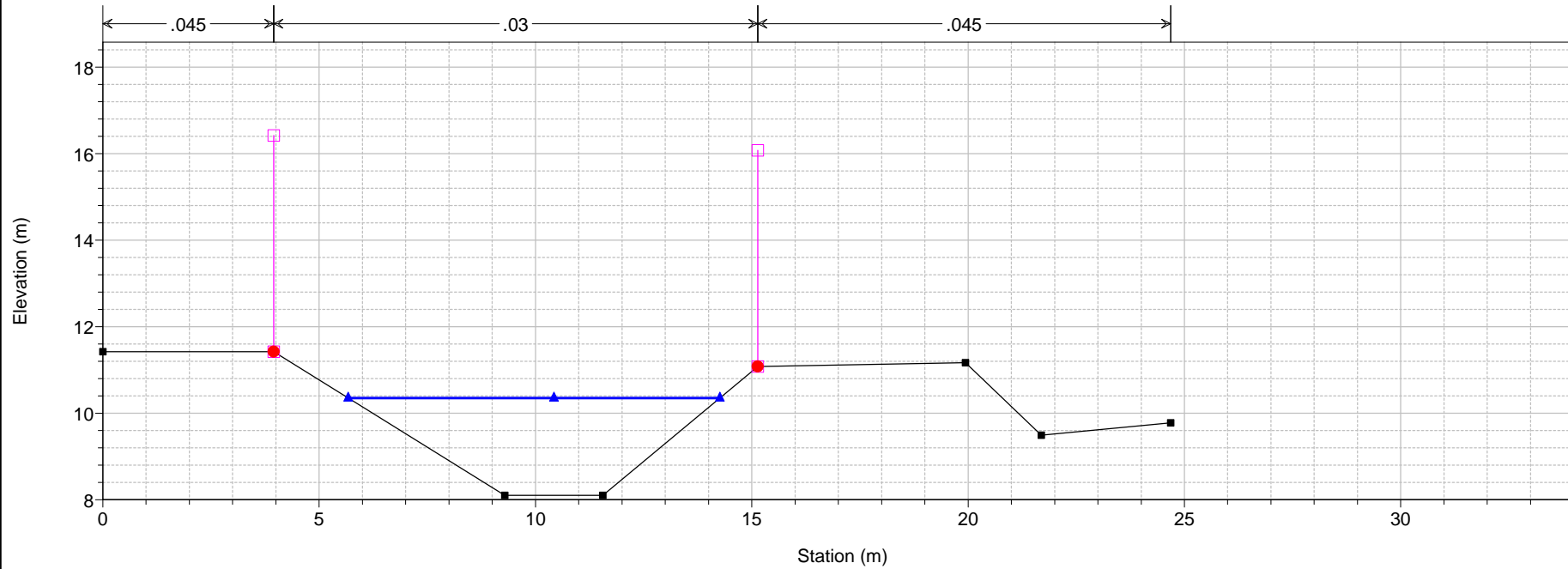

Tripesce Plan: 1) TR200 3H 1/8/19 2) TR303H 1/8/19

Sez. 11 new

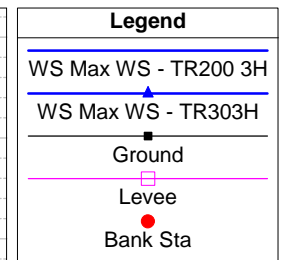
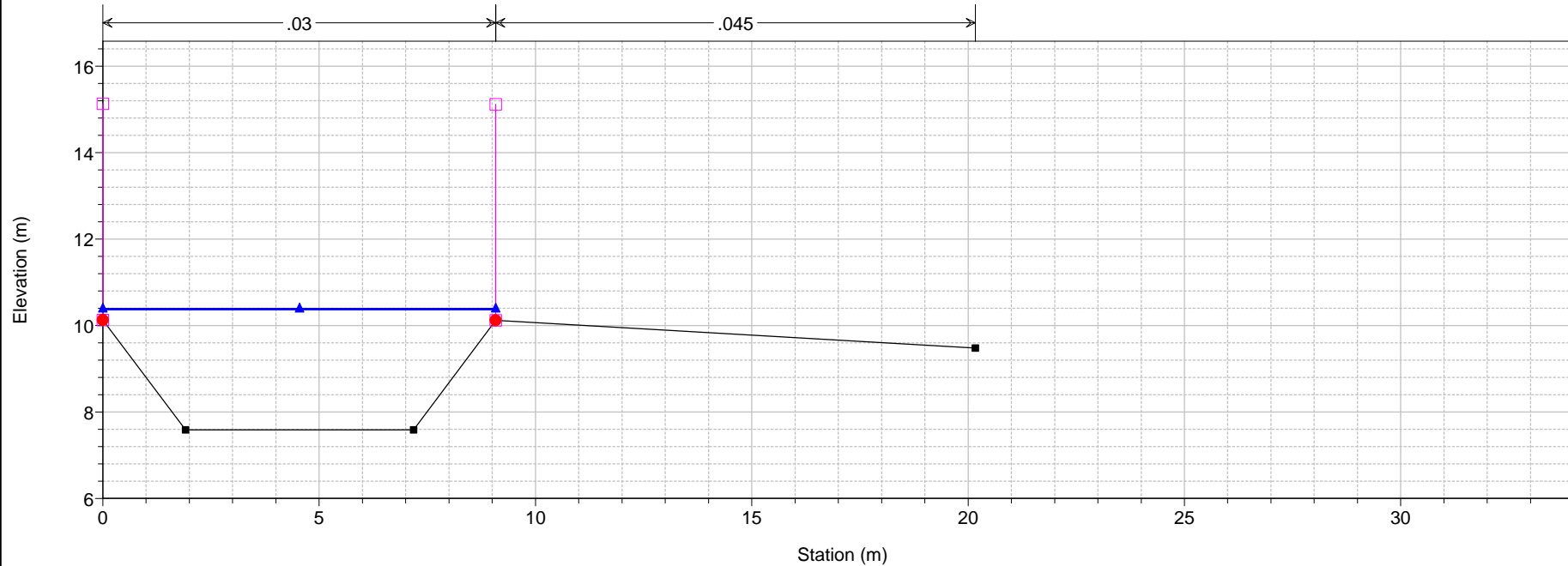

Tripesce Plan: 1) TR200 3H 1/8/19 2) TR303H 1/8/19

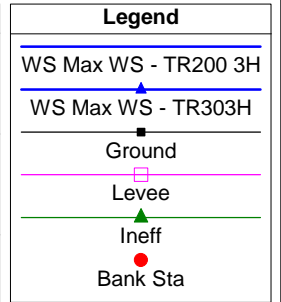
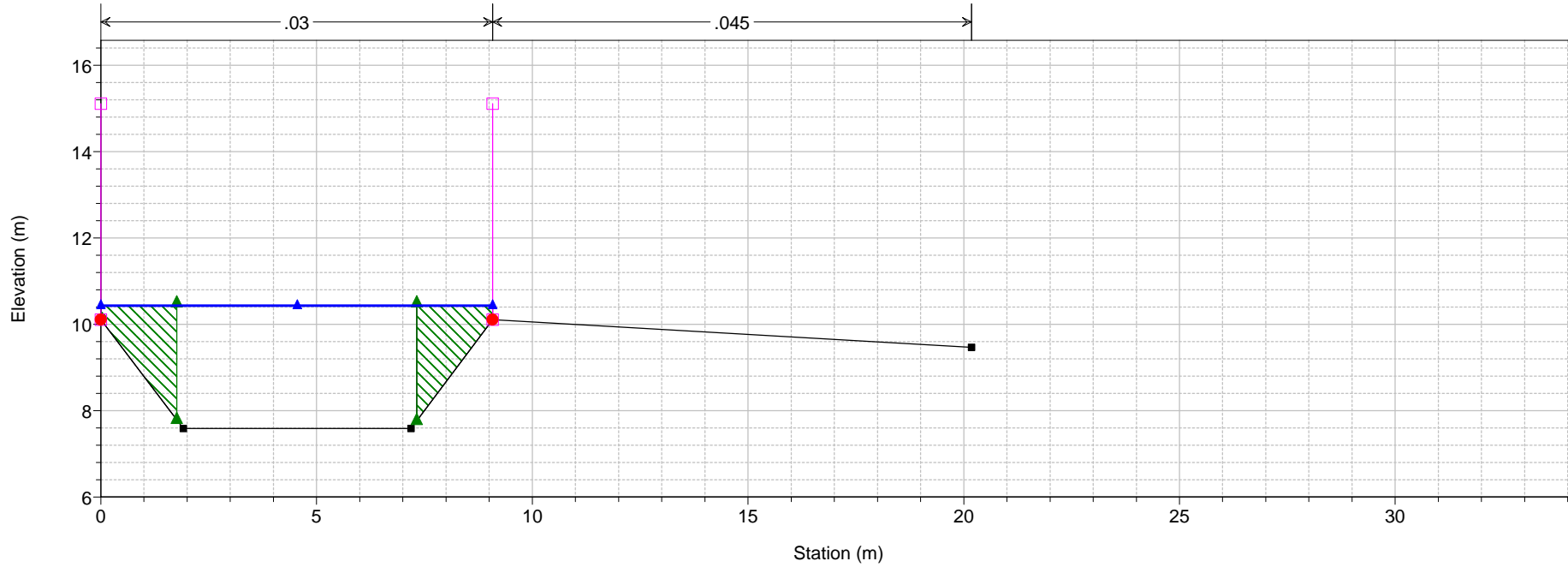

Tripesce Plan: 1) TR200 3H 1/8/19 2) TR303H 1/8/19

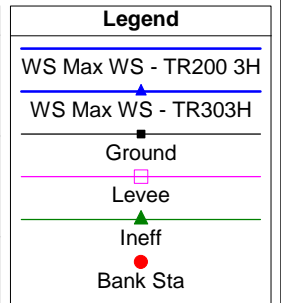
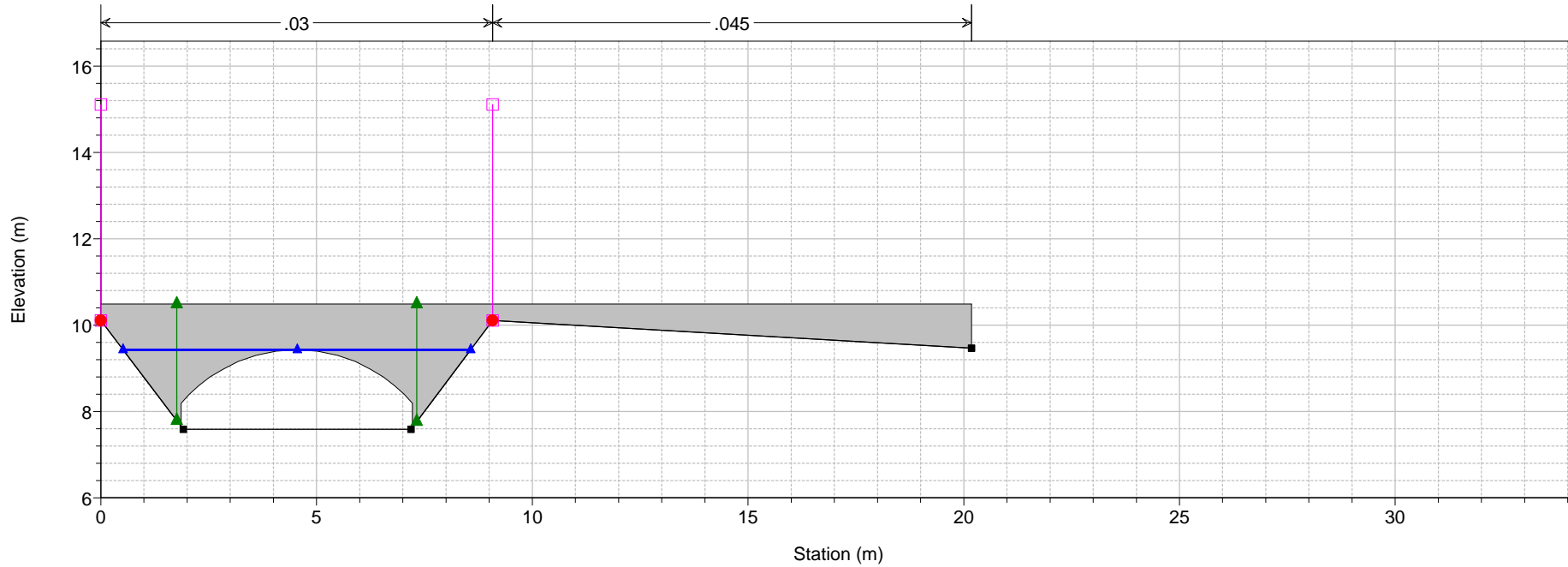

1 cm Horiz. = 1.5 m 1 cm Vert. = 1.5 m

Tripesce Plan: 1) TR200 3H 1/8/19 2) TR303H 1/8/19

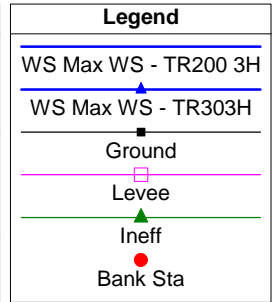
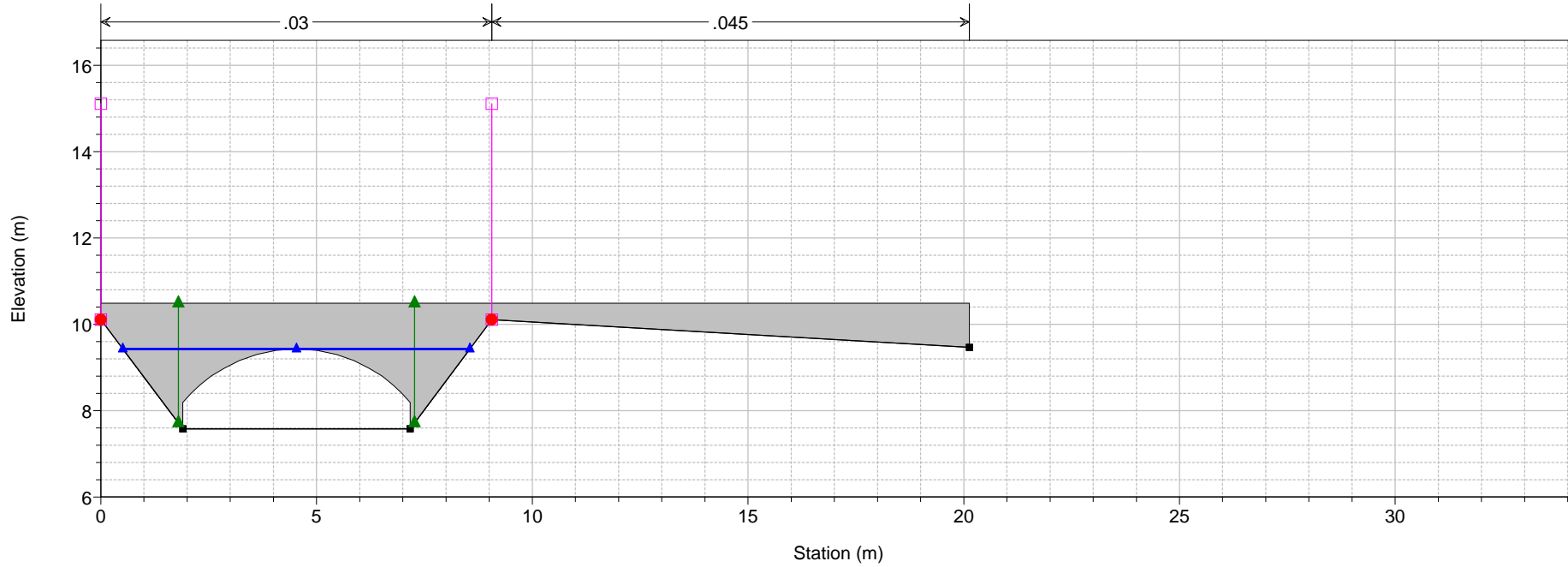

Tripesce Plan: 1) TR200 3H 1/8/19 2) TR303H 1/8/19

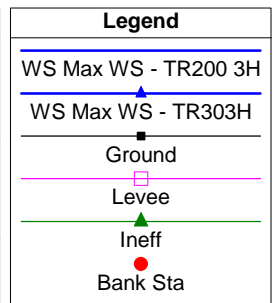
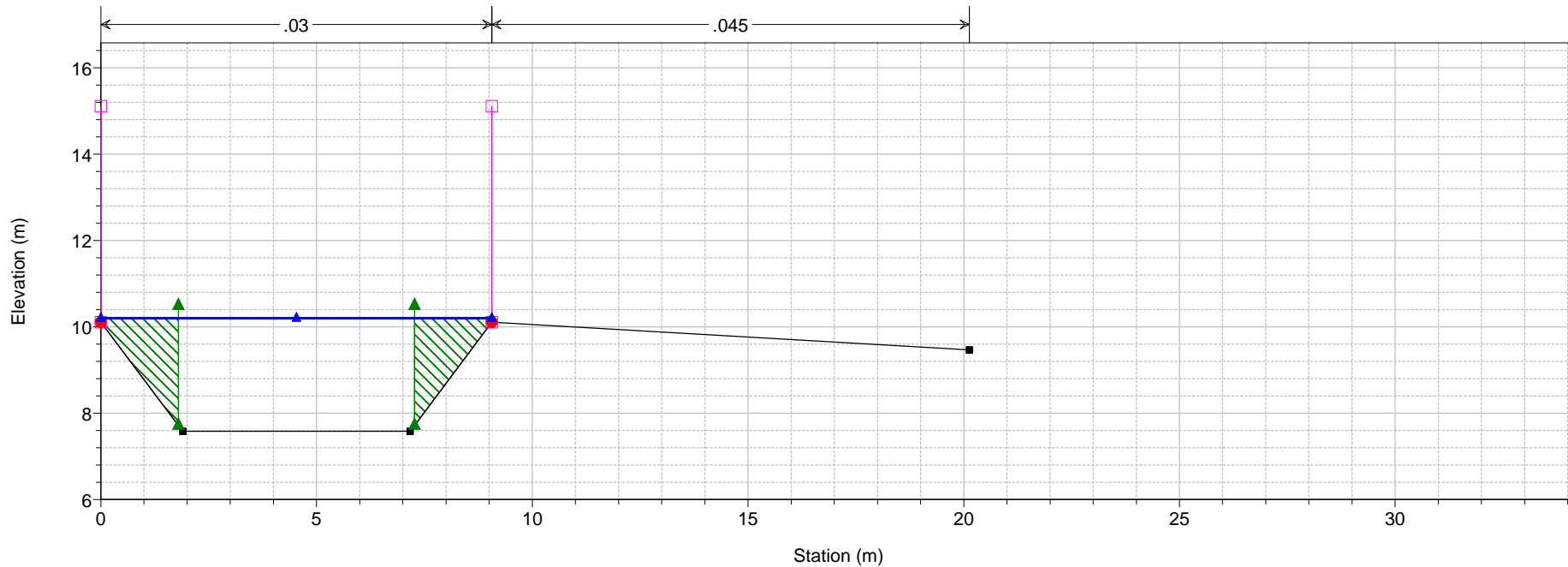

1 cm Horiz. = 1.5 m 1 cm Vert. = 1.5 m

Tripesce Plan: 1) TR200 3H 1/8/19 2) TR303H 1/8/19

Sez. 10.9 new

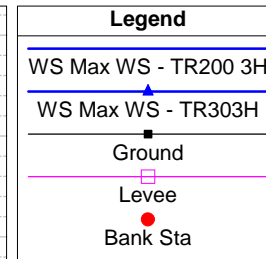
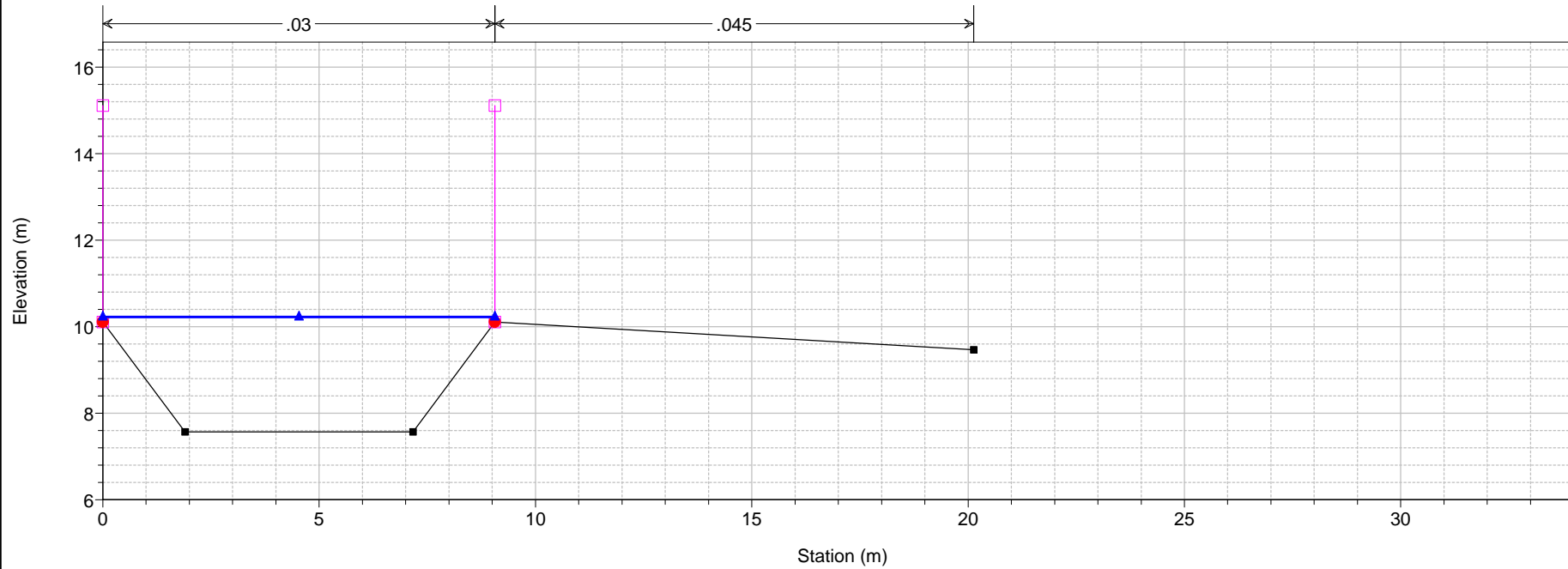

Tripesce Plan: 1) TR200 3H 1/8/19 2) TR303H 1/8/19

Sez. 10.3 new

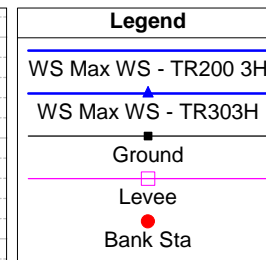
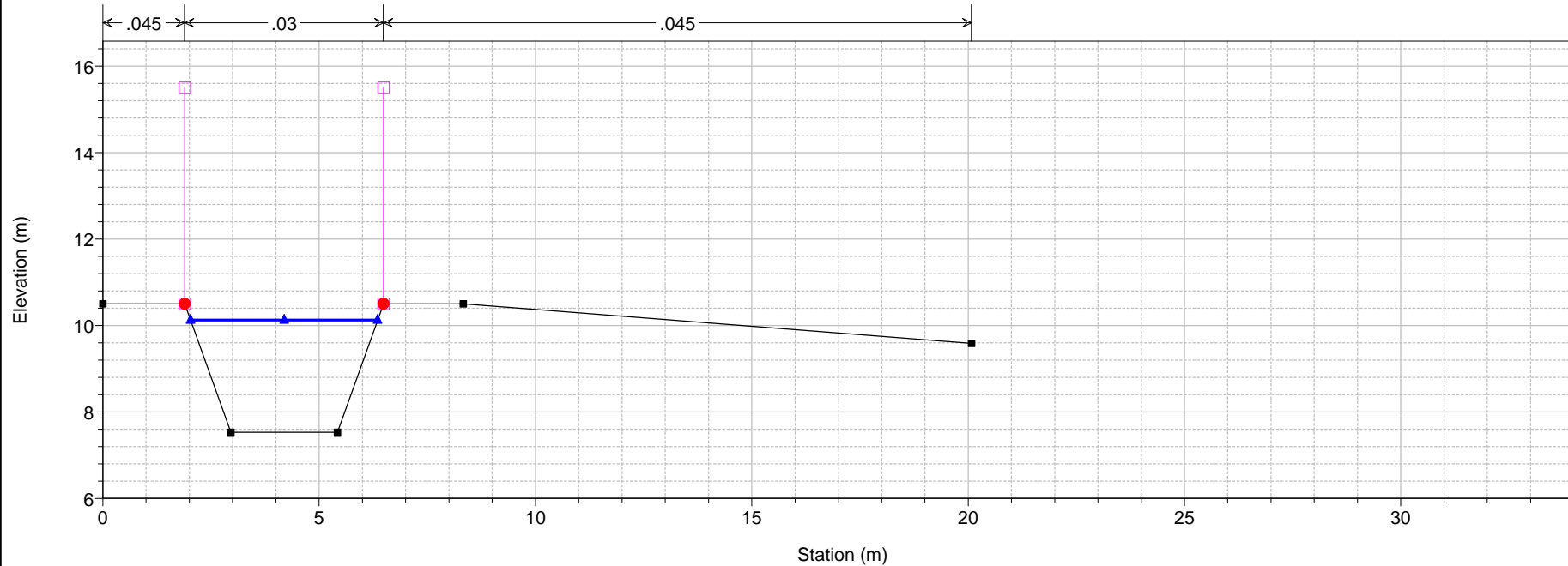

1 cm Horiz. = 1.5 m 1 cm Vert. = 1.5 m

Tripesce Plan: 1) TR200 3H 1/8/19 2) TR303H 1/8/19

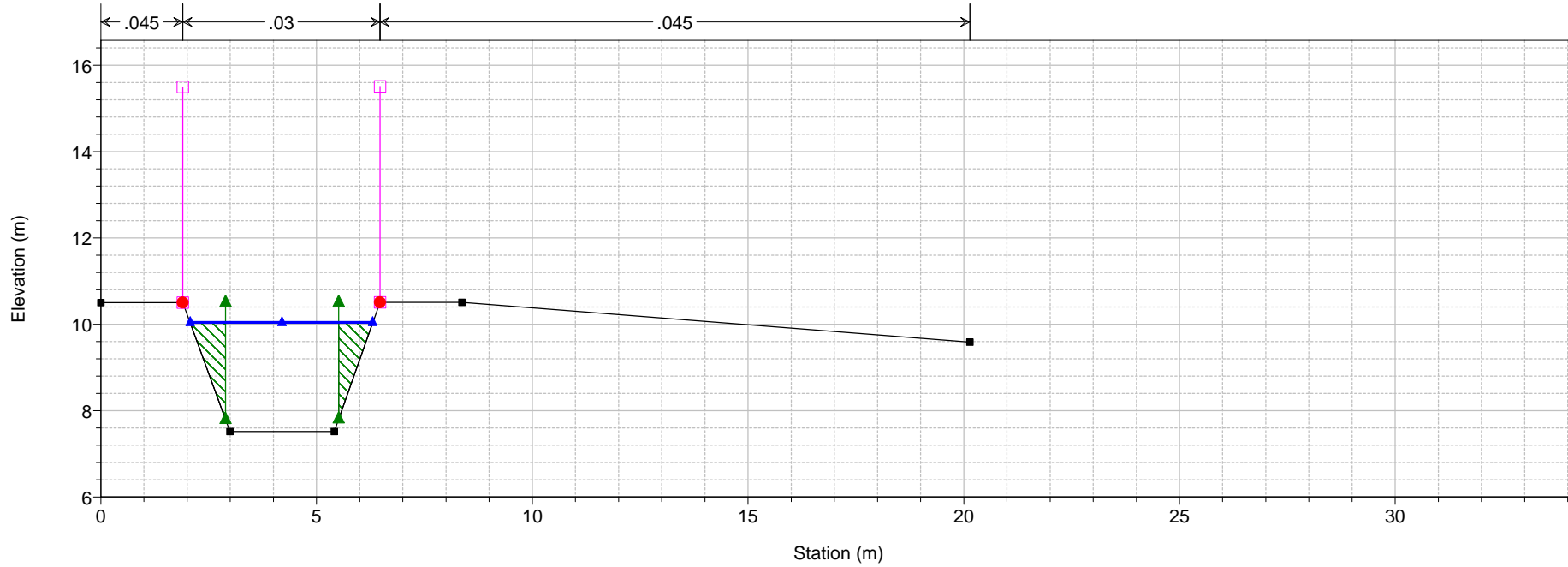

Tripesce Plan: 1) TR200 3H 1/8/19 2) TR303H 1/8/19

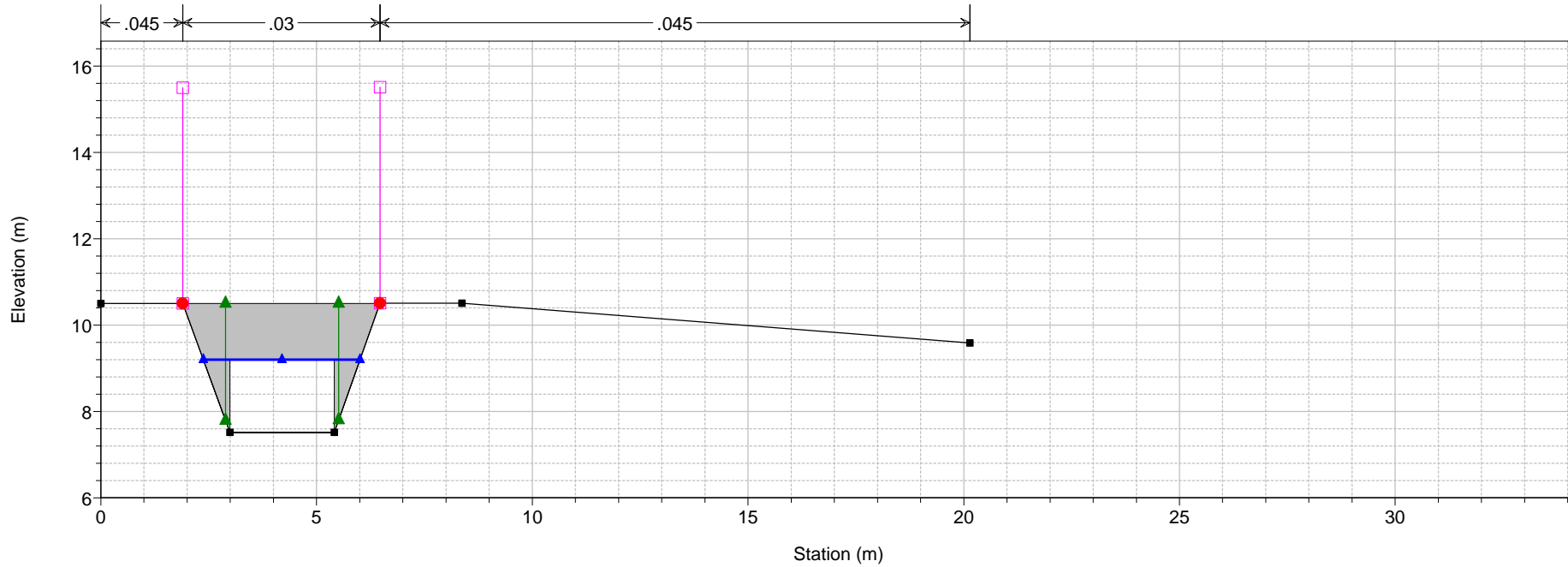

1 cm Horiz. = 1.5 m 1 cm Vert. = 1.5 m

Tripesce Plan: 1) TR200 3H 1/8/19 2) TR303H 1/8/19

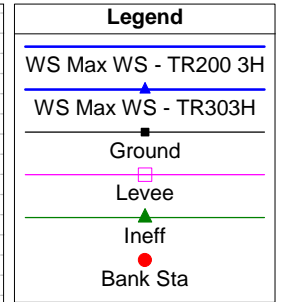
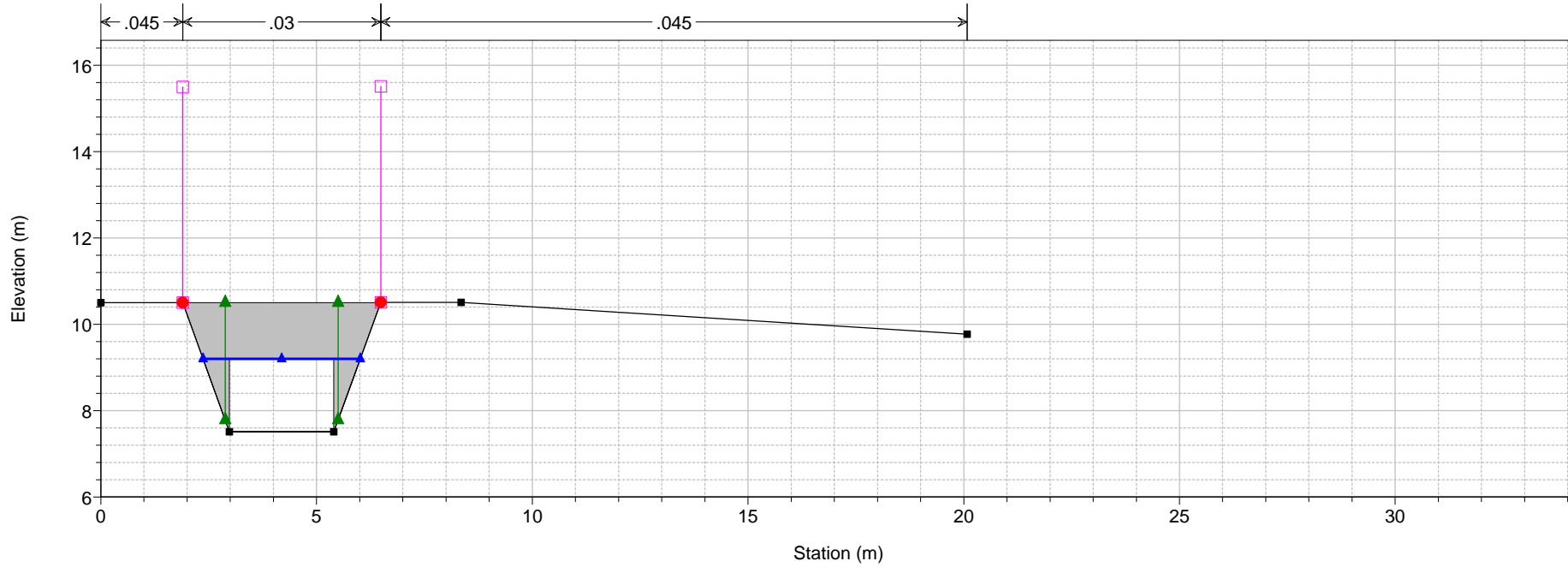

Tripesce Plan: 1) TR200 3H 1/8/19 2) TR303H 1/8/19

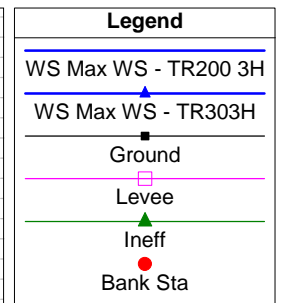
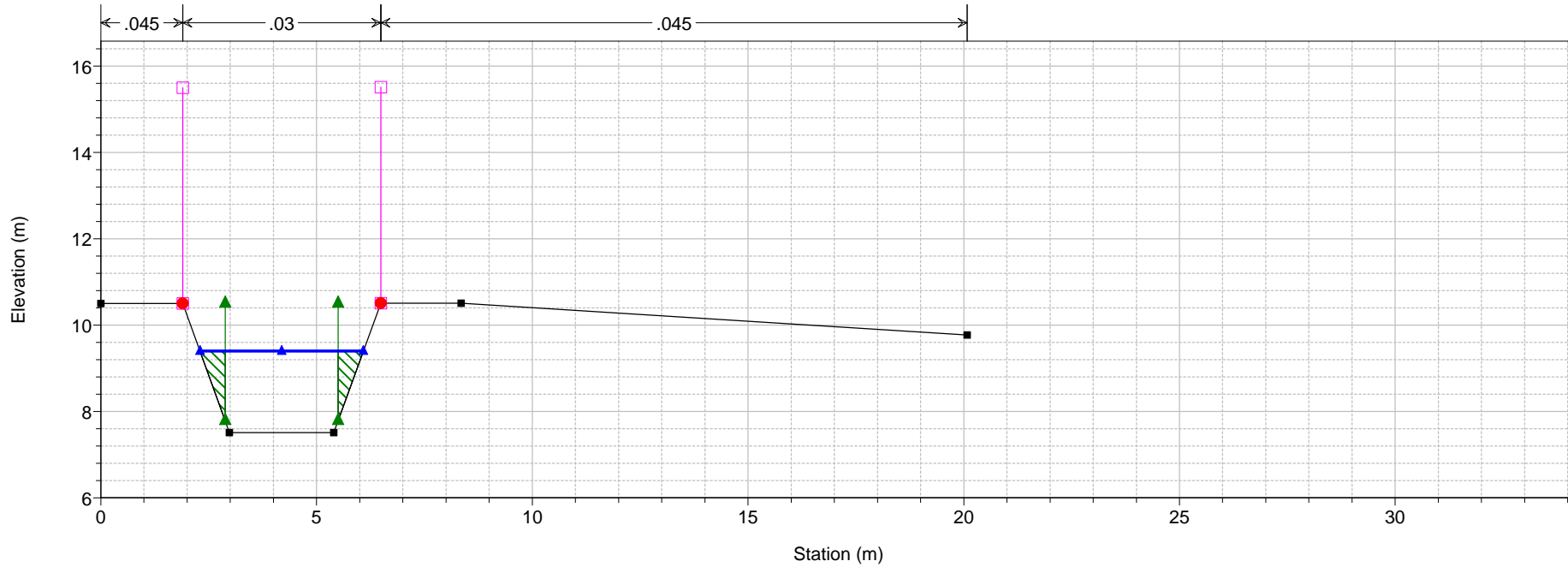

1 cm Horiz. = 1.5 m 1 cm Vert. = 1.5 m

Tripesce Plan: 1) TR200 3H 1/8/19 2) TR303H 1/8/19

Sez. 10 new

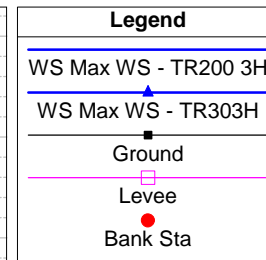
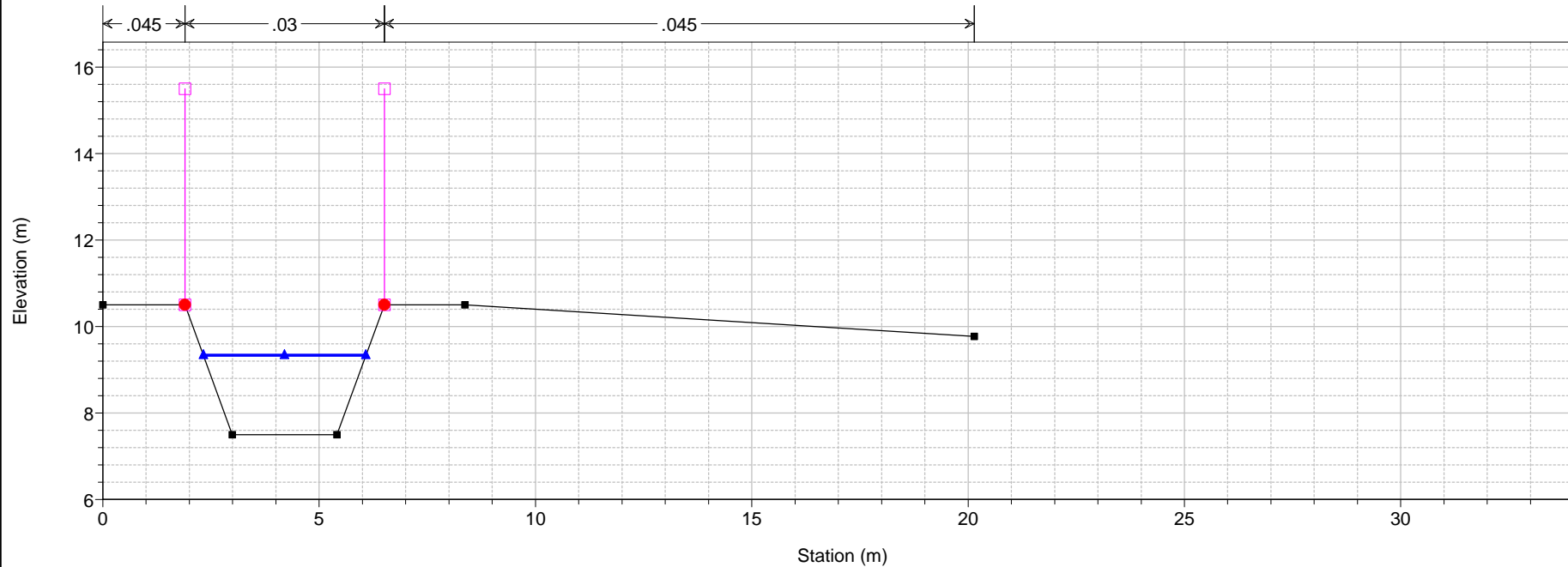

Tripesce Plan: 1) TR200 3H 1/8/19 2) TR303H 1/8/19

Sez. 9 new

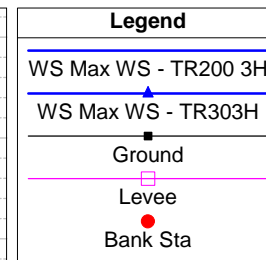
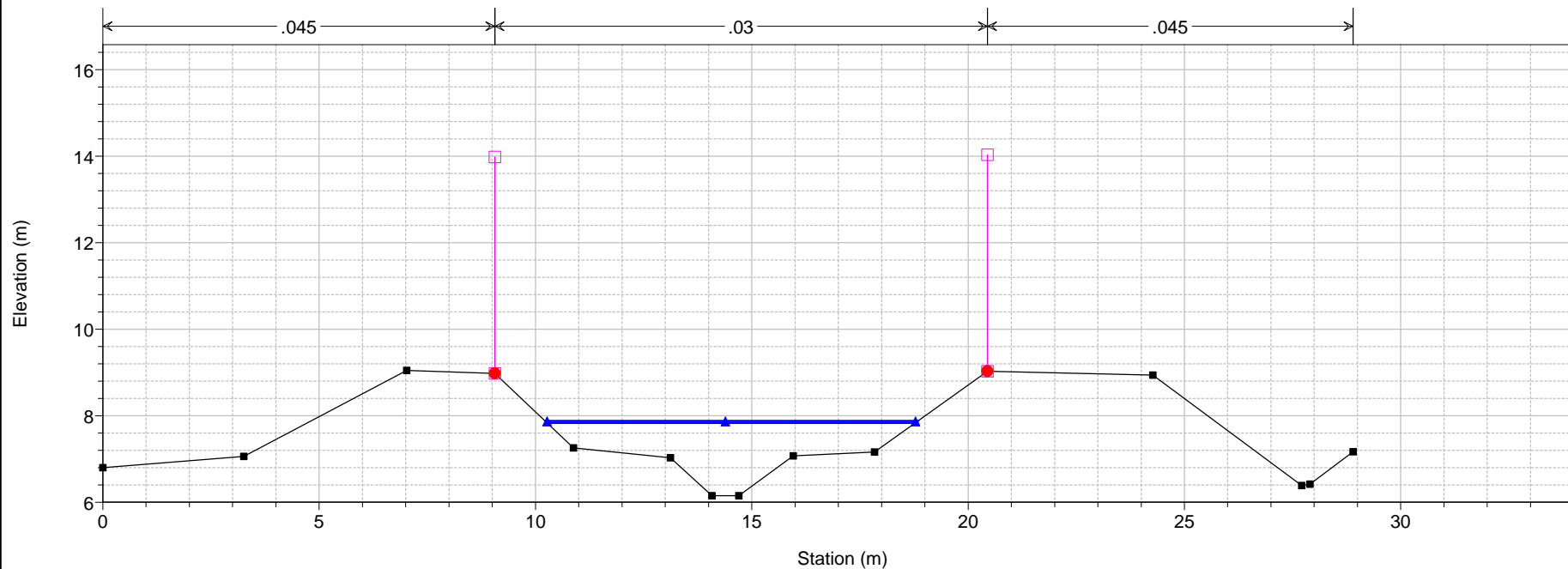

Tripesce Plan: 1) TR200 3H 1/8/19 2) TR303H 1/8/19

Sez. 8.3 new

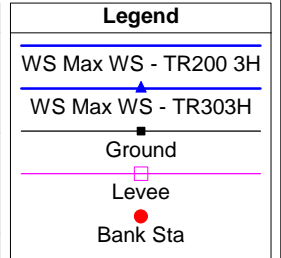
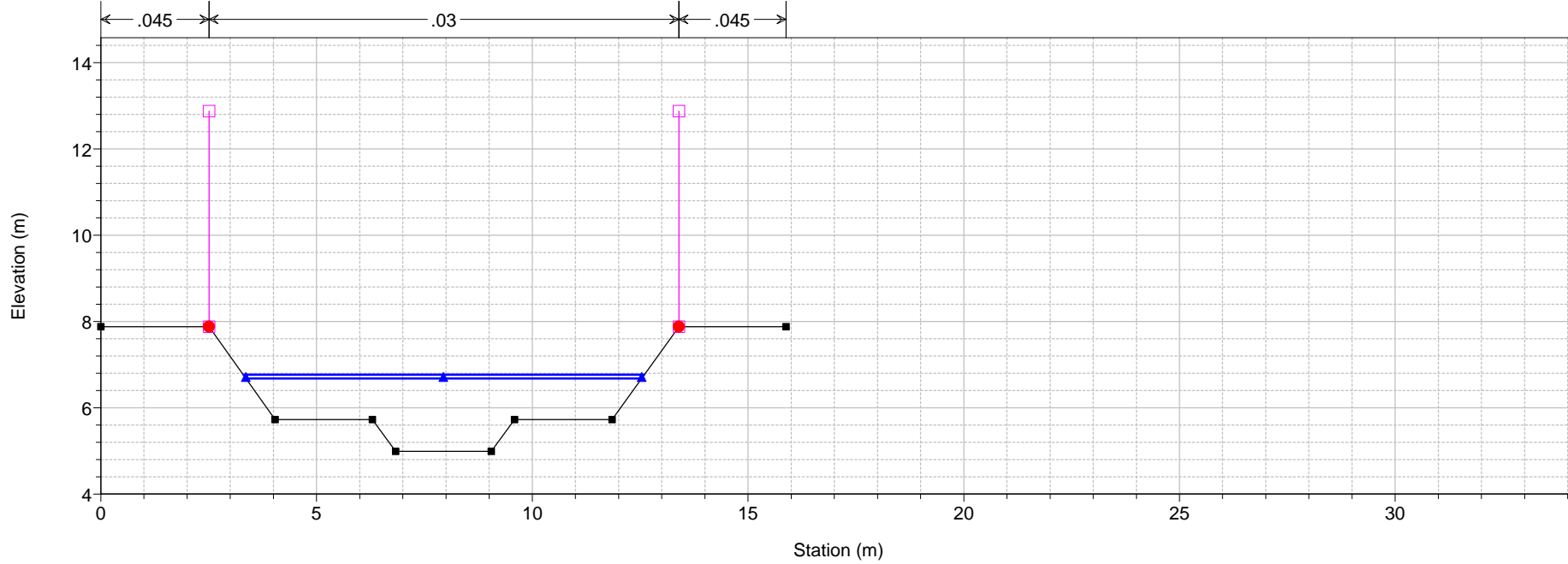

Tripesce Plan: 1) TR200 3H 1/8/19 2) TR303H 1/8/19

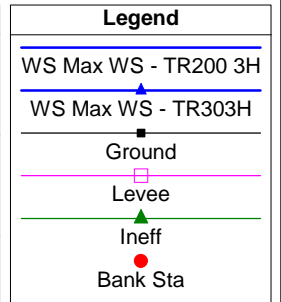
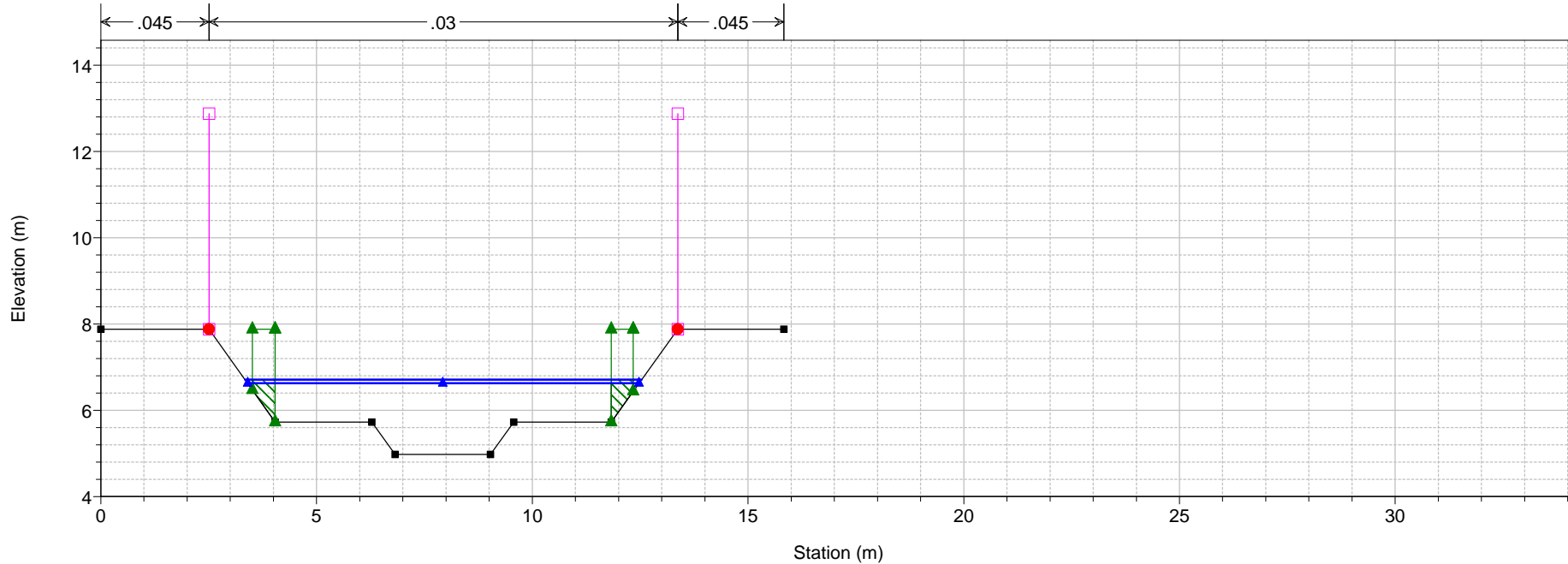

1 cm Horiz. = 1.5 m 1 cm Vert. = 1.5 m

Tripesce Plan: 1) TR200 3H 1/8/19 2) TR303H 1/8/19

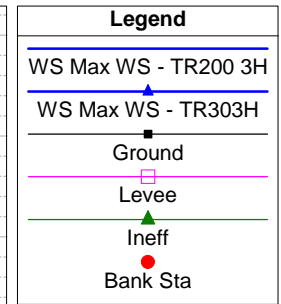
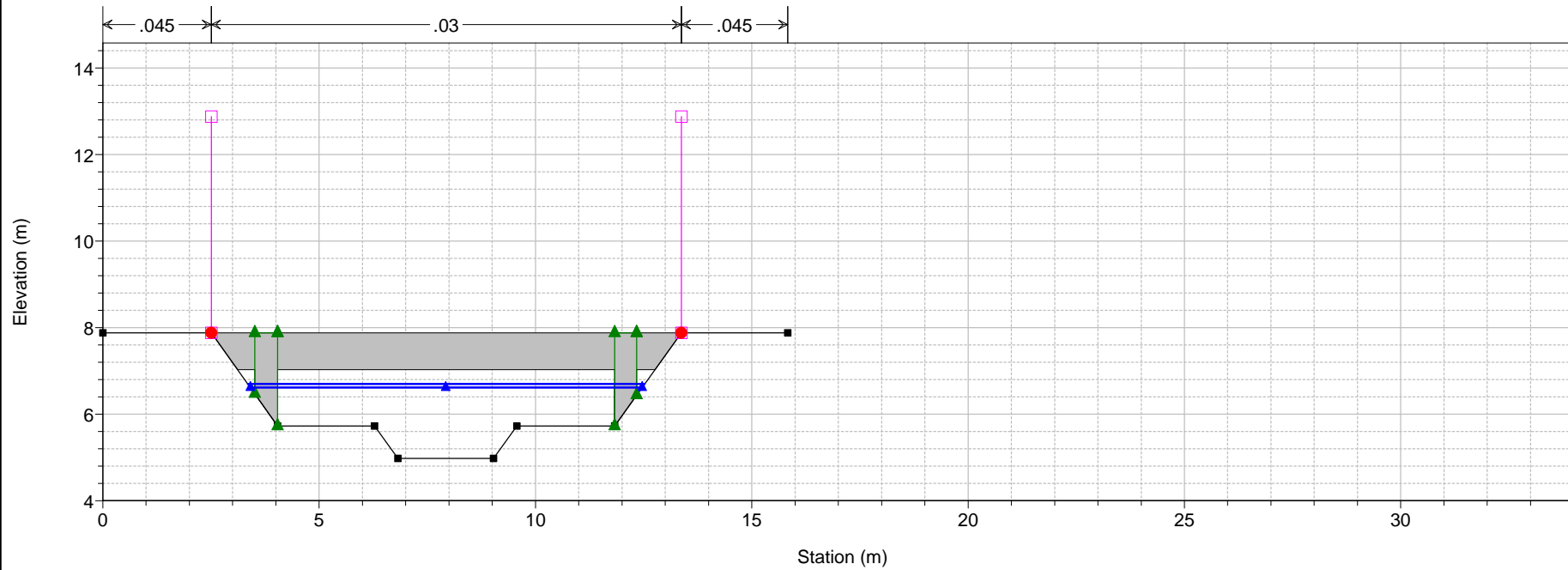

Tripesce Plan: 1) TR200 3H 1/8/19 2) TR303H 1/8/19

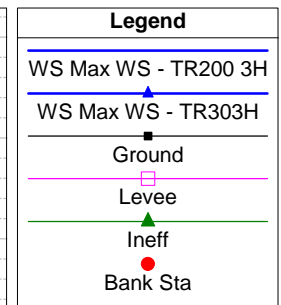
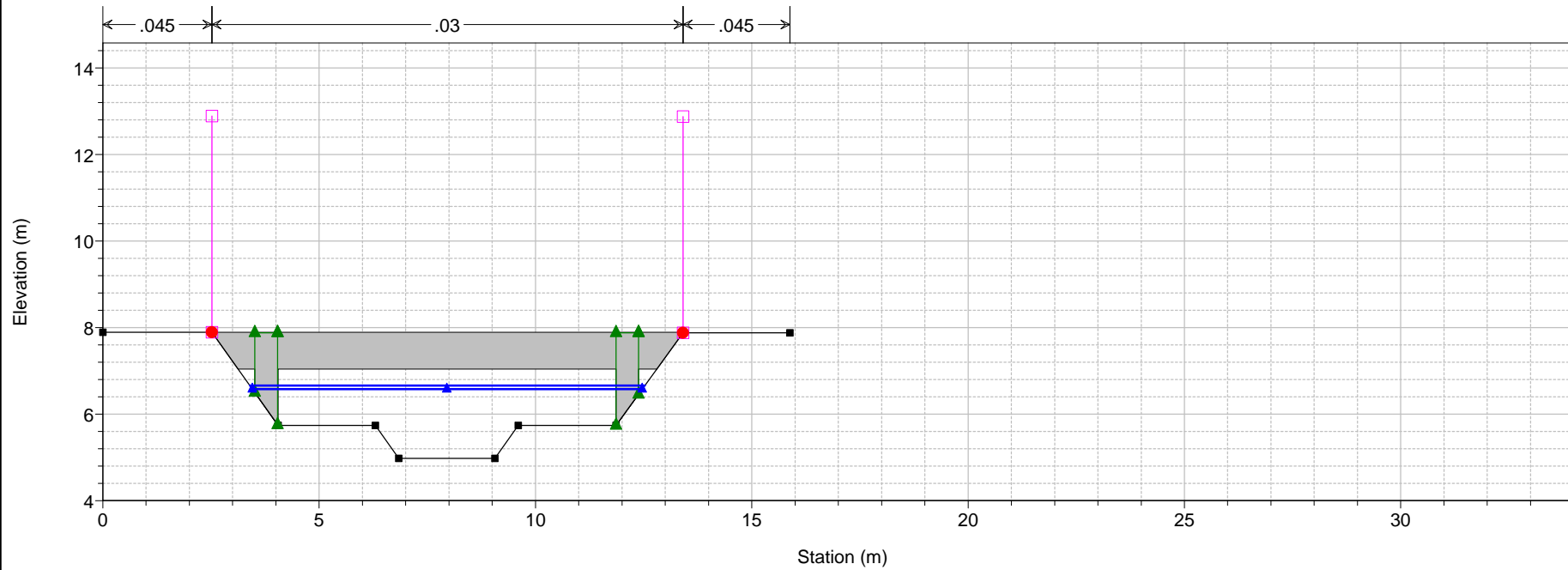

1 cm Horiz. = 1.5 m 1 cm Vert. = 1.5 m

Tripesce Plan: 1) TR200 3H 1/8/19 2) TR303H 1/8/19

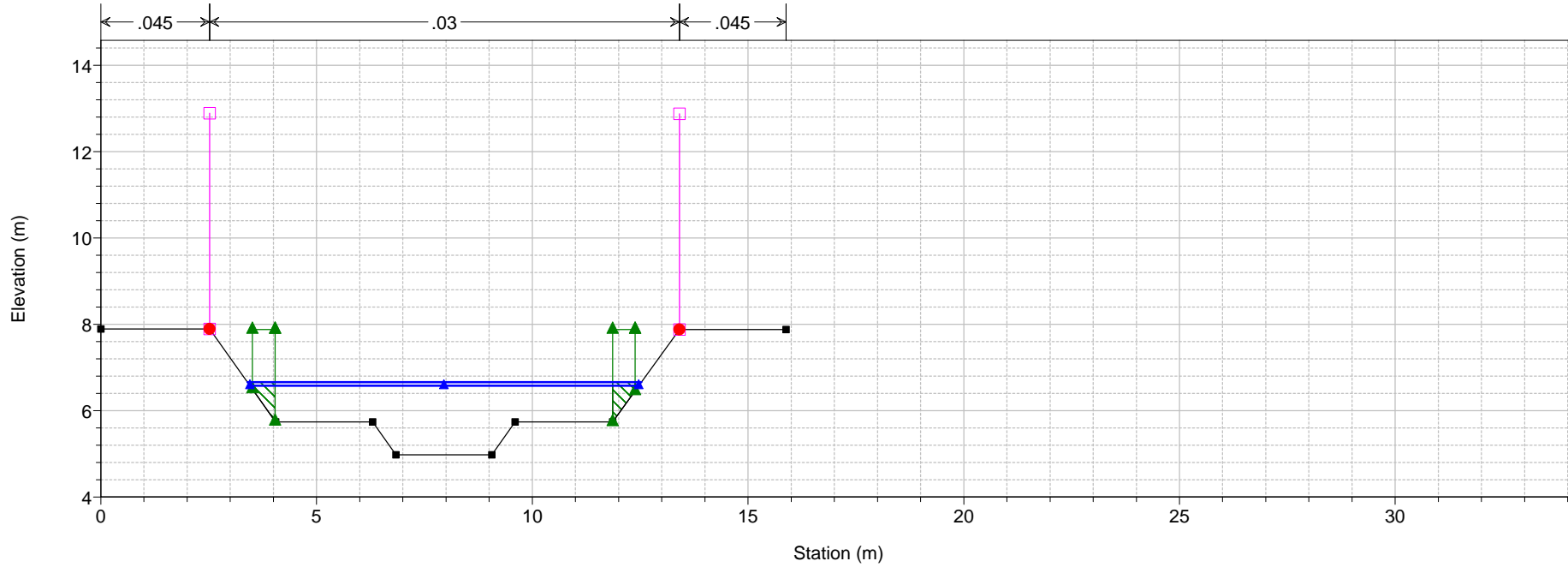

Tripesce Plan: 1) TR200 3H 1/8/19 2) TR303H 1/8/19
Sez. 8 new

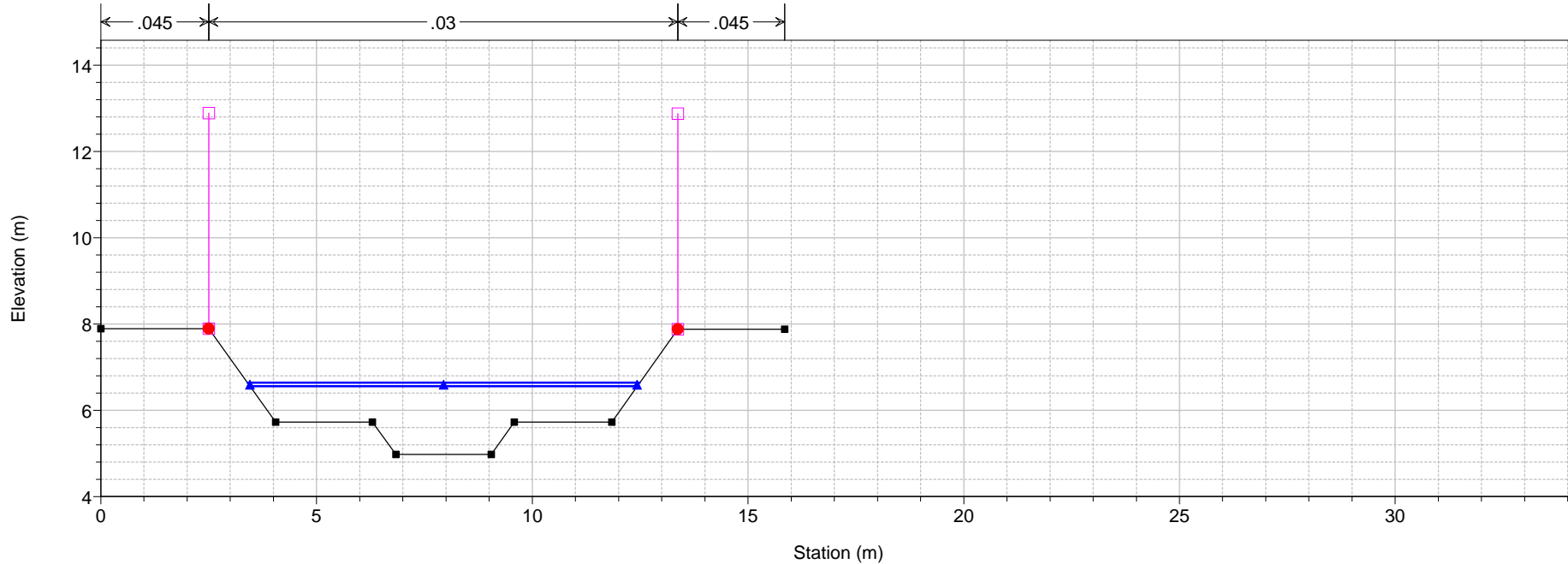

1 cm Horiz. = 1.5 m 1 cm Vert. = 1.5 m

Tripesce Plan: 1) TR200 3H 1/8/19 2) TR303H 1/8/19

Sez. 7 new

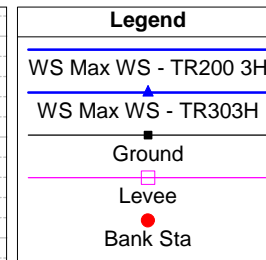
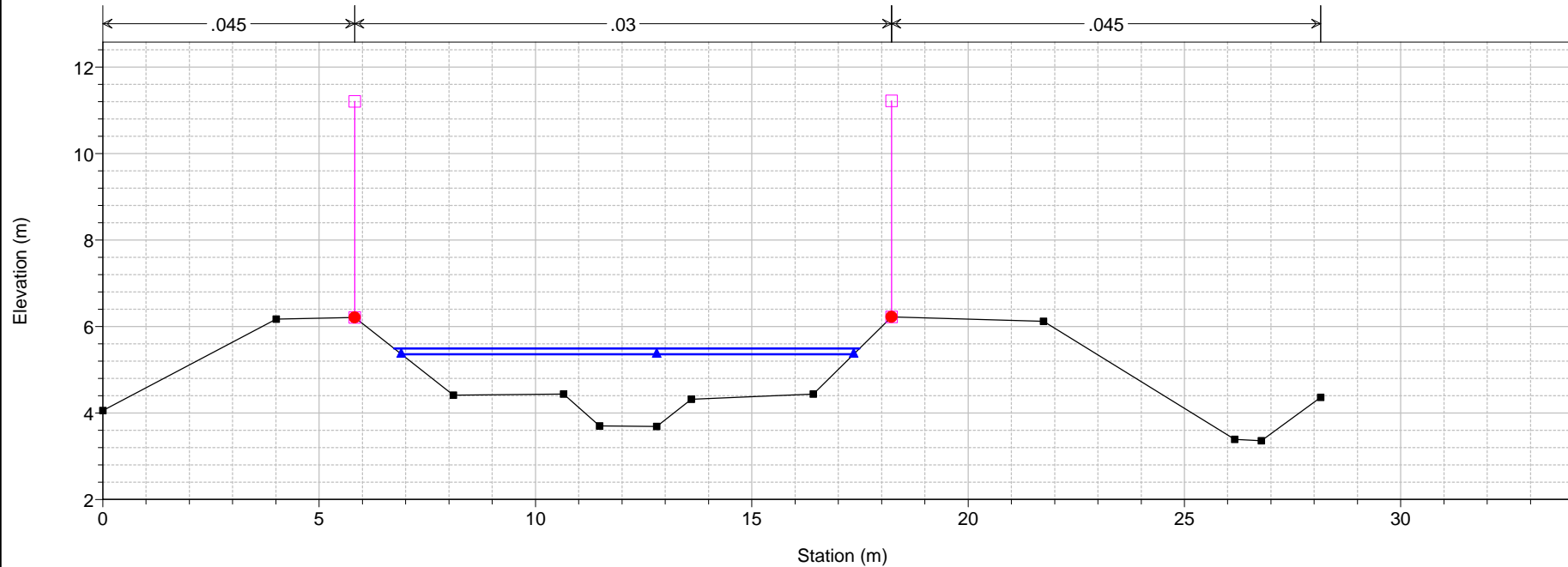

Tripesce Plan: 1) TR200 3H 1/8/19 2) TR303H 1/8/19

Sez. 6.3 new

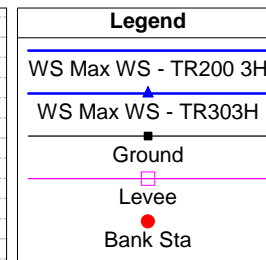
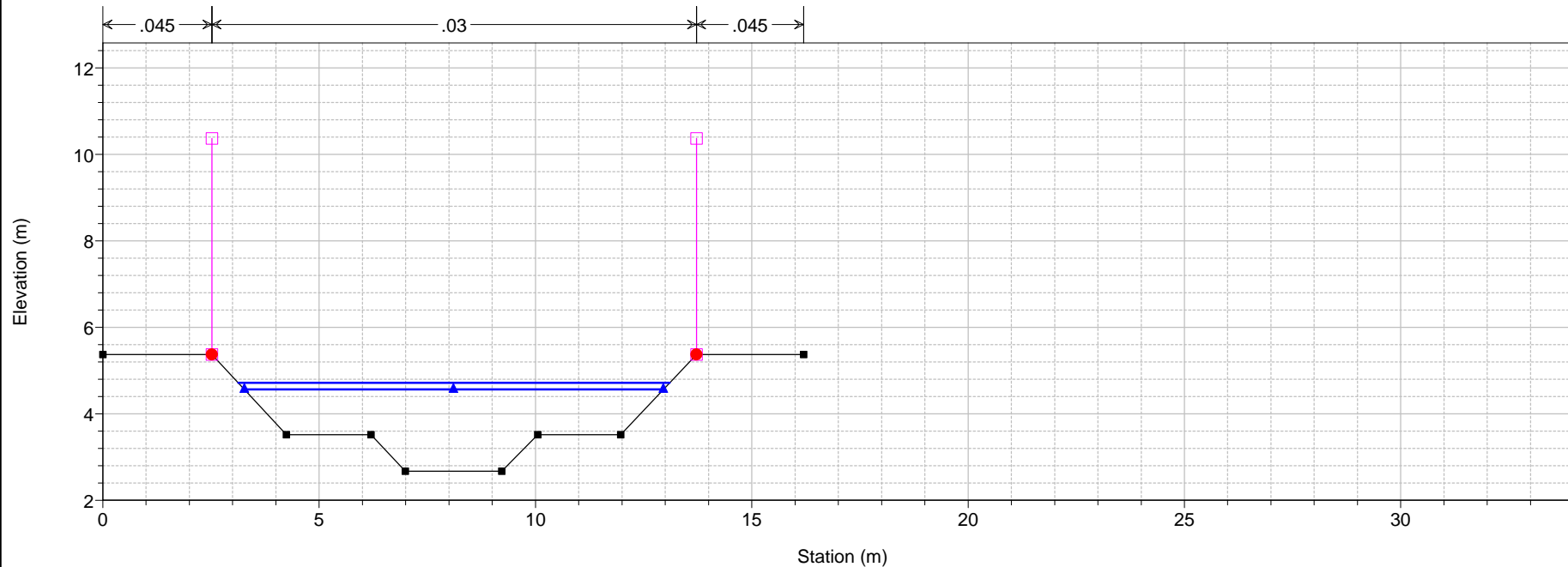

1 cm Horiz. = 1.5 m 1 cm Vert. = 1.5 m

Tripesce Plan: 1) TR200 3H 1/8/19 2) TR303H 1/8/19

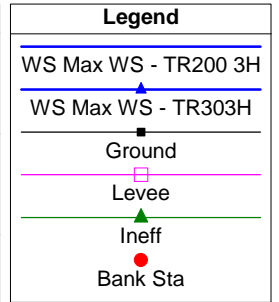
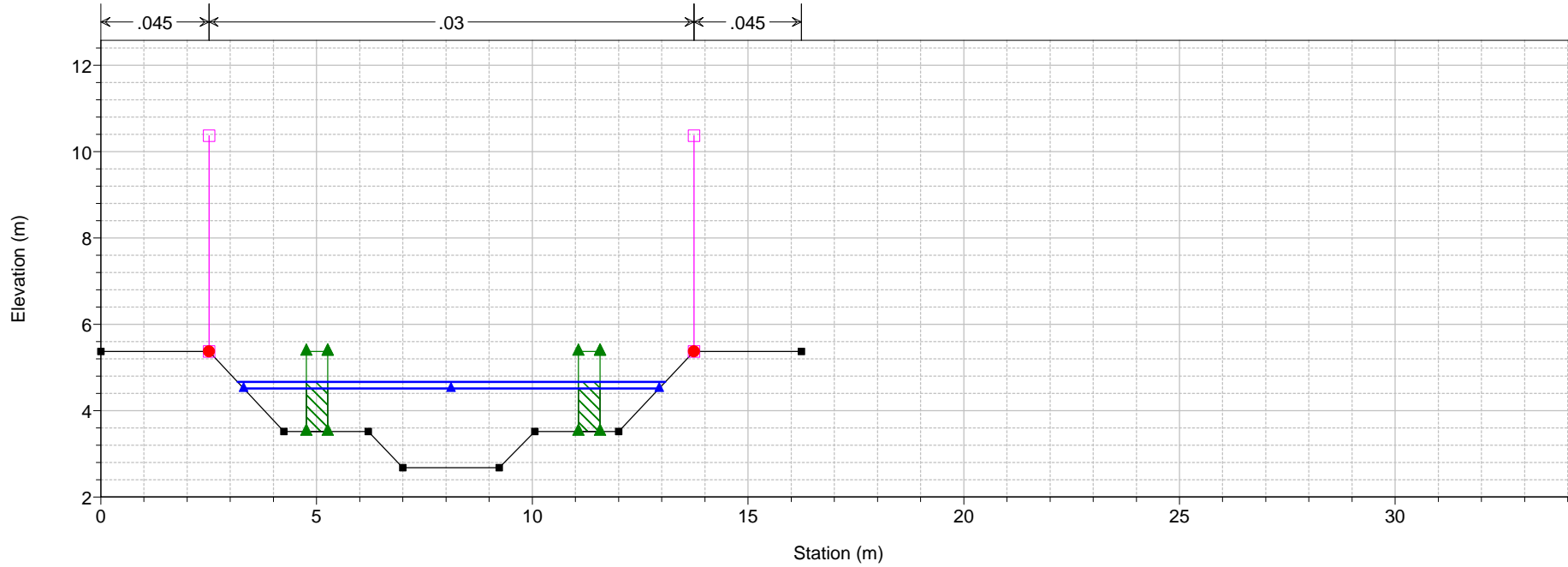

Tripesce Plan: 1) TR200 3H 1/8/19 2) TR303H 1/8/19

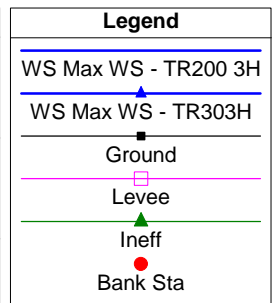
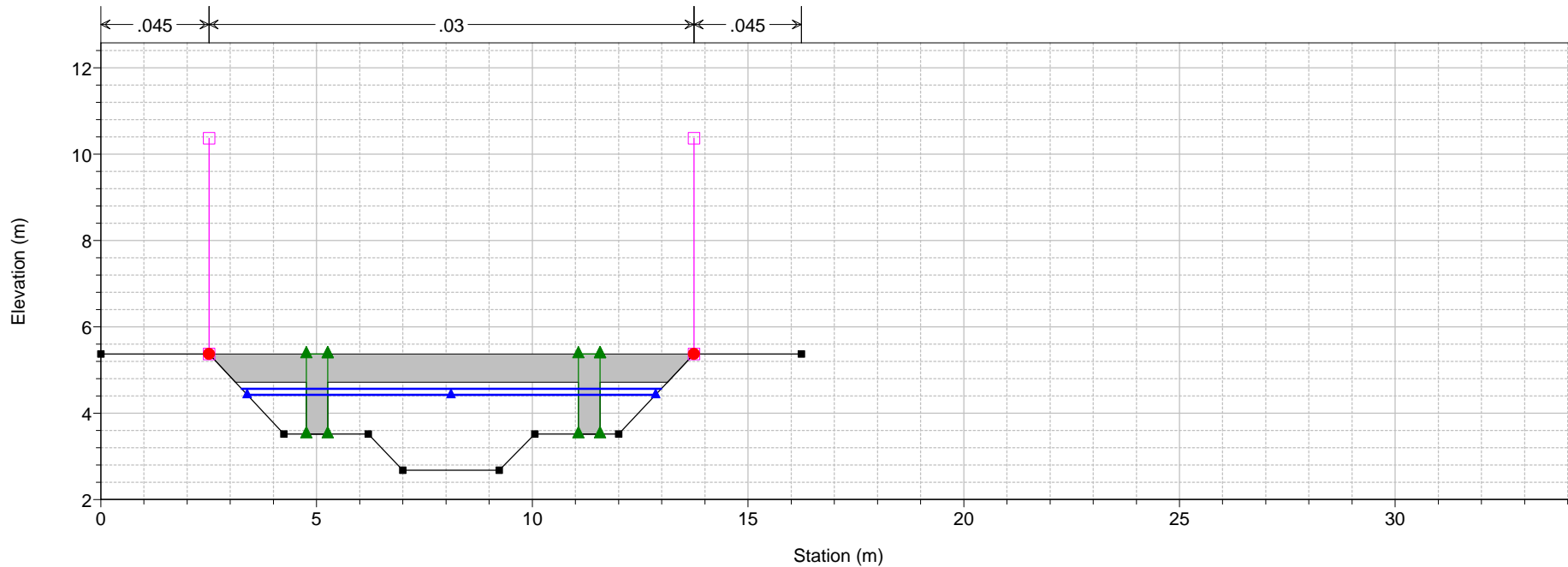

1 cm Horiz. = 1.5 m 1 cm Vert. = 1.5 m

Tripesce Plan: 1) TR200 3H 1/8/19 2) TR303H 1/8/19

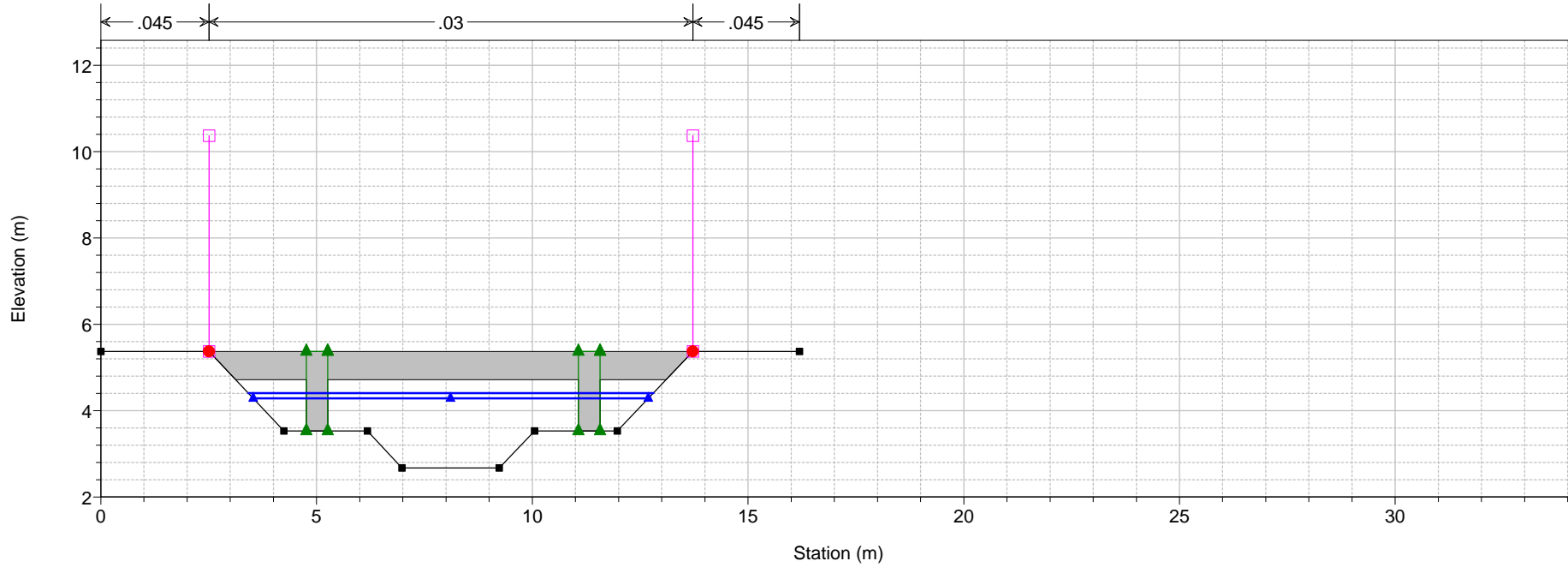

Tripesce Plan: 1) TR200 3H 1/8/19 2) TR303H 1/8/19

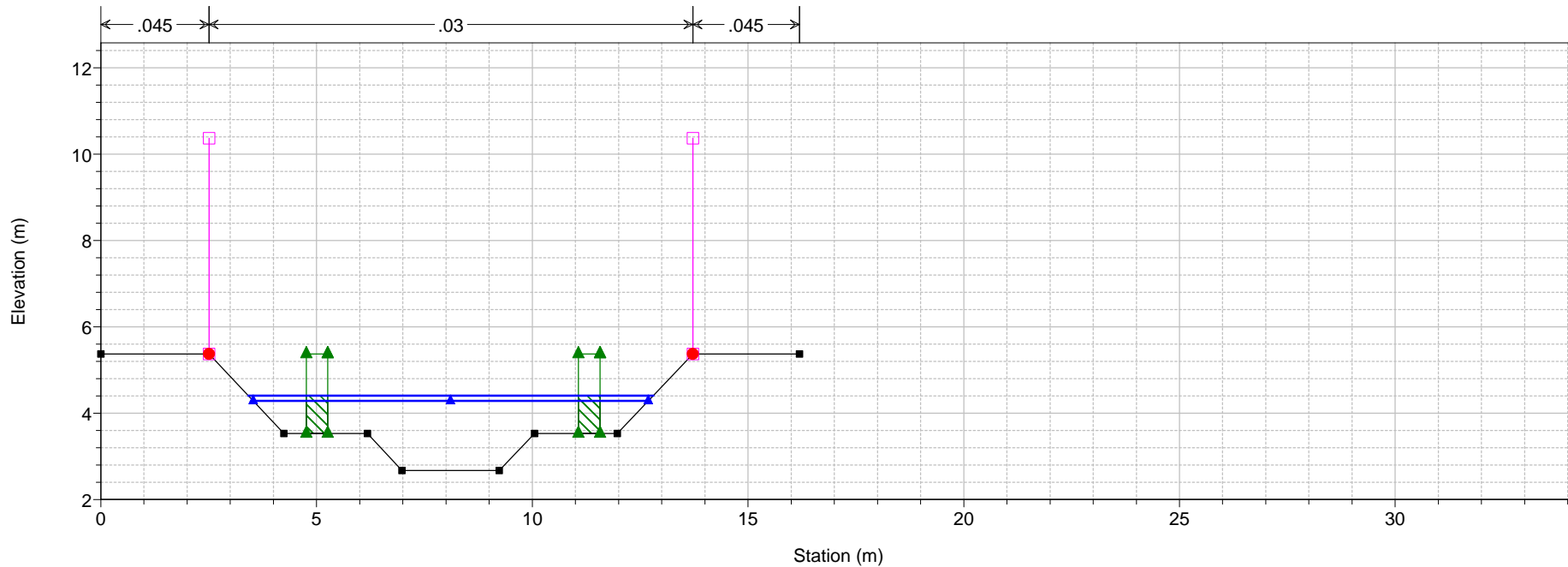

1 cm Horiz. = 1.5 m 1 cm Vert. = 1.5 m

Tripesce Plan: 1) TR200 3H 1/8/19 2) TR303H 1/8/19
Sez. 6 new

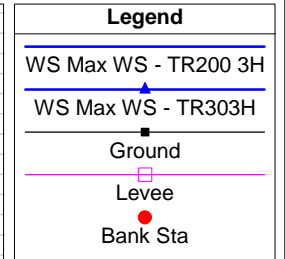
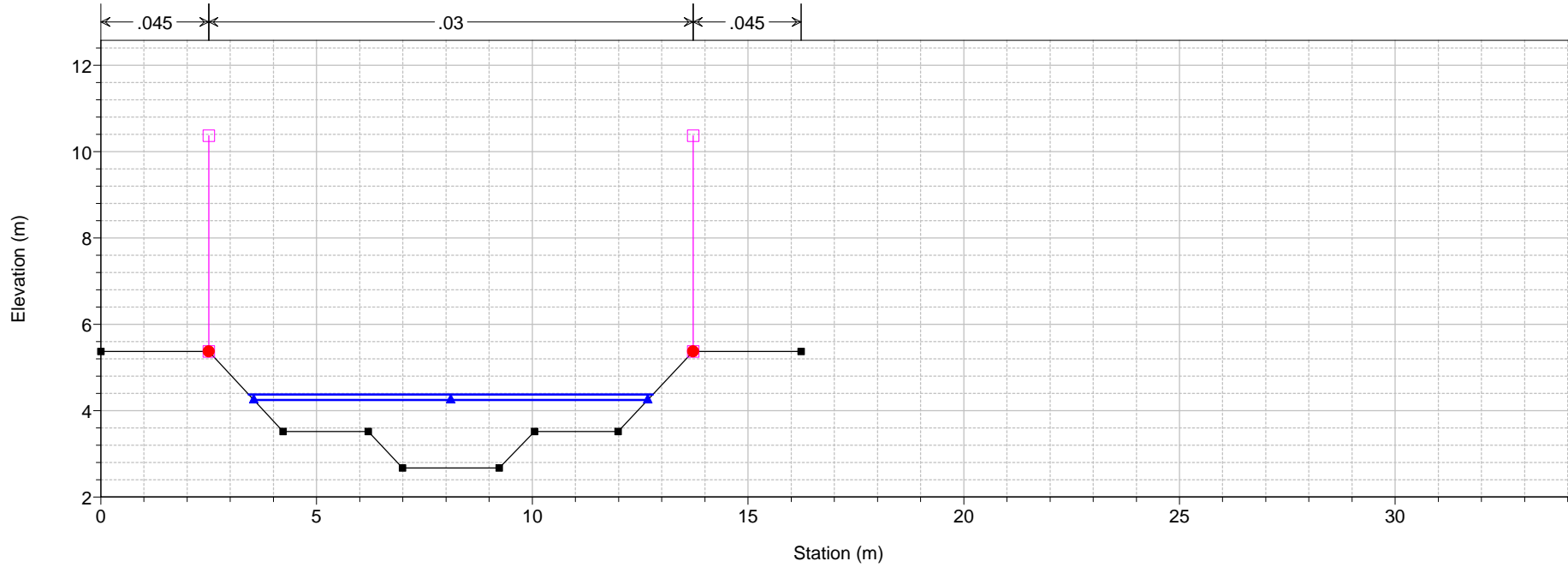

Tripesce Plan: 1) TR200 3H 1/8/19 2) TR303H 1/8/19
Sez. 5 new

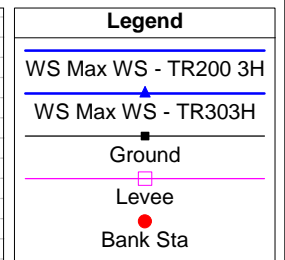
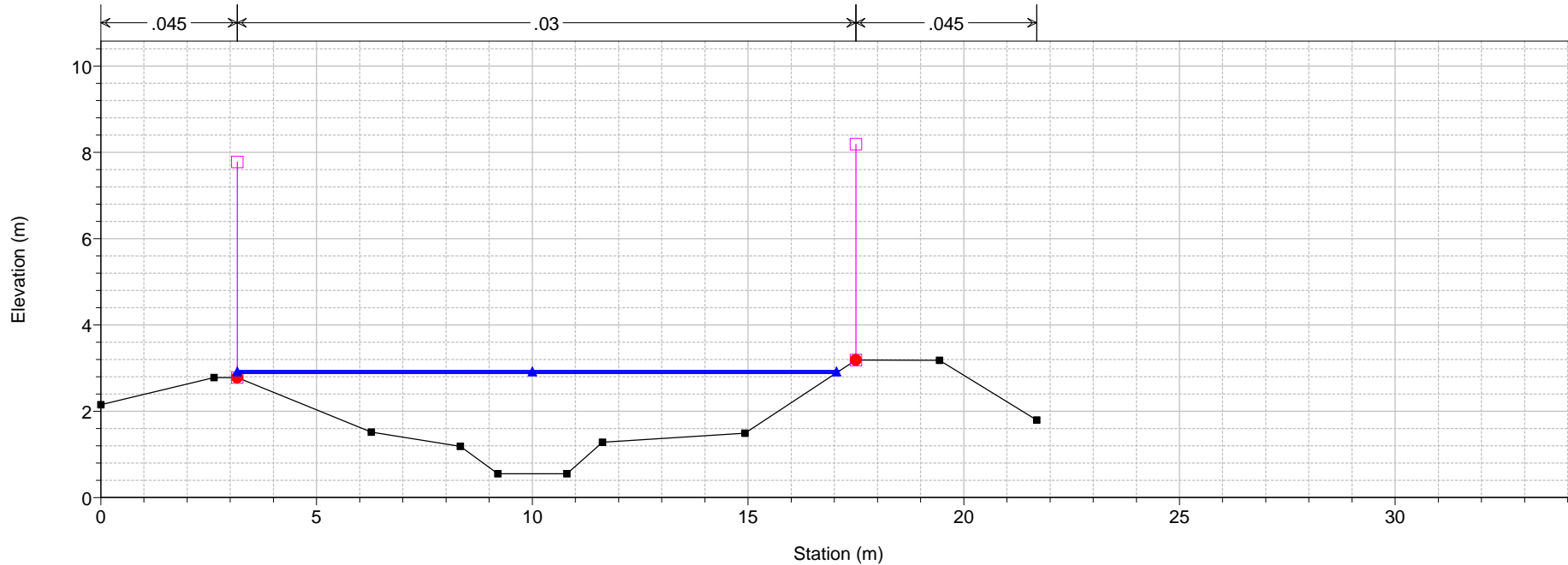

Tripesce Plan: 1) TR200 3H 1/8/19 2) TR303H 1/8/19

Interpolata

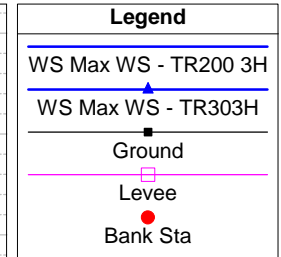
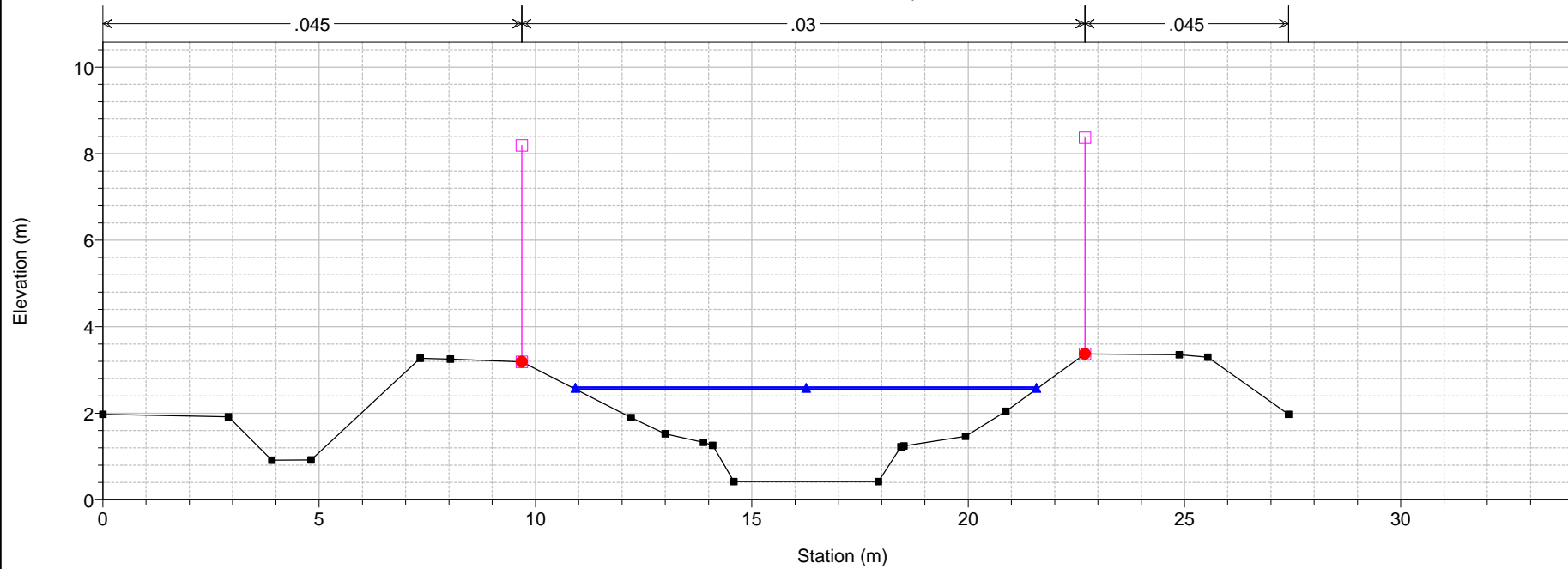

Tripesce Plan: 1) TR200 3H 1/8/19 2) TR303H 1/8/19

Interpolata

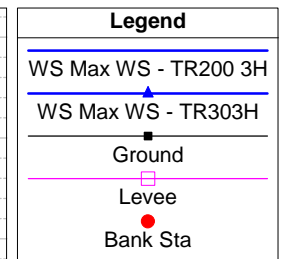
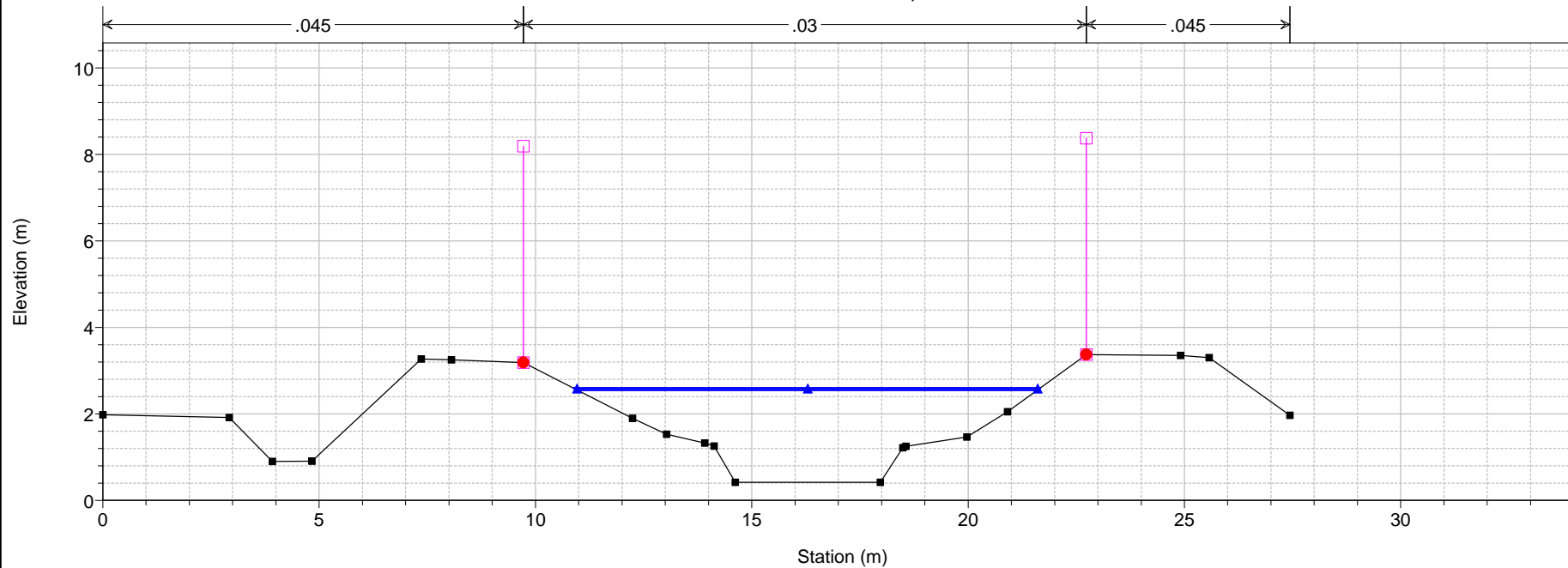

1 cm Horiz. = 1.5 m 1 cm Vert. = 1.5 m

Tripesce Plan: 1) TR200 3H 1/8/19 2) TR303H 1/8/19

Sez. 4 new

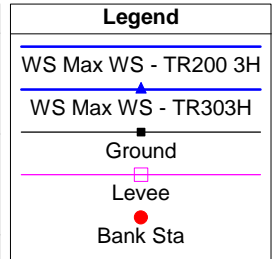
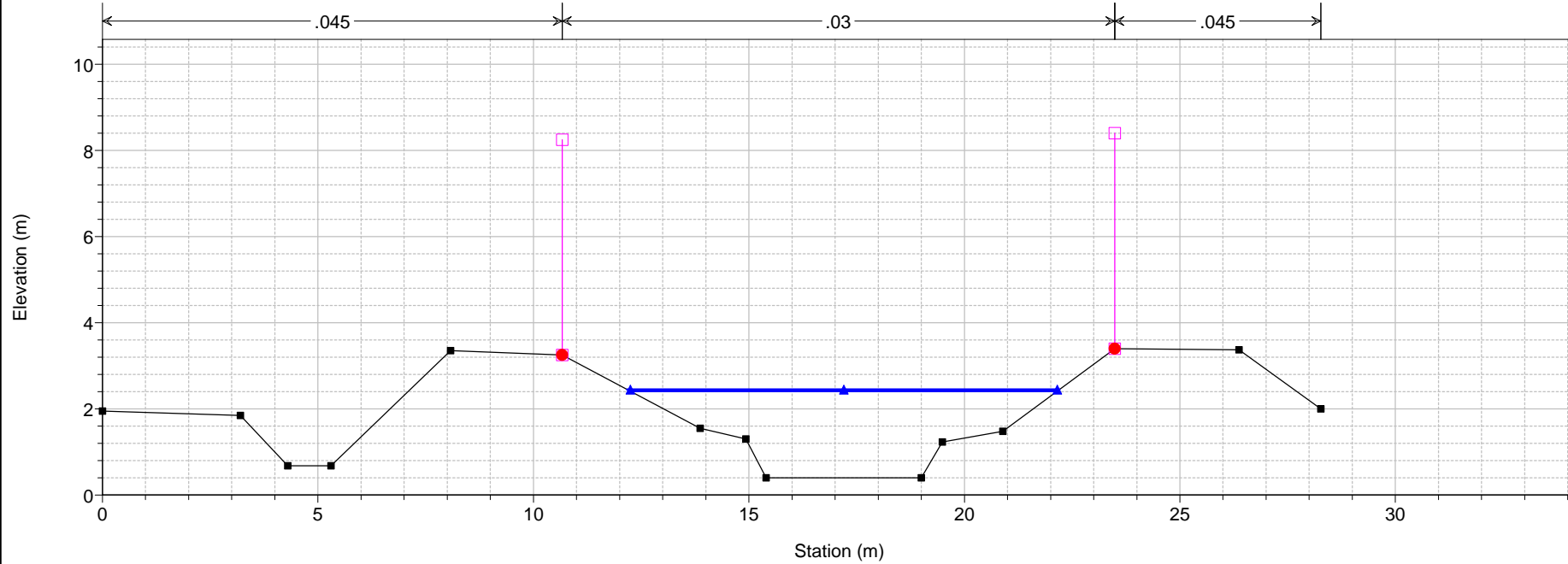

Tripesce Plan: 1) TR200 3H 1/8/19 2) TR303H 1/8/19

Sez. 3.3 new

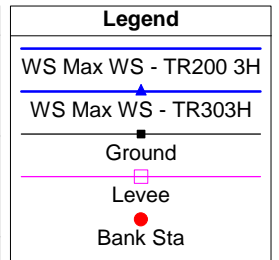
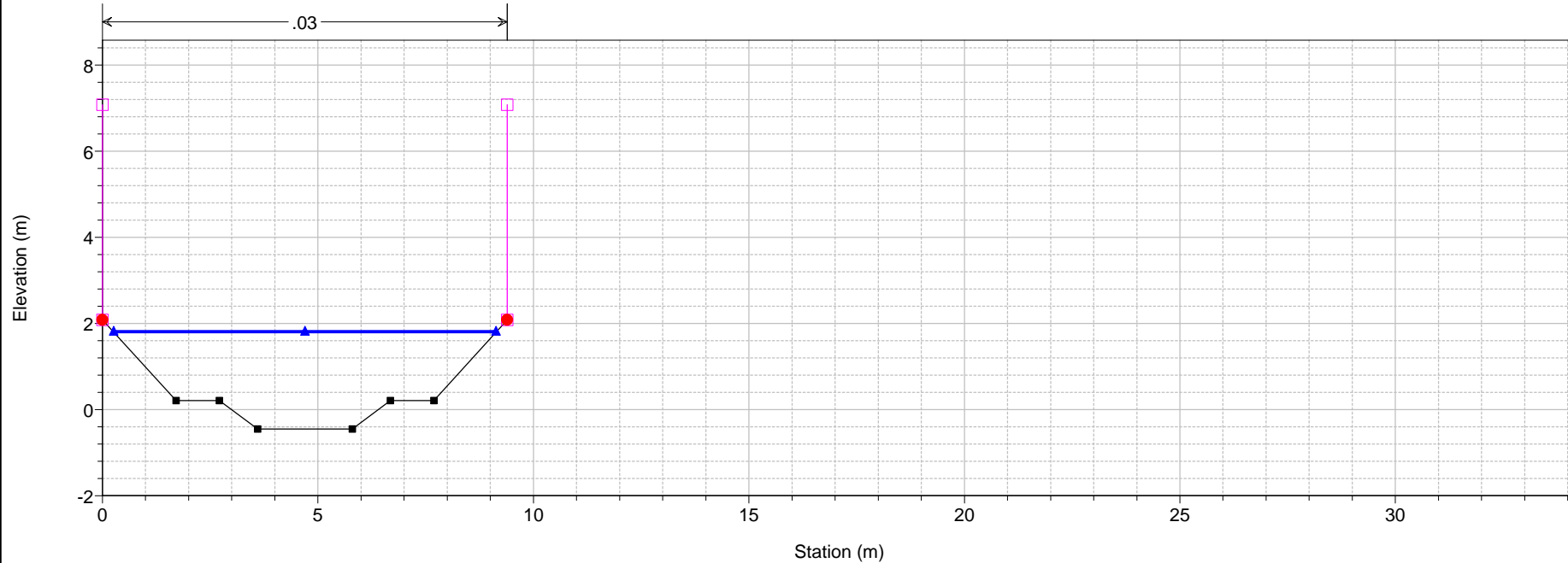

Tripesce Plan: 1) TR200 3H 1/8/19 2) TR303H 1/8/19

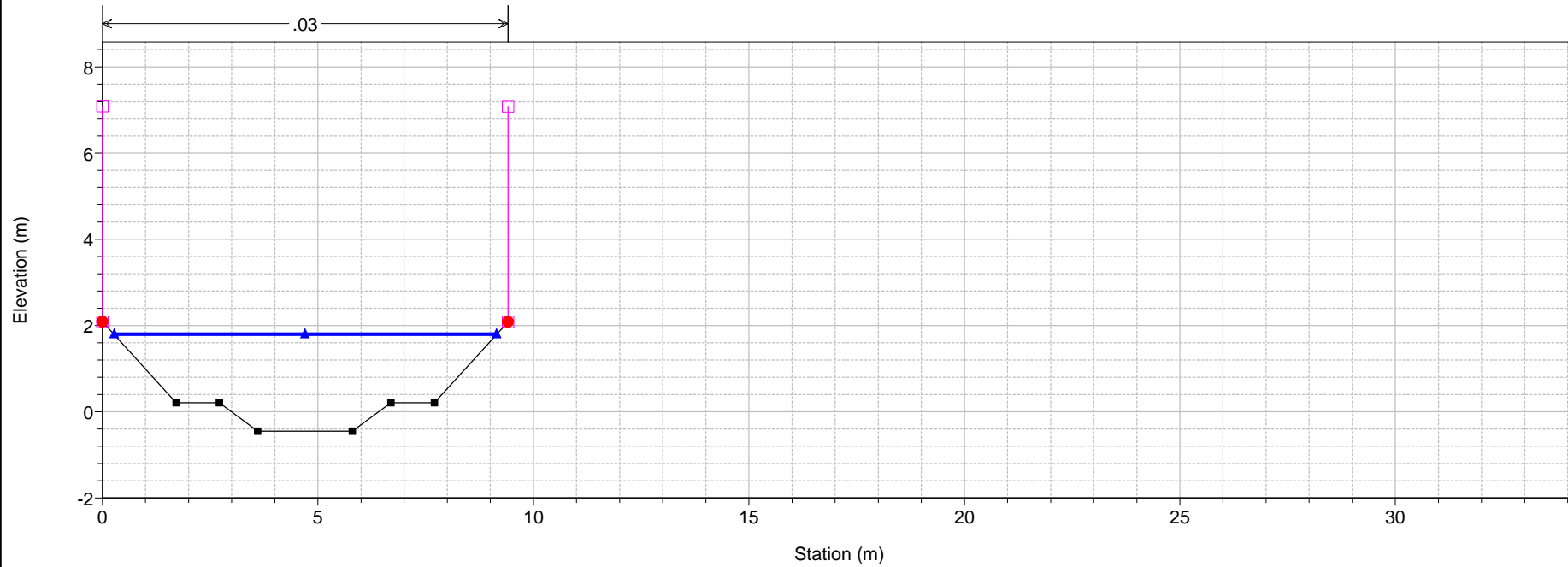

Tripesce Plan: 1) TR200 3H 1/8/19 2) TR303H 1/8/19

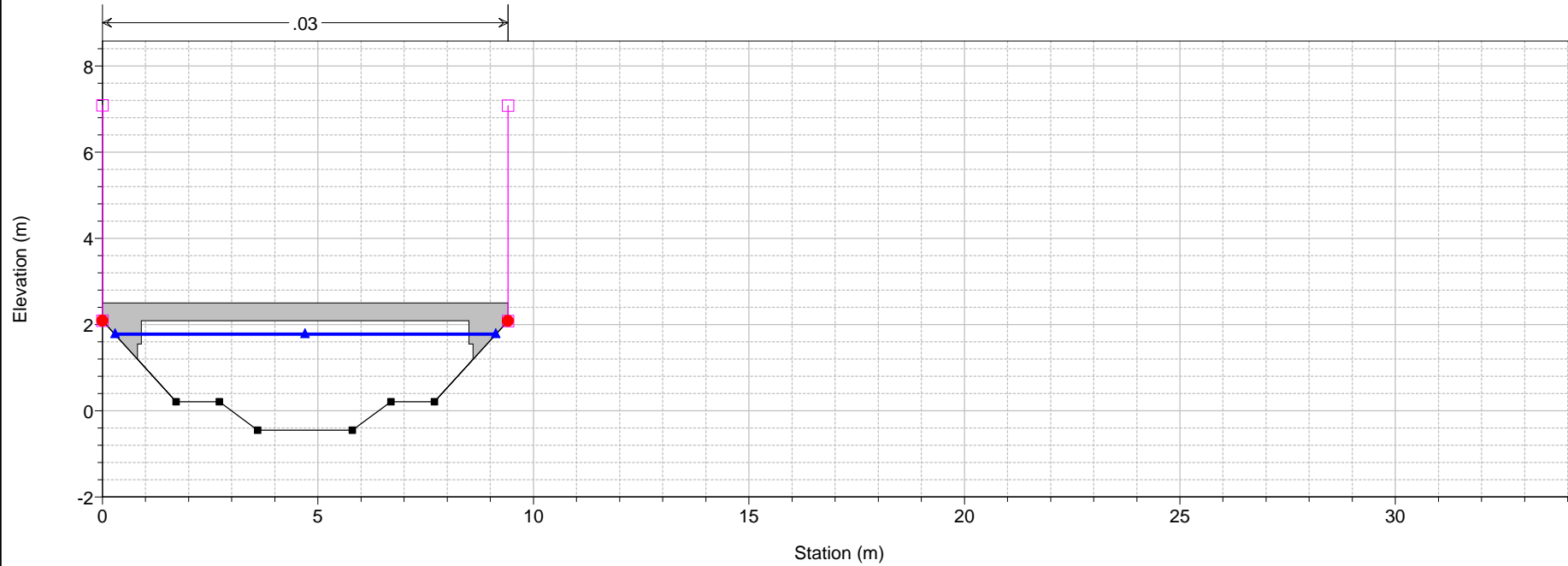

1 cm Horiz. = 1.5 m 1 cm Vert. = 1.5 m

Tripesce Plan: 1) TR200 3H 1/8/19 2) TR303H 1/8/19

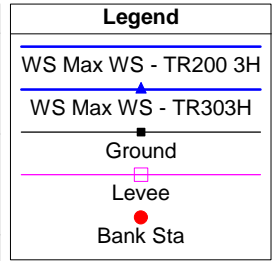
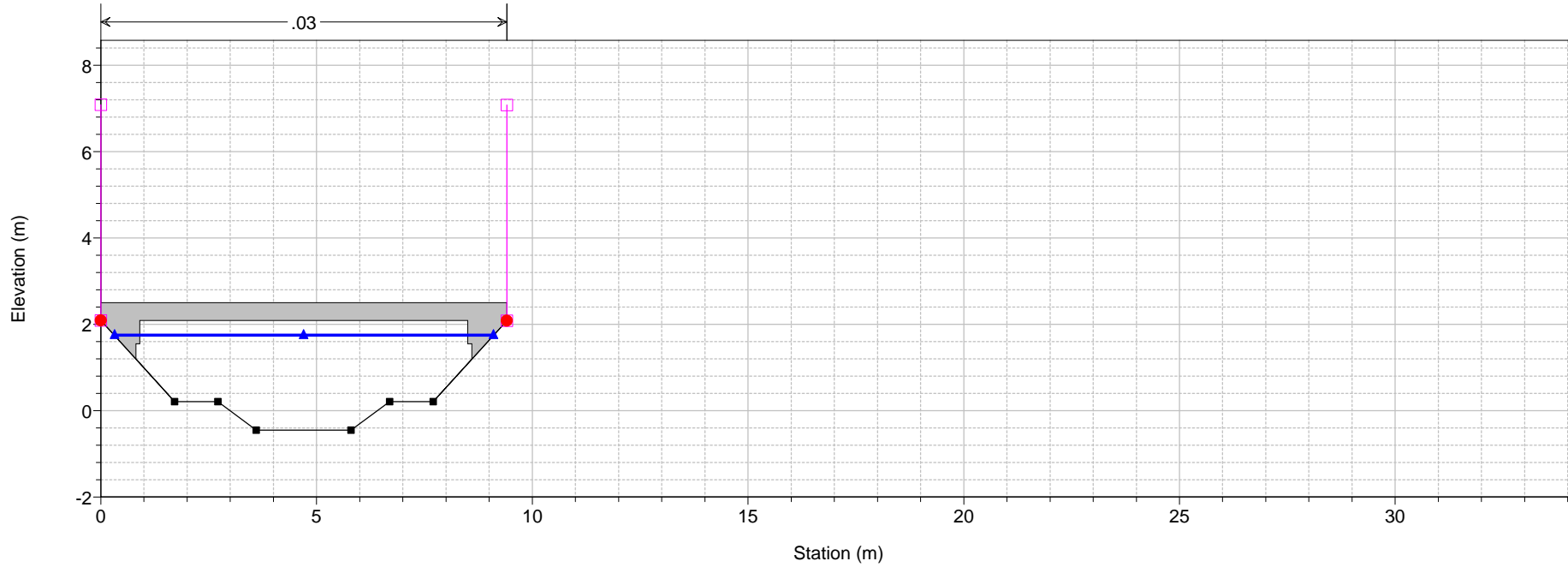

Tripesce Plan: 1) TR200 3H 1/8/19 2) TR303H 1/8/19

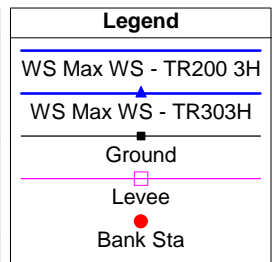
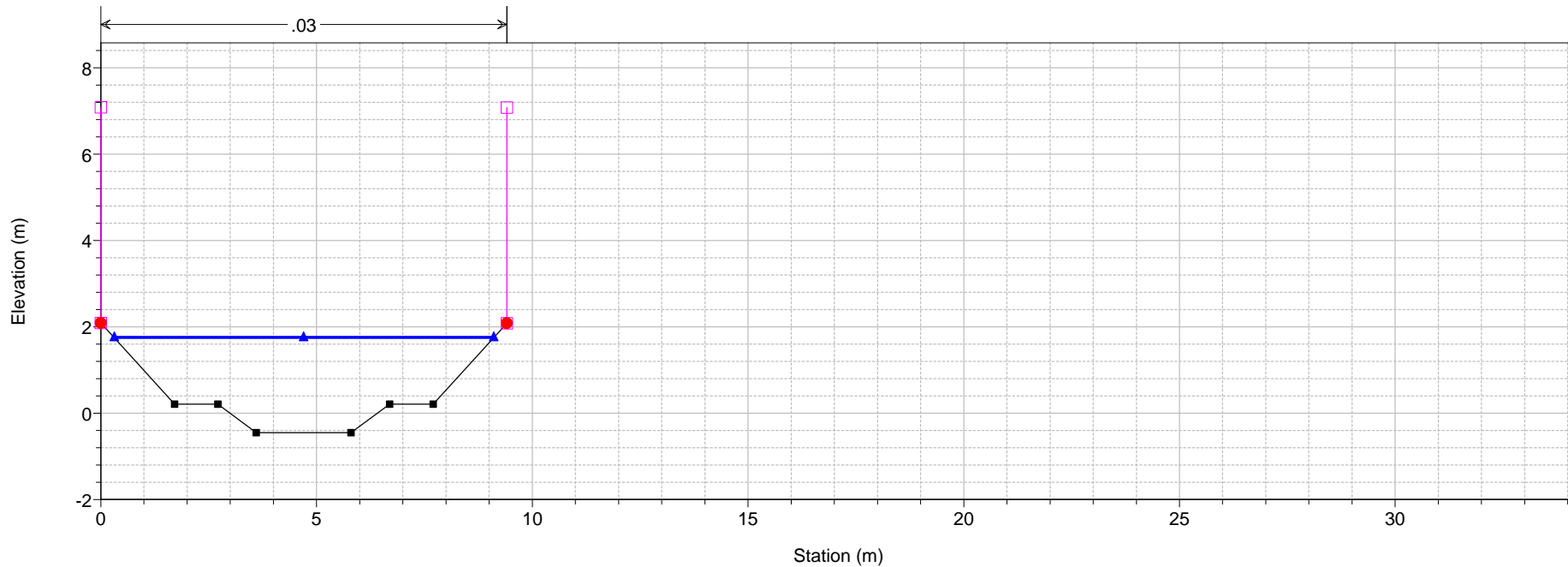

1 cm Horiz. = 1.5 m 1 cm Vert. = 1.5 m

Tripesce Plan: 1) TR200 3H 1/8/19 2) TR303H 1/8/19
Sez. 3 new

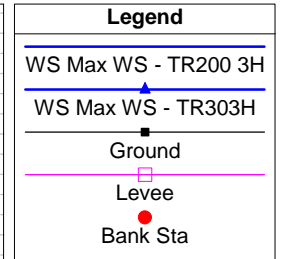
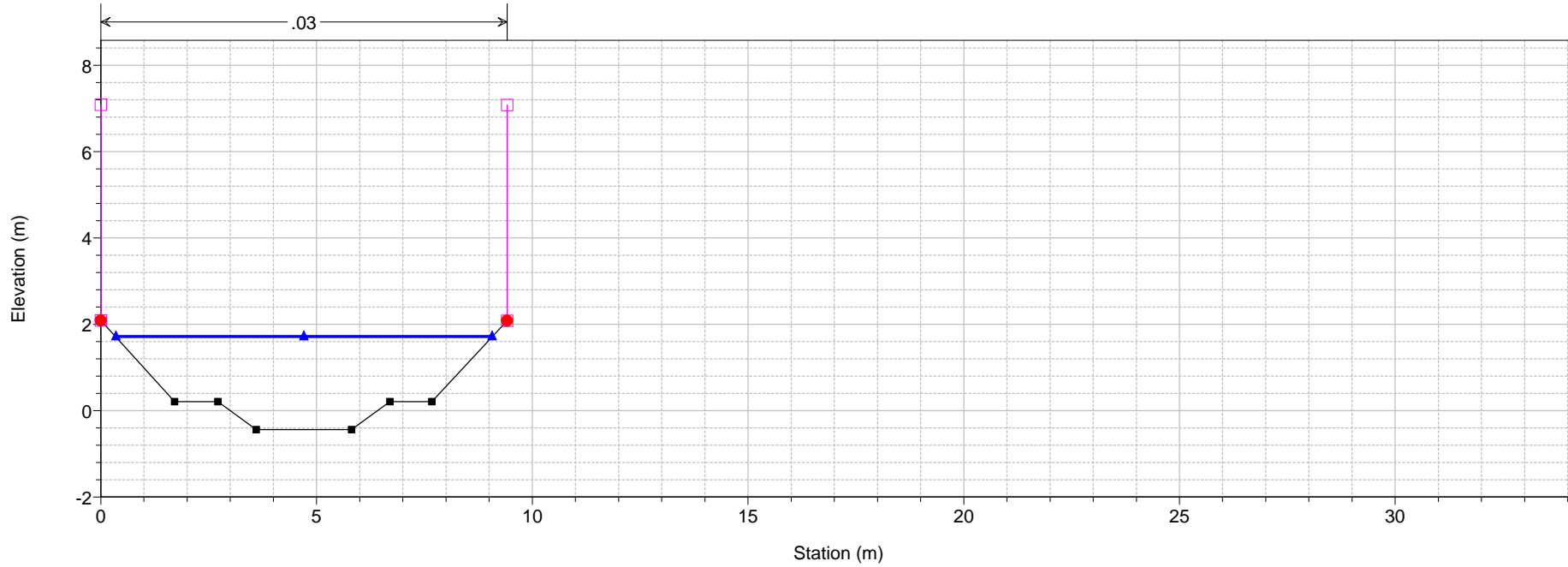

Tripesce Plan: 1) TR200 3H 1/8/19 2) TR303H 1/8/19
Sez. 2 new

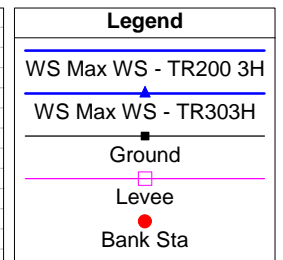
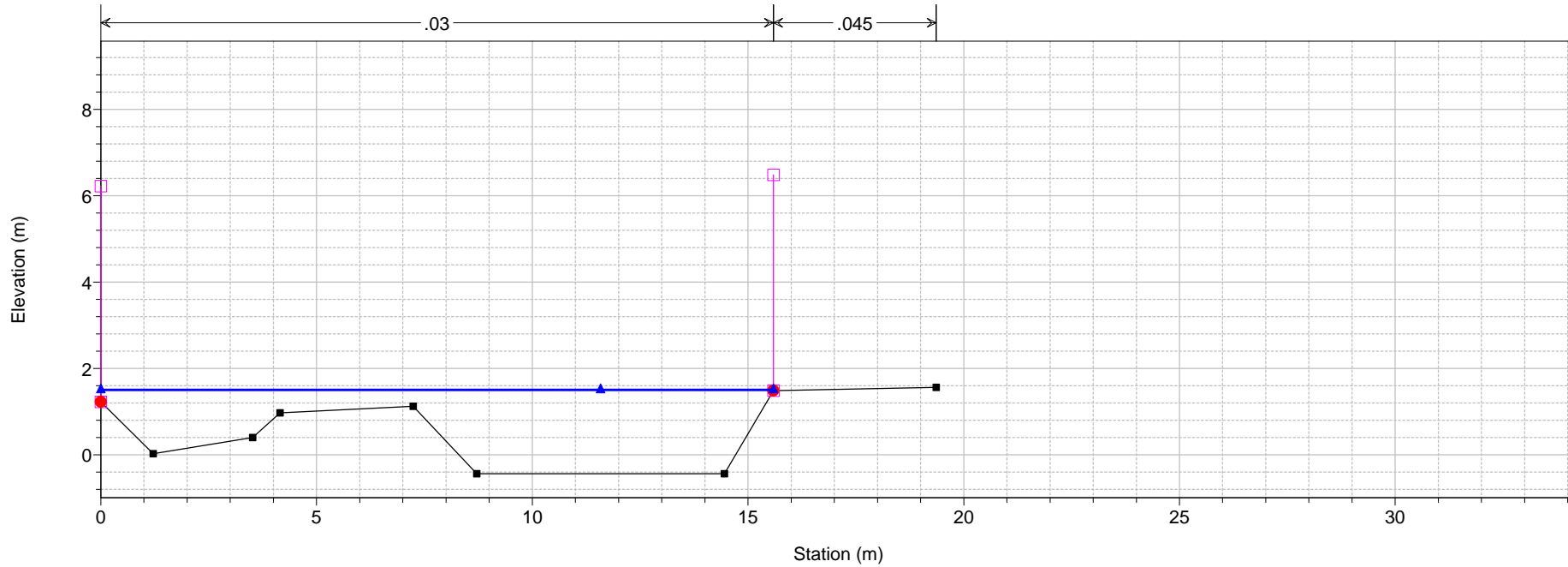

Reach	River Sta	Profile	Plan	Q Total (m3/s)	Min Ch El (m)	W.S. Elev (m)	Crit W.S. (m)	E.G. Elev (m)	E.G. Slope (m/m)	Vel Chnl (m/s)	Flow Area (m2)	Top Width (m)	Froude # Chl
Tripesce_monte	46	Max WS	TR200 3H	69.59	22.20	25.41	25.33	26.10	0.011975	3.67	18.96	11.70	0.92
Tripesce_monte	46	Max WS	TR303H	42.82	22.20	25.14	24.76	25.52	0.008058	2.72	15.72	11.70	0.75
Tripesce_monte	45.99			Lat Struct									
Tripesce_monte	45.98			Lat Struct									
Tripesce_monte	45	Max WS	TR200 3H	45.18	21.73	24.82	24.59	25.38	0.011133	3.33	13.57	9.02	0.87
Tripesce_monte	45	Max WS	TR303H	36.98	21.73	24.44	24.25	25.06	0.012323	3.49	10.61	6.76	0.89
Tripesce_monte	44	Max WS	TR200 3H	44.38	20.78	24.44	23.01	24.84	0.001784	2.77	16.00	14.24	0.47
Tripesce_monte	44	Max WS	TR303H	36.98	20.78	24.09	22.76	24.43	0.001749	2.56	14.43	10.36	0.45
Tripesce_monte	43.5			Bridge									
Tripesce_monte	43	Max WS	TR200 3H	44.38	20.78	23.81	23.02	24.39	0.003432	3.38	13.14	9.50	0.63
Tripesce_monte	43	Max WS	TR303H	36.98	20.78	23.73	22.77	24.15	0.002604	2.89	12.80	9.26	0.54
Tripesce_monte	42.99			Lat Struct									
Tripesce_monte	42.98			Lat Struct									
Tripesce_monte	42	Max WS	TR200 3H	44.36	20.70	23.81	23.34	24.20	0.009306	2.76	16.07	13.41	0.81
Tripesce_monte	42	Max WS	TR303H	36.98	20.70	23.72	23.10	24.04	0.008117	2.48	14.94	13.33	0.75
Tripesce_monte	41	Max WS	TR200 3H	34.23	20.58	23.07	23.03	23.49	0.013655	2.86	11.96	12.74	0.94
Tripesce_monte	41	Max WS	TR303H	31.71	20.58	22.99	22.99	23.42	0.015140	2.89	10.98	12.50	0.98
Tripesce_monte	40	Max WS	TR200 3H	31.56	19.18	22.35	21.41	22.57	0.004955	2.11	14.99	11.30	0.58
Tripesce_monte	40	Max WS	TR303H	31.02	19.18	22.30	21.40	22.53	0.004889	2.15	14.44	10.27	0.58
Tripesce_monte	39	Max WS	TR200 3H	31.56	18.93	21.80	20.98	22.05	0.003962	2.20	14.37	8.20	0.53
Tripesce_monte	39	Max WS	TR303H	31.02	18.93	21.76	20.96	22.01	0.004022	2.21	14.01	7.94	0.53
Tripesce_monte	38.98			Lat Struct									
Tripesce_monte	38	Max WS	TR200 3H	31.50	18.13	21.35	20.54	21.65	0.008488	2.42	13.04	11.65	0.73
Tripesce_monte	38	Max WS	TR303H	31.02	18.13	21.33	20.51	21.63	0.008817	2.43	12.76	11.63	0.74
Tripesce_monte	37	Max WS	TR200 3H	28.25	17.74	20.81	19.75	20.94	0.002866	1.63	17.34	13.28	0.46
Tripesce_monte	37	Max WS	TR303H	28.05	17.74	20.80	19.74	20.94	0.002859	1.62	17.28	13.28	0.45
Tripesce_monte	36	Max WS	TR200 3H	26.99	17.93	20.19	19.96	20.71	0.011152	3.21	8.42	5.44	0.82
Tripesce_monte	36	Max WS	TR303H	26.88	17.93	20.18	19.96	20.71	0.011152	3.20	8.39	5.44	0.82
Tripesce_monte	35.99			Lat Struct									
Tripesce_monte	35.98			Lat Struct									
Tripesce_monte	35	Max WS	TR200 3H	26.99	16.47	18.44	18.60	19.37	0.024129	4.28	6.30	4.52	1.16
Tripesce_monte	35	Max WS	TR303H	26.88	16.47	18.43	18.60	19.37	0.024123	4.28	6.28	4.52	1.16
Tripesce_monte	34	Max WS	TR200 3H	26.99	14.91	17.03	16.61	17.33	0.005779	2.42	11.13	7.99	0.66
Tripesce_monte	34	Max WS	TR303H	26.88	14.91	17.03	16.61	17.33	0.005781	2.42	11.10	7.98	0.66
Tripesce_monte	33	Max WS	TR200 3H	26.99	14.06	16.42	15.79	16.65	0.003996	2.12	12.71	8.28	0.55
Tripesce_monte	33	Max WS	TR303H	26.88	14.06	16.42	15.78	16.65	0.003994	2.12	12.67	8.27	0.55
Tripesce_monte	32	Max WS	TR200 3H	26.99	13.62	15.57	15.33	15.96	0.008255	2.77	9.75	7.51	0.78
Tripesce_monte	32	Max WS	TR303H	26.88	13.62	15.57	15.32	15.96	0.008259	2.77	9.72	7.50	0.78
Tripesce_monte	31.99			Lat Struct									
Tripesce_monte	31.98			Lat Struct									
Tripesce_monte	31	Max WS	TR200 3H	26.99	13.00	15.07	14.71	15.39	0.006498	2.53	10.66	7.84	0.69
Tripesce_monte	31	Max WS	TR303H	26.88	13.00	15.06	14.70	15.39	0.006499	2.53	10.63	7.83	0.69
Tripesce_monte	30	Max WS	TR200 3H	26.99	12.29	14.36	13.97	14.66	0.006022	2.45	11.04	8.19	0.67
Tripesce_monte	30	Max WS	TR303H	26.88	12.29	14.35	13.97	14.66	0.006019	2.44	11.01	8.18	0.67
Tripesce_monte	29	Max WS	TR200 3H	26.99	11.63	13.53	13.26	13.86	0.007272	2.57	10.51	8.60	0.74
Tripesce_monte	29	Max WS	TR303H	26.88	11.63	13.52	13.25	13.86	0.007275	2.56	10.48	8.59	0.74
Tripesce_monte	28	Max WS	TR200 3H	26.99	10.54	12.91	12.19	13.12	0.003469	2.01	13.41	8.40	0.51
Tripesce_monte	28	Max WS	TR303H	26.88	10.54	12.91	12.19	13.12	0.003456	2.01	13.38	8.40	0.51
Tripesce_monte	27	Max WS	TR200 3H	26.94	10.12	12.76	11.69	12.87	0.002999	1.46	18.41	18.73	0.47
Tripesce_monte	27	Max WS	TR303H	26.83	10.12	12.76	11.69	12.86	0.002991	1.46	18.38	18.71	0.47
Tripesce_monte	26	Max WS	TR200 3H	25.25	9.75	12.56	11.26	12.63	0.001824	1.13	22.32	23.31	0.37
Tripesce_monte	26	Max WS	TR303H	25.22	9.75	12.56	11.26	12.63	0.001819	1.13	22.30	23.22	0.37
Tripesce_monte	25.99			Lat Struct									
Tripesce_monte	25.98			Lat Struct									
Tripesce_monte	25	Max WS	TR200 3H	25.25	9.35	12.30	10.88	12.35	0.001137	0.96	26.40	24.93	0.30
Tripesce_monte	25	Max WS	TR303H	25.22	9.35	12.30	10.88	12.34	0.001139	0.96	26.36	24.93	0.30
Tripesce_monte	24	Max WS	TR200 3H	25.25	9.05	12.25	10.50	12.29	0.000435	0.83	30.36	16.80	0.20
Tripesce_monte	24	Max WS	TR303H	25.22	9.05	12.25	10.50	12.29	0.000435	0.83	30.33	16.79	0.20

Reach	River Sta	Profile	Plan	Q Total (m3/s)	Min Ch El (m)	W.S. Elev (m)	Crit W.S. (m)	E.G. Elev (m)	E.G. Slope (m/m)	Vel Chnl (m/s)	Flow Area (m2)	Top Width (m)	Froude # Chl
Tripesce_monte	17	Max WS	TR200 3H	25.25	9.42	12.13	11.01	12.24	0.001538	1.44	17.51	10.26	0.35
Tripesce_monte	17	Max WS	TR303H	25.22	9.42	12.13	11.01	12.24	0.001538	1.44	17.50	10.26	0.35
Tripesce_monte	16	Max WS	TR200 3H	25.25	9.48	11.83	11.09	12.02	0.003218	1.93	13.08	8.35	0.49
Tripesce_monte	16	Max WS	TR303H	25.22	9.48	11.83	11.09	12.02	0.003217	1.93	13.07	8.34	0.49
Tripesce_monte	15	Max WS	TR200 3H	25.25	9.44	11.10	11.08	11.64	0.013563	3.27	7.73	6.81	0.98
Tripesce_monte	15	Max WS	TR303H	25.22	9.44	11.09	11.08	11.64	0.013569	3.27	7.72	6.81	0.98
Tripesce_monte	14.99			Lat Struct									
Tripesce_monte	14.98			Lat Struct									
Tripesce_monte	14	Max WS	TR200 3H	25.25	8.98	10.88	10.28	11.05	0.003118	1.81	13.99	10.58	0.50
Tripesce_monte	14	Max WS	TR303H	25.22	8.98	10.88	10.28	11.05	0.003116	1.80	13.98	10.58	0.50
Tripesce_monte	13	Max WS	TR200 3H	25.25	8.65	10.70	9.98	10.85	0.001838	1.67	15.10	10.80	0.45
Tripesce_monte	13	Max WS	TR303H	25.22	8.65	10.70	9.98	10.85	0.001835	1.67	15.10	10.80	0.45
Tripesce_monte	12	Max WS	TR200 3H	25.22	8.10	10.35	9.76	10.57	0.002942	2.06	12.24	8.60	0.55
Tripesce_monte	12	Max WS	TR303H	25.22	8.10	10.35	9.77	10.57	0.002950	2.06	12.23	8.59	0.55
Tripesce_monte	11	Max WS	TR200 3H	22.37	7.59	10.38	8.75	10.44	0.000529	1.09	20.54	9.08	0.23
Tripesce_monte	11	Max WS	TR303H	22.41	7.59	10.38	8.75	10.44	0.000532	1.09	20.52	9.08	0.23
Tripesce_monte	10.99	Max WS	TR200 3H	14.16	7.59	10.43	8.46	10.48	0.000188	0.90	15.79	9.08	0.17
Tripesce_monte	10.99	Max WS	TR303H	14.28	7.59	10.43	8.47	10.47	0.000192	0.91	15.78	9.08	0.17
Tripesce_monte	10.95			Bridge									
Tripesce_monte	10.91	Max WS	TR200 3H	14.15	7.58	10.20	8.46	10.25	0.000251	0.99	14.32	9.06	0.20
Tripesce_monte	10.91	Max WS	TR303H	14.28	7.58	10.19	8.47	10.25	0.000258	1.00	14.29	9.06	0.20
Tripesce_monte	10.909			Lat Struct									
Tripesce_monte	10.908			Lat Struct									
Tripesce_monte	10.9	Max WS	TR200 3H	13.00	7.57	10.23	8.39	10.25	0.000214	0.67	19.28	9.06	0.15
Tripesce_monte	10.9	Max WS	TR303H	13.23	7.57	10.22	8.40	10.25	0.000224	0.69	19.21	9.06	0.15
Tripesce_monte	10.3	Max WS	TR200 3H	11.58	7.53	10.14	8.76	10.22	0.001343	1.31	8.86	4.34	0.29
Tripesce_monte	10.3	Max WS	TR303H	11.70	7.53	10.12	8.77	10.21	0.001399	1.33	8.79	4.33	0.30
Tripesce_monte	10.21	Max WS	TR200 3H	11.56	7.52	10.05	8.79	10.21	0.000969	1.75	6.60	4.24	0.35
Tripesce_monte	10.21	Max WS	TR303H	11.59	7.52	10.04	8.79	10.20	0.000991	1.77	6.57	4.23	0.36
Tripesce_monte	10.2			Bridge									
Tripesce_monte	10.19	Max WS	TR200 3H	12.00	7.51	9.41	8.81	9.71	0.002730	2.43	4.95	3.80	0.56
Tripesce_monte	10.19	Max WS	TR303H	11.87	7.51	9.39	8.80	9.69	0.002769	2.43	4.89	3.78	0.57
Tripesce_monte	10	Max WS	TR200 3H	11.74	7.50	9.35	8.75	9.56	0.004377	2.06	5.71	3.77	0.53
Tripesce_monte	10	Max WS	TR303H	11.80	7.50	9.33	8.76	9.55	0.004586	2.09	5.64	3.75	0.55
Tripesce_monte	9.99			Lat Struct									
Tripesce_monte	9.98			Lat Struct									
Tripesce_monte	9	Max WS	TR200 3H	14.23	6.15	7.88	7.63	8.06	0.004471	1.88	7.57	8.62	0.64
Tripesce_monte	9	Max WS	TR303H	13.46	6.15	7.84	7.60	8.02	0.004633	1.87	7.20	8.52	0.65
Tripesce_monte	8.3	Max WS	TR200 3H	16.59	4.99	6.77	6.24	6.89	0.002118	1.52	10.93	9.30	0.45
Tripesce_monte	8.3	Max WS	TR303H	14.99	4.99	6.68	6.19	6.79	0.002173	1.48	10.13	9.17	0.45
Tripesce_monte	8.21	Max WS	TR200 3H	16.69	4.98	6.71	6.24	6.86	0.002421	1.71	9.77	9.19	0.50
Tripesce_monte	8.21	Max WS	TR303H	15.06	4.98	6.63	6.19	6.77	0.002435	1.66	9.08	9.07	0.50
Tripesce_monte	8.2			Bridge									
Tripesce_monte	8.19	Max WS	TR200 3H	16.68	4.98	6.66	6.25	6.82	0.002771	1.79	9.32	9.13	0.53
Tripesce_monte	8.19	Max WS	TR303H	15.06	4.98	6.58	6.20	6.73	0.002807	1.74	8.66	9.01	0.53
Tripesce_monte	8	Max WS	TR200 3H	16.75	4.98	6.64	6.24	6.79	0.003026	1.71	9.77	9.09	0.53
Tripesce_monte	8	Max WS	TR303H	15.11	4.98	6.56	6.19	6.70	0.003156	1.68	9.00	8.97	0.54
Tripesce_monte	7.99			Lat Struct									
Tripesce_monte	7.98			Lat Struct									
Tripesce_monte	7	Max WS	TR200 3H	19.80	3.69	5.49	5.04	5.63	0.002548	1.67	11.88	10.76	0.51
Tripesce_monte	7	Max WS	TR303H	17.06	3.69	5.36	4.97	5.50	0.002716	1.62	10.52	10.46	0.52
Tripesce_monte	6.3	Max WS	TR200 3H	22.23	2.67	4.71	4.13	4.86	0.002206	1.69	13.16	9.97	0.47
Tripesce_monte	6.3	Max WS	TR303H	18.61	2.67	4.56	4.03	4.69	0.002198	1.59	11.67	9.69	0.46
Tripesce_monte	6.21	Max WS	TR200 3H	22.29	2.68	4.66	4.18	4.85	0.003018	1.93	11.52	9.91	0.54
Tripesce_monte	6.21	Max WS	TR303H	18.65	2.68	4.52	4.06	4.69	0.002984	1.82	10.23	9.63	0.54
Tripesce_monte	6.2			Bridge									
Tripesce_monte	6.19	Max WS	TR200 3H	22.29	2.67	4.41	4.18	4.70	0.005666	2.40	9.27	9.39	0.73

HEC-RAS Profile: Max WS (Continued)

Reach	River Sta	Profile	Plan	Q Total (m3/s)	Min Ch El (m)	W.S. Elev (m)	Crit W.S. (m)	E.G. Elev (m)	E.G. Slope (m/m)	Vel Chnl (m/s)	Flow Area (m2)	Top Width (m)	Froude # Chl
Tripesce_monte	6.19	Max WS	TR303H	18.65	2.67	4.29	4.07	4.55	0.005568	2.26	8.26	9.16	0.72
Tripesce_monte	6	Max WS	TR200 3H	22.36	2.67	4.38	4.13	4.63	0.005156	2.25	9.92	9.37	0.70
Tripesce_monte	6	Max WS	TR303H	18.69	2.67	4.25	4.03	4.48	0.005221	2.13	8.76	9.14	0.70
Tripesce_monte	5.99			Lat Struct									
Tripesce_monte	5.98			Lat Struct									
Tripesce_monte	5	Max WS	TR200 3H	24.50	0.55	2.94	2.07	3.01	0.000996	1.24	19.69	13.96	0.33
Tripesce_monte	5	Max WS	TR303H	20.24	0.55	2.89	1.96	2.95	0.000747	1.06	19.08	13.89	0.29
Tripesce_monte	4.9	Max WS	TR200 3H	20.30	0.42	2.60	1.82	2.70	0.001464	1.41	14.38	10.79	0.39
Tripesce_monte	4.9	Max WS	TR303H	18.59	0.42	2.56	1.76	2.65	0.001338	1.33	13.94	10.65	0.37
Tripesce_valle	4.1	Max WS	TR200 3H	24.23	0.42	2.60	1.94	2.74	0.002082	1.68	14.39	10.78	0.47
Tripesce_valle	4.1	Max WS	TR303H	23.17	0.42	2.56	1.91	2.70	0.002075	1.66	13.95	10.65	0.46
Tripesce_valle	4.09			Lat Struct									
Tripesce_valle	4.08			Lat Struct									
Tripesce_valle	4	Max WS	TR200 3H	24.23	0.40	2.45	1.90	2.63	0.002721	1.87	12.97	10.03	0.52
Tripesce_valle	4	Max WS	TR303H	23.17	0.40	2.41	1.86	2.59	0.002711	1.84	12.58	9.91	0.52
Tripesce_valle	3.3	Max WS	TR200 3H	24.23	-0.45	1.83	1.04	1.98	0.001871	1.72	14.08	8.93	0.44
Tripesce_valle	3.3	Max WS	TR303H	23.17	-0.45	1.80	1.01	1.94	0.001795	1.67	13.84	8.88	0.43
Tripesce_valle	3.21	Max WS	TR200 3H	24.23	-0.45	1.81	1.04	1.97	0.001905	1.73	13.99	8.91	0.44
Tripesce_valle	3.21	Max WS	TR303H	23.17	-0.45	1.79	1.01	1.93	0.001826	1.68	13.75	8.87	0.43
Tripesce_valle	3.2			Bridge									
Tripesce_valle	3.19	Max WS	TR200 3H	24.23	-0.45	1.77	1.04	1.93	0.002072	1.78	13.58	8.83	0.46
Tripesce_valle	3.19	Max WS	TR303H	23.17	-0.45	1.74	1.01	1.90	0.001974	1.73	13.38	8.79	0.45
Tripesce_valle	3	Max WS	TR200 3H	24.23	-0.44	1.73	1.05	1.90	0.002252	1.84	13.17	8.76	0.48
Tripesce_valle	3	Max WS	TR303H	23.17	-0.44	1.71	1.02	1.87	0.002138	1.78	13.00	8.72	0.47
Tripesce_valle	2.99			Lat Struct									
Tripesce_valle	2.98			Lat Struct									
Tripesce_valle	2	Max WS	TR200 3H	2.00	-0.44	1.50	-0.21	1.50	0.000008	0.10	19.92	15.59	0.03
Tripesce_valle	2	Max WS	TR303H	2.00	-0.44	1.50	-0.21	1.50	0.000008	0.10	19.92	15.59	0.03

Reach	River Sta	Profile	Plan	Q US (m3/s)	Q Leaving Total (m3/s)	Q DS (m3/s)	Q Weir (m3/s)	Q Gates (m3/s)	Wr Top Width (m)	Weir Max Depth (m)	Weir Avg Depth (m)	Min El Weir Flow (m)	E.G. US. (m)	W.S. US. (m)	E.G. DS (m)	W.S. DS (m)	
Tripesce_monte	45.99	Max WS	TR200 3H	69.59	7.05	44.38	7.05		47.56	0.45	0.17		24.30	26.10	25.41	24.84	24.45
Tripesce_monte	45.99	Max WS	TR303H	42.82	0.63	36.98	0.63		12.44	0.18	0.09		24.30	25.51	25.14	24.43	24.09
Tripesce_monte	45.98	Max WS	TR200 3H	69.59	18.15	44.38	18.15		44.76	0.68	0.36		24.73	26.10	25.41	24.84	24.45
Tripesce_monte	45.98	Max WS	TR303H	42.82	5.20	36.98	5.20		26.89	0.41	0.22		24.73	25.51	25.14	24.43	24.09
Tripesce_monte	42.99	Max WS	TR200 3H	44.38	2.33	26.99	2.33		38.10	0.21	0.10		20.60	24.39	23.81	20.71	20.19
Tripesce_monte	42.99	Max WS	TR303H	36.98	2.21	26.88	2.21		37.08	0.20	0.10		20.60	24.15	23.73	20.71	20.18
Tripesce_monte	42.98	Max WS	TR200 3H	44.38	12.82	31.56	12.82		105.35	0.23	0.16		22.12	24.39	23.81	22.05	21.80
Tripesce_monte	42.98	Max WS	TR303H	36.98	5.95	31.02	5.95		85.01	0.17	0.11		22.12	24.15	23.73	22.01	21.76
Tripesce_monte	38.98	Max WS	TR200 3H	31.56	2.23	26.99	2.23		110.67	0.17	0.04		20.64	22.05	21.80	20.71	20.19
Tripesce_monte	38.98	Max WS	TR303H	31.02	1.94	26.88	1.94		71.72	0.16	0.05		20.64	22.01	21.76	20.71	20.19
Tripesce_monte	35.99	Max WS	TR200 3H	26.99	0.00	26.99	0.00						16.15	20.71	20.19	15.96	15.57
Tripesce_monte	35.99	Max WS	TR303H	26.88	0.00	26.88	0.00						16.15	20.71	20.18	15.96	15.57
Tripesce_monte	35.98	Max WS	TR200 3H	26.99	0.00	26.99	0.00						17.08	20.71	20.19	15.96	15.57
Tripesce_monte	35.98	Max WS	TR303H	26.88	0.00	26.88	0.00						17.08	20.71	20.18	15.96	15.57
Tripesce_monte	31.99	Max WS	TR200 3H	26.99	1.74	25.25	1.74		98.11	0.09	0.04		12.55	15.96	15.57	12.63	12.56
Tripesce_monte	31.99	Max WS	TR303H	26.88	1.66	25.22	1.66		98.05	0.09	0.04		12.55	15.95	15.56	12.63	12.56
Tripesce_monte	31.98	Max WS	TR200 3H	26.99	0.00	25.25	0.00						13.07	15.96	15.57	12.63	12.56
Tripesce_monte	31.98	Max WS	TR303H	26.88	0.00	25.22	0.00						13.07	15.95	15.56	12.63	12.56
Tripesce_monte	25.99	Max WS	TR200 3H	25.25	0.00	25.25	0.00						12.55	12.63	12.56	11.64	11.10
Tripesce_monte	25.99	Max WS	TR303H	25.22	0.00	25.22	0.00						12.55	12.63	12.56	11.64	11.09
Tripesce_monte	25.98	Max WS	TR200 3H	25.25	0.00	25.25	0.00						12.49	12.63	12.56	11.64	11.10
Tripesce_monte	25.98	Max WS	TR303H	25.22	0.00	25.22	0.00						12.49	12.63	12.56	11.64	11.10
Tripesce_monte	14.99	Max WS	TR200 3H	25.25	5.34	14.16	5.34		28.48	0.32	0.22		10.11	11.64	11.09	10.48	10.43
Tripesce_monte	14.99	Max WS	TR303H	25.22	5.28	14.28	5.28		28.41	0.32	0.21		10.11	11.64	11.09	10.47	10.43
Tripesce_monte	14.98	Max WS	TR200 3H	25.25	5.72	14.16	5.72		33.32	0.32	0.20		10.11	11.64	11.09	10.48	10.43
Tripesce_monte	14.98	Max WS	TR303H	25.22	5.66	14.28	5.66		33.22	0.32	0.20		10.11	11.64	11.09	10.47	10.43
Tripesce_monte	10.909	Max WS	TR200 3H	14.15	1.30	11.56	1.30		33.83	0.12	0.07		10.11	10.25	10.20	10.21	10.05
Tripesce_monte	10.909	Max WS	TR303H	14.28	1.14	11.59	1.14		32.07	0.11	0.07		10.11	10.25	10.19	10.20	10.04
Tripesce_monte	10.908	Max WS	TR200 3H	14.15	1.30	11.56	1.30		33.83	0.12	0.07		10.11	10.25	10.20	10.21	10.05
Tripesce_monte	10.908	Max WS	TR303H	14.28	1.14	11.59	1.14		32.07	0.11	0.07		10.11	10.25	10.19	10.20	10.04
Tripesce_monte	9.99	Max WS	TR200 3H	11.74	0.00	16.59	0.00						7.88	9.56	9.35	6.89	6.77
Tripesce_monte	9.99	Max WS	TR303H	11.80	0.00	14.99	0.00						7.88	9.55	9.33	6.79	6.68
Tripesce_monte	9.98	Max WS	TR200 3H	11.74	0.00	16.59	0.00						7.88	9.56	9.35	6.89	6.77
Tripesce_monte	9.98	Max WS	TR303H	11.80	0.00	14.99	0.00						7.88	9.55	9.33	6.79	6.68
Tripesce_monte	7.99	Max WS	TR200 3H	16.75	0.00	22.23	0.00						5.37	6.79	6.64	4.86	4.71
Tripesce_monte	7.99	Max WS	TR303H	15.11	0.00	18.61	0.00						5.37	6.70	6.56	4.69	4.56
Tripesce_monte	7.98	Max WS	TR200 3H	16.75	0.00	22.23	0.00						5.37	6.79	6.64	4.86	4.71
Tripesce_monte	7.98	Max WS	TR303H	15.11	0.00	18.61	0.00						5.37	6.70	6.56	4.69	4.56
Tripesce_monte	5.99	Max WS	TR200 3H	22.36	5.20	20.30	5.20		112.70	0.16	0.08		2.78	4.63	4.37	2.70	2.60
Tripesce_monte	5.99	Max WS	TR303H	18.69	2.09	18.59	2.09		77.23	0.11	0.06		2.78	4.48	4.25	2.65	2.56
Tripesce_monte	5.98	Max WS	TR200 3H	22.36	0.00	20.30	0.00						3.19	4.63	4.37	2.70	2.60
Tripesce_monte	5.98	Max WS	TR303H	18.69	0.00	18.59	0.00						3.19	4.48	4.25	2.65	2.56
Tripesce_valle	4.09	Max WS	TR200 3H	24.23	0.00	24.23	0.00						2.08	2.74	2.60	1.98	1.83
Tripesce_valle	4.09	Max WS	TR303H	23.17	0.00	23.17	0.00						2.08	2.70	2.56	1.94	1.80
Tripesce_valle	4.08	Max WS	TR200 3H	24.23	0.00	24.23	0.00						2.08	2.74	2.60	1.98	1.83
Tripesce_valle	4.08	Max WS	TR303H	23.17	0.00	23.17	0.00						2.08	2.70	2.56	1.94	1.80
Tripesce_valle	2.99	Max WS	TR200 3H	24.23	7.72	2.00	7.72		74.58	0.28	0.14		1.22	1.90	1.73	1.50	1.50
Tripesce_valle	2.99	Max WS	TR303H	23.17	7.71	2.00	7.71		74.04	0.28	0.14		1.22	1.87	1.71	1.50	1.50
Tripesce_valle	2.98	Max WS	TR200 3H	24.23	0.00	2.00	0.00						1.56	1.90	1.73	1.50	1.50
Tripesce_valle	2.98	Max WS	TR303H	23.17	0.00	2.00	0.00						1.56	1.87	1.71	1.50	1.50

Fosso Dei Fichi

Stato Attuale



None of the XS's are Geo-Referenced (Geo-Ref user entered XS, Geo-Ref interpolated XS, Non Geo-Ref user entered XS, Non Geo-Ref interpolated XS)

1 cm Horiz. = 108 m 1 cm Vert. = 88 m

1) TR200 3H 1/8/19 2) TR303H 1/8/19

Fosso dei Fichi Fichi

N.B. in grigio sono indicati gli sfioratori laterali in destra idrografica

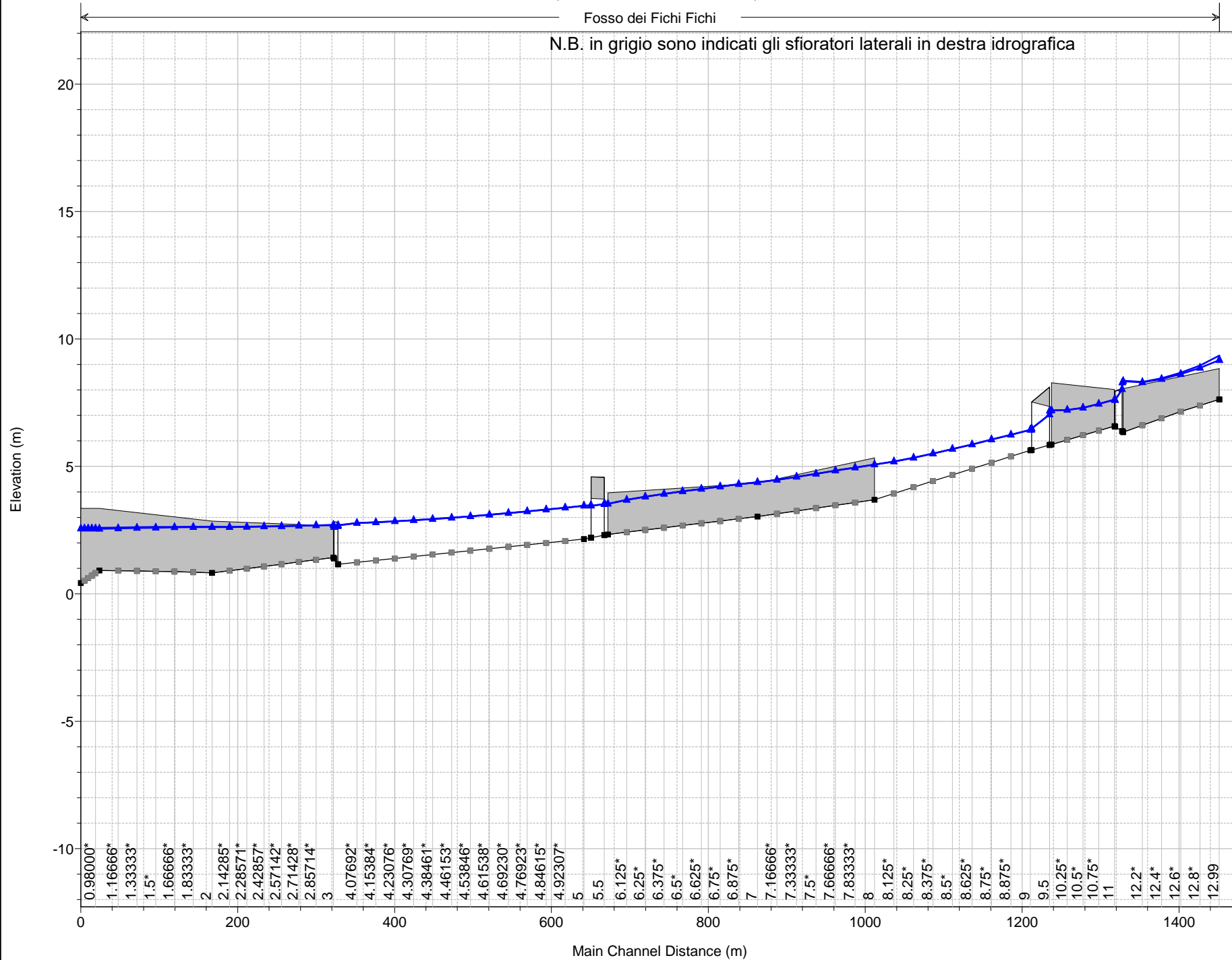

Legend

- WS Max WS - TR200 3H
- WS Max WS - TR303H
- Lat Struct
- Ground

1 cm Horiz. = 65 m 1 cm Vert. = 2 m

0.98000*
 1.16666*
 1.33333*
 1.5*
 1.66666*
 1.83333*
 2
 2.14285*
 2.28571*
 2.42857*
 2.57142*
 2.71428*
 2.85714*
 3
 4.07692*
 4.15384*
 4.23076*
 4.30769*
 4.38461*
 4.46153*
 4.53846*
 4.61538*
 4.69230*
 4.76923*
 4.84615*
 4.92307*
 5
 5.5
 6.125*
 6.25*
 6.375*
 6.5*
 6.625*
 6.75*
 6.875*
 7
 7.16666*
 7.33333*
 7.5*
 7.66666*
 7.83333*
 8
 8.125*
 8.25*
 8.375*
 8.5*
 8.625*
 8.75*
 8.875*
 9
 9.5
 10.25*
 10.5*
 10.75*
 11
 12.2*
 12.4*
 12.6*
 12.8*
 12.99

1) TR200 3H 1/8/19 2) TR303H 1/8/19

Fosso dei Fichi Fichi

N.B. in grigio sono indicati gli sfioratori laterali in sinistra idrografica

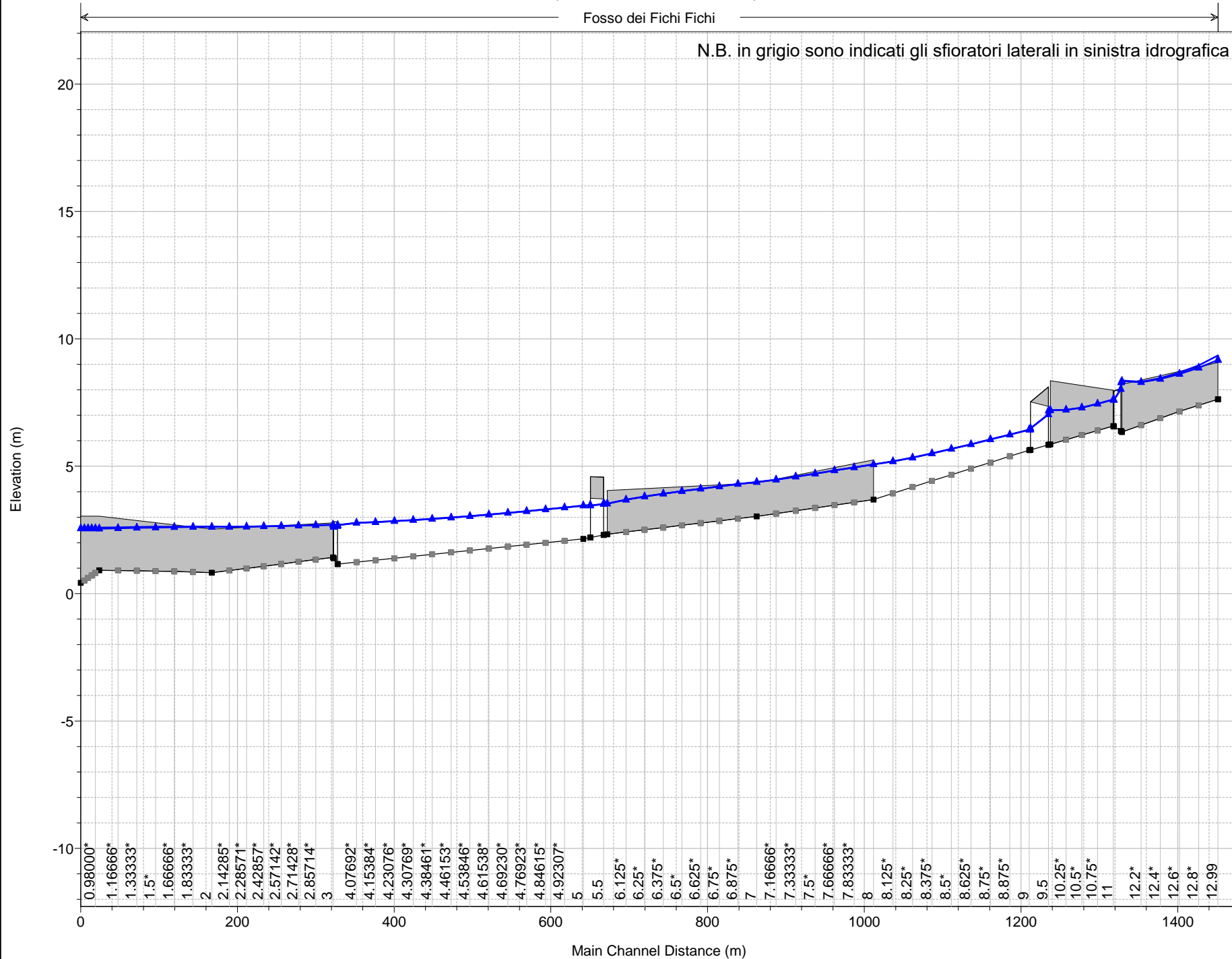

Legend

- WS Max WS - TR200 3H
- WS Max WS - TR303H
- Lat Struct
- Ground

1 cm Horiz. = 65 m 1 cm Vert. = 2 m

1) TR200 3H 1/8/19 2) TR303H 1/8/19
 River = Fosso dei Fichi Reach = Fichi RS = 13

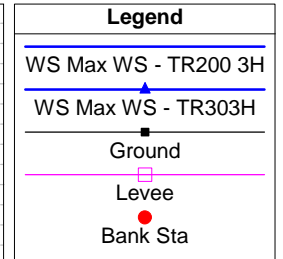
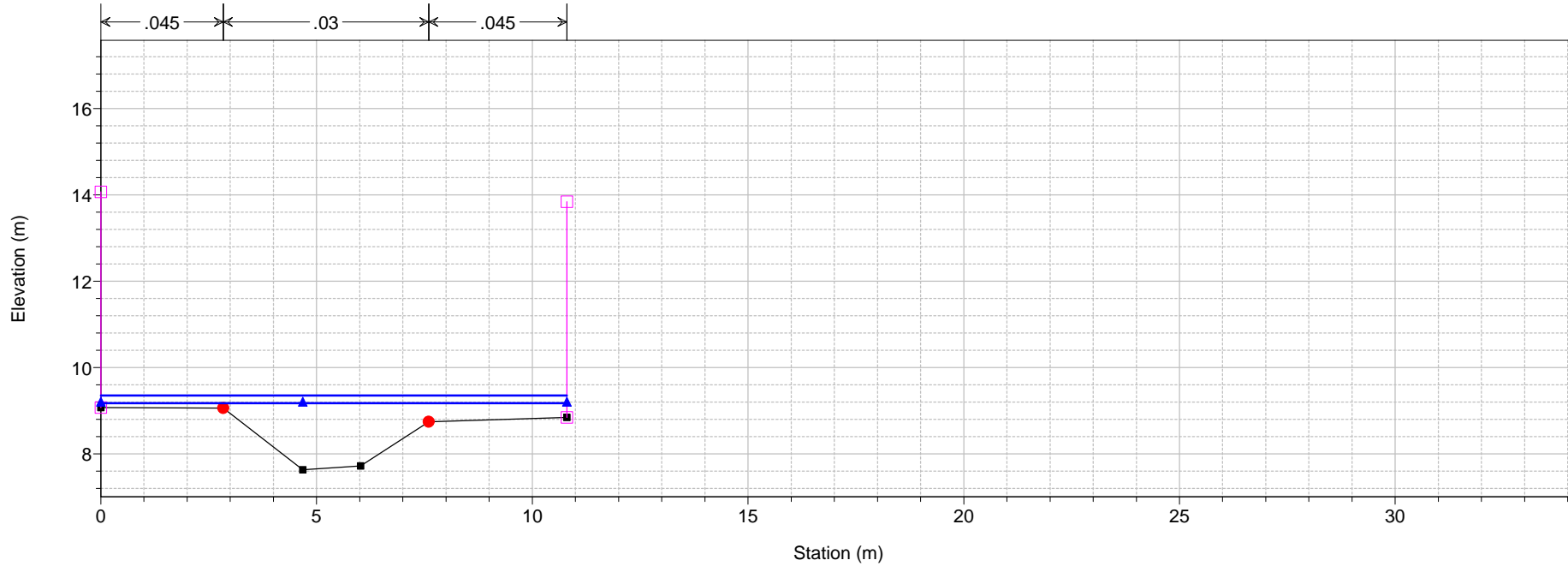

1) TR200 3H 1/8/19 2) TR303H 1/8/19
 River = Fosso dei Fichi Reach = Fichi RS = 12.99

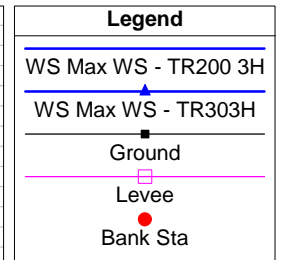
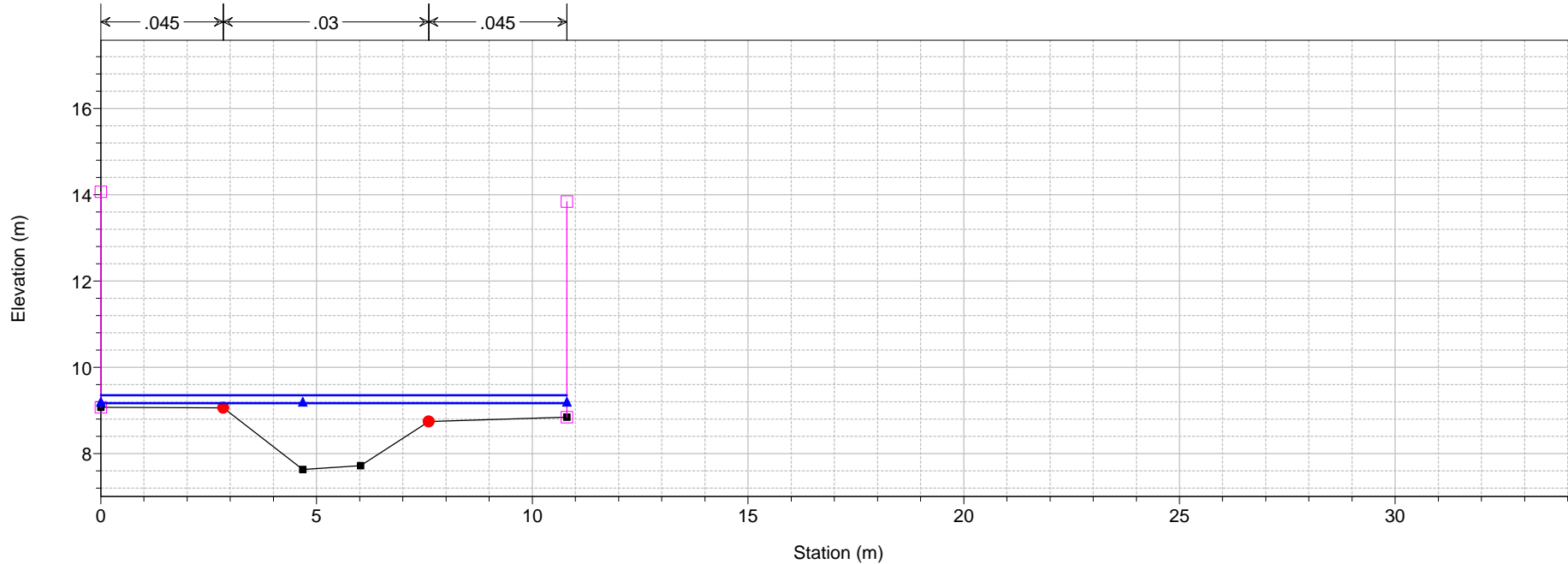

1 cm Horiz. = 1.5 m 1 cm Vert. = 1.5 m

1) TR200 3H 1/8/19 2) TR303H 1/8/19
 River = Fosso dei Fichi Reach = Fichi RS = 12

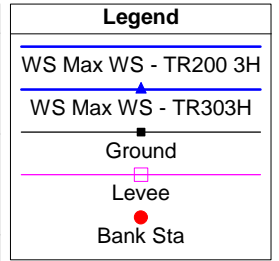
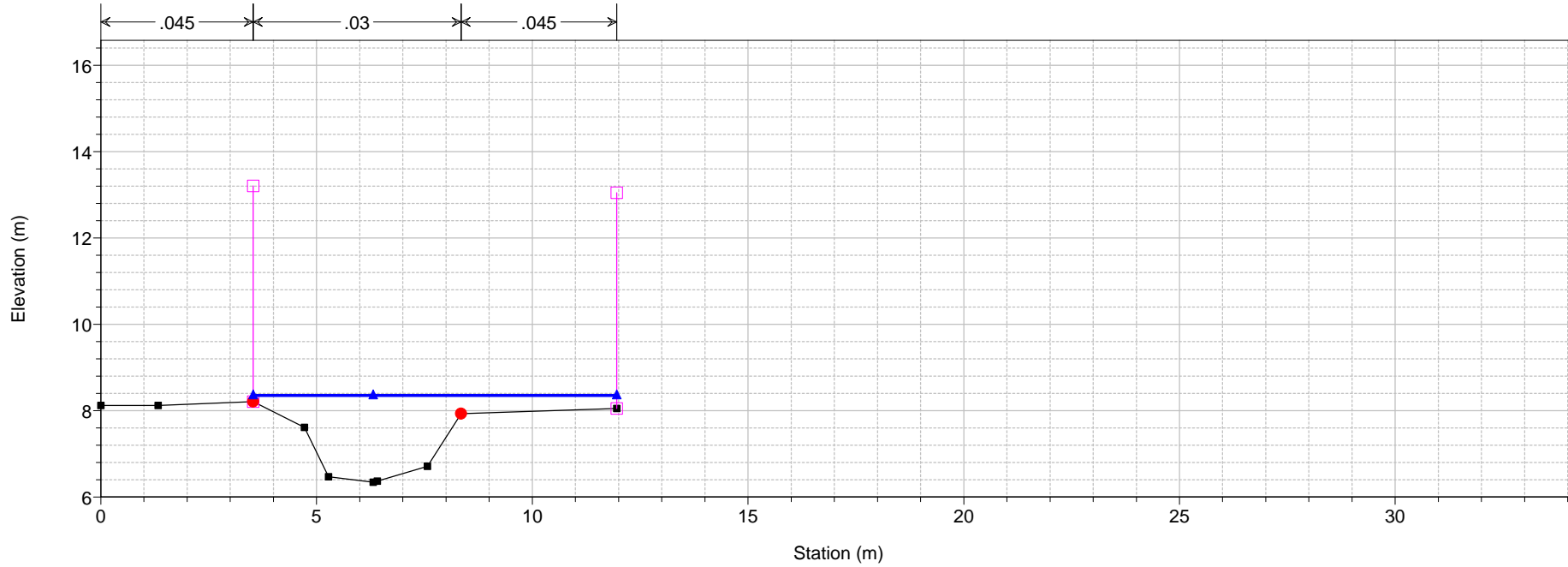

1) TR200 3H 1/8/19 2) TR303H 1/8/19
 River = Fosso dei Fichi Reach = Fichi RS = 11.9

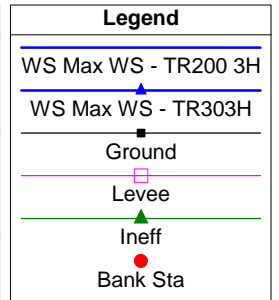
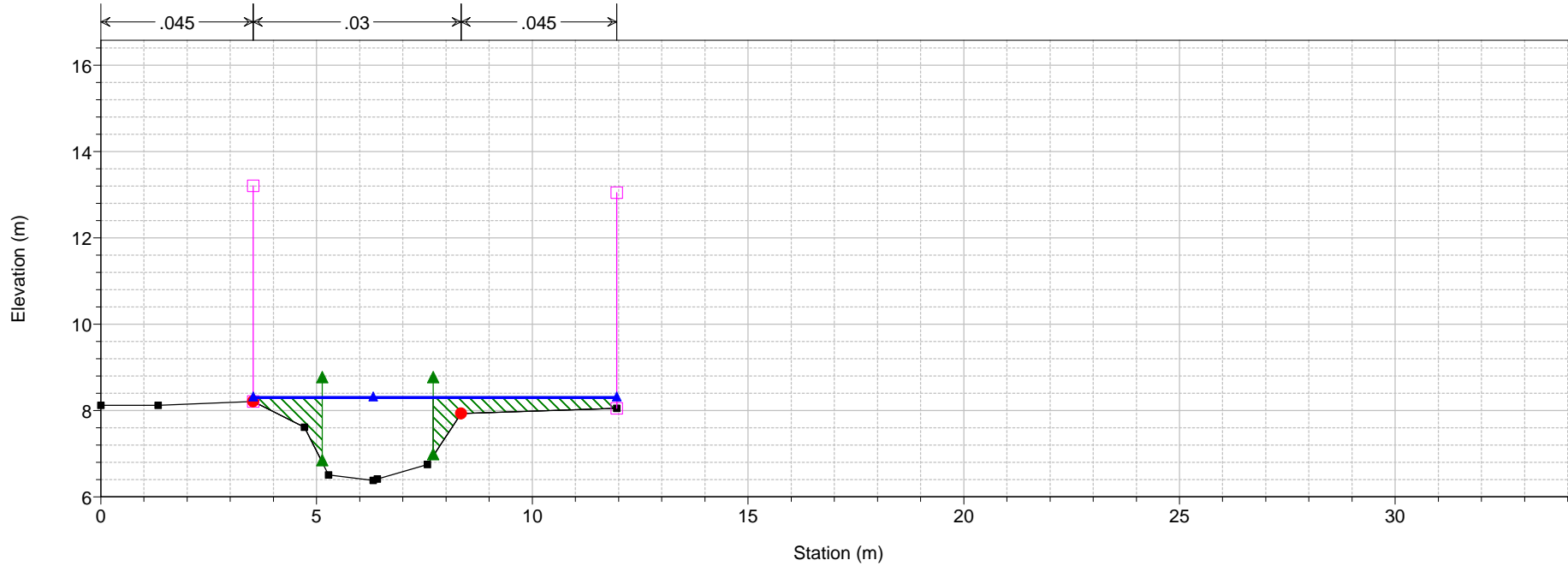

1 cm Horiz. = 1.5 m 1 cm Vert. = 1.5 m

1) TR200 3H 1/8/19 2) TR303H 1/8/19
 River = Fosso dei Fichi Reach = Fichi RS = 11.5 BR

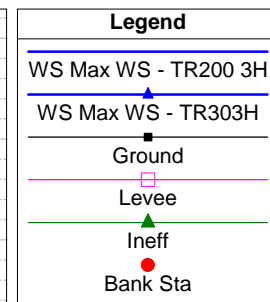
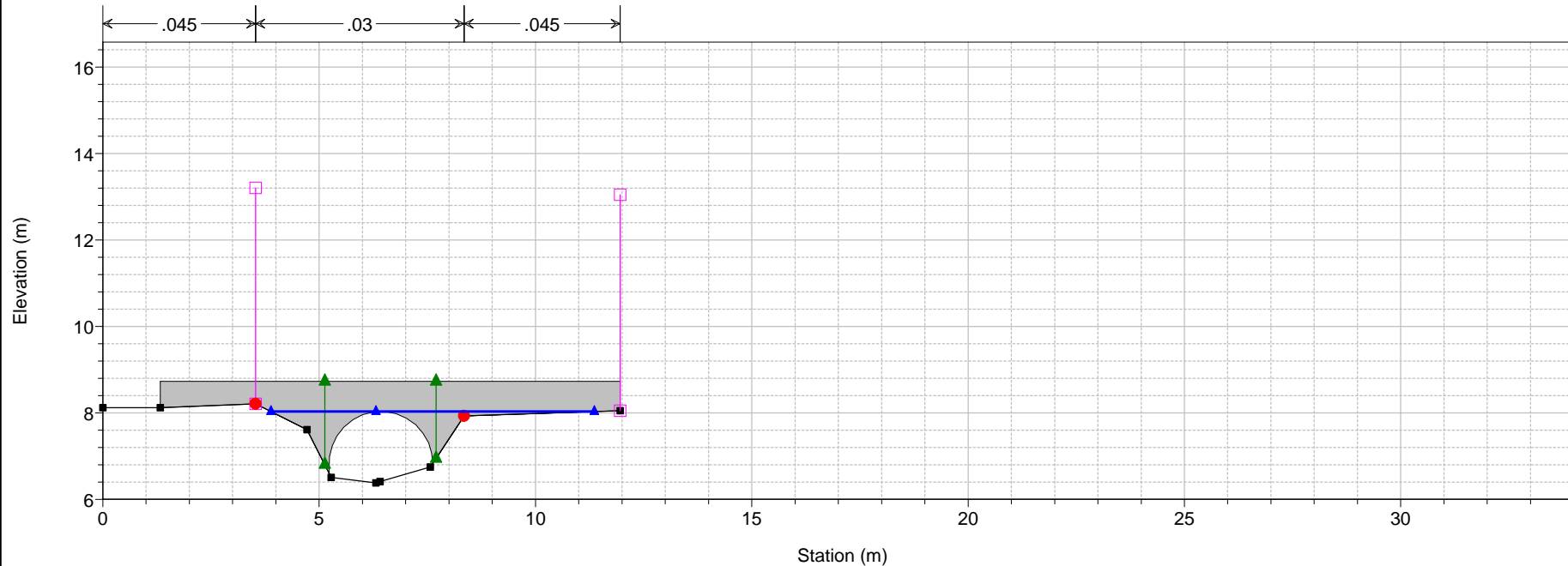

1) TR200 3H 1/8/19 2) TR303H 1/8/19
 River = Fosso dei Fichi Reach = Fichi RS = 11.5 BR

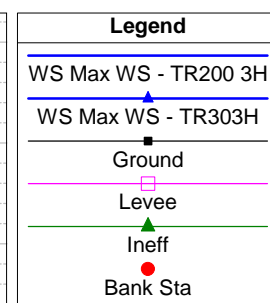
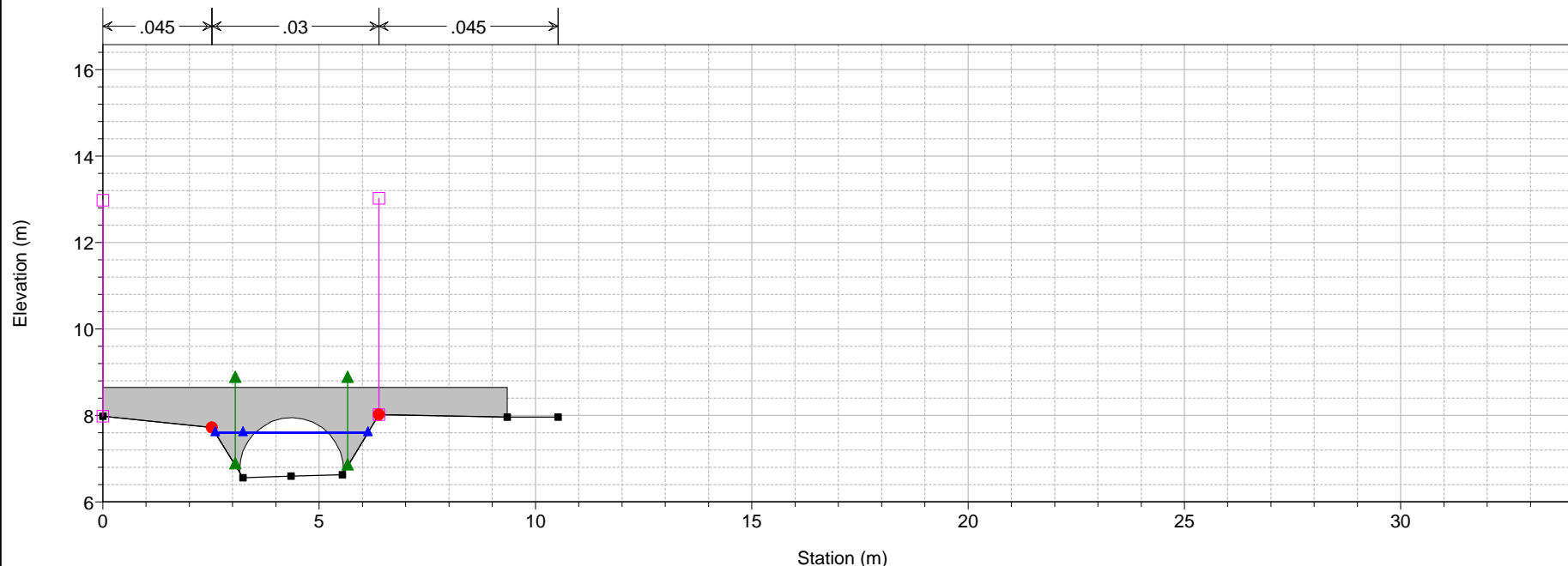

1 cm Horiz. = 1.5 m 1 cm Vert. = 1.5 m

1) TR200 3H 1/8/19 2) TR303H 1/8/19
 River = Fosso dei Fichi Reach = Fichi RS = 11.1

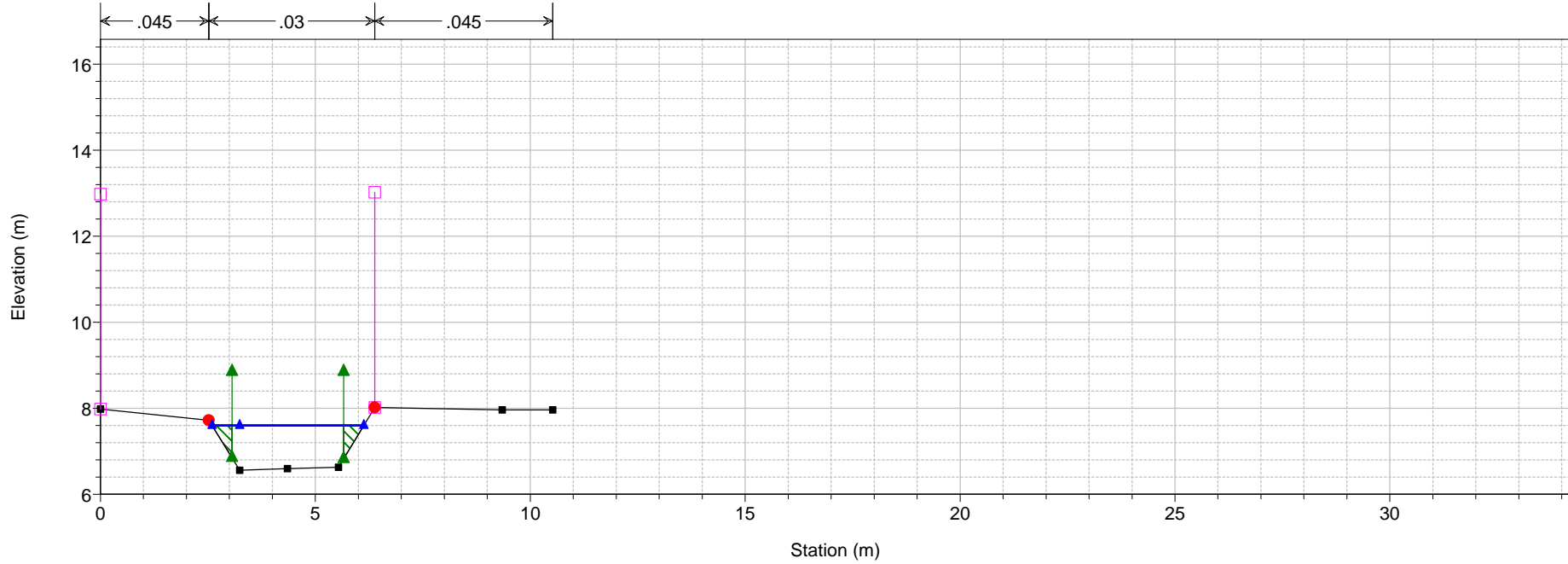

1) TR200 3H 1/8/19 2) TR303H 1/8/19
 River = Fosso dei Fichi Reach = Fichi RS = 11

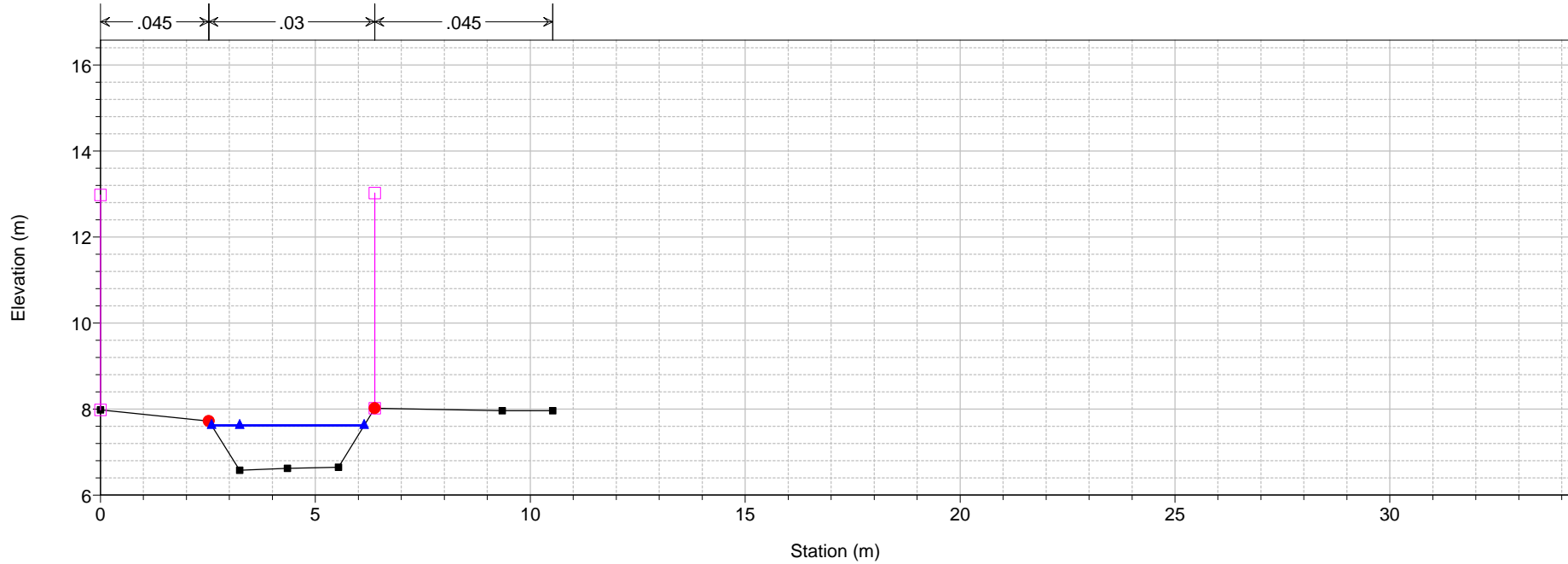

1 cm Horiz. = 1.5 m 1 cm Vert. = 1.5 m

1) TR200 3H 1/8/19 2) TR303H 1/8/19
 River = Fosso dei Fichi Reach = Fichi RS = 10

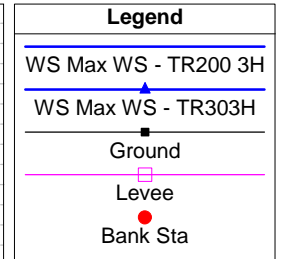
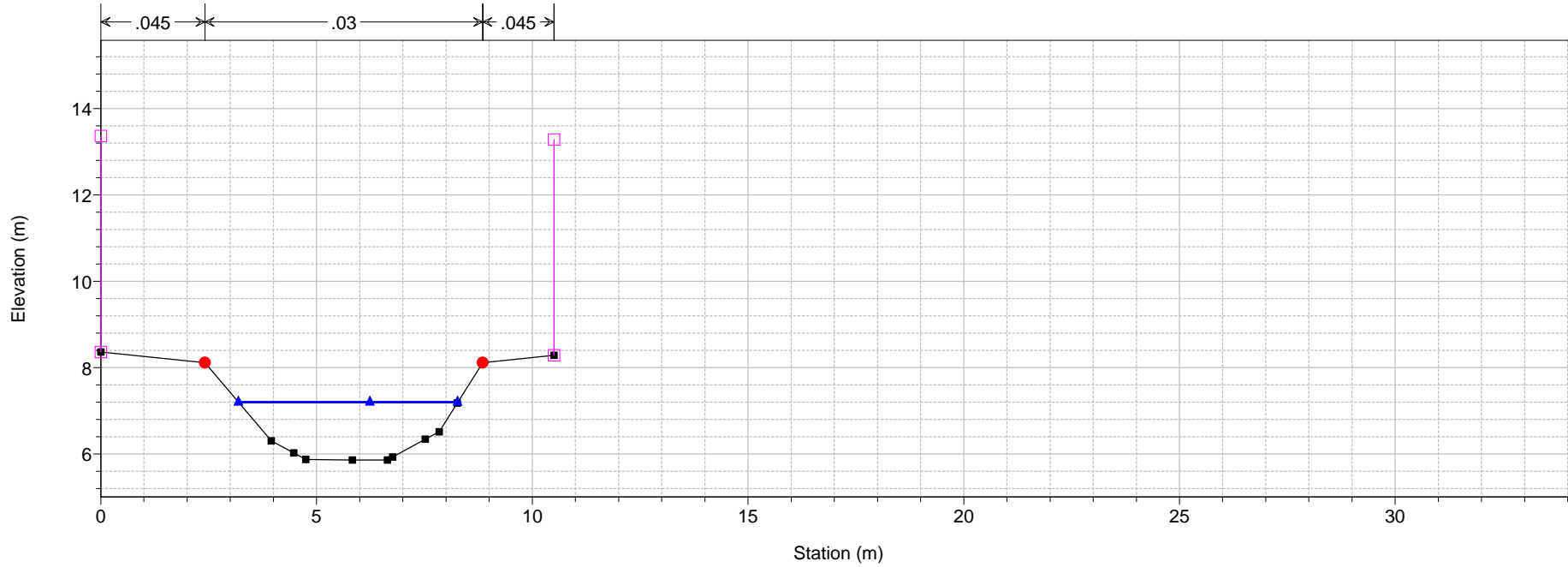

1) TR200 3H 1/8/19 2) TR303H 1/8/19
 River = Fosso dei Fichi Reach = Fichi RS = 9.9

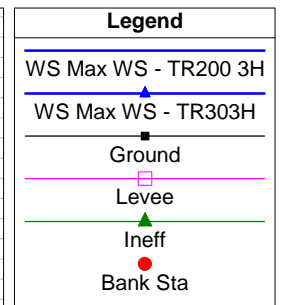
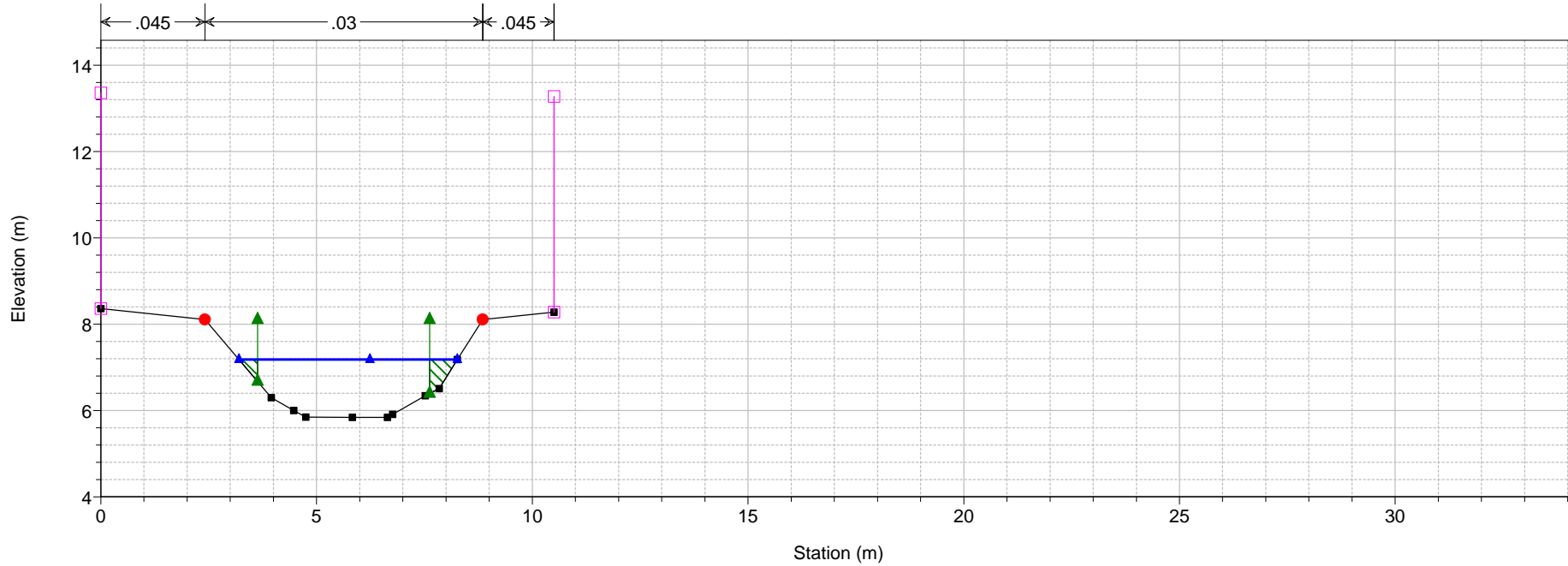

1 cm Horiz. = 1.5 m 1 cm Vert. = 1.5 m

1) TR200 3H 1/8/19 2) TR303H 1/8/19
 River = Fosso dei Fichi Reach = Fichi RS = 9.5 BR

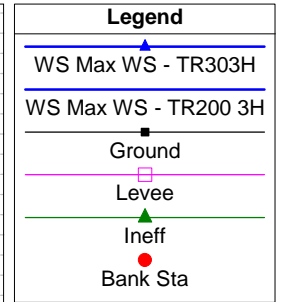
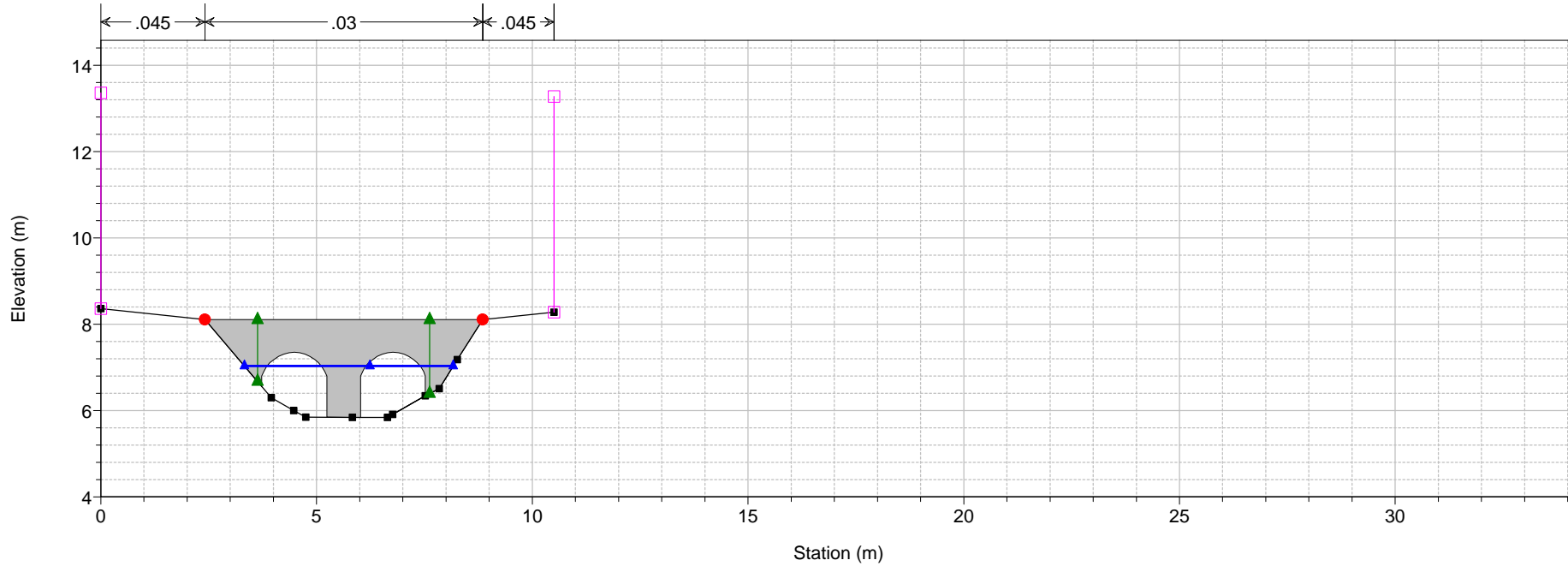

1) TR200 3H 1/8/19 2) TR303H 1/8/19
 River = Fosso dei Fichi Reach = Fichi RS = 9.5 BR

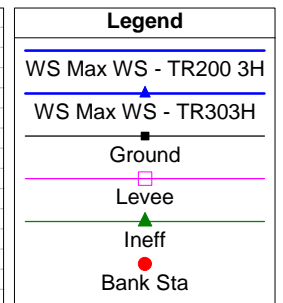
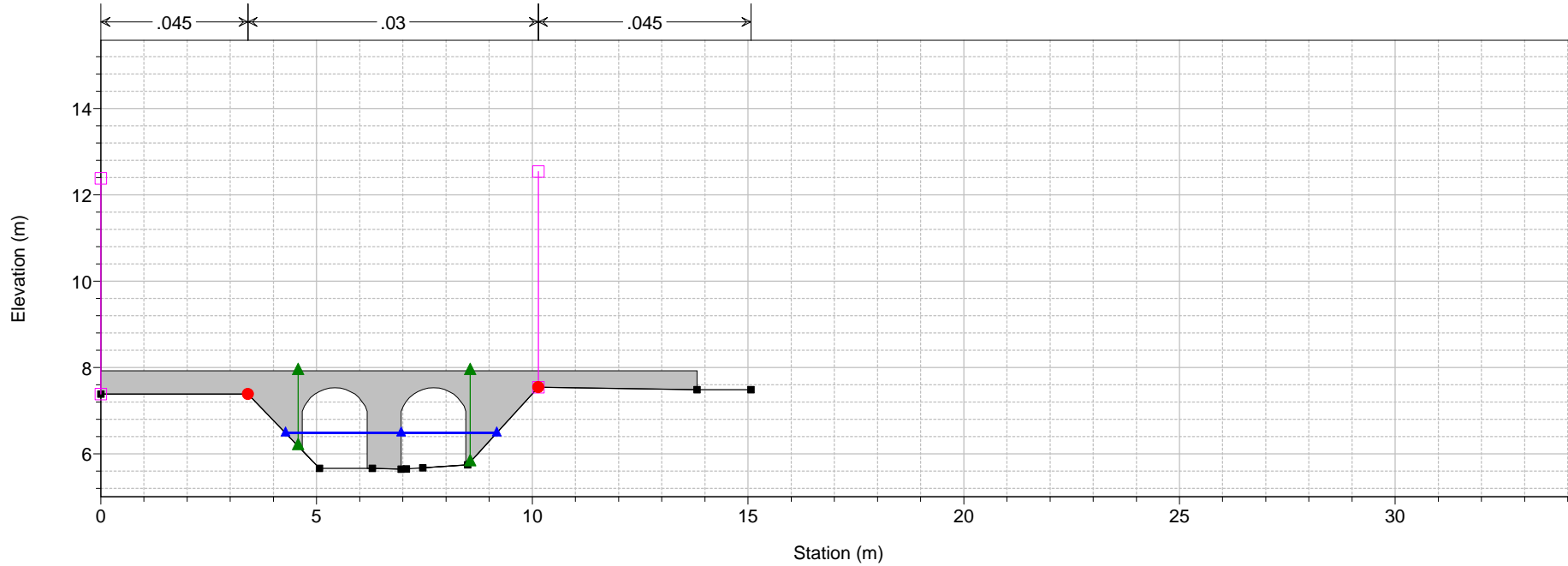

1 cm Horiz. = 1.5 m 1 cm Vert. = 1.5 m

1) TR200 3H 1/8/19 2) TR303H 1/8/19
 River = Fosso dei Fichi Reach = Fichi RS = 9.1

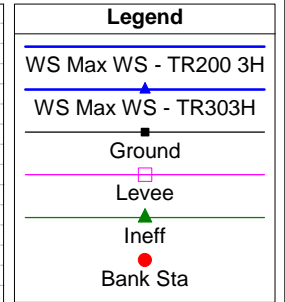
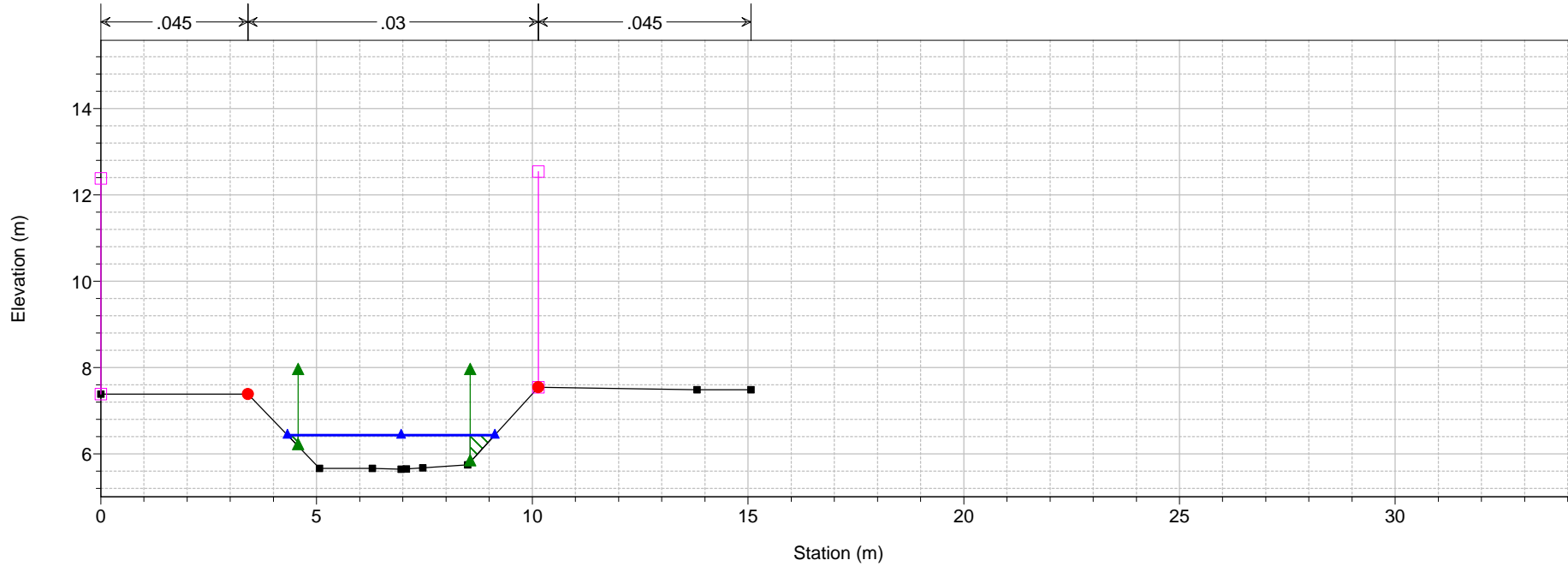

1) TR200 3H 1/8/19 2) TR303H 1/8/19
 River = Fosso dei Fichi Reach = Fichi RS = 9

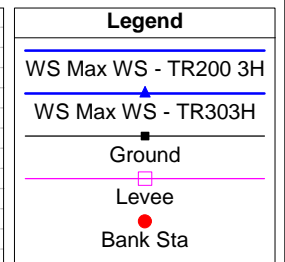
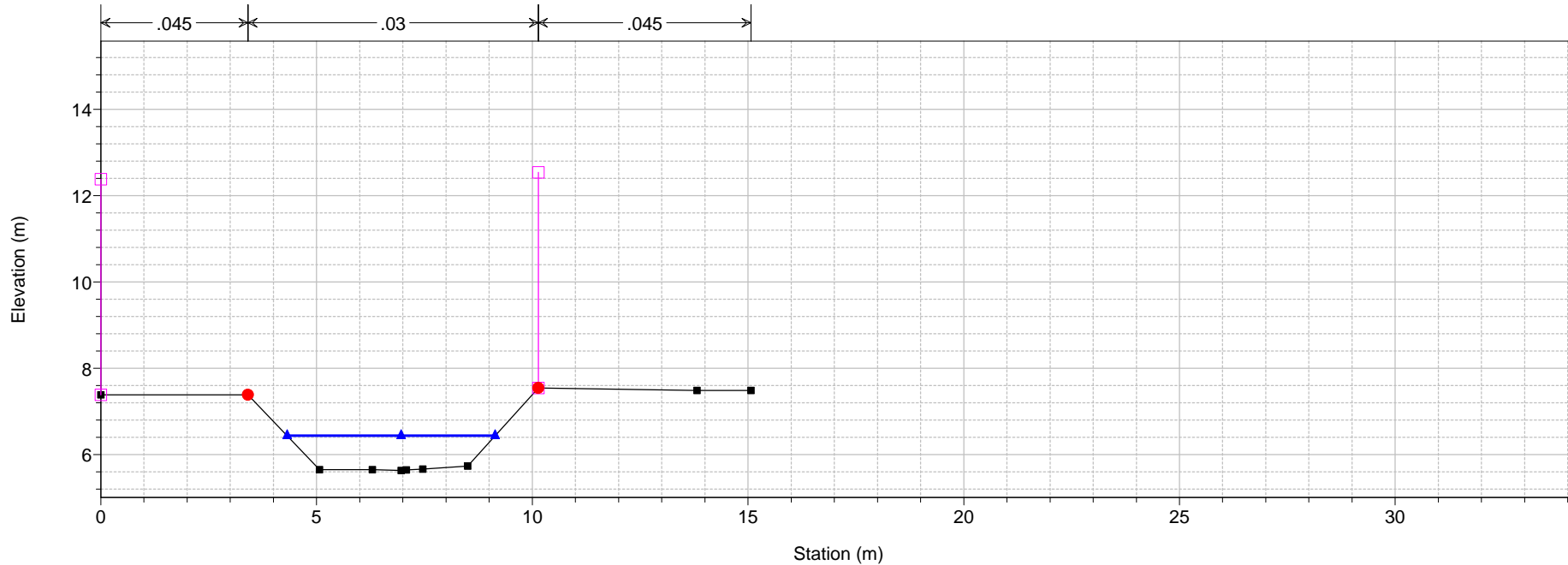

1 cm Horiz. = 1.5 m 1 cm Vert. = 1.5 m

1) TR200 3H 1/8/19 2) TR303H 1/8/19
 River = Fosso dei Fichi Reach = Fichi RS = 8

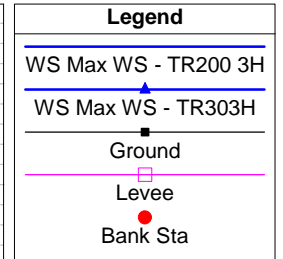
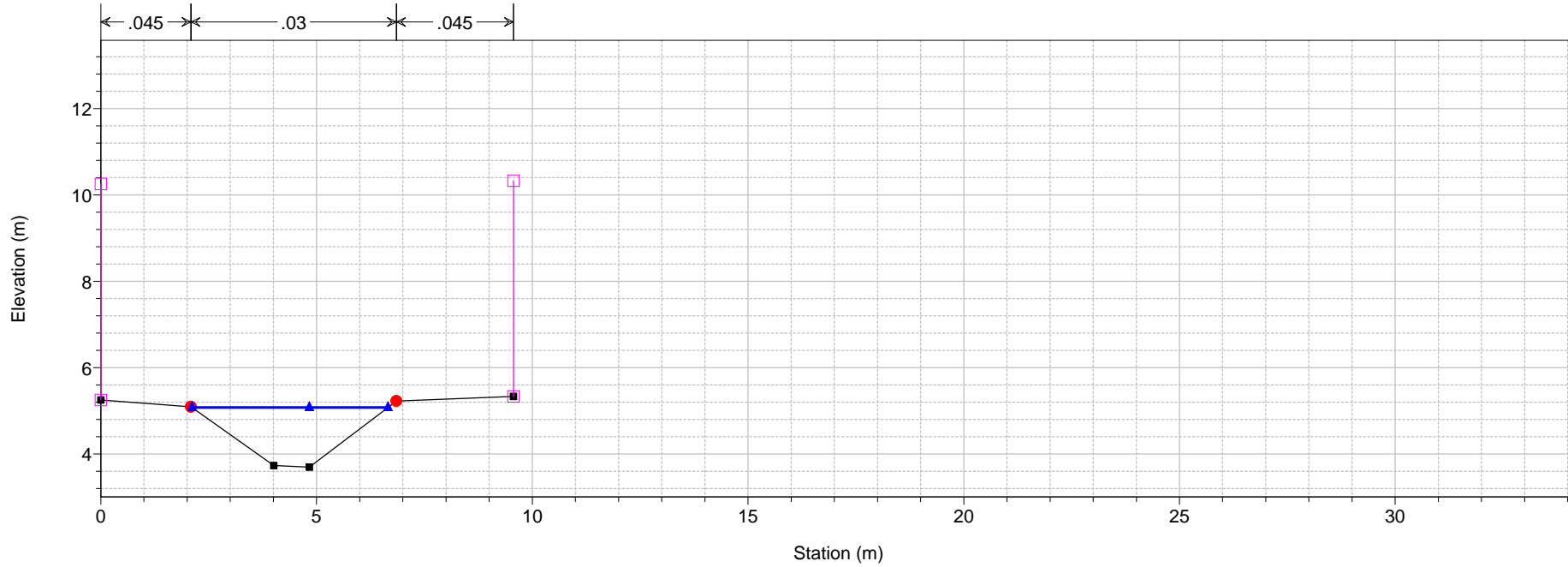

1) TR200 3H 1/8/19 2) TR303H 1/8/19
 River = Fosso dei Fichi Reach = Fichi RS = 7

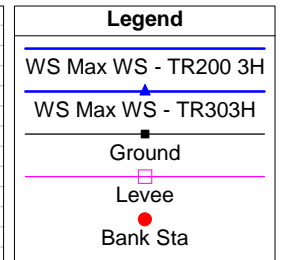
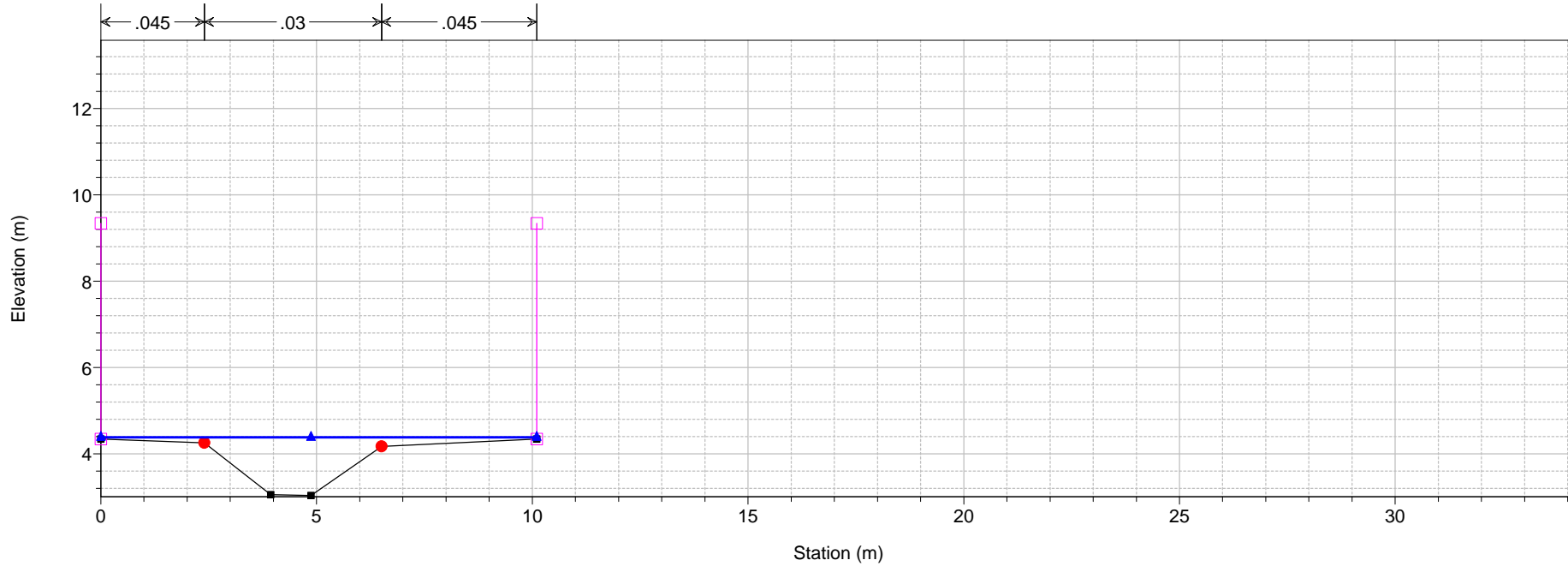

1 cm Horiz. = 1.5 m 1 cm Vert. = 1.5 m

1) TR200 3H 1/8/19 2) TR303H 1/8/19
 River = Fosso dei Fichi Reach = Fichi RS = 6

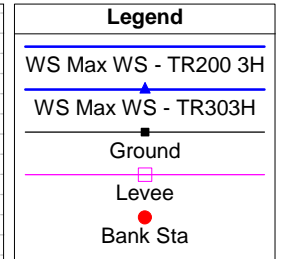
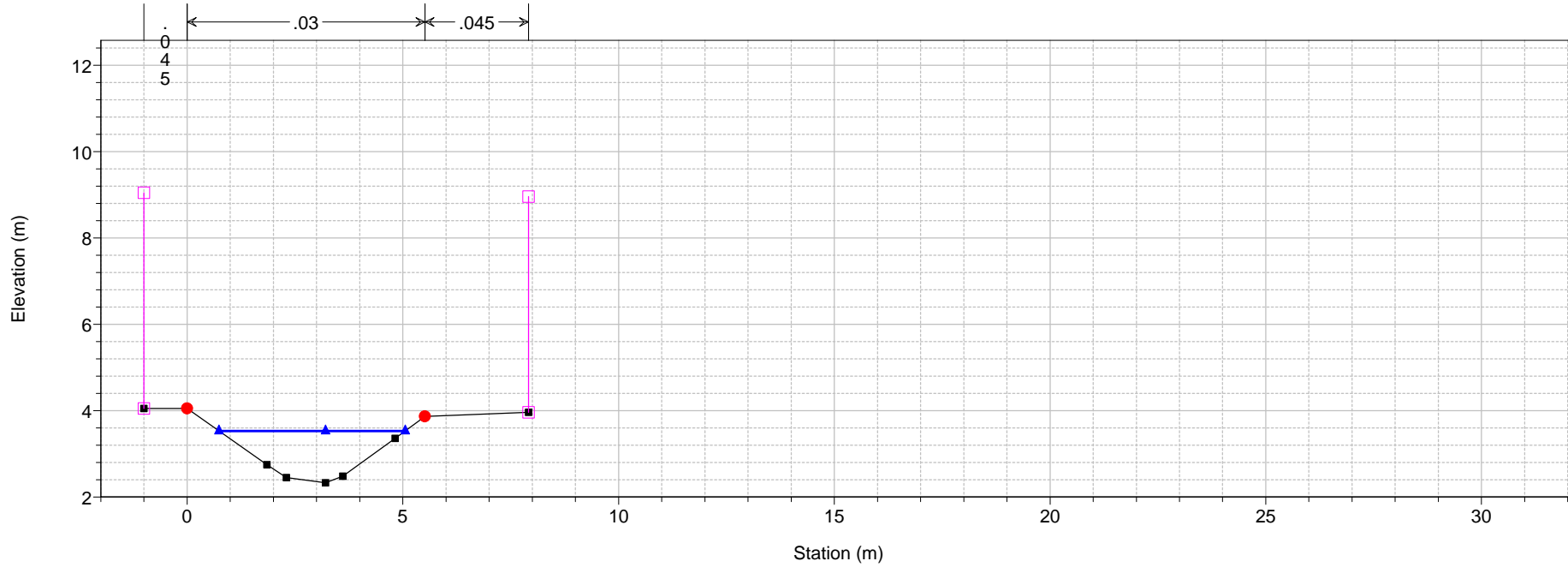

1) TR200 3H 1/8/19 2) TR303H 1/8/19
 River = Fosso dei Fichi Reach = Fichi RS = 5.9

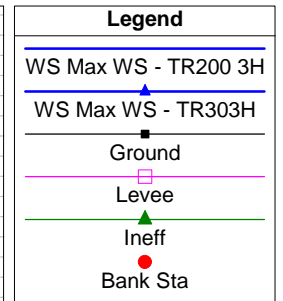
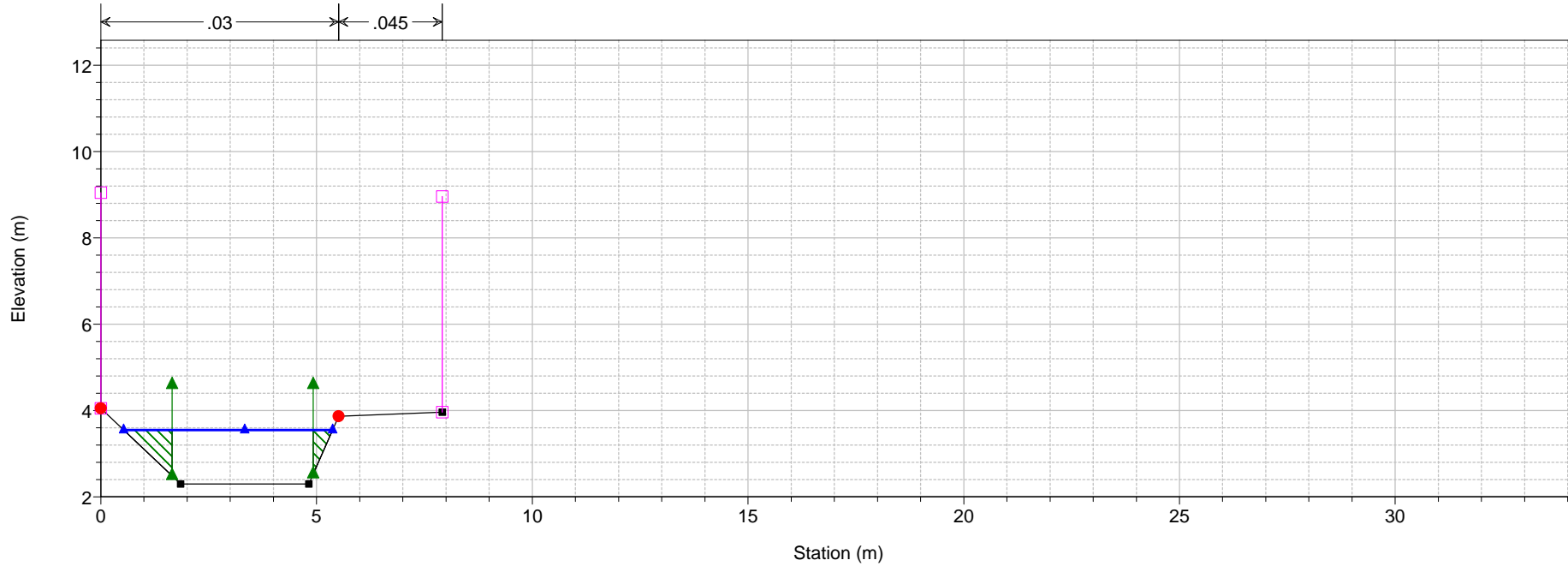

1 cm Horiz. = 1.5 m 1 cm Vert. = 1.5 m

1) TR200 3H 1/8/19 2) TR303H 1/8/19
 River = Fosso dei Fichi Reach = Fichi RS = 5.5 BR

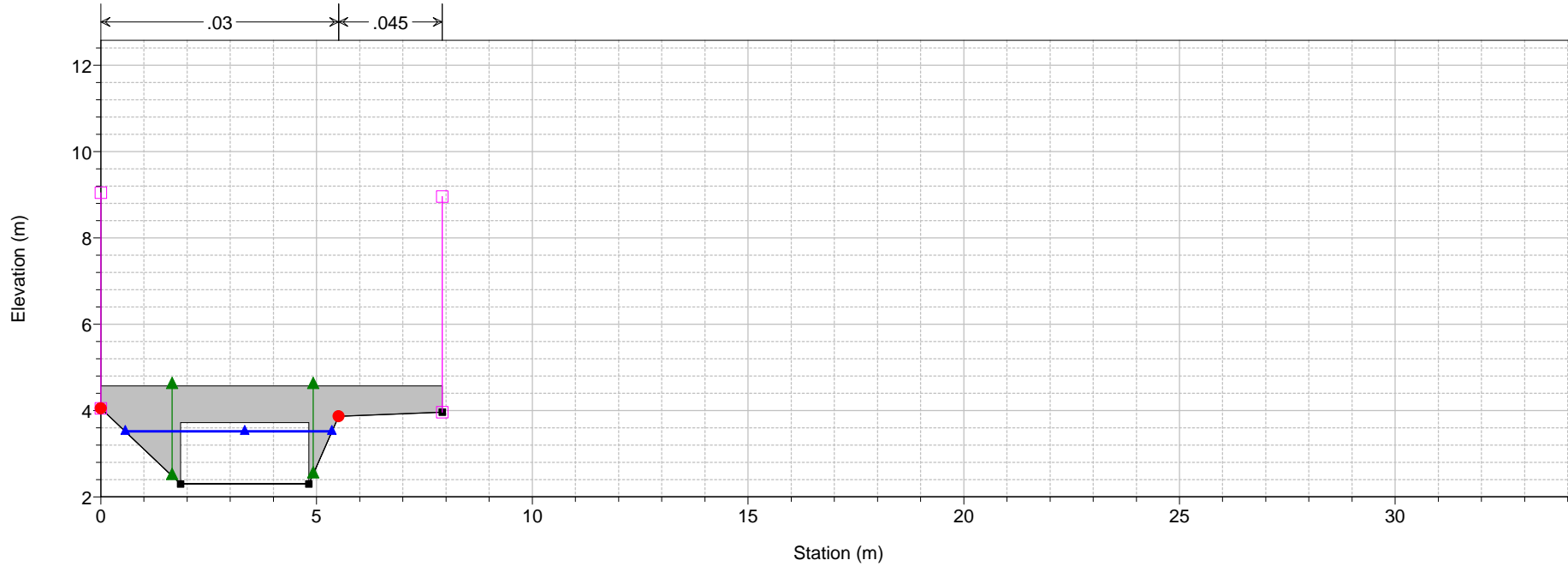

1) TR200 3H 1/8/19 2) TR303H 1/8/19
 River = Fosso dei Fichi Reach = Fichi RS = 5.5 BR

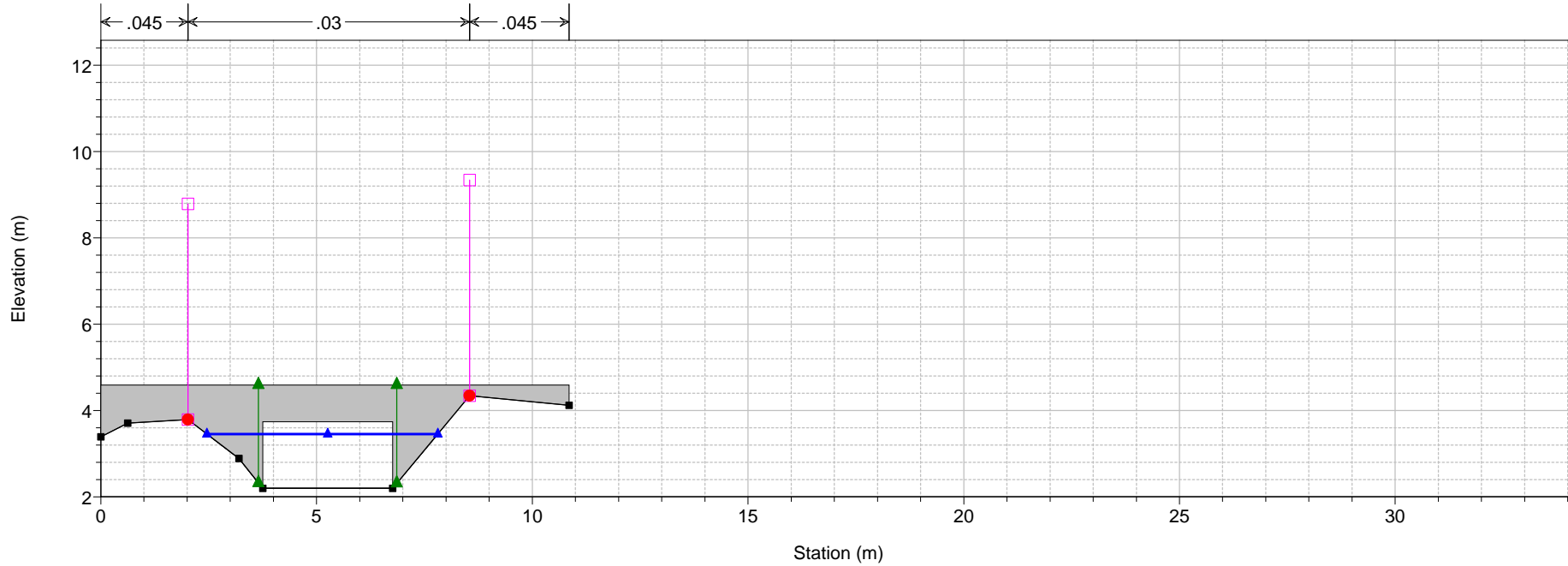

1 cm Horiz. = 1.5 m 1 cm Vert. = 1.5 m

1) TR200 3H 1/8/19 2) TR303H 1/8/19
 River = Fosso dei Fichi Reach = Fichi RS = 5.1

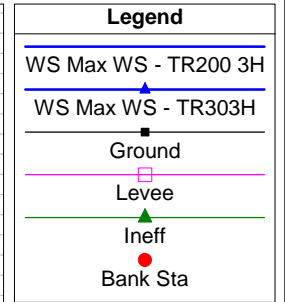
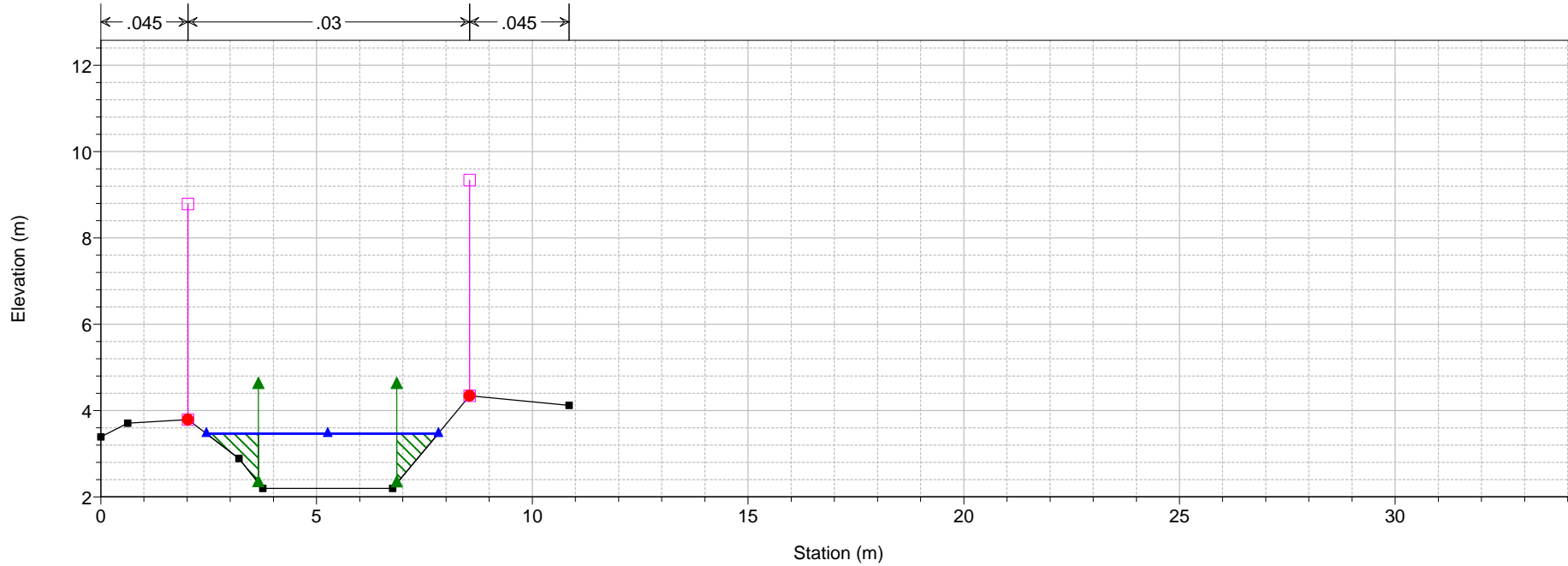

1) TR200 3H 1/8/19 2) TR303H 1/8/19
 River = Fosso dei Fichi Reach = Fichi RS = 5

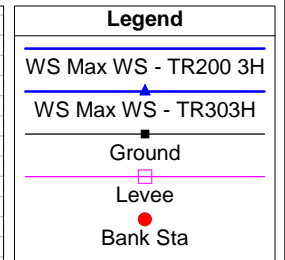
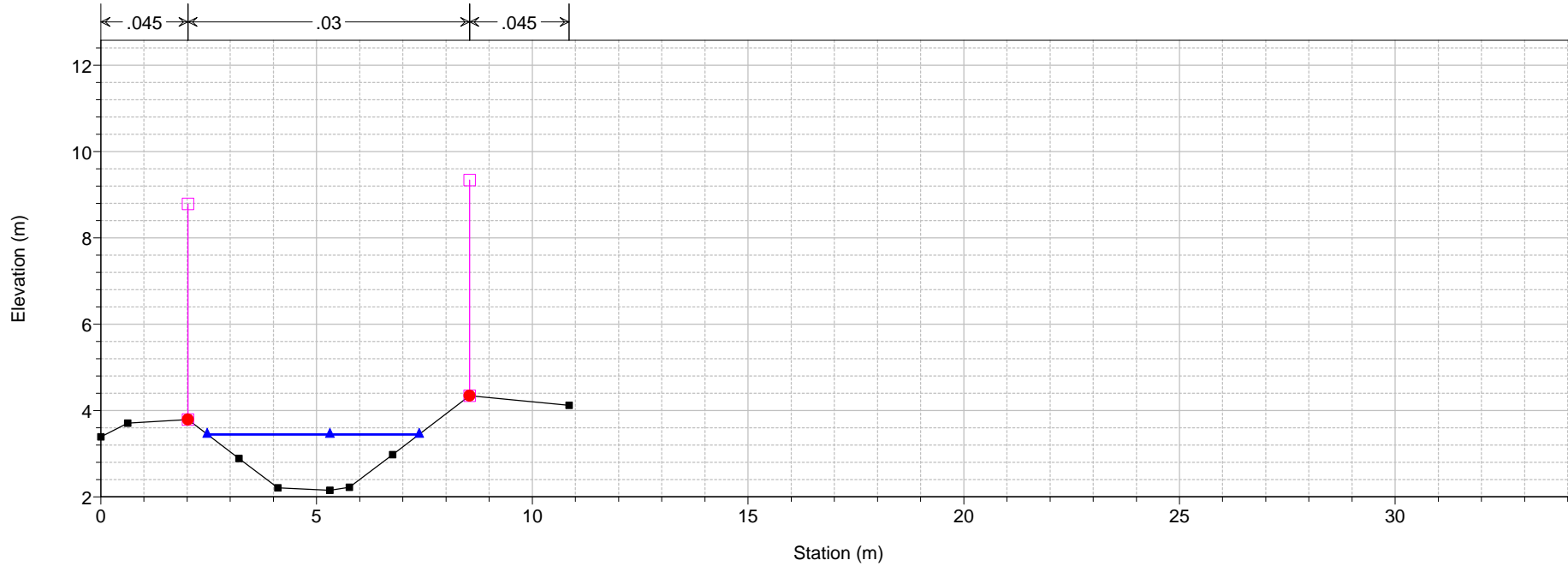

1 cm Horiz. = 1.5 m 1 cm Vert. = 1.5 m

1) TR200 3H 1/8/19 2) TR303H 1/8/19
 River = Fosso dei Fichi Reach = Fichi RS = 4

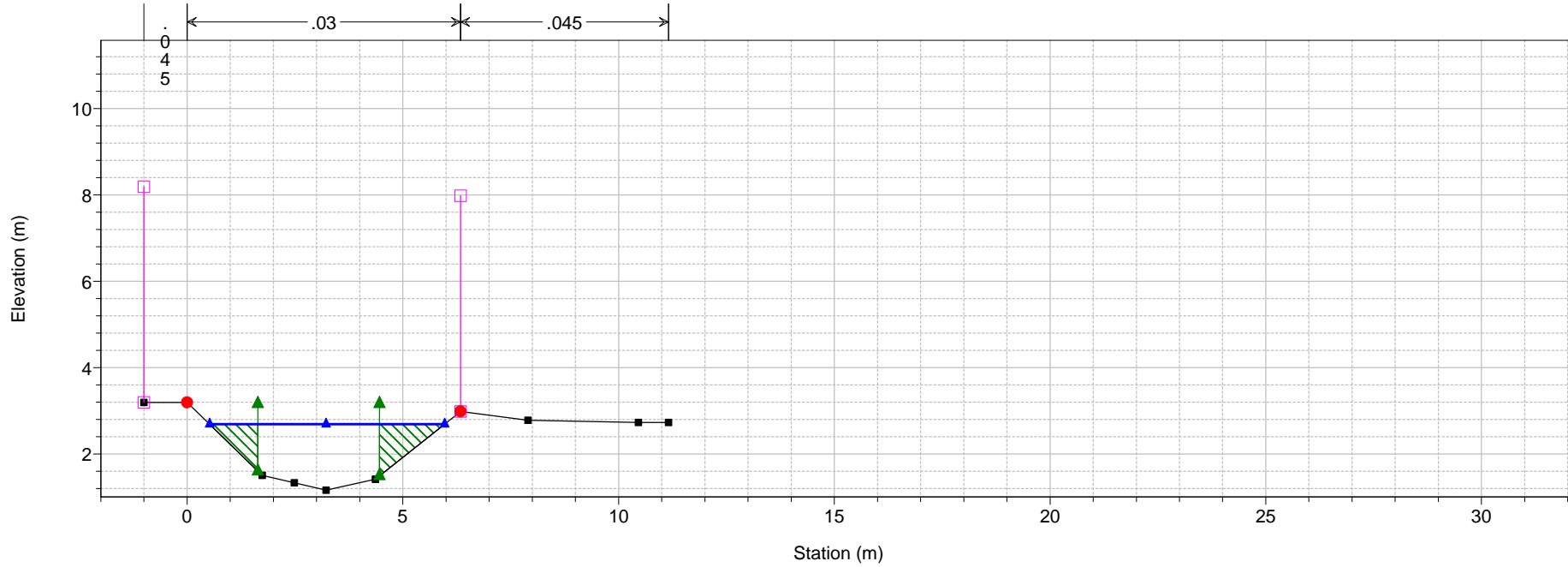

1) TR200 3H 1/8/19 2) TR303H 1/8/19
 River = Fosso dei Fichi Reach = Fichi RS = 3.5 BR

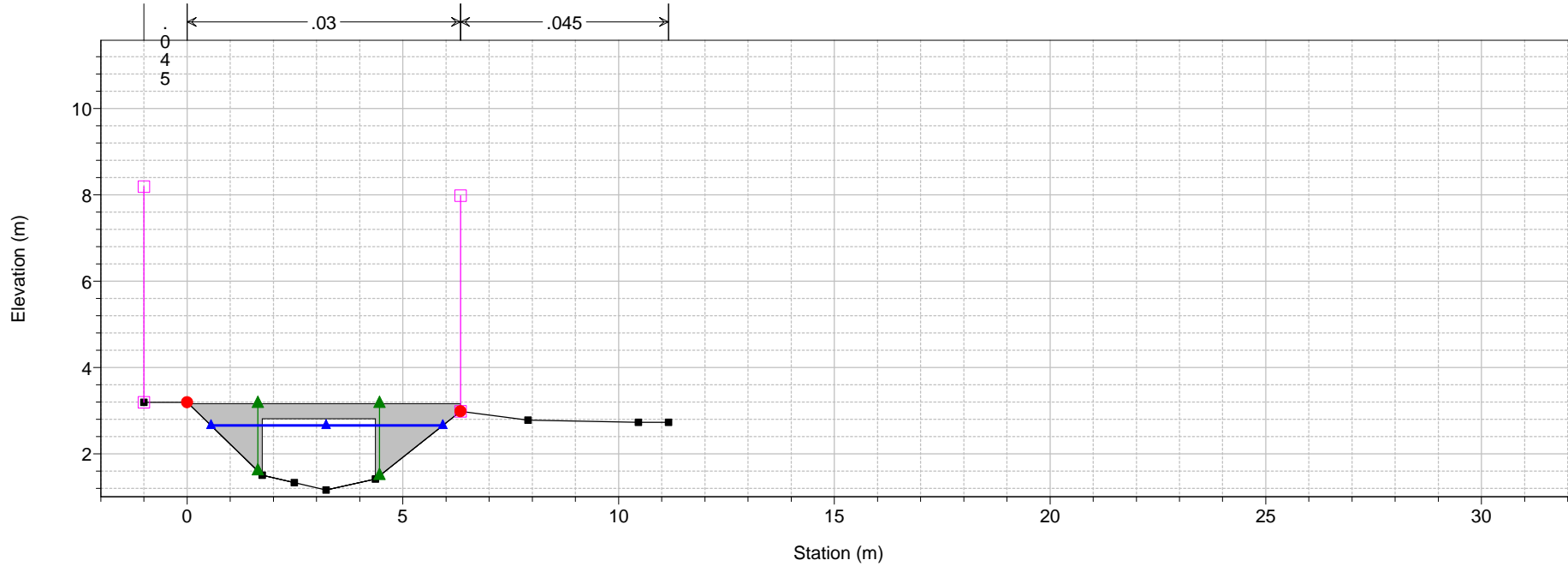

1 cm Horiz. = 1.5 m 1 cm Vert. = 1.5 m

1) TR200 3H 1/8/19 2) TR303H 1/8/19
 River = Fosso dei Fichi Reach = Fichi RS = 3.5 BR

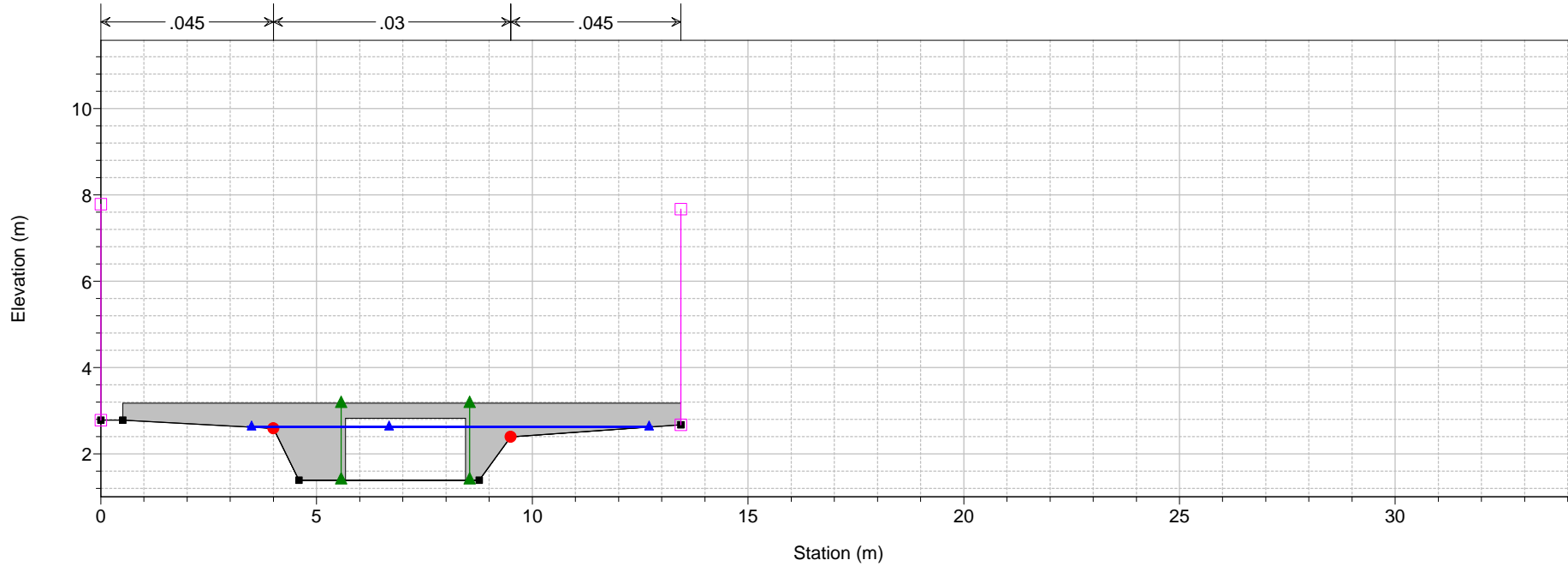

1) TR200 3H 1/8/19 2) TR303H 1/8/19
 River = Fosso dei Fichi Reach = Fichi RS = 3.1

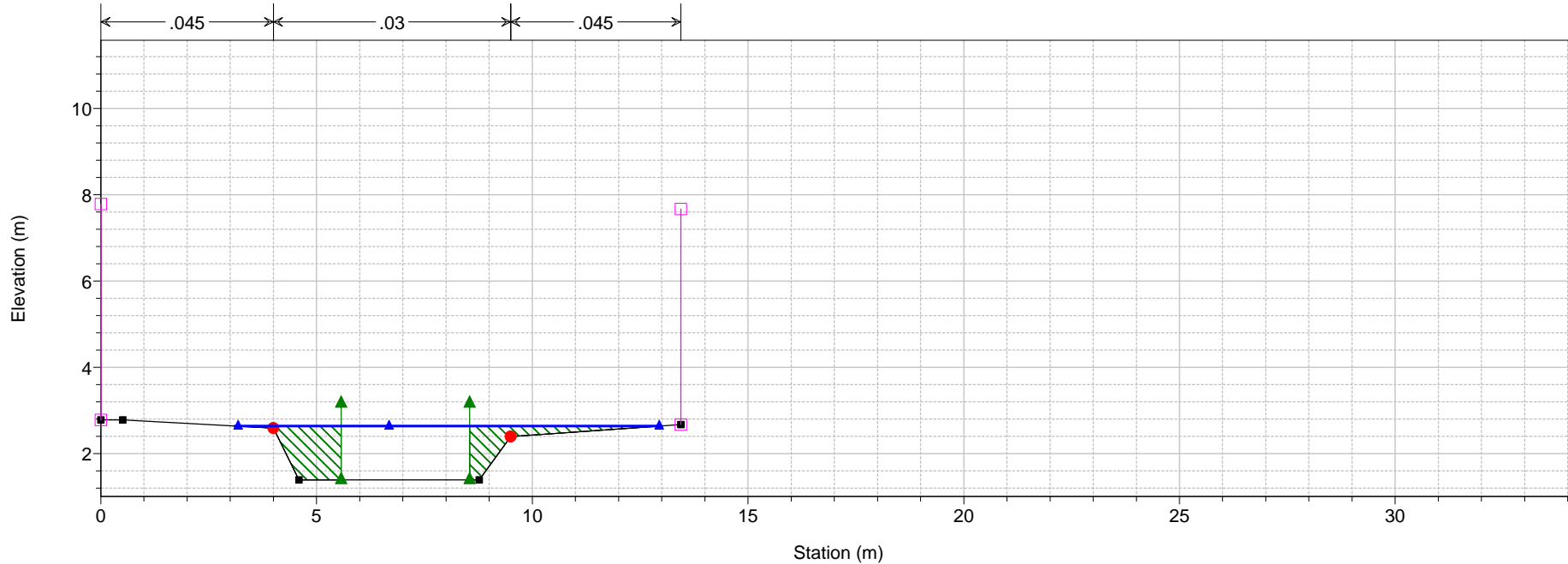

1 cm Horiz. = 1.5 m 1 cm Vert. = 1.5 m

1) TR200 3H 1/8/19 2) TR303H 1/8/19

River = Fosso dei Fichi Reach = Fichi RS = 3

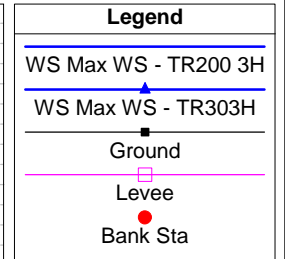
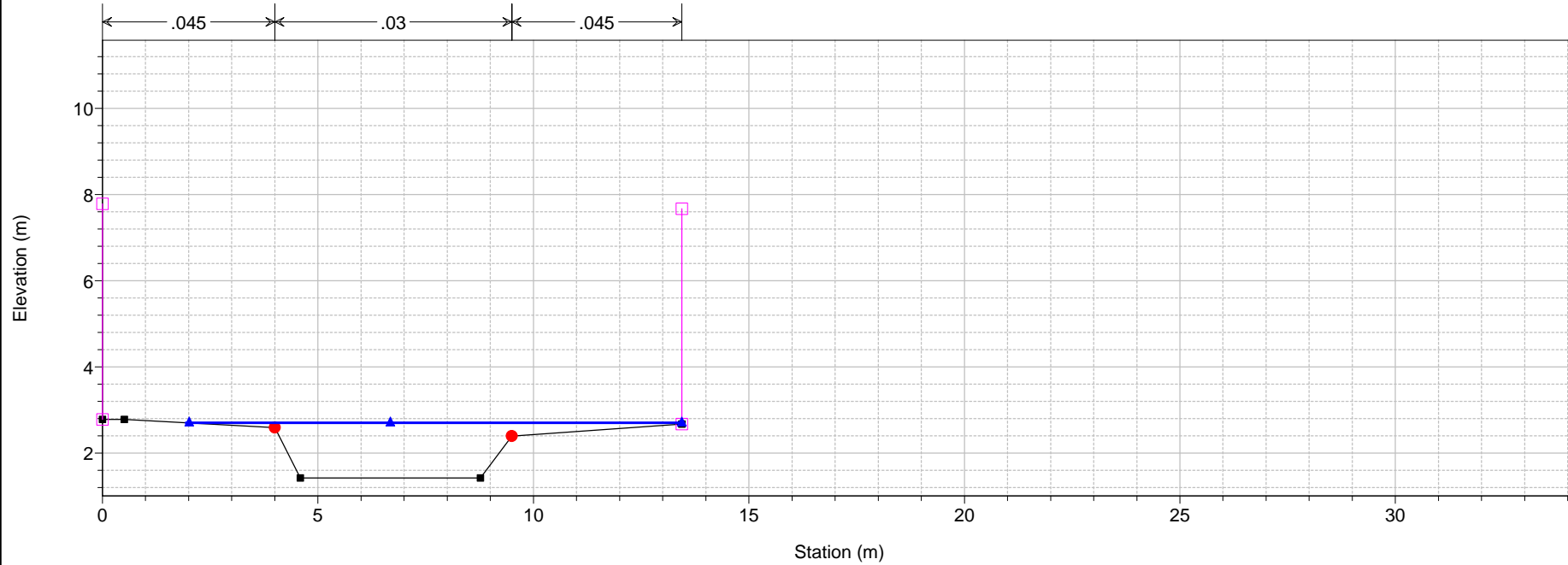

1) TR200 3H 1/8/19 2) TR303H 1/8/19

River = Fosso dei Fichi Reach = Fichi RS = 2

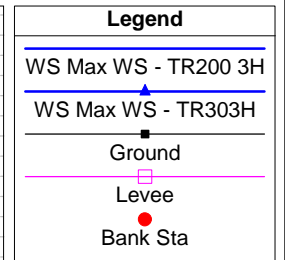
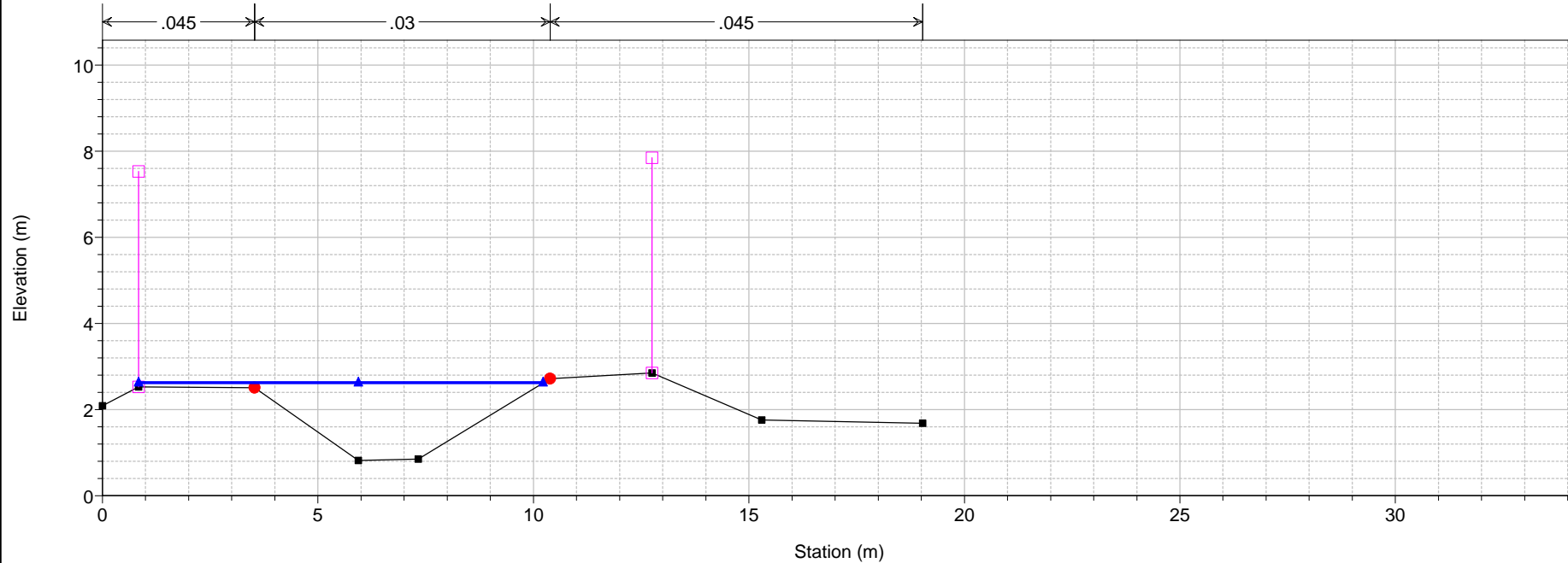

1 cm Horiz. = 1.5 m 1 cm Vert. = 1.5 m

1) TR200 3H 1/8/19 2) TR303H 1/8/19

River = Fosso dei Fichi Reach = Fichi RS = 1

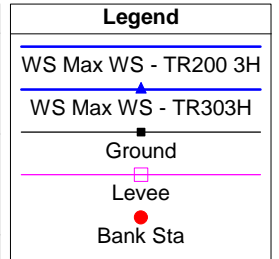
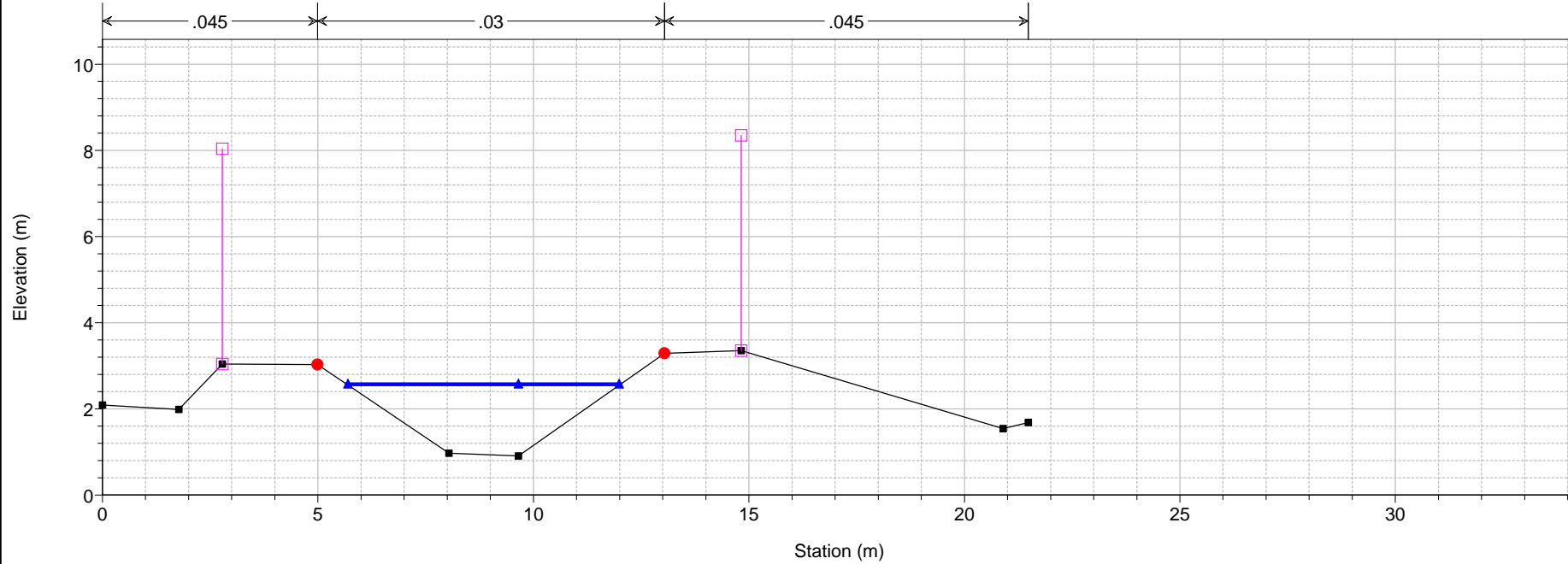

1) TR200 3H 1/8/19 2) TR303H 1/8/19

River = Fosso dei Fichi Reach = Fichi RS = 0.9

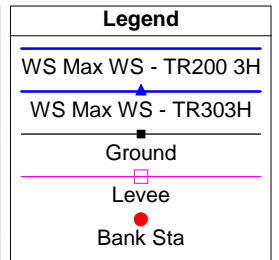
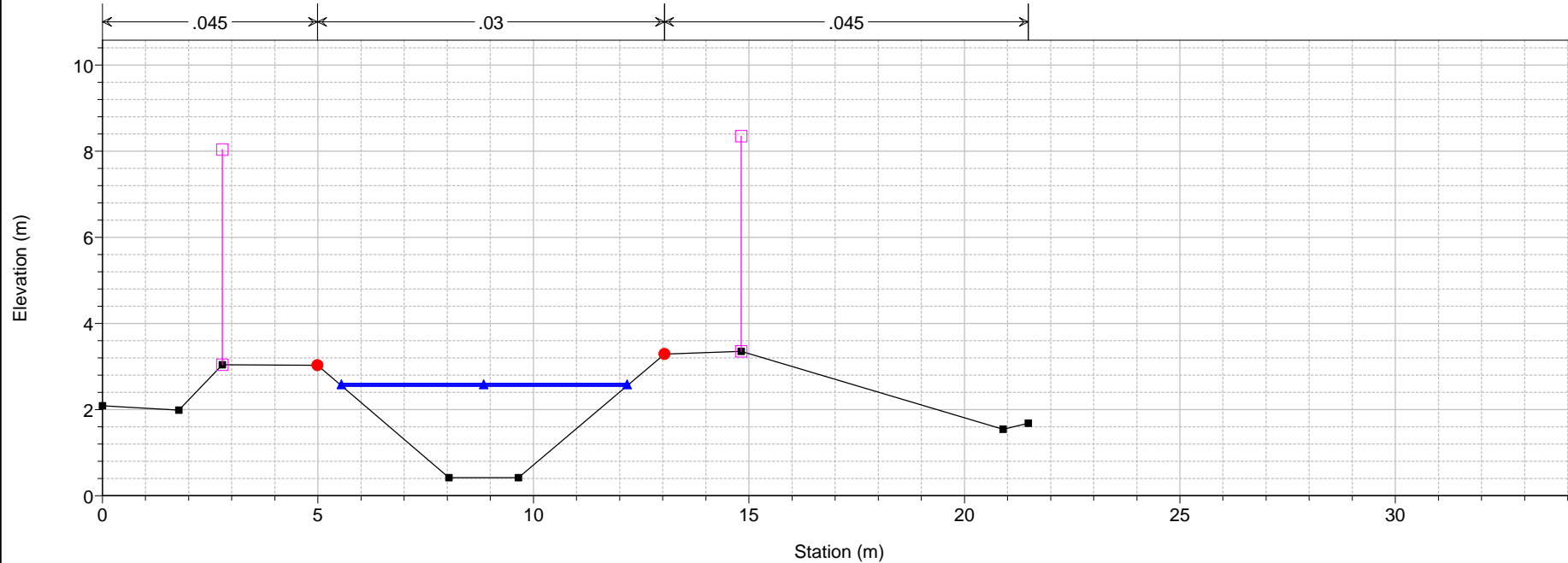

1 cm Horiz. = 1.5 m 1 cm Vert. = 1.5 m

Reach	River Sta	Profile	Plan	Q Total (m3/s)	Min Ch El (m)	W.S. Elev (m)	Crit W.S. (m)	E.G. Elev (m)	E.G. Slope (m/m)	Vel Chnl (m/s)	Flow Area (m2)	Top Width (m)	Froude # Chl
Fichi	13	Max WS	TR200 3H	32.24	7.63	9.35	9.64	10.37	0.018926	4.75	8.46	10.80	1.37
Fichi	13	Max WS	TR303H	20.29	7.63	9.17	9.34	9.82	0.014177	3.70	6.52	10.80	1.15
Fichi	12.99	Max WS	TR200 3H	32.24	7.63	9.35	9.64	10.37	0.019040	4.76	8.44	10.80	1.37
Fichi	12.99	Max WS	TR303H	20.29	7.63	9.17	9.34	9.82	0.014260	3.71	6.50	10.80	1.16
Fichi	12.98			Lat Struct									
Fichi	12.97			Lat Struct									
Fichi	12	Max WS	TR200 3H	6.49	6.34	8.36	7.37	8.40	0.000828	0.95	7.75	8.43	0.26
Fichi	12	Max WS	TR303H	6.47	6.34	8.34	7.36	8.38	0.000873	0.96	7.58	8.43	0.27
Fichi	11.9	Max WS	TR200 3H	6.49	6.38	8.31	7.40	8.41	0.001005	1.42	4.56	8.43	0.34
Fichi	11.9	Max WS	TR303H	6.47	6.38	8.29	7.40	8.39	0.001041	1.44	4.50	8.43	0.35
Fichi	11.5			Bridge									
Fichi	11.1	Max WS	TR200 3H	6.49	6.56	7.60	7.47	7.93	0.006626	2.52	2.57	3.53	0.81
Fichi	11.1	Max WS	TR303H	6.47	6.56	7.60	7.47	7.92	0.006624	2.52	2.57	3.53	0.81
Fichi	11	Max WS	TR200 3H	6.49	6.58	7.62	7.47	7.87	0.008120	2.21	2.94	3.55	0.77
Fichi	11	Max WS	TR303H	6.47	6.58	7.62	7.47	7.87	0.008117	2.20	2.94	3.55	0.77
Fichi	10.98			Lat Struct									
Fichi	10.97			Lat Struct									
Fichi	10	Max WS	TR200 3H	6.49	5.86	7.20	6.67	7.28	0.001849	1.27	5.12	5.09	0.40
Fichi	10	Max WS	TR303H	6.47	5.86	7.20	6.67	7.28	0.001852	1.27	5.11	5.08	0.40
Fichi	9.9	Max WS	TR200 3H	6.49	5.84	7.18	6.65	7.28	0.001606	1.39	4.68	5.06	0.41
Fichi	9.9	Max WS	TR303H	6.47	5.84	7.18	6.65	7.28	0.001608	1.39	4.67	5.06	0.41
Fichi	9.5			Bridge									
Fichi	9.1	Max WS	TR200 3H	6.49	5.64	6.43	6.35	6.69	0.007425	2.23	2.91	4.81	0.84
Fichi	9.1	Max WS	TR303H	6.47	5.64	6.43	6.35	6.68	0.007434	2.23	2.90	4.80	0.84
Fichi	9	Max WS	TR200 3H	6.49	5.63	6.43	6.34	6.65	0.007788	2.05	3.17	4.82	0.81
Fichi	9	Max WS	TR303H	6.47	5.63	6.43	6.34	6.65	0.007785	2.04	3.17	4.82	0.80
Fichi	8	Max WS	TR200 3H	6.49	3.69	5.07	4.81	5.23	0.004797	1.77	3.66	4.55	0.63
Fichi	8	Max WS	TR303H	6.47	3.69	5.07	4.80	5.23	0.004795	1.77	3.65	4.54	0.63
Fichi	7.98			Lat Struct									
Fichi	7.97			Lat Struct									
Fichi	7	Max WS	TR200 3H	6.33	3.03	4.38	4.09	4.52	0.003761	1.68	4.29	10.10	0.57
Fichi	7	Max WS	TR303H	6.32	3.03	4.38	4.09	4.52	0.003753	1.68	4.28	10.10	0.57
Fichi	6	Max WS	TR200 3H	6.08	2.33	3.53	3.37	3.73	0.006527	1.95	3.11	4.32	0.73
Fichi	6	Max WS	TR303H	6.07	2.33	3.53	3.37	3.73	0.006531	1.95	3.11	4.32	0.74
Fichi	5.9	Max WS	TR200 3H	6.08	2.30	3.55	3.01	3.67	0.001647	1.50	4.06	4.84	0.43
Fichi	5.9	Max WS	TR303H	6.07	2.30	3.55	3.01	3.66	0.001647	1.50	4.06	4.84	0.43
Fichi	5.5			Bridge									
Fichi	5.1	Max WS	TR200 3H	6.08	2.20	3.47	2.92	3.58	0.001545	1.50	4.06	5.38	0.42
Fichi	5.1	Max WS	TR303H	6.07	2.20	3.47	2.92	3.58	0.001547	1.50	4.06	5.38	0.43
Fichi	5	Max WS	TR200 3H	6.08	2.15	3.45	3.07	3.56	0.003055	1.47	4.12	4.91	0.51
Fichi	5	Max WS	TR303H	6.07	2.15	3.45	3.07	3.56	0.003056	1.47	4.12	4.91	0.51
Fichi	4	Max WS	TR200 3H	6.08	1.16	2.69	2.10	2.82	0.001567	1.58	3.85	5.46	0.43
Fichi	4	Max WS	TR303H	6.07	1.16	2.69	2.10	2.81	0.001580	1.58	3.84	5.45	0.43
Fichi	3.5			Bridge									
Fichi	3.1	Max WS	TR200 3H	6.08	1.39	2.64	2.14	2.78	0.001780	1.63	3.72	9.92	0.47
Fichi	3.1	Max WS	TR303H	6.07	1.39	2.63	2.14	2.77	0.001800	1.64	3.71	9.76	0.47
Fichi	3	Max WS	TR200 3H	6.08	1.42	2.70	2.00	2.75	0.000841	0.93	7.15	11.51	0.28
Fichi	3	Max WS	TR303H	6.07	1.42	2.70	2.00	2.74	0.000853	0.94	7.10	11.43	0.28
Fichi	2.98			Lat Struct									
Fichi	2.97			Lat Struct									
Fichi	2	Max WS	TR200 3H	4.61	0.82	2.63	1.62	2.65	0.000361	0.62	7.75	9.41	0.19
Fichi	2	Max WS	TR303H	5.01	0.82	2.62	1.65	2.64	0.000446	0.68	7.60	9.38	0.21
Fichi	1	Max WS	TR200 3H	3.93	0.91	2.59	1.62	2.61	0.000369	0.59	6.63	6.41	0.19
Fichi	1	Max WS	TR303H	4.59	0.91	2.55	1.69	2.58	0.000560	0.72	6.37	6.29	0.23

HEC-RAS River: Fosso dei Fichi Reach: Fichi Profile: Max WS (Continued)

Reach	River Sta	Profile	Plan	Q Total (m3/s)	Min Ch El (m)	W.S. Elev (m)	Crit W.S. (m)	E.G. Elev (m)	E.G. Slope (m/m)	Vel Chnl (m/s)	Flow Area (m2)	Top Width (m)	Froude # Chl
Fichi	0.9	Max WS	TR200 3H	3.93	0.42	2.60	1.13	2.61	0.000151	0.43	9.07	6.72	0.12
Fichi	0.9	Max WS	TR303H	4.59	0.42	2.56	1.19	2.57	0.000223	0.52	8.80	6.63	0.14

Reach	River Sta	Profile	Plan	Q US (m3/s)	Q Leaving Total (m3/s)	Q DS (m3/s)	Q Weir (m3/s)	Q Gates (m3/s)	Wr Top Width (m)	Weir Max Depth (m)	Weir Avg Depth (m)	Min El Weir Flow (m)	E.G. US. (m)	W.S. US. (m)	E.G. DS (m)	W.S. DS (m)
Fichi	12.98	Max WS	TR200 3H	32.24	21.90	6.49	21.90		122.34	0.51	0.21	8.05	10.37	9.35	8.40	8.36
Fichi	12.98	Max WS	TR303H	20.29	12.96	6.47	12.96		122.34	0.33	0.15	8.05	9.81	9.17	8.39	8.34
Fichi	12.97	Max WS	TR200 3H	32.24	3.85	6.49	3.85		55.17	0.28	0.10	8.21	10.37	9.35	8.40	8.36
Fichi	12.97	Max WS	TR303H	20.29	0.85	6.47	0.85		32.64	0.13	0.06	8.21	9.81	9.17	8.39	8.34
Fichi	10.98	Max WS	TR200 3H	6.49	0.00	6.49	0.00					8.02	7.87	7.62	7.28	7.20
Fichi	10.98	Max WS	TR303H	6.47	0.00	6.47	0.00					8.02	7.87	7.62	7.28	7.20
Fichi	10.97	Max WS	TR200 3H	6.49	0.00	6.49	0.00					7.98	7.87	7.62	7.28	7.20
Fichi	10.97	Max WS	TR303H	6.47	0.00	6.47	0.00					7.98	7.87	7.62	7.28	7.20
Fichi	7.98	Max WS	TR200 3H	6.49	0.22	6.08	0.22		41.14	0.04	0.02	3.96	5.23	5.07	3.73	3.53
Fichi	7.98	Max WS	TR303H	6.47	0.21	6.07	0.21		40.67	0.04	0.02	3.96	5.23	5.07	3.73	3.53
Fichi	7.97	Max WS	TR200 3H	6.49	0.20	6.08	0.20		38.05	0.04	0.02	4.05	5.23	5.07	3.73	3.53
Fichi	7.97	Max WS	TR303H	6.47	0.19	6.07	0.19		37.60	0.04	0.02	4.05	5.23	5.07	3.73	3.53
Fichi	2.98	Max WS	TR200 3H	6.08	0.07	3.93	0.07		17.56	0.03	0.02	2.67	2.75	2.70	2.61	2.60
Fichi	2.98	Max WS	TR303H	6.07	0.05	4.59	0.05		14.87	0.03	0.01	2.67	2.74	2.70	2.57	2.56
Fichi	2.97	Max WS	TR200 3H	6.08	2.08	3.93	2.08		102.15	0.10	0.05	2.53	2.75	2.70	2.61	2.60
Fichi	2.97	Max WS	TR303H	6.07	1.44	4.59	1.44		89.81	0.09	0.04	2.53	2.74	2.70	2.57	2.56